

Order on Notice B from the Danish Maritime Authority, technical regulation on the construction and equipment, etc. of ships

Pursuant to section 1(2), sections 2-5 and section 32 of the act on safety at sea, cf. consolidated act no. 903 of 12 July 2007, as enacted by decree no. 882 of 25 August 2008 on the entry into force for Greenland of the act on safety at sea, the following provisions are laid down following consultation with the Government of Greenland and by authority:

Section 1. This technical regulation shall apply to passenger ships engaged on international voyages, irrespective of size, and to cargo ships of 15 metres in length and above or with a scantling number of 100 or above, irrespective of whether they are engaged on domestic or international voyages, and recreational craft with a hull length above 24 m, unless otherwise stated in the individual chapters.

Subsection 2. Detailed regulations regarding the construction and equipment etc. of ships are published as annexes to this technical regulation, and the annexes consist of the following chapters:

B I		General provisions.
B II-1	A	Construction – structure, subdivision and stability, machinery and electrical installations. General provisions and construction.
B II-1	B	Construction – structure, subdivision and stability, machinery and electrical installations. Subdivision and stability.
B II-1	C	Construction – structure, subdivision and stability, machinery and electrical installations. Machinery.
B II-1	D	Construction – structure, subdivision and stability, machinery and electrical installations. Electrical installations.
B II-1	E	Construction – structure, subdivision and stability, machinery and electrical installations. Additional requirements concerning periodically unattended machinery spaces.
B II-1	N	Construction – structure, subdivision and stability, machinery and electrical installations. Refrigeration systems.
B II-2	A	Construction – Fire protection, fire detection and fire extinction. General provisions.
B II-2	B	Construction – Fire protection, fire detection and fire extinction. Prevention of fire and explosion.
B II-2	C	Construction – Fire protection, fire detection and fire extinction. Suppression of fire.
B II-2	D	Construction – Fire protection, fire detection and fire extinction. Escape.
B II-2	E	Construction – Fire protection, fire detection and fire extinction. Operational requirements.
B II-2	F	Construction – Fire protection, fire detection and fire extinction. Alternative design and arrangements.
B II-2	G	Construction – Fire protection, fire detection and fire extinction. Special requirements.
B II-2	N(1)	Construction – Fire protection, fire detection and fire extinction. CO ₂ fire extinguishing systems.
B II-2	N(2)	Construction – Fire protection, fire detection and fire extinction. Fire extinguishing systems with mixed atmospheric gases.

B II-2	N(3)	Construction – Fire protection, fire detection and fire extinction. Periodic surveys etc. of fire extinguishers.
B II-3		Accommodation, etc.
B II-4	A	Working spaces and workstations – arrangement and equipment.
B II-4	B	Central systems for welding with acetylene and oxygen.
B II-4	C	Installation and use of equipment for arc welding and allied processes.
B II-5		The Load Line Convention, 1966, as amended by the Protocol of 1988.
B II-5	A(I-I)	The Load Line Convention, 1966, as amended by the Protocol of 1988.
B II-5	A(I-II)	The Load Line Convention, 1966, as amended by the Protocol of 1988.
B II-5	A(I-III)	The Load Line Convention, 1966, as amended by the Protocol of 1988.
B II-5	A(I-IV)	The Load Line Convention, 1966, as amended by the Protocol of 1988.
B II-5	A(II)	The Load Line Convention, 1966, as amended by the Protocol of 1988.
B II-5	A(III)	The Load Line Convention, 1966, as amended by the Protocol of 1988.
B II-5	N	Load lines.
B III	A	Life-saving appliances and arrangements. General.
B III	B	Life-saving appliances and arrangements. Requirements for ships and life-saving appliances.
B III	C	Alternative design and arrangements.
B IV		Radiocommunications GMDSS.
B V		Safety of navigation.
B VI		Carriage of cargoes.
B VII		Carriage of dangerous goods.
B VIII		Nuclear ships.
B IX		Safe operation of ships.
B X		High-speed craft.
B XI		Special measures to enhance maritime safety.
B XII		Additional safety measures for bulk carriers.
B XIII-XX		Reserved
B XXI		Prevention of oil pollution from ships.
B XXII		Control of pollution by noxious liquid substances in bulk.

B XXIII	Prevention of pollution by harmful substances carried by sea in packaged form.
B XXIV	Treatment and storage of sewage.
B XXV	Prevention of pollution by garbage from ships.
B XXVI	Prevention of air pollution from ships.
B Appendix	Regulations that enter into force on 1 January 2011.
Annex 1 A	SOLAS certificates.
Annex 1 B	Load line certificates.
Annex 1 C	MARPOL certificates.
Annex 2	National certificates.

Section 2. The provisions of chapters I, II-1 (A-E), II-2 and III-XII are essentially based on the International Convention for the Safety of Life at Sea (SOLAS) 1974, as amended, and associated protocols, and Directive 2003/25/EC of the European Parliament and of the Council.

Subsection 2. Chapter II-5 A is formulated on the basis of the International Convention on Load Lines of 5 April 1966 (ILLC 66) together with the associated protocol of 1988 and Annex B to this protocol. Chapter II-5 N contains regulations which supplement or expand on the Convention and the Protocol of 1988 and regulations for ships less than 24 metres in length.

Subsection 3. The provisions of chapter II-3 on accommodation etc., parts I and II, are based on the international Accommodation of Crews Convention, ILO Convention no. 92 of 18 June 1949 and no. 133 of 30 October 1970.

Subsection 4. Chapters XXI, XXII, XXIII, XXIV, XXV and XXVI contain a number of provisions implementing those parts of the International Convention for the Prevention of Pollution from Ships, MARPOL 73/78 and its associated Protocol of 1997, which fall within the area of the Act on Safety at Sea. These provisions are marked with an "S". In addition, the mentioned chapters also contain a translation of the part of the Convention which solely relates to the Act on Protection of the Marine Environment. The translation is marked with an "M" for each rule. These provisions are only included for informative purposes. The regulations which implement these parts of the Convention into Danish legislation are issued by the Minister for the Environment within the framework of the Act on Protection of the Marine Environment. Some of the regulations in the Convention regard matters which fall under the Act on Safety at Sea as well as the Act on Protection of the Marine Environment. These regulations are marked with "S/M".

Subsection 5. Danish regulations supplementing or extending the provisions of the SOLAS, ILLC 66 and MARPOL Conventions are printed in italics.

Section 3. A copy of this technical regulation shall be found on board passenger ships engaged on international voyages and cargo ships of 15 metres in length and above or with a scantling number of 100 or above. This does not preclude the use of the electronic medium provided that the technical regulation can be read on board.

Penalties, measures and entry into force, etc.

Section 4. Contravention of this regulation shall be punished with a fine or imprisonment of up to one year.

Subsection 2. The penalty may increase to imprisonment for up to 2 years, if

- 1) the contravention has caused harm to life or health or led to the risk thereof,
- 2) a ban or order has previously been issued regarding the same or equivalent circumstances, or
- 3) the contravention resulted in, or was intended to result in, financial gain for the party concerned or for others.

Subsection 3. If the profits gained through the contravention are not confiscated, particular consideration shall be given to the size of the financial gain or intended financial gain when meting out any fine, including any supplementary fine.

Subsection 4. Criminal liability may be incurred by companies, etc. (legal entities) in accordance with the rules of chapter 5 of the Penal Code.

Section 5. If the circumstance is covered by the Decree concerning the entry into force for Greenland of the act on safety at sea, measures may be prescribed pursuant to the Criminal Code for Greenland.

Subsection 2. The circumstances referred to in Section 4(2) shall be regarded as aggravating circumstances.

Subsection 3. If the profits gained through the contravention are not confiscated, cf. section 116(1) of the Penal Code, particular consideration shall be given to the size of the financial gain or intended financial gain when meting out the fine, including supplementary fines.

Subsection 4. If a contravention is committed by companies, etc. (legal entities), liability to pay a fine may be incurred by the legal entity as such. If the contravention is committed by the State, Greenland's Home Rule, a municipality, an inter-municipal enterprise covered under Section 64 of the Landsting Act on municipal councils and local authorities, etc. or a local authority, the relevant public authority as such shall be liable to punishment by fine.

Subsection 5. If the relevant party is not resident in Greenland, or their connection to Greenland society is otherwise so remote that the prerequisites for the application of the measures do not exist, proceedings may be instigated or the case sent for trial in Denmark.

Section 6. This technical regulation shall enter into force on 1 July 2010.

Subsection 2. The structural requirements in the previous provisions of the annex entitled "Appendix" shall enter into force on 1 January 2011.

Subsection 3. The structural requirements of the previous provisions shall continue to apply to existing ships, unless otherwise provided in this technical regulation.

Notice B from the Danish Maritime Authority								
Chapter dates from 21 October 1991								
Date of signature	21/10-91	21/1-93	15/7-93	6/12-93	19/9-94	28/11-95	29/5-96	10/12-96
B I	7/1-91	15/11-91			3/1-94			
B II-1 A	7/1-91				3/1-94			
B II-1 B1	7/1-91	15/11-91			3/1-94			
B II-1 B2	7/1-91	15/11-91						
B II-1 C	7/1-91				3/1-94			
B II-1 D and E	7/1-91	15/11-91			3/1-94			
B II_1 N(1)								
B II-2 A1	7/1-91	15/11-91			1/8-94			1/1-97
B II-2 A2	7/1-91	15/11-91			1/8-94			
B II-2 B	7/1-91	15/11-91			1/8-94			1/1-97
B II-2 C	7/1-91	15/11-91						
B II-2 D	7/1-91	15/11-91	15/3-93		1/8-94			
B II-2 A and B								
B II-2 C								
B II-2 D and E								
B II-2 F and G								
B II-2 N(1)								
B II-2 N(2)								
B II-2 N(3)								
B II-3	7/1-91							
B II-4 A								
B II-4 B								
B II-4 C								
B II-5 A1					3/1-94			
B II-5 A2					3/1-94			
B II-5 A3					3/1-94			
B II-5 N	7/1-91							

B II-2 G	1/8-09	1/7-10					
B II-2 N(1)		1/7-10					
B II-2 N(2)							
B II-2 N(3)							
B II-3		1/7-10					
B II-4 A							
B II-4 B							
B II-4 C							
B II-5							
B II-5 A(I-I)		1/7-10					
B II-5 A(I-II)							
B II-5 A(I-III)							
B II-5 A(I-IV)							
B II-5 A(II)							
B II-5 A(III)							
B II-5 N							
B III A		1/7-10					
B III B	1/8-09	1/7-10					
B III C		1/7-10					
B IV GMDS	1/8-09	1/7-10					
B V	1/8-09		1/1-11				
B VI	1/8-09		1/1-11				
B VII			1/1-11				
B VIII							
B IX	1/8-09	1/7-10					
B X							
B XI A	1/8-09						
B XI B	1/8-09						
B XII							
B XXI	1/8-09	1/7-10					
B XXII							
B XXIII	1/8-09						
B XXIV		1/7-10					
B XXV							
B XXVI		1/7-10	1/1-11				
Annex 1 A	1/8-09		1/1-11				
Annex 1 B							
Annex 1 C		1/7-10	1/1-11				
Annex 2							

*) Date of digital promulgation of Notice B from the Danish Maritime Authority.

**) Found in the Annex entitled "Appendix"

Discontinued chapters:

Date of signature	B II-1 A and B	B II-1 E and F	B II-4	B III C1	B III C2	B IV	B XI
21/10-91		7/1-91	7/1-91			7/1-91	
21/1-93							
15/7-93							
6/12-93			2)	3)	3)	1)	
19/9-94							
28/11-95							
29/5-96							
10/12-96							
26/6-97							
16/6-98		1)	2)	3)	3)	1)	

7/5-99							
11/12-00							
19/7-01							4)
12/12-01							
19/4-02							
14/3-08	6)						

Notes to the tables:

- 1) Chapter B II-1 E has been incorporated at the back of chapter II-1 D of 1 July 1998, and chapter B II-1 F is discontinued. Chapter B IV, Radio telegraphy and radio telephony, is discontinued.
- 2) Chapter B II-4 on noise has now been replaced by similar provisions in Notice A from the Danish Maritime Authority.
- 3) As of 1 July 1998, the content of chapter III has been changed and now it is published as two chapters. Previous chapters II C 1 and C 2, which contained functional requirements for life-saving appliances, have been replaced by the International Life-Saving Appliances Code (LSA Code), Resolution MSC.48(66), cf. regulation 4 of chapter III.
- 4) Chapter B XI on special measures to enhance maritime security has now been replaced by chapter B XI-1.
- 5) In 2003, chapter XX changed into chapter XXIV, and chapter XXIV changed into chapter XXV.
- 6) Chapter I-1 A and B is repealed and re-issued as a consequence of the revision and harmonisation of the damage stability chapter in accordance with Resolution MSC.261(82).

The Danish Maritime Authority, 10 May 2010

Per Sønderstrup / Jeppe Skovbakke Juhl

Technical regulation on the construction and equipment etc. of ships

Introduction

Notices from the Danish Maritime Authority consist of a short technical regulation and a number of annexes in the form of chapters. The technical regulation contains the statutory basis, the application, the penalty and entry into force clauses and a list of the most recent revisions of each individual chapter. Together the annexes and the annex parts form a consolidated version of Notice B from the Danish Maritime Authority which reflects the regulations in force on the entry into force date.

When future amendments are made to individual chapters, a new consolidated version will be issued, which will be enacted by the issuance of a new technical regulation.

Unless otherwise specified in each individual chapter, existing ships shall only comply with the structural requirements in force when the ship was constructed. However, derogations from this may be specified in regulations issued subsequently.

The technical regulation is followed by an overview of the chapters dating from the first issuance in 1991. From 1991 to 2008, the overview refers to previously issued chapter booklets. From 2009, the date of the chapters is made in relation to the main parts of the chapters.

Amended chapters

Chapter I – General provisions

In regulation 10, a minor clarification has been made as regards the five-year bottom survey for cargo ships.

Chapter II-1 – Subdivision and stability

In part II-1 A, a minor clarification has been made as regards regulation 3-4 on emergency towing arrangements on tankers.

With the updating of the part on ships' intact stability, the Danish Maritime Authority has made the new revised Code on Intact Stability mandatory for all ships.

In part II-1 D, regulation 4, a provision has been added requiring supplementary lighting to be available in all cabins for new passenger ships, clearly indicating the exit so that it is possible for the persons in the cabin to find their way to the door. Such lighting shall give out light automatically when the power for the ordinary supply is lost.

A new regulation 55 has been inserted in part II-1 F on alternative design and arrangements in connection with machinery and electrical installations. This regulation makes it possible to use alternative design and arrangements if they meet the intention behind the relevant requirements and present an equivalent level of safety.

Chapter II-2 A – Construction – General provisions

Minor editorial amendments have been made in this part.

Chapter II-2 C – Construction – suppression of fire

Amendments have been introduced as regards the fire integrity requirement for doors of Class A and B concerning the opening below the door. The requirements apply to doors installed on or after 1 July 2010.

In regulation 7, new requirements for fire-detection systems in passenger ships are inserted so that it is possible to identify all fire-detectors and fire-pressures individually and so that it is possible for fire-detectors in cabins to sound an audible alarm in each individual cabin.

In addition, new requirements for ventilation ducts of steel or equivalent material are introduced as regards flame spread and calorific value.

In regulation 9, new requirements for fire-protection in atriums concerning fire-doors approved without the threshold being a part of the door frame are introduced. Finally, there are new requirements for ventilation ducts.

The previous Danish special regulations in regulation 10 on compressors for recharging fire-fighters' breathing air cylinders in passenger ships will become international in new passenger ships and will continue to apply to existing passenger ships.

Minor editorial amendments and updates have been made in note references.

Chapter II-2 G – Construction – special requirements

New requirements are introduced for passenger ships' possibility of returning to a safe port or place of refuge, on systems that are to remain capable of operating after a fire incident and on safety centres.

Furthermore, minor editorial amendments have been made, and note references have been updated.

Chapter II-2 (N(1) – High-pressure CO₂ systems

The revised chapter on CO₂ systems in the Fire Safety Systems Code (FSS Code) provides the user with an improved overview of the Code's requirements as well as the Danish special regulations on CO₂ systems.

Chapter III – Life-saving appliances and arrangements

A new regulation 38 has been inserted the purpose of which is to bring about a methodology for alternative design and alternative arrangements in connection with life-saving appliances and arrangements. Instead, the alternative design is to be subjected to a technical analysis in accordance with the "Guidelines on alternative design and arrangements for SOLAS chapters II-1 and III" (MSC.1/Circ.1212).

Chapter IV – Radiocommunications GMDSS

The previous mandatory requirement for a radio log in regulation IV/17 has been deleted. In the future, it is voluntary whether radio recordings are entered in the ship's log or in a radio log.

Furthermore, a number of editorial amendments have been made as regards Inmarsat earth stations in regulations 7, 9 and 10.

Chapter IX – Safe operation of ships

Minor editorial amendments have been made as well as an update following resolution A.1022(26).

Chapter XXI – Prevention of oil pollution from ships

Editorial amendments have been made in this chapter as a consequence of an amendment of the oil residue (sludge) definition.

Chapter XXIV – Prevention of pollution by sewage from ships

Minor editorial amendments have been made in this chapter clarifying that sewage from animals is also covered by these provisions.

Chapter XXVI – Prevention of air pollution from ships

The most extensive amendments in this chapter are stricter requirements on the discharge of SO_x and NO_x. These requirements become gradually stricter. The first new requirements for stricter SO_x discharges enter into force on 1 July 2010 in the special emission control areas, while the first stricter requirements for NO_x discharges will enter into force on 1 January 2011. The related IAPP certificates are also amended.

In addition, more lenient requirements have been introduced as regards the designation of the special emission control areas, which means that, in the future, more such areas are expected.

Furthermore, it should be added that the technical NO_x Code (which does not form part of Notices B) has also been revised. The related EIAPP certificate has also been amended.

Annex Appendix – Regulations entering into force as of 1 January 2011

This part contains regulations entering into force on 1 January 2011, which will not be incorporated into the text until the publication of the spring 2011 edition.

Chapter II-1 – Sub-division and stability

Minor clarifications have been made in the text.

Chapter II-2 G – Construction – special requirements

There are minor amendments and clarifications in regulation 19 in general and in table 19.3 especially, where new columns have been introduced under classes 2.3 and 4.3, which are subdivided into liquids and solids.

Chapter V – Safety of navigation

Amendments of this chapter have been made on the basis of resolution MSC.282(86). *Excepted is the resolution's addition of regulations 19.2.2.3 and 19.2.2.4 on a bridge navigation watch alarm system (BNWAS). This text as well as the text in regulation 19.1.2.4 is the national requirement for a bridge navigation watch alarm system of 1 March 2006. At the same time, the previous text as regards the national requirement for a bridge navigation watch alarm system in regulation 19.7 has been deleted.*

Furthermore, a new requirement has been introduced in the chapter for an electronic chart and display information system (ECDIS) in the new regulations 19.2.10 and 19.2.11. In this connection, the text of regulation 19.2.1.4 has been amended, and an editorial amendment has been made in regulation 18.4.

Chapter VI – Carriage of cargoes

There are several amendments of this chapter for which reason a revised chapter has been inserted.

Chapter VII – Carriage of dangerous cargoes

The amendments to this chapter will enter into force (internationally) on 1 January 2011. Considering the provisions on the Baltic Sea MoU, shipowners are urged to meet the provisions as soon as possible.

The chapter is amended in order to implement the International Maritime Solid Bulk (IMSBC) Code, laying down guidelines for the carriage of hazardous solids carried in bulk. The application of the Baltic Sea agreement as an alternative to the IMDG Code when carrying dangerous goods on ro-ro ships in the Baltic Sea area and the preconditions for this have been clarified. In this connection, drivers are prescribed to guarantee declarations on dangerous goods. Furthermore, the regulations on old gas tankers have been updated. Finally, the footnotes in the chapter have been updated.

Chapter XXI – Prevention of oil pollution from ships

In this chapter, an appendix containing a new part VIII has been introduced. As a consequence of the new regulations, consequential amendments will be made in the IOPP certificate as well as the Oil Record Book. The appendix contains the new certificate, and the Oil Record Book will be published before the entry into force of the new regulations.

The new regulations concern stricter requirements for STS operations.

Annex 1 A – SOLAS certificates

Minor editorial amendments have been made to this part as a consequence of the amendments of chapter V on the implementation of bridge navigation watch alarm systems.

Annex 1 C – MARPOL certificates

The IOPP certificate has been amended as a consequence of the amendments to chapter XXI on the prevention of oil pollution by ships.

Annex 1 C – MARPOL certificates

The IAPP certificate has been amended as a consequence of the amendments of chapter XXVI on the prevention of air pollution by ships.

Notice from the Danish Maritime Authority B – The Construction and Equipment, etc. of Ships

Chapter B I

General Provisions

Regulation 1 – Application	2
Regulation 2 – Definitions	2
Regulation 3 – Exceptions	3
Regulation 4 – Exemptions	4
Regulation 5 – Equivalents	4
Regulation 6 - Inspection and surveys	5
<i>Regulation 6-1 – Special surveys and survey intervals</i>	6
Regulation 7 – Surveys of passenger ships	6
Regulation 8 – Surveys of life-saving appliances and other equipment of cargo ships <i>with a gross tonnage of 500 and upwards</i>	7
<i>Regulation 8-1 – Survey of life-saving appliances and other equipment of cargo ships with a gross tonnage of less than 500</i>	8
Regulation 9 – Surveys of radio installations of cargo ships of 300 gross tonnage and above.....	9
<i>Regulation 9-1 – Surveys of radio installations of cargo ships of less than 300 gross tonnage</i>	9
Regulation 10 – Surveys of structure, machinery and equipment of cargo ships <i>with a gross tonnage of 500 and upwards</i>	9
<i>Regulation 10-1 – Surveys of structure, machinery and equipment of cargo ships with less than 500 gross tonnage</i>	11
Regulation 11 – Maintenance of conditions after survey	11
Regulation 12 – Issue or endorsement of certificates	12
<i>Regulation 12-1 – Issue of certificates for cargo ships with a gross tonnage of less than 500</i>	13
Regulation 13 – Issue or endorsement of certificates by another Government	14
Regulation 14 – Duration and validity of certificates	14
<i>Regulation 14-1 – Duration and validity of certificates in cargo ships with a gross tonnage of less than 500</i>	16
Regulation 15 – Forms of certificates and records of equipment	16
<i>Regulation 15-1 – Form of certificates and records of equipment for cargo ships with a gross tonnage of less than 500</i>	17
Regulation 16 – Availability of certificates	17
Regulation 17 – Acceptance of certificates.....	17
Regulation 18 – Qualification of certificates	17
Regulation 19 – Control.....	17
Regulation 20 – Privileges	18
Regulation 21 – Casualties.....	18
<i>Regulation 22 – Annexed file</i>	18
<i>Regulation 23 – General safety</i>	19

Part A – Application, definitions etc.

Regulation 1 – Application

- (a) Unless expressly provided otherwise, the present *set of regulations* shall apply to *passenger ships, irrespective of size, engaged on international voyages and cargo ships with a length (L) of 15 m and above or with a scantling number of 100 or above, irrespective of whether they are engaged on domestic or international voyages, cf. however the exemptions in regulation 3.*
- (b) The classes of ships to which each chapter applies are more precisely defined, and the extent of the application is shown, in each chapter.
- (c) *Chapter I shall apply to new and existing ships (cf. the definition in regulation 2(k) and (l).*
- (d) *If the design or application of a cargo ship deviates from the principles on which the drafting of this set of regulations is based, or if the number of persons working on board the ship exceeds the crew carrying out the ship's normal navigation, on-going maintenance, operation of machinery and mess services, etc. by more than 12 persons, this shall be taken into account when designing, equipping and operating the ship so that it is ensured that the ship complies with the provisions of section 2 of the Act on Safety at Sea. In this connection, the Danish Maritime Authority may make the issuance of a trade permit conditional upon the ship's partial or full compliance with the rules applying to passenger ships.*

Regulation 2 – Definitions

For the purpose of the present regulations, unless expressly provided otherwise:

- (a) “Regulations” means the regulations contained in the annex to the present Convention (SOLAS 74).
- (b) “Administration” means the Government of the State whose flag the ship is entitled to fly. *In the case of Danish ships, the Administration is the Danish Maritime Authority unless otherwise provided.*
- (c) “Approved” means approved by the Administration.¹⁾
- (d) “International voyage” means a voyage from a country to which the present Convention (SOLAS 74) applies to a port outside such country, or conversely. *Voyages between Denmark and the Faeroes and between Denmark and Greenland as well as voyages between the Faeroes and Greenland or between two foreign ports are regarded as international voyages.*
- (e) A “passenger” is every person other than:
 - (i) the master and the members of the crew or other persons employed or engaged in any capacity on board a ship on the business of that ship; and
 - (ii) a child under one year of age.
- (f) A “passenger ship” is a ship which carries more than twelve passengers.
- (g) A “cargo ship” is any ship which is not a passenger ship *or a fishing vessel.*
- (h) A “tanker” is a cargo ship constructed or adapted for the carriage in bulk of liquid cargoes of an inflammable nature.
- (i) A “fishing vessel” is a vessel used for catching fish, whales, seals, walrus or other living resources of the sea, *or which is subject to Notice E from the Danish Maritime Authority.*

¹⁾ *The Danish Maritime Authority shall accept calculations and tests that have been carried out by approved testing bodies, including testing bodies in other EU member States as well as in countries signatory to the EEA Agreement, which provide appropriate and satisfactory guarantees of the technical, professional and independent nature of the tests.*

Equipment that has been deemed to be compliant and is wheelmarked in accordance with Council Directive 96/98/EC of 20 December 1996 on marine equipment, as amended, which entered into force on 1 January 1999, shall be approved. See Technical Regulation on marine equipment, which transposes Council Directive 96/98/EC.

- (j) A “nuclear ship” is a ship provided with a nuclear power plant.
- (k) “New ship” means a *passenger or cargo* ship the keel of which is laid or which is at a similar stage of construction on or after 25 May 1980. *For cargo ships of less than 500 gross tonnage, a new ship is a ship the keel of which is laid on or after 1 January 2002.*
- (l) “Existing ship” means a ship which is not a new ship.
- (m) A “mile” is 1,852 m or 6,080 ft.
- (n) “Anniversary date” means the day and the month of each year which will correspond to the date of expiry of the relevant certificate.
- (o) “Organisation” means the *International Maritime Organization (IMO)*.
- (p) “Parties” means *countries which have acceded to SOLAS 74 and associated Protocol of 1978.*
- (q) “Classification society” means *an organisation recognised by the Danish Maritime Authority in accordance with the provisions of chapter XI, regulation 1.*²
- (r) “Length L1” means *the length measured from the foreside of the intersection of the plating with the topside of the deck at the stem to the after side of the intersection of the plating with the deck at the stern.*
- (s) “Scantling number” is *the length L1 multiplied by the maximum breadth B of the ship as stated in the ship’s tonnage certificate.*³
- (t) “Gross tonnage” means *the gross tonnage (GT) measured in accordance with provisions in force concerning tonnage measurement of ships; in the case of ships with a length of 24 metres and above, in accordance with the International Convention of Tonnage Measurement of Ships, 1969. In the case of ships built before 18 July 1994 which were measured in accordance with tonnage measurement rules in force before the International Convention on Tonnage Measurement of Ships, 1969, entered into force, and where this tonnage is indicated in the international tonnage certificate (1969), this gross tonnage shall be used in connection with these provisions. In the case of ships of less than 24 metres in length which are only measured in accordance with the tonnage measurement rules (1947) previously in force, the gross registered tonnage (GRT) shall be used.*
- (u) “Recreational craft” means *a vessel which, irrespective of the means of propulsion, is used for sport or recreational purposes, and which is not used for commercial purposes, cf. Notice L from the Danish Maritime Authority on the construction and equipment, etc. of recreational craft.*
- (v) “Length (L)” shall be taken as *96% of the total length on a waterline at 85% of the least moulded depth measured from the keel line, or as the length from the foreside of the stem to the axis of the rudder stock on that waterline, if that be greater. In ships designed with a rake of keel, the waterline on which this length is measured shall be parallel to the designed waterline.*⁴

Regulation 3 – Exceptions

- (a) The present regulations (*cf. regulation 2 (a)*), unless expressly provided otherwise, do not apply to:
 - (i) Ships of war and troopships.
 - (ii) Cargo ships with a length (L) of less than 15 metres and a scantling number of less than 100.
 - (iii) Ships not propelled by mechanical means.

² Refer to the *Technical Regulation on the recognition and authorisation of organisations carrying out inspections and surveys of ships in force at any particular time.*

³ Cf. *Order no. 845 of 1 December 1998 on the measurement of small ships.*

⁴ Cf. *the definition of length in chapter II-5 Article 2.*

- (iv) Wooden ships of primitive build.
 - (v) Pleasure yachts, *the keel of which was laid before 1 January 2004, and pleasure yachts with a hull length of 24 metres or less, the keel of which was laid on or after 1 January 2004*, not engaged in trade.
 - (vi) Fishing vessels.
- b) Except as expressly provided in chapter V, nothing herein shall apply to ships solely navigating the Great Lakes of North America and the River St Lawrence as far east as a straight line drawn from Cap des Rosiers to West Point, Anticosti Island and, on the north side of Anticosti Island, the 63rd meridian.

Regulation 4 – Exemptions⁵⁾

- (a) A ship which is not normally engaged on international voyages but which, in exceptional circumstances, is required to undertake a single international voyage may be exempted by the Administration from any of the requirements of the present regulations provided that it complies with safety requirements which are adequate in the opinion of the Administration for the voyage which is to be undertaken by the ship.
- (b) The Administration may exempt any ship which embodies features of a novel kind from any of the provisions of chapters II-1, II-2, III and IV of these regulations the application of which might seriously impede research into the development of such features and their incorporation in ships engaged on international voyages. Any such ship shall, however, comply with safety requirements which, in the opinion of that Administration, are adequate for the service for which it is intended and are such as to ensure the overall safety of the ship and which are acceptable to the Governments of the States to be visited by the ship. The Administration which allows any such exemption shall communicate to the Organization particulars of same and the reasons therefore which the Organization shall circulate to the Contracting Governments for their information.
- (c) *In connection with drawing approval and the first survey of ships with a length of less than 24 metres, the Danish Maritime Authority may, after a concrete assessment, exempt ships from one or more of the provisions of this set of regulations. The precondition is that the ship complies with similar safety requirements which may, at the discretion of the Administration, suffice for ships of this size and engaged in the service area for which the ship is intended.*
- (d) *The Danish Maritime Authority may exempt individual ships, completely or in part, from undergoing the surveys that are not laid down in the international conventions applying to Denmark. This is conditional upon it being established that the use of materials, designs, arrangements, methods of working or control systems other than those prescribed provides a level of safety that is at least as effective as if the survey in question was carried out.*

Regulation 5 – Equivalent

- (a) Where the present regulations require that a particular fitting, material, appliance or apparatus, or type thereof, shall be fitted or carried in a ship, or that any particular provision shall be made, the Administration may allow any other fitting, material, appliance or apparatus, or type thereof, to be fitted or carried, or any other provision to be made in that ship, if it is satisfied by trial thereof or otherwise that such fitting, material, appliance or apparatus, or type thereof, or provision, is at least as effective as that required by the present regulations.

⁵⁾ Refer to SLS.14/Circ.115, as amended, on the issue of exemption certificates under the 1974 SOLAS Convention and amendments thereto

- (b) Any Administration which so allows, in substitution, a fitting, material, appliance or apparatus, or type thereof, or provision, shall communicate to the Organization particulars thereof together with a report on any trials made and the Organization shall circulate such particulars to other Contracting Governments for the information of their officers.

Part B – Surveys and certificates^{6) 7)}

Regulation 6 - Inspection and surveys

- (a) The inspection and survey of ships, so far as regards the enforcement of the provisions of the present regulations and the granting of exemptions therefrom, shall be carried out by officers of the Administration. The Administration may, however, entrust the inspections and surveys either to surveyors nominated for the purpose or to organizations recognized by it.
- (b) An Administration nominating surveyors or recognizing organizations to conduct inspections and surveys as set forth in paragraph (a) shall as a minimum empower any nominated surveyor or recognized organization to:
- (i) require repairs to a ship;
 - (ii) carry out inspections and surveys if requested by the appropriate authorities of a port State.

The Administration shall notify the Organization of the specific responsibilities and conditions of the authority delegated to nominated surveyors or recognized organizations.

- (c) When a nominated surveyor or recognized organization determines that the condition of the ship or its equipment does not correspond substantially with the particulars of the certificate or is such that the ship is not fit to proceed to sea without danger to the ship, or persons on board, such surveyor or organization shall immediately ensure that corrective action is taken and shall in due course notify the Administration. If such corrective action is not taken the relevant certificate should be withdrawn and the Administration shall be notified immediately; and, if the ship is in the port of another Party, the appropriate authorities of the port State shall also be notified immediately. When an officer of the Administration, a nominated surveyor or a recognized organization has notified the appropriate authorities of the port State, the Government of the port State concerned shall give such officer, surveyor or organization any necessary assistance to carry out their obligations under this regulation. When applicable, the Government of the port State concerned shall ensure that the ship shall not sail until it can proceed to sea, or leave port for the purpose of proceeding to the appropriate repair yard, without danger to the ship or persons on board.
- (d) In every case, the Administration shall fully guarantee the completeness and efficiency of the inspection and survey, and shall undertake to ensure the necessary arrangements to satisfy this obligation.
- (e)
- (i) *Every ship shall, before being put into service as a new-building, be approved by the Danish Maritime Authority following a prior survey.*

⁶⁾ Refer to "Global and uniform implementation of the harmonized system of survey and certification (HSSC)" and to the "Survey guidelines under the harmonized system of survey and certification" adopted by the Organization by resolutions A.883(21) and A.948(23) respectively.

⁷⁾ *In addition to the surveys and certificates in this chapter, which refer to the SOLAS 74 Convention, as amended, this set of regulations also contains requirements concerning surveys and certificates in other chapters, including chapters II-3, II-5, XXI, XXII, XXIV and XXVI, and in Codes to which the set of regulations refers.*

- (ii) *Every ship, shall before being put into service as a ship purchased from abroad, be approved by the Danish Maritime Authority following a prior survey. In this connection, the Danish Maritime Authority shall also assess whether the ship meets the general requirements in section 2 of the Act. This assessment shall not, however, be carried out for aspects that are covered by Regulation (EC) no. 789/2004 of 21 April 2004 on the transfer of cargo and passenger ships between registers within the Community.*
- (f) *No passenger ship may be put into service without the permit for sailing with passengers referred to in subparagraph 12(a)(i), sail outside the area of operation stated in the permit nor set sail with more passengers on board than stated therein.*
- (g) *Ships may not sail if the validity of a certificate issued by the Danish Maritime Authority, or on its behalf, has expired, or if a prescribed survey has not been carried out.*

Regulation 6-1 – Special surveys and survey intervals

- (a) *The Danish Maritime Authority may at any time order a ship to undergo an extraordinary survey, and similarly, under exceptional circumstances, it may set survey intervals which differ from those contained in regulations 8-1, 9-1 and 10-1 of this chapter.*
- (b) *In the case of a ship that has been taken out of service, the Danish Maritime Authority may permit prescribed periodical surveys to be wholly or partly omitted, provided the ship remains out of service.*

Regulation 7 – Surveys of passenger ships⁸⁾

- (a) A passenger ship shall be subject to the surveys specified below:
 - (i) an initial survey before the ship is put in service;
 - (ii) a renewal survey once every 12 months, except where regulation 14(b), (e), (f) and (g) is applicable;
 - (iii) additional surveys, as occasion arises.
- (b) The surveys referred to above shall be carried out as follows:
 - (i) the initial survey shall include a complete inspection of the ship's structure, machinery and equipment, including the outside of the ship's bottom and the inside and outside of the boilers. This survey shall be such as to ensure that the arrangements, materials and scantlings of the structure, boilers and other pressure vessels and their appurtenances, main and auxiliary machinery, electrical installation, radio installations including those used in lifesaving appliances, fire protection, fire safety systems and appliances, life-saving appliances and arrangements, shipborne navigational equipment, nautical publications, means of embarkation for pilots and other equipment fully comply with the requirements of the present regulations, and of the laws, decrees, orders and regulations promulgated as a result thereof by the Administration for ships of the service for which it is intended. The survey shall also be such as to ensure that the workmanship of all parts of the ship and its equipment is in all respects satisfactory, and that the ship is provided with the lights, shapes, means of making sound signals and distress signals as required by the provisions of the present regulations and the International Regulations for Preventing Collisions at Sea in force;
 - (ii) the renewal survey shall include an inspection of the structure, boilers and other pressure vessels, machinery and equipment, including the outside of the ship's bottom. The survey shall be such as to ensure that the ship, as regards the structure, boilers and other pressure

⁸⁾ Refer to resolution A.794(19), Surveys and inspections of ro-ro passenger ships and MSC/Circ. 956, Guidelines for unscheduled inspections of ro-ro passenger ships by flag States.

vessels and their appurtenances, main and auxiliary machinery, electrical installation, radio installations including those used in life-saving appliances, fire protection, fire safety systems and appliances, life-saving appliances and arrangements, shipborne navigational equipment, nautical publications, means of embarkation for pilots and other equipment is in satisfactory condition and is fit for the service for which it is intended, and that it complies with the requirements of the present regulations and of the laws, decrees, orders and regulations promulgated as a result thereof by the Administration. The lights, shapes, means of making sound signals and distress signals carried by the ship shall also be subject to the abovementioned survey for the purpose of ensuring that they comply with the requirements of the present regulations and of the International Regulations for Preventing Collisions at Sea in force;

(iii) an additional survey either general or partial, according to the circumstances, shall be made after a repair resulting from investigations prescribed in regulation 11, or whenever any important repairs or renewals are made. The survey shall be such as to ensure that the necessary repairs or renewals have been effectively made, that the material and workmanship of such repairs or renewals are in all respects satisfactory, and that the ship complies in all respects with the provisions of the present regulations and of the International Regulations for Preventing Collisions at Sea in force, and of the laws, decrees, orders and regulations promulgated as a result thereof by the Administration;

(c)

(i) the laws, decrees, orders and regulations referred to in paragraph (b) of this regulation shall be in all respects such as to ensure that, from the point of view of safety of life, the ship is fit for the service for which it is intended;

(ii) they shall among other things prescribe the requirements to be observed as to the initial and subsequent hydraulic or other acceptable alternative tests to which the main and auxiliary boilers, connections, steam pipes, high pressure receivers and fuel tanks for internal combustion engines are to be submitted including the test procedures to be followed and the intervals between two consecutive tests.

Regulation 8 – Surveys of life-saving appliances and other equipment of cargo ships *with a gross tonnage of 500 and upwards*

(a) The life-saving appliances and other equipment of cargo ships of 500 gross tonnage and upwards as referred to in paragraph (b)(i) shall be subject to the surveys specified below:

(i) an initial survey before the ship is put in service;

(ii) a renewal survey at intervals specified by the Administration but not exceeding 5 years, except where regulation 14(b), (e), (f) and (g) is applicable;

(iii) a periodical survey within three months before or after the second anniversary date or within three months before or after the third anniversary date of the Cargo Ship Safety Equipment Certificate which shall take the place of one of the annual surveys specified in paragraph (a)(iv);

(iv) an annual survey within 3 months before or after each anniversary date of the Cargo Ship Safety Equipment Certificate;

(v) an additional survey as prescribed for passenger ships in regulation 7(b)(iii).

(b) The surveys referred to in paragraph (a) shall be carried out as follows:

(i) the initial survey shall include a complete inspection of the fire safety systems and appliances, life-saving appliances and arrangements except radio installations, the shipborne navigational equipment, means of embarkation for pilots and other equipment to which chapters II-1, II-2, III and V apply to ensure that they comply with the

requirements of the present regulations, are in satisfactory condition and are fit for the service for which the ship is intended. The fire control plans, nautical publications, lights, shapes, means of making sound signals and distress signals shall also be subject to the abovementioned survey for the purpose of ensuring that they comply with the requirements of the present regulations and, where applicable, the International Regulations for Preventing Collisions at Sea in force;⁹⁾

- (ii) the renewal and periodical surveys shall include an inspection of the equipment referred to in paragraph (b)(i) to ensure that it complies with the relevant requirements of the present regulations and the International Regulations for Preventing Collisions at Sea in force, is in satisfactory condition and is fit for the service for which the ship is intended;
 - (iii) the annual survey shall include a general inspection of the equipment referred to in paragraph (b)(i) to ensure that it has been maintained in accordance with regulation 11(a) and that it remains satisfactory for the service for which the ship is intended.
- (c) The periodical and annual surveys referred to in paragraphs (a)(iii) and (a)(iv) shall be endorsed on the Cargo Ship Safety Equipment Certificate.

Regulation 8-1 – Survey of life-saving appliances and other equipment of cargo ships with a gross tonnage of less than 500

- (a) *Life-saving appliances and other equipment in cargo ships of 250 gross tonnage and upwards, but less than 500, as referred to in subparagraph (c)(i), shall undergo the following surveys:*
- (i) *An initial survey before the ship is put into service.*
 - (ii) *A renewal survey at intervals not exceeding 5 years.*
 - (iii) *An intermediate survey within 3 months after the 2nd anniversary date and within 3 months before the 3rd anniversary date of the Cargo Ship Safety Equipment Certificate. (Not less than 27 and not more than 33 months after the initial survey or last renewal survey).*
- (b) *In cargo ships with a length (L) of 15 m or above or with a scantling number of 100 or above, but with a gross tonnage below 250, life-saving appliances and other equipment as referred to in subparagraph (c)(i) shall be subjected to the following surveys:*
- (i) *An initial survey before the ship is put into service.*
 - (ii) *A renewal survey at intervals not exceeding 5 years.*
- (c) *The surveys referred to in (a) and (b) shall be carried out as follows:*
- (i) *The initial survey shall include a full inspection of fire safety systems and extinguishing appliances, life-saving appliances and arrangements, with the exception of radio installations, shipborne navigational equipment, means of embarkation for pilots and other equipment covered by chapters II-1, II-2, III and V to ensure that it complies with the requirements of the present regulations, is in satisfactory condition and fit for the service for which the ship is intended. Fire control plans, nautical publications, lights, shapes and means of making sound signals and distress signals shall be subjected to an equivalent survey to that referred to above for the purpose of ensuring that they comply with the requirements of the present regulations and of the International Regulations for Preventing Collisions at Sea in force, where applicable.*
 - (ii) *Renewal and periodical surveys shall comprise an inspection of the equipment referred to in subparagraph (c)(i) for the purpose of ensuring that it complies with the requirements of the present regulations and of the International Regulations for Preventing Collisions at Sea in force, is in satisfactory condition and fit for the service for which the ship is intended.¹⁰⁾*

⁹⁾ Refer to the Record of approved cargo ship safety equipment (SLS.14/Circ.1).

¹⁰⁾ In the case of cargo ships constructed before 1 January 2002, the rules in force at the time of construction, as amended. For ships constructed after 1 June 1985 but before 1 January 2002, Notice C from the Danish Register of Ships, as amended.

(d) The intermediate surveys referred to in paragraph (a)(iii) shall be endorsed on the Cargo Ship Safety Certificate for cargo ships with less than 500 gross tonnage.

Regulation 9 – Surveys of radio installations of cargo ships of 300 gross tonnage and above

- (a) The radio installations, including those used in lifesaving appliances, of cargo ships to which chapters III and IV apply shall be subject to the surveys specified below:
- (i) an initial survey before the ship is put in service;
 - (ii) a renewal survey at intervals specified by the Administration but not exceeding five years, except where regulation 14(b), (e), (f) and (g) is applicable;
 - (iii) a periodical survey within three months before or after each anniversary date of the Cargo Ship Safety Radio Certificate;
 - (iv) an additional survey as prescribed for passenger ships in regulation 7(b)(iii).
- (b) The surveys referred to in paragraph (a) shall be carried out as follows:
- (i) the initial survey shall include a complete inspection of the radio installations of cargo ships, including those used in life-saving appliances, to ensure that they comply with the requirements of the present regulations;
 - (ii) the renewal and periodical surveys shall include an inspection of the radio installations of cargo ships, including those used in life-saving appliances, to ensure that they comply with the requirements of the present regulations.
- (c) The periodical surveys referred to in paragraph (a)(iii) shall be endorsed on the Cargo Ship Safety Radio Certificate.

Regulation 9-1 – Surveys of radio installations of cargo ships of less than 300 gross tonnage

The annual surveys referred to in subparagraph (a)(iii) shall not apply to ships engaged solely on domestic voyages.

- (a) *The radio installations, including those used in life-saving appliances in cargo ships to which chapters III and IV apply, shall be subjected to the following surveys:*
- (i) An initial survey before the ship is put into service.*
 - (ii) A renewal survey at intervals not exceeding 5 years.*
 - (iii) An annual survey within 3 months before or after each anniversary date of the Cargo Ship Safety Certificate.*
- (b) *The surveys referred to in (a) shall be carried out as follows:*
- (i) The initial survey shall include a complete inspection of the cargo ship's radio installations, including those used in life-saving appliances, for the purpose of ensuring that they comply with the requirements of the present regulations;*
 - (ii) The renewal and annual surveys shall include an inspection of the cargo ship's radio installations, including those used in life-saving appliances, for the purpose of ensuring that they comply with the requirements of the present regulations.*
- (c) *The annual surveys referred to in subparagraph (a)(iii) shall be endorsed on the Cargo Ship Safety Certificate for cargo ships with less than 500 gross tonnage.*

Regulation 10 – Surveys of structure, machinery and equipment of cargo ships with a gross tonnage of 500 and upwards

- (a) The structure, machinery and equipment (other than items in respect of which a Cargo Ship Safety Equipment Certificate and a Cargo Ship Safety Radio Certificate are issued) of a cargo ship as referred to in paragraph (b)(i) shall be subject to the surveys and inspections specified below:

- (i) an initial survey including an inspection of the outside of the ship's bottom before the ship is put in service;¹¹⁾
 - (ii) a renewal survey at intervals specified by the Administration but not exceeding 5 years, except where regulation 14(b), (e), (f) and (g) is applicable;
 - (iii) an intermediate survey within three months before or after the second anniversary date or within three months before or after the third anniversary date of the Cargo Ship Safety Construction Certificate, which shall take the place of one of the annual surveys specified in paragraph (a)(iv);
 - (iv) an annual survey within 3 months before or after each anniversary date of the Cargo Ship Safety Construction Certificate;
 - (v) a minimum of two inspections of the outside of the ship's bottom during the five-year period of validity of the Cargo Ship Safety Construction Certificate or the Cargo Ship Safety Certificate, except where regulation 14(e) or 14(f) is applicable. Where regulation 14(e) or 14(f) is applicable, this five-year period may be extended to coincide with the extended period of validity of the certificate. In all cases the interval between any two such inspections shall not exceed 36 months;
 - (vi) an additional survey as prescribed for passenger ships in regulation 7(b)(iii).
- (b) The surveys and inspections referred to in paragraph (a) shall be carried out as follows:
- (i) the initial survey shall include a complete inspection of the structure, machinery and equipment. This survey shall be such as to ensure that the arrangements, materials, scantlings and workmanship of the structure, boilers and other pressure vessels, their appurtenances, main and auxiliary machinery including steering gear and associated control systems, electrical installation and other equipment comply with the requirements of the present regulations, are in satisfactory condition and are fit for the service for which the ship is intended and that the required stability information is provided. In the case of tankers such a survey shall also include an inspection of the pump-rooms, cargo, bunker and ventilation piping systems and associated safety devices;
 - (ii) the renewal survey shall include an inspection of the structure, machinery and equipment as referred to in paragraph (b)(i) to ensure that they comply with the requirements of the present regulations, are in satisfactory condition and are fit for the service for which the ship is intended;
 - (iii) the intermediate survey shall include an inspection of the structure, boilers and other pressure vessels, machinery and equipment, the steering gear and the associated control systems and electrical installations to ensure that they remain satisfactory for the service for which the ship is intended. In the case of tankers, the survey shall also include an inspection of the pump-rooms, cargo, bunker and ventilation piping systems and associated safety devices and the testing of insulation resistance of electrical installations in dangerous zones;
 - (iv) the annual survey shall include a general inspection of the structure, machinery and equipment referred to in paragraph (b)(i), to ensure that they have been maintained in accordance with regulation 11(a) and that they remain satisfactory for the service for which the ship is intended;
 - (v) the inspection of the outside of the ship's bottom and the survey of related items inspected at the same time shall be such as to ensure that they remain satisfactory for the service for which the ship is intended.

¹¹⁾ Refer to the circular concerning inspection of the outside of the ship's bottom (PSLS.2/Circ.5).

- (c) The intermediate and annual surveys and the inspections of the outside of the ship's bottom referred to in paragraphs (a)(iii), (a)(iv) and (a)(v) shall be endorsed on the Cargo Ship Safety Construction Certificate.

Regulation 10-1 – Surveys of structure, machinery and equipment of cargo ships with less than 500 gross tonnage

- (a) *Cargo ships with a length (L) of 15 m or above or with a scantling number of 100 or above, but with a gross tonnage below 500, shall be subjected to the following surveys and inspections with regard to structure, machinery and equipment:*
- (i) *An initial survey, before the ship is put into service, including an inspection of the outside of the ship's bottom.*
 - (ii) *A renewal survey at intervals not exceeding 5 years.*
 - (iii) *A minimum of two inspections of the outside of the ship's outside bottom during a 5 year period, with the exception of those cases where regulation 14-1(d) is applicable. Where regulation 14-1(d) is applicable, the 5-year period may be extended to coincide with the extended period of validity of the certificate. In no case may the interval between two such inspections exceed 36 months.*
- (b) *The surveys and inspections referred to in subparagraph (a) shall be carried out as follows:*
- (i) *The initial survey shall include a complete inspection of the ship's structure, machinery and equipment, including the outside of the ship's bottom. This survey shall be such as to ensure that the arrangements, material, scantlings and workmanship of the structure, boilers and other pressure vessels and their appurtenances, main and auxiliary machinery, including steering gear and associated control systems, electrical installations and other equipment comply with the requirements of the present regulations, are in satisfactory condition and fit for the service for which the ship is intended, and that the necessary stability information is provided. Where tankers are concerned, a survey shall also include an inspection of the pump-rooms, cargo and bunker-piping systems, vent piping and associated safety devices.*
 - (ii) *Renewal surveys shall include inspection of structure, including the outside of the ship's bottom, machinery and equipment as stated in subparagraph (b)(i) for the purpose of ensuring that they comply with the requirements of the present regulations, are in satisfactory condition and fit for the service for which the ship is intended.¹²⁾*
 - (iii) *Inspection of the outside of the ship's bottom and the survey of the associated items that are inspected at the same time shall be carried out so as to ensure that they remain adequate for the service for which the ship is intended. The survey shall also include an inspection of the rudder, propeller shafting and all sea connections under the deepest operating waterline.*
- (c) *The said inspection of the outside of the ship's bottom shall be endorsed on the ship's safety certificate.*

Regulation 11 – Maintenance of conditions after survey

- (a) The condition of the ship and its equipment shall be maintained to conform with the provisions of the present regulations to ensure that the ship in all respects will remain fit to proceed to sea without danger to the ship or persons on board.

¹²⁾ *In the case of cargo ships constructed before 1 January 2002, the rules in force at the time of construction, as amended. For ships constructed after 1 June 1985 but before 1 January 2002, Notice C from the Danish Register of Ships, as amended.*

- (b) After any survey of the ship under regulations 7, 8, 9 or 10 has been completed, no change shall be made in the structural arrangements, machinery, equipment and other items covered by the survey, without the sanction of the Administration.
- (c) Whenever an accident occurs to a ship or a defect is discovered, either of which affects the safety of the ship or the efficiency or completeness of its life-saving appliances or other equipment, the master or owner of the ship shall report at the earliest opportunity to the Administration, the nominated surveyor or recognized organization responsible for issuing the relevant certificate, who shall cause investigations to be initiated to determine whether a survey, as required by regulations 7, 8, 9 or 10, is necessary. If the ship is in a port of another Contracting Government, the master or owner shall also report immediately to the appropriate authorities of the port State and the nominated surveyor or recognized organization shall ascertain that such a report has been made.

Regulation 12 – Issue or endorsement of certificates¹³⁾

Except for subparagraph (a)(iv), which applies to cargo ships with a gross tonnage of 300 and above, this regulation shall not apply to cargo ships with a gross tonnage of less than 500.

- (a)
 - (i) A certificate called a Passenger Ship Safety Certificate shall be issued after an initial or renewal survey to a passenger ship which complies with the relevant requirements of chapters II-1, II-2, III, IV and V and any other relevant requirements of the present regulations;

After the said survey on a passenger ship, a further permit to carry passengers shall be issued. The permit shall contain information about the conditions of the ship's operation, including as a minimum the ship's area of operation and the maximum permitted number of passengers. The permit shall be issued in duplicate, one copy of which shall be placed in a location on board where passengers can easily see it. The other copy shall be kept with the ship's annexed file.

- (ii) a certificate called a Cargo Ship Safety Construction Certificate¹⁴⁾ shall be issued after an initial or renewal survey to a cargo ship which complies with the relevant requirements of chapters II-1 and II-2 (other than those relating to fire safety systems and appliances and fire control plans) and any other relevant requirements of the present regulations;

After an initial survey of a cargo ship, a further permit shall be issued for the ship to enter into service. The trading permit shall state the area in which the ship may operate and the terms on which the ship may be used. Furthermore, the maximum number of persons that the ship may carry with the life-saving appliances on board shall be stated.

- (iii) a certificate called a Cargo Ship Safety Equipment Certificate shall be issued after an initial or renewal survey to a cargo ship which complies with the relevant requirements of chapters II-1, II-2, III and V and any other relevant requirements of the present regulations;

¹³⁾ Refer to resolution A.791(19) on application of the International Convention on Tonnage Measurement of Ships, 1969, to existing ships

¹⁴⁾ Refer to the circular concerning issue of supplements and attachments (PSLS.2/Circ.1).

- (iv) a certificate called a Cargo Ship Safety Radio Certificate shall be issued after an initial or renewal survey to a cargo ship which complies with the relevant requirements of chapter IV and any other relevant requirements of the present regulations;
 - (v)
 - (1) a certificate called a Cargo Ship Safety Certificate may be issued after an initial or renewal survey to a cargo ship which complies with the relevant requirements of chapters II-1, II-2, III, IV and V and any other relevant requirements of the present regulations, as an alternative to the certificates referred to in paragraph (a)(ii), (a)(iii) and (a)(iv);
 - (2) whenever in this chapter reference is made to a Cargo Ship Safety Construction Certificate, Cargo Ship Safety Equipment Certificate or Cargo Ship Safety Radio Certificate, it shall apply to a Cargo Ship Safety Certificate, if it is used as an alternative to these certificates.
 - (vi) the Passenger Ship Safety Certificate, the Cargo Ship Safety Equipment Certificate, the Cargo Ship Safety Radio Certificate and the Cargo Ship Safety Certificate, referred to in subparagraphs (i), (iii), (iv) and (v), shall be supplemented by a Record of Equipment;
 - (vii) when an exemption is granted to a ship under and in accordance with the provisions of the present regulations, a certificate called an Exemption Certificate shall be issued in addition to the certificates prescribed in this paragraph;
 - (viii) the certificates referred to in this regulation shall be issued or endorsed either by the Administration or by any person or organization authorized by it. In every case, that Administration assumes full responsibility for the certificates.
- (b) A Contracting Government shall not issue certificates under, and in accordance with, the provisions of the International Convention for the Safety of Life at Sea, 1960, 1948 or 1929, after the date on which acceptance of the present Convention by the Government takes effect.

Regulation 12-1 – Issue of certificates for cargo ships with a gross tonnage of less than 500

- (i) *After an initial survey of a cargo ship, a permit shall be issued for the ship to enter into service. The trading permit shall state the area in which the ship may operate and the terms on which the ship may be used. Furthermore, the maximum number of persons that the ship may carry with the life-saving appliances on board shall be stated.*
- (ii) *A national certificate called a National Cargo Ship Safety Certificate shall be issued after an initial survey or renewal survey to a cargo ship which complies with the requirements of chapters II-1, II-2, III, IV and V and any other relevant requirements of the present regulations. For existing cargo ships constructed before 1 January 2002 that comply with the regulations¹⁵⁾ and requirements pertaining to the ship in force, a Cargo Ship Safety Certificate shall be issued after a renewal survey. On cargo ships with a gross tonnage of 300 and above, the relevant requirements for radio installations shall be covered by the Cargo Ship Safety Radio Certificate referred to in regulation 12 (iv). On cargo ships classified by a classification society, the relevant requirements for hull structure, strength, anchor equipment, machinery, boiler plants, equipment and installations to be designated periodically unattended engine space and electrical installations shall be covered by the classification certificates for hull and machinery. The Cargo Ship Safety Certificate shall be supplemented by a Record of Equipment for the Cargo Ship Safety Certificate.*

¹⁵⁾ *In the case of cargo ships constructed before 1 January 2002, the rules in force at the time of construction, as amended. For ships constructed after 1 June 1985 but before 1 January 2002, Notice C from the Danish Register of Ships, as amended.*

- (iii) *If a ship has been granted an exemption in accordance with these regulations, this shall be noted on the Cargo Ship Safety Certificate and in the annexed file required under regulation 22.*
- (iv) *Certificates referred to in this regulation are issued or endorsed by the Administration or by any person or organisation duly authorised by it.*

Regulation 13 – Issue or endorsement of certificates by another Government

This regulation shall not apply to certificates issued in accordance with regulation 12-1.

A Contracting Government may, at the request of the Administration, cause a ship to be surveyed and, if satisfied that the requirements of the present regulations are complied with, shall issue or authorize the issue of certificates to the ship and, where appropriate, endorse or authorize the endorsement of certificates on the ship in accordance with the present regulations. Any certificate so issued shall contain a statement to the effect that it has been issued at the request of the Government of the State the flag of which the ship is entitled to fly, and it shall have the same force and receive the same recognition as a certificate issued under regulation 12.

Regulation 14 – Duration and validity of certificates

This regulation shall not apply to certificates issued in accordance with regulation 12-1.

- (a) A Passenger Ship Safety Certificate shall be issued for a period not exceeding 12 months. A Cargo Ship Safety Construction Certificate, Cargo Ship Safety Equipment Certificate and Cargo Ship Safety Radio Certificate shall be issued for a period specified by the Administration which shall not exceed five years. An Exemption Certificate shall not be valid for longer than the period of the certificate to which it refers.

A permit to carry passengers shall be valid for as long as the conditions for the use of the ship remain unchanged and are complied with. Furthermore, the validity shall be dependent upon compliance with the survey intervals stipulated in the Passenger Ship Safety Certificate.

A trading permit shall be valid for as long as the conditions for the use of the ship remain unchanged and are complied with. Furthermore, the validity shall be dependent upon compliance with the survey intervals stipulated in the Cargo Ship Safety Certificate.

- (b)
 - (i) notwithstanding the requirements of paragraph (a), when the renewal survey is completed within three months before the expiry date of the existing certificate, the new certificate shall be valid from the date of completion of the renewal survey to:
 - (1) for a passenger ship, a date not exceeding 12 months from the date of expiry of the existing certificate;
 - (2) for a cargo ship, a date not exceeding five years from the date of expiry of the existing certificate;
 - (ii) when the renewal survey is completed after the expiry date of the existing certificate, the new certificate shall be valid from the date of completion of the renewal survey to:
 - 1) for a passenger ship, a date not exceeding 12 months from the date of expiry of the existing certificate;
 - 2) for a cargo ship, a date not exceeding five years from the date of completion of the renewal survey.

- (c) If a certificate other than a Passenger Ship Safety Certificate is issued for a period of less than five years, the Administration may extend the validity of the certificate beyond the expiry date to the maximum period specified in paragraph (a), provided that the surveys referred to in regulations 8, 9 and 10 applicable when a certificate is issued for a period of 5 years are carried out as appropriate.
- (d) If a renewal survey has been completed and a new certificate cannot be issued or placed on board the ship before the expiry date of the existing certificate, the person or organization authorized by the Administration may endorse the existing certificate and such a certificate shall be accepted as valid for a further period which shall not exceed 5 months from the expiry date.
- (e) If a ship at the time when a certificate expires is not in a port in which it is to be surveyed, the Administration may extend the period of validity of the certificate but this extension shall be granted only for the purpose of allowing the ship to complete its voyage to the port in which it is to be surveyed, and then only in cases where it appears proper and reasonable to do so. No certificate shall be extended for a period longer than three months, and a ship to which an extension is granted shall not, on its arrival in the port in which it is to be surveyed, be entitled by virtue of such extension to leave that port without having a new certificate. When the renewal survey is completed, the new certificate shall be valid to:
 - (i) for a passenger ship, a date not exceeding 12 months from the date of expiry of the existing certificate before the extension was granted;
 - (ii) for a cargo ship, a date not exceeding 5 years from the date of expiry of the existing certificate before the extension was granted.
- (f) A certificate issued to a ship engaged on short voyages which has not been extended under the foregoing provisions of this regulation may be extended by the Administration for a period of grace of up to one month from the date of expiry stated on it. When the renewal survey is completed, the new certificate shall be valid to:
 - (i) for a passenger ship, a date not exceeding 12 months from the date of expiry of the existing certificate before the extension was granted;
 - (ii) for a cargo ship, a date not exceeding 5 years from the date of expiry of the existing certificate before the extension was granted.
- (g) In special circumstances, as determined by the Administration, a new certificate need not be dated from the date of expiry of the existing certificate as required by paragraphs (b)(ii), (e) or (f). In these special circumstances, the new certificate shall be valid to:
 - (i) for a passenger ship, a date not exceeding 12 months from the date of completion of the renewal survey;
 - (ii) for a cargo ship, a date not exceeding five years from the date of completion of the renewal survey.
- (h) If an annual, intermediate or periodical survey is completed before the period specified in the relevant regulations then:
 - (i) the anniversary date shown on the relevant certificate shall be amended by endorsement to a date which shall not be more than three months later than the date on which the survey was completed;
 - (ii) the subsequent annual, intermediate or periodical survey required by the relevant regulations shall be completed at the intervals prescribed by these regulations using the new anniversary date;
 - (iii) the expiry date may remain unchanged provided one or more annual, intermediate or periodical surveys, as appropriate, are carried out so that the maximum intervals between the surveys prescribed by the relevant regulations are not exceeded.

- (i) A certificate issued under regulation 12 or 13 shall cease to be valid in any of the following cases:
 - (i) if the relevant surveys and inspections are not completed within the periods specified under regulations 7(a), 8(a), 9 (a) and 10(a);
 - (ii) if the certificate is not endorsed in accordance with the present regulations;
 - (iii) upon transfer of the ship to the flag of another State. A new certificate shall only be issued when the Government issuing the new certificate is fully satisfied that the ship is in compliance with the requirements of regulation 11(a) and (b). In the case of a transfer between Contracting Governments, if requested within three months after the transfer has taken place, the Government of the State whose flag the ship was formerly entitled to fly shall, as soon as possible, transmit to the Administration copies of the certificates carried by the ship before a transfer and, if available, copies of the relevant survey reports.

Regulation 14-1 – Duration and validity of certificates in cargo ships with a gross tonnage of less than 500

This regulation shall apply to certificates issued in accordance with regulation 12-1 only.

- (a) *A trading permit shall be valid for as long as the conditions for the use of the ship remain unchanged and are complied with. Furthermore, the validity shall be dependent upon compliance with the survey intervals stipulated in the National Cargo Ship Safety Certificate.*
- (b) *A National Cargo Ship Safety Certificate shall be issued for a period not exceeding 5 years.*
- (c)
 - (i) *When a renewal survey has been carried out within 3 months before the expiry date of the existing certificate, the new certificate shall be valid from the day on which the renewal survey was completed and for not more than 5 years from the expiry date of the existing certificate.*
 - (ii) *When a renewal survey has been carried out after the expiry date of the existing certificate, the new certificate shall be valid from the day on which the renewal survey was completed and for not more than 5 years from the expiry date of the existing certificate.*
 - (iii) *When a renewal survey is carried out more than 3 months before the expiry date of the existing certificate, the new certificate shall be valid for not more than 5 years from the day on which the renewal survey was completed.*
- (d) *The Danish Maritime Authority may extend the validity of the certificate beyond the date of expiry in accordance with the provisions of regulation 14(c) to (h).*
- (e) *A certificate issued pursuant to regulation 12-1 shall cease to be valid in any of the following cases:*
 - (i) *if the relevant surveys and inspections are not carried out within the periods specified under regulations 8-1(a) and (b), 9-1(a), and 10-1(a);*
 - (ii) *upon transfer of the ship to the flag of another State.*

Regulation 15 – Forms of certificates and records of equipment

This regulation shall not apply to certificates issued in accordance with regulation 12-1.

The certificates and records of equipment shall be drawn up in the form corresponding to the models given in the appendix¹⁶⁾ to the present Convention (SOLAS 74). If the language used is neither English nor French, the text shall include a translation into one of these languages.¹⁷⁾

¹⁶⁾ Refer to appendix 1.

Regulation 15-1 – Form of certificates and records of equipment for cargo ships with a gross tonnage of less than 500

This regulation shall apply to certificates issued in accordance with regulation 12-1.

The certificates and the records of equipment shall be drawn up in a form corresponding to the models given in Appendix 2. The certificates shall be drawn up in English and may be provided with a Danish subtext.

Regulation 16 – Availability of certificates

The certificates issued under regulations 12 and 13 *and regulation 12-1* shall be readily available on board for examination at all times.

Regulation 17 – Acceptance of certificates

This regulation shall not apply to certificates issued in accordance with regulation 12-1.

Certificates issued under the authority of a Contracting Government shall be accepted by the other Contracting Governments for all purposes covered by the present Convention (*SOLAS 74*). They shall be regarded by the other Contracting Governments as having the same force as certificates issued by them.

Regulation 18 – Qualification of certificates

- (a) If in the course of a particular voyage a ship has on board a number of persons less than the total number stated in the Passenger Ship Safety Certificate and is in consequence, in accordance with the provisions of the present regulations, free to carry a smaller number of lifeboats and other life-saving appliances than that stated in the certificate, an annex may be issued by the Government, person or organization referred to in regulation 12 or 13 of this chapter.
- (b) This annex shall state that in the circumstances there is no infringement of the provisions of the present regulations. It shall be annexed to the certificate and shall be substituted for it in so far as the life-saving appliances are concerned. It shall be valid only for the particular voyage for which it is issued.

Regulation 19 – Control¹⁸⁾

- (a) Every ship when in a port of another Contracting Government is subject to control by officers duly authorized by such Government in so far as this control is directed towards verifying that the certificates issued under regulation 12 or regulation 13 are valid.
- (b) Such certificates, if valid, shall be accepted unless there are clear grounds for believing that the condition of the ship or of its equipment does not correspond substantially with the particulars of any of the certificates or that the ship and its equipment are not in compliance with the provisions of regulations 11(a) and (b).
- (c) In the circumstances given in paragraph (b) or where a certificate has expired or ceased to be valid, the officer carrying out the control shall take steps to ensure that the ship shall not sail until it can proceed to sea or leave the port for the purpose of proceeding to the appropriate repair yard without danger to the ship or persons on board.

¹⁷⁾ Refer to resolution A.561(14) on translation of the text of certificates.

¹⁸⁾ Refer to the Procedures for port State control adopted by the Organization by resolution A.787(19), as amended by resolution A.882(21).

- (d) In the event of this control giving rise to an intervention of any kind, the officer carrying out the control shall forthwith inform, in writing, the Consul or, in his absence, the nearest diplomatic representative of the State whose flag the ship is entitled to fly of all the circumstances in which intervention was deemed necessary. In addition, nominated surveyors or recognized organizations responsible for the issue of the certificates shall also be notified. The facts concerning the intervention shall be reported to the Organization.
- (e) The port State authority concerned shall notify all relevant information about the ship to the authorities of the next port of call, in addition to parties mentioned in paragraph (d), if it is unable to take action as specified in paragraphs (c) and (d) or if the ship has been allowed to proceed to the next port of call.
- (f) When exercising control under this regulation all possible efforts shall be made to avoid a ship being unduly detained or delayed. If a ship is thereby unduly detained or delayed it shall be entitled to compensation for any loss or damage suffered.

Regulation 20 – Privileges

The privileges of the present Convention (*SOLAS 74*) may not be claimed in favour of any ship unless it holds appropriate valid certificates.

Part C – Casualties

Regulation 21 – Casualties

- (a) Each Administration undertakes to conduct an investigation of any casualty occurring to any of its ships subject to the provisions of the present Convention (*SOLAS 74*) when it judges that such an investigation may assist in determining what changes in the present regulations might be desirable¹⁹⁾.
- (b) Each Contracting Government undertakes to supply the Organization with pertinent information concerning the findings of such investigations. No reports or recommendations of the Organization based upon such information shall disclose the identity or nationality of the ships concerned or in any manner fix or imply responsibility upon any ship or person.

Part D – Miscellaneous items

Regulation 22 – Annexed file

*Any ship covered by these regulations shall be provided with an annexed file. A full annexed file shall be kept on board until it is attested by the Danish Maritime Authority in the new annexed file that all necessary information has been transferred from the full annexed file.*²⁰⁾

¹⁹⁾ Refer to the following resolution adopted by the Organization:

Resolution A.849(20): Code for the investigation of marine casualties and incidents, as amended by resolution A.884.(21),

Refer also to:

MSC/Circ.953 – MEPC/Circ.372: Reports on marine casualties and incidents. Revised harmonizing reporting procedures – Reports required under SOLAS regulation I/21 and MARPOL 73/78 articles 8 and 12, *and to Order no. 790 of 1 July 2006 on the investigation of marine casualties. Furthermore, reference is made to resolution MSC.255(84), “Adoption of the code of the international standards and recommended practices for a safety investigation into a marine casualty or marine incident (Casualty Investigation Code)”*.

²⁰⁾ *Where digital recording of inspections, tests and drills is used and where the requirement to record such information in the annexed file in such cases may lead to double recordings, the Danish Maritime Authority will accept a print of the mentioned recordings provided that such prints are kept in the annexed file.*

Regulation 23 – General safety

Adequate measures shall be taken to safeguard against accidents during normal operation of the ship so that while working or residing on board or while embarking or disembarking, as far as possible, no one is put at risk of coming to harm, except as a result of a lack of due care and attention.

**Notice from the Danish Maritime Authority B –
The Construction and Equipment, etc. of Ships**

Chapter B II-1 A

Construction – Structure, subdivision and stability, machinery and electrical installations

Regulation 1 – Application	1
Regulation 2 – Definitions	2
Regulation 3 – Definitions relating to parts C, D and E	4
Regulation 3-1 – Structural, mechanical and electrical requirements for ships.....	6
Regulation 3-2 – Protective coatings of dedicated seawater ballast tanks in all types of ships and double-side skin spaces of bulk carriers	6
Regulation 3-3 – Safe access to tanker bows.....	7
Regulation 3-4 – Emergency towing arrangements on tankers	7
Regulation 3-5 – New installation <i>and repairs</i> of materials containing asbestos.....	8
Regulation 3-6 – Access to and within spaces in the cargo area of oil tankers and bulk carriers	8
Regulation 3-7 Construction drawings maintained on board and ashore	10
Regulation 3-8 – Towing and mooring equipment	10
Regulation 3-9 – Means of embarkation on and disembarkation from ships.....	10
<i>Regulation 3-10 – Guidelines for the construction and installation of suspended decks with associated safety devices in passenger ships</i>	<i>11</i>

Part A – General

Regulation 1 – Application

- 1.1 Unless expressly provided otherwise, this chapter shall apply to *passenger ships, regardless of size, and cargo ships with a gross tonnage of 500 or more, the keels of which are laid or which are at a similar stage of construction on or after 1 January 2009 as well as to cargo ships with a gross tonnage below 500 the keels of which are laid on or after 1 January 2002.*
- 1.2 For the purpose of this chapter, the term “a similar stage of construction” means the stage at which:
 - .1 construction identifiable with a specific ship begins; and
 - .2 assembly of that ship has commenced comprising at least 50 tonnes or one per cent of the estimated mass of all structural material, whichever is less.
- 1.3 For the purpose of this chapter:
 - 1.3.1 the expression “ships constructed” means ships the keels of which are laid or which are at a similar stage of construction;

- 1.3.2 the expression “all ships” means *passenger ships, regardless of size, and cargo ships with a gross tonnage of 500 or more constructed before, on or after 1 January 2009 as well as cargo ships with a gross tonnage below 500 constructed on or after 1 January 2002*;
 - 1.3.3 a cargo ship, whenever built, which is converted to a passenger ship shall be treated as a passenger ship constructed on the date on which such a conversion commences.
 - 1.3.4 the expression “alterations and modifications of major character” means, in the context of cargo ship subdivision and stability, any modification to the construction which affects the level of subdivision of that ship. Where a cargo ship is subject to such modification, it shall be demonstrated that the A/R ratio calculated for the ship after such modification is not less than the A/R before the modification. However, in these cases where the ship’s A/R ratio before modification is equal to or greater than unity, it is only necessary that the ship after modification has an A value which is not less than R, calculated for the modified ship.
2. Unless expressly provided otherwise, for *passenger ships, regardless of size, and cargo ships with a gross tonnage of 500 or more* constructed before 1 January 2009, the Administration shall ensure that the requirements which are applicable under chapter II-1 of the International Convention for the Safety of Life at Sea, 1974, as amended by resolutions MSC.1(XLV), MSC.6(48), MSC.11(55), MSC.12(56), MSC.13(57), MSC.19(58), MSC.26(60), MSC.27(61), Resolution 1 of the 1995 SOLAS Conference, MSC.47(66), MSC.57(67), MSC.65(68), MSC.69(69), MSC.99(73), MSC.134(76), MSC.151(78) and MSC.170(79) are complied with.
 3. All ships which undergo repairs, alterations, modifications and outfitting related thereto shall continue to comply with at least the requirements previously applicable to these ships. Such ships, if constructed before 1 January 2009, shall, as a rule, comply with the requirements for ships constructed on or after that date to at least the same extent as they did before undergoing such repairs, alterations, modifications or outfitting. Repairs, alterations and modifications of a major character and outfitting related thereto shall meet the requirements for ships constructed on or after 1 January 2009 in so far as the Administration deems reasonable and practicable.
 4. The Administration of a State may, if it considers that the sheltered nature and conditions of the voyage are such as to render the application of any specific requirements of this chapter unreasonable or unnecessary, exempt from those requirements individual ships or classes of ships entitled to fly the flag of that State which, in the course of their voyage, do not proceed more than 20 miles from the nearest land.
 5. In the case of passenger ships which are employed in special trades for the carriage of large numbers of special trade passengers, such as the pilgrim trade, the Administration of the State whose flag such ships are entitled to fly, if satisfied that it is impracticable to enforce compliance with the requirements of this chapter, may exempt such ships from those requirements, provided that they comply fully with the provisions of:
 - 5.1. the rules annexed to the Special Trade Passenger Ships Agreement, 1971; and
 - 5.2. the rules annexed to the Protocol on Space Requirements for Special Trade Passenger Ships, 1973.

Regulation 2 – Definitions

For the purpose of this chapter, unless expressly provided otherwise:

1. *Subdivision length (L_s)* of the ship is the greatest projected moulded length of that part of the ship at or below deck or decks limiting the vertical extent of flooding with the ship at the deepest subdivision draught.
2. *Mid-length* is the mid-point of the subdivision length of the ship
3. *Aft terminal* is the aft limit of the subdivision length.
4. *Forward terminal* is the forward limit of the subdivision length.
5. *Length (L)* is the length as defined in the International Convention on Load Lines in force.
6. *Freeboard deck* is the deck as defined in the International Convention on Load Lines in force.
7. *Forward perpendicular* is the forward perpendicular as defined in the International Convention on Load Lines in force.
8. *Breadth (B)* is the greatest moulded breadth of the ship at or below the deepest subdivision draught.
9. *Draught (d)* is the vertical distance from the keel-line at mid-length to the waterline in question.
10. *Deepest subdivision draught (d_s)* is the waterline which corresponds to the summer load line of the ship.
11. *Light service draught (d_l)* is the service draught corresponding to the lightest anticipated loading and associated tankage, including, however, such ballast as may be necessary for stability and/or immersion. Passenger ships should include the full complement of passengers and crew on board.
12. *Partial subdivision draught (d_p)* is the light service draught plus 60% of the difference between the light service draught and the deepest subdivision draught.
13. *Trim* is the difference between the draught forward and the draught aft, where the draughts are measured at the forward and aft terminals respectively, disregarding any rake of keel.
14. *Permeability (μ)* of a space is the proportion of the immersed volume of that space which can be occupied by water.
15. *Machinery spaces* are spaces between the watertight boundaries of a space containing the main and auxiliary propulsion machinery, including boilers, generators and electric motors primarily intended for propulsion. In the case of unusual arrangements, the Administration may define the limits of the machinery spaces.
16. *Weathertight* means that in any sea conditions water will not penetrate into the ship.
17. *Watertight* means having scantlings and arrangements capable of preventing the passage of water in any direction under the head of water likely to occur in intact and damaged conditions. In the damaged condition, the head of water is to be considered in the worst situation at equilibrium, including intermediate stages of flooding.
18. *Design pressure* means the hydrostatic pressure for which each structure or appliance assumed watertight in the intact and damage stability calculations is designed to withstand.
19. *Bulkhead deck* in a passenger ship means the uppermost deck at any point in the subdivision length (L_s) to which the main bulkheads and the ship's shell are carried watertight and the lowermost deck from which passenger and crew evacuation will not be impeded by water in any stage of flooding for damage cases defined in regulation 8 and in part B-2 of this chapter. The bulkhead deck may be a stepped deck. In a cargo ship the freeboard deck may be taken as the bulkhead deck.
20. *Deadweight* is the difference in tonnes between the displacement of a ship in water of a specific gravity of 1.025 at the draught corresponding to the assigned summer freeboard and the lightweight of the ship.

21. *Lightweight* is the displacement of a ship in tonnes without cargo, fuel, lubricating oil, ballast water, fresh water and feedwater in tanks, consumable stores, and passengers and crew and their effects.
22. *Oil tanker* is the oil tanker defined in regulation 1 of Annex I of the Protocol of 1978 relating to the International Convention for the Prevention of Pollution from ships, 1973.
23. *Ro-ro passenger ship* means a passenger ship with ro-ro spaces or special category spaces as defined in regulation II-2/3.
24. *Bulk carrier* means a bulk carrier as defined in regulation XII/1.1.
25. *Keel line* is a line parallel to the slope of the keel passing amidships through:
 - 25.1. the top of the keel at centreline or line of intersection of the inside of shell plating with the keel if a bar keel extends below that line, on a ship with a metal shell; or
 - 25.2. in wood and composite ships, the distance is measured from the lower edge of the keel rabbet. When the form at the lower part of the midship section is of a hollow character, or where thick garboards are fitted, the distance is measured from the point where the line of the flat of the bottom continued inward intersects the centreline amidships.
26. *Amidship* is at the middle of the length (L).
27. *2008 IS Code* means the International Code on Intact Stability, 2008, consisting of an introduction, part A (the provisions of which shall be treated as mandatory) and part B (the provisions of which shall be treated as recommendatory).

Regulation 3 – Definitions relating to parts C, D and E

For the purpose of parts C, D and E, unless expressly provided otherwise:

1. “Steering gear control system” is the equipment by which orders are transmitted from the navigation bridge to the steering gear power units. Steering gear control systems comprise transmitters, receivers, hydraulic control pumps and their associated motors, motor controllers, piping and cables.
2. “Main steering gear” is the machinery, rudder actuators, steering gear power units, if any, and ancillary equipment and the means of applying torque to the rudder stock (e.g. tiller or quadrant) necessary for effecting movement of the rudder for the purpose of steering the ship under normal service conditions.
3. “Steering gear power unit” is:
 - 3.1. in the case of electric steering gear, an electric motor and its associated electrical equipment;
 - 3.2. in the case of electrohydraulic steering gear, an electric motor and its associated electrical equipment and connected pump;
 - 3.3. in the case of other hydraulic steering gear, a driving engine and connected pump.
4. “Auxiliary steering gear” is the equipment other than any part of the main steering gear necessary to steer the ship in the event of failure of the main steering gear but not including the tiller, quadrant or components serving the same purpose.
5. “Normal operational and habitable condition” is a condition under which the ship as a whole, the machinery, services, means and aids ensuring propulsion, ability to steer, safe navigation, fire and flooding safety, internal and external communications and signals, means of escape, and emergency boat winches, as well as the designed comfortable conditions of habitability are in working order and functioning normally.

6. "Emergency condition" is a condition under which any services needed for normal operational and habitable conditions are not in working order due to failure of the main source of electrical power.
7. "Main source of electrical power" is a source intended to supply electrical power to the main switchboard for distribution to all services necessary for maintaining the ship in normal operational and habitable condition.
8. "Dead ship condition" is the condition under which the main propulsion plant, boilers and auxiliaries are not in operation due to the absence of power.
9. "Main generating station" is the space in which the main source of electrical power is situated.
10. "Main switchboard" is a switchboard which is directly supplied by the main source of electrical power and is intended to distribute electrical energy to the ship's services.
11. "Emergency switchboard" is a switchboard which in the event of failure of the main electrical power supply system is directly supplied by the emergency source of electrical power or the transitional source of emergency power and is intended to distribute electrical energy to the emergency services.
12. "Emergency source of electrical power" is a source of electrical power, intended to supply the emergency switchboard in the event of failure of the supply from the main source of electrical power.
13. "Power actuating system" is the hydraulic equipment provided for supplying power to turn the rudder stock, comprising a steering gear power unit or units, together with the associated pipes and fittings, and a rudder actuator. The power actuating systems may share common mechanical components, i.e., tiller, quadrant and rudder stock, or components serving the same purpose.
14. "Maximum ahead service speed" is the greatest speed which the ship is designed to maintain in service at sea at the deepest seagoing draught.
15. "Maximum astern speed" is the speed which it is estimated the ship can attain at the designed maximum astern power at the deepest seagoing draught.
16. "Machinery spaces" are all machinery spaces of category A and all other spaces containing propelling machinery, boilers, oil fuel units, steam and internal combustion engines, generators and major electrical machinery, oil filling stations, refrigerating, stabilizing, ventilation and air conditioning machinery, and similar spaces, and trunks to such spaces.
17. "Machinery spaces of category A" are those spaces and trunks to such spaces which contain:
 - 17.1. internal combustion machinery used for main propulsion; or
 - 17.2. internal combustion machinery used for purposes other than main propulsion where such machinery has in the aggregate a total power output of not less than 375 kW; or
 - 17.3. any oil-fired boiler or oil fuel unit.
18. "Control stations" are those spaces in which the ship's radio or main navigating equipment or the emergency source of power is located or where the fire recording or fire control equipment is centralized.
19. "Chemical tanker" is a cargo ship constructed or adapted and used for the carriage in bulk of any liquid product listed in either:
 - 19.1. chapter 17 of the International Code for the Construction and Equipment of Ships Carrying Dangerous Chemicals in Bulk adopted by the Maritime Safety Committee by resolution MSC.4(48), hereinafter referred to as "the International Bulk Chemical Code", as may be amended by the Organization; or

- 19.2. chapter VI of the Code for the Construction and Equipment of Ships Carrying Dangerous Chemicals in Bulk adopted by the Assembly of the Organization by resolution A.212(VII), hereinafter referred to as "the Bulk Chemical Code", as has been or may be amended by the Organization; whichever is applicable.
20. "Gas carrier" is a cargo ship constructed or adapted and used for the carriage in bulk of any liquefied gas or other products listed in either:
 - 20.1. chapter 19 of the International Code for the Construction and Equipment of Ships Carrying Liquefied Gases in Bulk adopted by the Maritime Safety Committee by resolution MSC.5(48) hereinafter referred to as "the International Gas Carrier Code", as may be amended by the Organization; or
 - 20.2. chapter XIX of the Code for the Construction and Equipment of Ships Carrying Liquefied Gases in Bulk adopted by the Organization by resolution A.328(IX), hereinafter referred to as "the Gas Carrier Code", as has been or may be amended by the Organization; whichever is applicable.

A-1 – Structure of ships

Regulation 3-1 – Structural, mechanical and electrical requirements for ships

In addition to the requirements contained elsewhere in the present regulations, ships shall be designed, constructed and maintained in compliance with the structural, mechanical and electrical requirements of a classification society which is recognized by the Administration in accordance with the provisions of regulation XI-1/1, or with applicable national standards of the Administration which provide an equivalent level of safety.

Regulation 3-2 – Protective coatings of dedicated seawater ballast tanks in all types of ships and double-side skin spaces of bulk carriers

1. Paragraphs 2 and 4 of this regulation shall apply to ships of not less than 500 gross tonnage:
 - 1.1. for which the building contract is placed on or after 1 July 2008; or
 - 1.2. in the absence of a building contract, the keels of which are laid or which are at a similar stage of construction on or after 1 January 2009; or
 - 1.3. the delivery of which is on or after 1 July 2012.
2. All dedicated seawater ballast tanks arranged in ships and double-side skin spaces arranged in bulk carriers of 150 m length and upwards shall be coated during construction in accordance with the Performance standard for protective coatings for dedicated seawater ballast tanks in all types of ships and double-side skin spaces of bulk carriers, adopted by the Maritime Safety Committee by resolution MSC.215(82), as may be amended by the Organization, provided that such amendments are adopted, brought into force and take effect in accordance with the provisions of article VIII of the present Convention concerning the amendment procedures applicable to the Annex other than chapter I.
3. All dedicated seawater ballast tanks arranged in oil tankers and bulk carriers constructed on or after 1 July 1998, for which paragraph 2 is not applicable, shall comply with the requirements of regulation II-1/3-2 adopted by resolution MSC.47(66).
4. Maintenance of the protective coating system shall be included in the overall ship's maintenance scheme. The effectiveness of the protective coating system shall be verified during the life of a

ship by the Administration or an organization recognized by the Administration, based on the guidelines developed by the Organization¹.

Regulation 3-3 – Safe access to tanker bows

This regulation shall apply to tankers with a gross tonnage of or above 500.

1. For the purpose of this regulation and regulation 3-4, tankers include oil tankers as defined in regulation 2, chemical tankers as defined in regulation VII/8.2 and gas carriers as defined in regulation VII/11.2.
2. Every tanker shall be provided with the means to enable the crew to gain safe access to the bow even in severe weather conditions. Such means of access shall be approved by the Administration based on the guidelines developed by the Organization.²

Regulation 3-4 – Emergency towing arrangements on tankers

1. Emergency towing arrangements on tankers

- 1.1. Emergency towing arrangements shall be fitted at both ends on board every tanker of not less than 20,000 tonnes deadweight.
- 1.2. For tankers constructed on or after 1 July 2002:
 - 1.2.1. the arrangements shall, at all times, be capable of rapid deployment in the absence of main power on the ship to be towed and easy connection to the towing ship. At least one of the emergency towing arrangements shall be pre-rigged ready for rapid deployment; and
 - 1.2.2. emergency towing arrangements at both ends shall be of adequate strength taking into account the size and deadweight of the ship, and the expected forces during bad weather conditions. The design and construction and prototype testing of emergency towing arrangements shall be approved by the Administration, based on the Guidelines developed by the Organization.³
- 1.3. For tankers constructed before 1 July 2002, the design and construction of emergency towing arrangements shall be approved by the Administration, based on the Guidelines developed by the Organization.⁴

2. Emergency towing procedures on ships

- 2.1. This paragraph applies to:
 - 2.1.1. all passenger ships, not later than 1 January 2010;
 - 2.1.2. cargo ships constructed on or after 1 January 2010; and
 - 2.1.3. cargo ships constructed before 1 January 2010, not later than 1 January 2012.
- 2.2. Ships shall be provided with a ship-specific emergency towing procedure. Such a procedure shall be carried aboard the ship for use in emergency situations and shall be based on existing arrangements and equipment available on board the ship.
- 2.3. The procedure⁵ shall include:

¹ Refer to the guidelines to be developed by the Organization.

² Refer to the Guidelines for safe access to tanker bows adopted by the Maritime Safety Committee by resolution MSC.62(67).

³ Refer to the Guidelines on emergency towing arrangements for tankers, adopted by the Maritime Safety Committee by resolution MSC.35(63) as may be amended.

⁴ Refer to the Guidelines on emergency towing arrangements for tankers adopted by the Maritime Safety Committee by resolution MSC.35(63) as may be amended.

- 2.3.1. drawings of fore and aft deck showing possible emergency towing arrangements;
- 2.3.2. inventory of equipment on board that can be used for emergency towing;
- 2.3.3. means and methods of communication; and
- 2.3.4. sample procedures to facilitate the preparation for and conducting of emergency towing operations.

Regulation 3-5 – New installation and repairs of materials containing asbestos

1. This regulation shall apply to materials used for the structure, machinery, electrical installations and equipment covered by the SOLAS Convention.
2. For all ships, new installation of materials which contain asbestos *as well as repairs carried out using materials containing asbestos*⁶ shall be prohibited.

Regulation 3-6 – Access to and within spaces in the cargo area of oil tankers and bulk carriers

1. Application

- 1.1. Except as provided for in paragraph 1.2, this regulation applies to oil tankers of 500 gross tonnage and over and bulk carriers, as defined in regulation IX/1, of 20,000 gross tonnage and over, constructed on or after 1 January 2005.
- 1.2. Oil tankers of 500 gross tonnage and over constructed on or after 1 October 1994 but before 1 January 2005 shall comply with the provisions of regulation II-1/12-2 adopted by resolution MSC.27(61).

2. Means of access to cargo and other spaces

- 2.1. Each space within the cargo area shall be provided with a permanent means of access to enable, throughout the life of a ship, overall and close-up inspections and thickness measurements of the ship's structures to be carried out by the Administration, the Company, as defined in regulation IX/1, and the ship's personnel and others as necessary. Such means of access shall comply with the requirements of paragraph 5 and with the Technical provisions for means of access for inspections, adopted by the Maritime Safety Committee by resolution MSC.133(76), as may be amended by the Organization, provided that such amendments are adopted, brought into force and take effect in accordance with the provisions of article VIII of the SOLAS Convention concerning the amendment procedures applicable to the annex other than chapter 1.
- 2.2. Where a permanent means of access may be susceptible to damage during normal cargo loading and unloading operations or where it is impracticable to fit permanent means of access, the Administration may allow, in lieu thereof, the provision of movable or portable means of access, as specified in the Technical provisions, provided that the means of attaching, rigging, suspending or supporting the portable means of access forms a permanent part of the ship's structure. All portable equipment shall be capable of being readily erected or deployed by ship's personnel.
- 2.3. The construction and materials of all means of access and their attachment to the ship's structure shall be to the satisfaction of the Administration. The means of access shall be

⁵ Refer to the Guidelines for owners/operators on preparing emergency towing procedures (MSC.1/Circ.1255).

⁶ Attention is drawn to European Commission Directive 1999/77/EC on restrictions on the marketing and use of certain dangerous substances and preparations (asbestos) according to which the exceptions stipulated have lapsed in the EU member states as well as in countries covered by the EEA Agreement.

subject to survey prior to, or in conjunction with, its use in carrying out surveys in accordance with regulation I/10.

3. Safe access to cargo holds, cargo tanks, ballast tanks and other spaces

- 3.1. Safe access⁷ to cargo holds, cofferdams, ballast tanks, cargo tanks and other spaces in the cargo area shall be direct from the open deck and such as to ensure their complete inspection. Safe access to double bottom spaces or to ballast tanks forward of the cargo area may be from a pump-room, deep cofferdam, pipe tunnel, cargo hold, double hull space or similar compartment not intended for the carriage of oil or hazardous cargoes.
- 3.2. Tanks, and subdivisions of tanks, having a length of 35 m or more, shall be fitted with at least two access hatchways and ladders, as far apart as practicable. Tanks less than 35 m in length shall be served by at least one access hatchway and ladder. When a tank is subdivided by one or more swash bulkheads or similar obstructions which do not allow ready means of access to the other parts of the tank, at least two hatchways and ladders shall be fitted.
- 3.3. Each cargo hold shall be provided with at least two means of access as far apart as practicable. In general, these accesses should be arranged diagonally, for example one access near the forward bulkhead on the port side, the other one near the aft bulkhead on the starboard side.

4. Ship Structure Access Manual

- 4.1. A ship's means of access to carry out overall and close-up inspections and thickness measurements shall be described in a Ship Structure Access Manual approved by the Administration, an updated copy of which shall be kept on board. The Ship Structure Access Manual shall include the following for each space in the cargo area:
 - 4.1.1. plans showing the means of access to the space, with appropriate technical specifications and dimensions;
 - 4.1.2. plans showing the means of access within each space to enable an overall inspection to be carried out, with appropriate technical specifications and dimensions. The plans shall indicate from where each area in the space can be inspected;
 - 4.1.3. plans showing the means of access within the space to enable close-up inspections to be carried out, with appropriate technical specifications and dimensions. The plans shall indicate the positions of critical structural areas, whether the means of access is permanent or portable and from where each area can be inspected;
 - 4.1.4. instructions for inspecting and maintaining the structural strength of all means of access and means of attachment, taking into account any corrosive atmosphere that may be with the space;
 - 4.1.5. instructions for safety guidance when rafting is used for close-up inspections and thickness measurements;
 - 4.1.6. instructions for the rigging and use of any portable means of access in a safe manner;
 - 4.1.7. an inventory of all portable means of access; and
 - 4.1.8. records of periodical inspections and maintenance of the ship's means of access.
- 4.2. For the purpose of this regulation "critical structural areas" are locations which have been identified from calculations to require monitoring or from the service history of similar or

⁷ Refer to the Recommendations for entering enclosed spaces aboard ships, adopted by the Organization by resolution A.864(20).

sister ships to be sensitive to cracking, buckling, deformation or corrosion which would impair the structural integrity of the ship.

5. General technical specifications

- 5.1. For access through horizontal openings, hatches or manholes, the dimensions shall be sufficient to allow a person wearing a self-contained air-breathing apparatus and protective equipment to ascend or descend any ladder without obstruction and also provide a clear opening to facilitate the hoisting of an injured person from the bottom of the space. The minimum clear opening shall not be less than 600 mm x 600 mm. When access to a cargo hold is arranged through the cargo hatch, the top of the ladder shall be placed as close as possible to the hatch coaming. Access hatch coamings having a height greater than 900 mm shall also have steps on the outside in conjunction with the ladder.
- 5.2. For access through vertical openings, or manholes, in swash bulkheads, floors, girders and web frames providing passage through the length and breadth of the space, the minimum opening shall be not less than 600 mm x 800 mm at a height of not more than 600 mm from the bottom shell plating unless gratings or other foot holds are provided.
- 5.3. For oil tankers of less than 5,000 tonnes deadweight, the Administration may approve, in special circumstances, smaller dimensions for the openings referred to in paragraphs 5.1 and 5.2, if the ability to traverse such openings or to remove an injured person can be proved to the satisfaction of the Administration.

Regulation 3-7 Construction drawings maintained on board and ashore

1. A set of as-built construction drawings⁸ and other plans showing any subsequent structural alterations shall be kept on board a ship constructed on or after 1 January 2007.
2. An additional set of such drawings shall be kept ashore by the Company, as defined in regulation IX/1.2.

Regulation 3-8 – Towing and mooring equipment

1. This regulation applies to ships constructed on or after 1 January 2007, but does not apply to emergency towing arrangements provided in accordance with regulation 3-4.
2. Ships shall be provided with arrangements, equipment and fittings of sufficient safe working load to enable the safe conduct of all towing and mooring operations associated with the normal operation of the ship.
3. Arrangements, equipment and fittings provided in accordance with paragraph 2 shall meet the appropriate requirements of the Administration or an organization recognized by the Administration under regulation I/6⁹.
4. Each fitting or item of equipment provided under this regulation shall be clearly marked with any restrictions associated with its safe operation, taking into account the strength of its attachment to the ship's structure.

Regulation 3.9 – Means of embarkation on and disembarkation from ships

1. Ships constructed on or after 1 January 2010 shall be provided with means of embarkation on and disembarkation from ships for use in port and in port related operations, such as gangways and

⁸ Refer to MSC/Circ.1135 on As-built construction drawings to be maintained.

⁹ Refer to MSC/Circ. 1175 on Guidance on shipboard towing and mooring equipment.

accommodation ladders, in accordance with paragraph 2, unless the Administration deems that compliance with a particular provision is unreasonable or impractical.¹⁰

2. The means of embarkation and disembarkation required in paragraph 1 shall be constructed and installed based on the guidelines developed by the Organization.¹¹
3. For all ships the means of embarkation and disembarkation shall be inspected and maintained¹² in suitable condition for their intended purpose, taking into account any restrictions related to safe loading. All wires used to support the means of embarkation and disembarkation shall be maintained as specified in regulation III/20.4.

Regulation 3-10 – Guidelines for the construction and installation of suspended decks with associated safety devices in passenger ships

- 1.1 *In passenger ships fitted with suspended decks for the carriage of private cars, the construction and installation of movable platforms with associated ramps shall be made in accordance with the regulations used by a classification society and the following provisions.*
- 2 *The suspended end of each ramp shall be provided with an automatic fall arresting system, which shall protect the ramp in case of wire breaks or failure of the main hydraulic system. Fall arresting systems may, however, be replaced by a double wire system or any other equivalent arrangement.*
- 3 *A safety factor of 6 shall be used in relation to the breaking load on the components used in the lifting system.*
- 4 *Automatic emergency stop valves shall be installed in connection with the hydraulic installation for the operation of ramps and platforms.*
- 5 *The suspended end of each ramp shall be provided with an automatic safety fender, which shall engage as soon as the ramps are raised above deck. The height of such a safety fender shall be at least 200 mm. The sides of the ramps and platforms facing away from house sides or the like shall be provided with a safety fender of a height of at least 200 mm.*
- 6 *Above each end of each ramp, an illuminated warning notice shall be affixed with the following text:*

WALKING ON THE RAMP PROHIBITED – REMAIN IN YOUR CAR

(Danish text: FÆRDSEL PÅ RAMPEN FORBUDT – FORBLIV I BILEN)

The sign, which shall be visible to the drivers and passengers of vehicles parked on the ramp, shall be capable of being switched on and off manually, and be provided with automation to ensure that it is always switched on when the ramp is being manoeuvred. The sign shall be

¹⁰ Circumstances where compliance may be deemed unreasonable or impractical may include where the ship:

.1 has small freeboards and is provided with boarding ramps; or

.2 is engaged in voyages between designated ports where appropriate shore accommodation/embarkation ladders (platforms) are provided.

¹¹ Refer to the Guidelines for construction, installation, maintenance and inspection/survey of accommodation ladders and gangways, to be developed by the Organization.

¹² Refer to the Guidelines for construction, installation, maintenance and inspection/survey of accommodation ladders and gangways, to be developed by the Organization.

switched on before embarkation or disembarkation. The sign shall not be switched off until the ramp has been secured in the horizontal position.

- 7 *It shall be possible to secure platforms and ramps in the stowed position, and the ramps in both the horizontal working position and in the stowed position. Platforms and ramps may not be permanently suspended from the lifting system.*
- 8 *The necessary guard rails and guards shall be designed and located according to the regulations. In principle, the guard rails shall comply with the requirements for guard rails or rails stipulated in the Load Line Convention. It is not required that the guard rails be made with vertical posts.*
- 9 *Platforms and ramps shall be test-loaded in the presence of the Danish Maritime Authority or a recognised classification society in accordance with the provisions on the testing and initial inspection of lifting appliances stipulated in the technical regulation on lifting appliances and loose gear on ships¹³. Platforms shall be test-loaded with the loadings stipulated in the technical regulation if one or both edges are suspended from stays or wires. If the platform rests on permanent brackets at both edges, test-loading shall not be carried out, but the entire load-bearing structure shall be inspected.*
- 10 *Ramps shall be statically test-loaded (supported at the movable end) with the test loadings stipulated in the technical regulation on lifting appliances and loose gear.*
- 11 *Fall arrest systems shall not be tested with the ramp loaded, but a simulated release of the fall arrest shall be carried out with the ramp resting on trestles or the like. Where a double wire system has been installed instead of a fall arrest system, the ramps shall be test-loaded in the horizontal position with the loading mentioned above.*
- 12 *When ramp and platform lifting devices are being used, a load test shall be carried out of each platform and ramp during movement from working position to rest position (stowed position), or as close to this as possible with a test loading of 25% of the platform weight.*
- 13 *When the tests have been completed, the structure shall be thoroughly examined, and if any part of it shows deformation, cracking or any other damage of significance as far as safety is concerned, the damage shall be remedied and a new test may be required by order of the Danish Maritime Authority in each individual case.*
- 14 *Periodic surveys*
Periodic surveys shall be carried out in accordance with the provisions of the technical regulation on lifting appliances and loose gear on ships.
Functional tests and replacements shall be entered in the Register of ship's lifting appliances and loose gear.

¹³ Technical Regulation no. 12 of 12 October 2000 on lifting appliances and loose gear, etc. on ships issued by the Danish Maritime Authority.

APPENDIX

REVISED TECHNICAL PROVISIONS FOR MEANS OF ACCESS FOR INSPECTIONS¹⁴

1 Preamble

- 1.1 It has long been recognized that the only way of ensuring that the condition of a ship's structure is maintained to conform with the applicable requirements is for all its components to be surveyed on a regular basis throughout their operational life. This will ensure that they are free from damage such as cracks, buckling or deformation due to corrosion, overloading, or contact damage and that thickness diminution is within established limits. The provision of suitable means of access to the hull structure for the purpose of carrying out overall and close-up surveys and inspections is essential and such means should be considered and provided for at the ship design stage.
- 1.2 Ships should be designed and built with due consideration as to how they will be surveyed by flag State inspectors and classification society surveyors during their in-service life and how the crew will be able to monitor the condition of the ship. Without adequate access, the structural condition of the ship can deteriorate undetected and major structural failure can arise. A comprehensive approach to design and maintenance is required to cover the whole projected life of the ship.
- 1.3 In order to address this issue, the Organization has developed these Technical provisions for means of access for inspections (hereinafter called the Technical provisions.), intended to facilitate close-up inspections and thickness measurements of the ship's structure referred to in SOLAS regulation II-1/3-6 on access to and within spaces in, and forward of, the cargo area of oil tankers and bulk carriers. The Technical provisions do not apply to the cargo tanks of combined chemical/oil tankers complying with the provisions of the IBC Code.
- 1.4 Permanent means of access which are designed to be integral parts of the structure itself are preferred and Administrations may allow reasonable deviations to facilitate such designs.

2 Definitions

For the purpose of these Technical provisions, the following definitions apply in addition to those provided in the 1974 SOLAS Convention, as amended, and in resolution A.744(18), as amended:

- .1 "Rung" means the step of a vertical ladder or step on the vertical surface.
- .2 "Tread" means the step of an inclined ladder or step for the vertical access opening.
- .3 "Flight of an inclined ladder" means the actual stringer length of an inclined ladder. For vertical ladders, it is the distance between the platforms.
- .4 "Stringer" means:
 - .1 the frame of a ladder; or
 - .2 the stiffened horizontal plating structure fitted on the side shell, transverse bulkheads and/or longitudinal bulkheads in the space. For the purpose of ballast tanks of less than 5 m width forming double side spaces, the horizontal plating structure is credited as a stringer and a longitudinal permanent means of access, if it provides a continuous passage of 600 mm or more in width past frames or stiffeners on the side shell or longitudinal bulkhead. Openings in stringer plating utilized as permanent means of access shall be arranged with guard rails or grid covers to provide safe passage on the stringer or safe access to each transverse web.
- .5 "Vertical ladder" means a ladder of which the inclined angle is 70° and over up to 90°. A vertical ladder shall not be skewed by more than 2°.

¹⁴ The text is a copy of MSC Resolution MSC.158(78), Adoption of technical provisions for means of access for inspections.

- .6 “Overhead obstructions” mean the deck or stringer structure including stiffeners above the means of access.
- .7 “Distance below deck head” means the distance below the plating.
- .8 “Cross deck” means the transverse area of the main deck which is located inboard and between hatch coamings.

3 Technical provisions

- 3.1 Structural members subject to the close-up inspections and thickness measurements of the ship’s structure referred to in SOLAS regulation II-1/3-6, except those in double bottom spaces, shall be provided with a permanent means of access to the extent as specified in table 1 and table 2, as applicable. For oil tankers and wing ballast tanks of ore carriers, approved alternative methods may be used in combination with the fitted permanent means of access, provided that the structure allows for its safe and effective use.
- 3.2 Permanent means of access should as far as possible be integral to the structure of the ships, thus ensuring that they are robust and at the same time contributing to the overall strength of the structure of the ship.
- 3.3 Elevated passageways forming sections of a permanent means of access, where fitted, shall have a minimum clear width of 600 mm, except for going around vertical webs where the minimum clear width may be reduced to 450 mm, and have guard rails over the open side of their entire length. Sloping structures providing part of the access shall be of a non-skid construction. Guard rails shall be 1,000 mm in height and consist of a rail and an intermediate bar 500 mm in height and of substantial construction. Stanchions shall be not more than 3 m apart.
- 3.4 Access to permanent means of access and vertical openings from the ship’s bottom shall be provided by means of easily accessible passageways, ladders or treads. Treads shall be provided with lateral support for the foot. Where the rungs of ladders are fitted against a vertical surface, the distance from the centre of the rungs to the surface shall be at least 150 mm. Where vertical manholes are fitted higher than 600 mm above the walking level, access shall be facilitated by means of treads and hand grips with platform landings on both sides.
- 3.5 Permanent inclined ladders shall be inclined at an angle of less than 70°. There shall be no obstructions within 750 mm of the face of the inclined ladder, except that in way of an opening this clearance may be reduced to 600 mm. Resting platforms of adequate dimensions shall be provided, normally at a maximum of 6 m vertical height. Ladders and handrails shall be constructed of steel or equivalent material of adequate strength and stiffness and securely attached to the structure by stays. The method of support and length of stay shall be such that vibration is reduced to a practical minimum. In cargo holds, ladders shall be designed and arranged so that cargo handling difficulties are not increased and the risk of damage from cargo handling gear is minimized.
- 3.6 The width of inclined ladders between stringers shall not be less than 400 mm. The treads shall be equally spaced at a distance apart, measured vertically, of between 200 mm and 300 mm. When steel is used, the treads shall be formed of two square bars of not less than 22 mm by 22 mm in section, fitted to form a horizontal step with the edges pointing upward. The treads shall be carried through the side stringers and attached thereto by double continuous welding. All inclined ladders shall be provided with handrails of substantial construction on both sides, fitted at a convenient distance above the treads.
- 3.7 For vertical ladders or spiral ladders, the width and construction should be in accordance with international or national standards accepted by the Administration.
- 3.8 No free-standing portable ladder shall be more than 5 m long.
- 3.9 Alternative means of access include, but are not limited to, such devices as:
 - .1 hydraulic arm fitted with a stable base;
 - .2 wire lift platform;
 - .3 staging;
 - .4 rafting;
 - .5 robot arm or remotely operated vehicle (ROV);

- .6 portable ladders more than 5 m long shall only be utilized if fitted with a mechanical device to secure the upper end of the ladder;
 - .7 other means of access, approved by and acceptable to the Administration. Means for safe operation and rigging of such equipment to and from and within the spaces shall be clearly described in the Ship Structure Access Manual.
- 3.10 For access through horizontal openings, hatches or manholes, the minimum clear opening shall not be less than 600 mm x 600 mm. When access to a cargo hold is arranged through the cargo hatch, the top of the ladder shall be placed as close as possible to the hatch coaming. Access hatch coamings having a height greater than 900 mm shall also have steps on the outside in conjunction with the ladder.
- 3.11 For access through vertical openings, or manholes, in swash bulkheads, floors, girders and web frames providing passage through the length and breadth of the space, the minimum opening shall be not less than 600 mm x 800 mm at a height of not more than 600 mm from the passage unless gratings or other foot holds are provided.
- 3.12 For oil tankers of less than 5,000 tonnes deadweight, the Administration may approve, in special circumstances, smaller dimensions for the openings referred to in paragraphs 3.10 and 3.11, if the ability to traverse such openings or to remove an injured person can be proved to the satisfaction of the Administration.
- 3.13 For bulk carriers, access ladders to cargo holds and other spaces shall be:
- .1 Where the vertical distance between the upper surface of adjacent decks or between deck and the bottom of the cargo space is not more than 6 m, either a vertical ladder or an inclined ladder.
 - .2 Where the vertical distance between the upper surface of adjacent decks or between deck and the bottom of the cargo space is more than 6 m, an inclined ladder or series of inclined ladders at one end of the cargo hold, except the uppermost 2.5 m of a cargo space measured clear of overhead obstructions and the lowest 6 m may have vertical ladders, provided that the vertical extent of the inclined ladder or ladders connecting the vertical ladders is not less than 2.5 m. The second means of access at the other end of the cargo hold may be formed of a series of staggered vertical ladders, which should comprise of one or more ladder linking platforms spaced not more than 6 m apart vertically and displaced to one side of the ladder. Adjacent sections of ladder should be laterally offset from each other by at least the width of the ladder. The uppermost entrance section of the ladder directly exposed to a cargo hold should be vertical for a distance of 2.5 m measured clear of overhead obstructions and connected to a ladder-linking platform.
 - .3 A vertical ladder may be used as a means of access to topside tanks, where the vertical distance is 6 m or less between the deck and the longitudinal means of access in the tank or the stringer or the bottom of the space immediately below the entrance. The uppermost entrance section from deck of the vertical ladder of the tank should be vertical for a distance of 2.5 m measured clear of overhead obstructions and comprise a ladder linking platform, unless landing on the longitudinal means of access, the stringer or the bottom within the vertical distance, displaced to one side of a vertical ladder.
 - .4 Unless allowed in .3 above, an inclined ladder or combination of ladders should be used for access to a tank or a space where the vertical distance is greater than 6 m between the deck and a stringer immediately below the entrance, between stringers, or between the deck or a stringer and the bottom of the space immediately below the entrance.
 - .5 In case of .4 above, the uppermost entrance section from deck of the ladder should be vertical for a distance of 2.5 m clear of overhead obstructions and connected to a landing platform and continued with an inclined ladder. The flights of inclined ladders should not be more than 9 m in actual length and the vertical height should not normally be more than 6 m. The lowermost section of the ladders may be vertical for a distance of not less than 2.5 m.
 - .6 In double-side skin spaces of less than 2.5 m width, the access to the space may be by means of vertical ladders that comprise of one or more ladder linking platforms spaced not more than 6 m

apart vertically and displaced to one side of the ladder. Adjacent sections of ladder should be laterally offset from each other by at least the width of the ladder.

- .7 A spiral ladder is considered acceptable as an alternative for inclined ladders. In this regard, the uppermost 2.5 m can continue to be comprised of the spiral ladder and need not change over to vertical ladders.
- 3.14 The uppermost entrance section from deck of the vertical ladder providing access to a tank should be vertical for a distance of 2.5 m measured clear of overhead obstructions and comprise a ladder linking platform, displaced to one side of a vertical ladder. The vertical ladder can be between 1.6 m and 3 m below deck structure if it lands on a longitudinal or athwartship permanent means of access fitted within that range.

Table 1 – Means of access for ballast and cargo tanks of oil tankers

1 Water ballast tanks, except those specified in 2, and cargo oil tanks

Access to the underdeck and vertical structure

- 1.1 For tanks of which the height is 6 m and over containing internal structures, permanent means of access shall be provided in accordance with .1 to .6:
 - .1 continuous athwartship permanent access arranged at each transverse bulkhead on the stiffened surface, at a minimum of 1.6 m to a maximum of 3 m below the deck head;
 - .2 at least one continuous longitudinal permanent means of access at each side of the tank. One of these accesses shall be at a minimum of 1.6 m to a maximum of 6 m below the deck head and the other shall be at a minimum of 1.6 m to a maximum of 3 m below the deck head;
 - .3 access between the arrangements specified in .1 and .2 and from the main deck to either .1 or .2;
 - .4 continuous longitudinal permanent means of access which are integrated in the structural member on the stiffened surface of a longitudinal bulkhead, in alignment, where possible, with horizontal girders of transverse bulkheads are to be provided for access to the transverse webs unless permanent fittings are installed at the uppermost platform for use of alternative means, as defined in paragraph 3.9 of the Technical provisions, for inspection at intermediate heights;
 - .5 for ships having cross-ties which are 6 m or more above tank bottom, a transverse permanent means of access on the cross-ties providing inspection of the tie flaring brackets at both sides of the tank, with access from one of the longitudinal permanent means of access in .4; and
 - .6 alternative means as defined in paragraph 3.9 of the Technical provisions may be provided for small ships as an alternative to .4 for cargo oil tanks of which the height is less than 17 m.
- 1.2 For tanks of which the height is less than 6 m, alternative means as defined in paragraph 3.9 of the Technical provisions or portable means may be utilized in lieu of the permanent means of access.

Fore peak tanks

- 1.3 For fore peak tanks with a depth of 6 m or more at the centre line of the collision bulkhead, a suitable means of access shall be provided for access to critical areas such as the underdeck structure, stringers, collision bulkhead and side shell structure.
 - 1.3.1 Stringers of less than 6 m in vertical distance from the deck head or a stringer immediately above are considered to provide suitable access in combination with portable means of access.
 - 1.3.2 In case the vertical distance between the deck head and stringers, stringers or the lowest stringer and the tank bottom is 6 m or more, alternative means of access as defined in paragraph 3.9 of the Technical provisions shall be provided.

2 Water ballast wing tanks of less than 5 m width forming double side spaces and their bilge hopper sections

Access to the underdeck and vertical structure

- 2.1 For double side spaces above the upper knuckle point of the bilge hopper sections, permanent means of access are to be provided in accordance with .1 to .3:
- .1 where the vertical distance between horizontal uppermost stringer and deck head is 6 m or more, one continuous longitudinal permanent means of access shall be provided for the full length of the tank with a means to allow passing through transverse webs installed at a minimum of 1.6 m to a maximum of 3 m below the deck head with a vertical access ladder at each end of the tank;
 - .2 continuous longitudinal permanent means of access, which are integrated in the structure, at a vertical distance not exceeding 6 m apart; and
 - .3 plated stringers shall, as far as possible, be in alignment with horizontal girders of transverse bulkheads.
- 2.2 For bilge hopper sections of which the vertical distance from the tank bottom to the upper knuckle point is 6 m and over, one longitudinal permanent means of access shall be provided for the full length of the tank. It shall be accessible by vertical permanent means of access at each end of the tank.
- 2.2.1 The longitudinal continuous permanent means of access may be installed at a minimum 1.6 m to maximum 3 m from the top of the bilge hopper section. In this case, a platform extending the longitudinal continuous permanent means of access in way of the webframe may be used to access the identified structural critical areas.
- 2.2.2 Alternatively, the continuous longitudinal permanent means of access may be installed at a minimum of 1.2 m below the top of the clear opening of the web ring allowing a use of portable means of access to reach identified structural critical areas.
- 2.3 Where the vertical distance referred to in 2.2 is less than 6 m, alternative means as defined in paragraph 3.9 of the Technical provisions or portable means of access. To facilitate the operation of the alternative means of access, in-line openings in horizontal stringers shall be provided. The openings shall be of an adequate diameter and shall have suitable protective railings.

Table 2 – Means of access for bulk carriers¹⁵

1 Cargo holds

Access to underdeck structure

- 1.1 Permanent means of access shall be fitted to provide access to the overhead structure at both sides of the cross deck and in the vicinity of the centreline. Each means of access shall be accessible from the cargo hold access or directly from the main deck and installed at a minimum of 1.6 m to a maximum of 3 m below the deck.
- 1.2 An athwartship permanent means of access fitted on the transverse bulkhead at a minimum 1.6 m to a maximum 3 m below the cross-deck head is accepted as equivalent to 1.1.
- 1.3 Access to the permanent means of access to overhead structure of the cross deck may also be via the upper stool.
- 1.4 Ships having transverse bulkheads with full upper stools with access from the main deck which allows monitoring of all framing and plates from inside do not require permanent means of access of the cross deck.
- 1.5 Alternatively, movable means of access may be utilized for access to the overhead structure of the cross deck if its vertical distance is 17 m or less above the tank top.

¹⁵ For ore carriers, permanent means of access shall be provided in accordance with the applicable sections of table 1 and table 2.

Access to vertical structures

- 1.6 Permanent means of vertical access shall be provided in all cargo holds and built into the structure to allow for an inspection of a minimum of 25% of the total number of hold frames port and starboard equally distributed throughout the hold including at each end in way of transverse bulkheads. But in no circumstance shall this arrangement be less than 3 permanent means of vertical access fitted to each side (fore and aft ends of hold and mid-span). Permanent means of vertical access fitted between two adjacent hold frames is counted for an access for the inspection of both hold frames. A means of portable access may be used to gain access over the sloping plating of lower hopper ballast tanks.
- 1.7 In addition, portable or movable means of access shall be utilized for access to the remaining hold frames up to their upper brackets and transverse bulkheads.
- 1.8 Portable or movable means of access may be utilized for access to hold frames up to their upper bracket in place of the permanent means required in 1.6. These means of access shall be carried on board the ship and readily available for use.
- 1.9 The width of vertical ladders for access to hold frames shall be at least 300 mm, measured between stringers.
- 1.10 A single vertical ladder over 6 m in length is acceptable for the inspection of the hold side frames in a single skin construction.
- 1.11 For double-side skin construction no vertical less than 6 m, alternative means as defined in ladders for the inspection of the cargo hold surfaces are required. Inspection of this structure should be provided from within the double hull space.

2 Ballast tanks

Top side tanks

- 2.1 For each topside tank of which the height is 6 m and over, one longitudinal continuous permanent means of access shall be provided along the side shell webs and installed at a minimum of 1.6 m to a maximum of 3 m below deck with a vertical access ladder in the vicinity of each access to that tank.
- 2.2 If no access holes are provided through the transverse webs within 600 mm of the tank base and the web frame rings have a web height greater than 1 m in way of side shell and sloping plating, then step rungs/grab rails shall be provided to allow safe access over each transverse web frame ring.
- 2.3 Three permanent means of access, fitted at the end bay and middle bay of each tank, shall be provided spanning from tank base up to the intersection of the sloping plate with the hatch side girder. The existing longitudinal structure, if fitted on the sloping plate in the space may be used as part of this means of access.
- 2.4 For topside tanks of which the height is less than 6 m, alternative means as defined in paragraph 3.9 of the Technical provisions or portable means may be utilized in lieu of the permanent means of access.

Bilge hopper tanks

- 2.5 For each bilge hopper tank of which the height is 6 m and over, one longitudinal continuous permanent means of access shall be provided along the side shell webs and installed at a minimum of 1.2 m below the top of the clear opening of the web ring with a vertical access ladder in the vicinity of each access to the tank.
 - 2.5.1 An access ladder between the longitudinal continuous permanent means of access and the bottom of the space shall be provided at each end of the tank.
 - 2.5.2 Alternatively, the longitudinal continuous permanent means of access can be located through the upper web plating above the clear opening of the web ring, at a minimum of 1.6 m below the deck head, when this arrangement facilitates more suitable inspection of identified structurally critical areas. An enlarged longitudinal frame can be used for the purpose of the walkway.

- 2.5.3 For double skin bulk carriers, the longitudinal continuous permanent means of access may be installed within 6 m from the knuckle point of the bilge, if used in combination with alternative methods to gain access to the knuckle point.
- 2.6 If no access holes are provided through the transverse ring webs within 600 mm of the tank base and the web frame rings have a web height greater than 1 m in way of side shell and sloping plating, then step rungs/grab rails shall be provided to allow safe access over each transverse web frame ring.
- 2.7 For bilge hopper tanks of which the height is less than 6 m, alternative means as defined in paragraph 3.9 of the Technical provisions or portable means may be utilized in lieu of the permanent means of access. Such means of access shall be demonstrated that they can be deployed and made readily available in the areas where needed.

Double-skin side tanks

- 2.8 Permanent means of access shall be provided in accordance with the applicable sections of table 1.

Fore peak tanks

- 2.9 For fore peak tanks with a depth of 6 m or more at the centreline of the collision bulkhead, a suitable means of access shall be provided for access to critical areas such as the underdeck structure, stringers, collision bulkhead and side shell structure.
 - 2.9.1 Stringers of less than 6 m in vertical distance from the deck head or a stringer immediately above are considered to provide suitable access in combination with portable means of access.
 - 2.9.2 In case the vertical distance between the deck head and stringers, stringers or the lowest stringer and the tank bottom is 6 m or more, alternative means of access as defined in paragraph 3.9 of the Technical provisions shall be provided.

**Notice from the Danish Maritime Authority B –
The Construction and Equipment, etc. of Ships**

Chapter B II-1 B, B-1

Construction – Structure, subdivision and stability, machinery and electrical installations

Regulation 4 – General	1
Regulation 5 – Intact stability	2
Regulation 5-1 – Stability information to be supplied to the master	3
Regulation 6 – Required subdivision index R	3
Regulation 7 – Attained subdivision index A	4
Regulation 7-1 – Calculation of the factor p_i	5
Regulation 7-2 – Calculation of the factor s_i	10
Regulation 7-3 – Permeability	15
Regulation 8 – Special requirements concerning passenger ship stability	15
Regulation 8-1 – System capabilities after a flooding casualty on passenger ships	16

Part B – Subdivision and Stability

Regulation 4 – General

1. The damage stability requirements in Parts B-1 through B-4 shall apply to cargo ships of 80 m in length (L) and upwards and to all passenger ships regardless of length but shall exclude those cargo ships which are shown to comply with subdivision and damage stability regulations in other instruments¹ developed by the Organization.
2. The Administration may, for a particular ship or group of ships, accept alternative methodologies if it is satisfied that at least the same degree of safety as represented by these regulations is achieved. Any Administration which allows such alternative methodologies shall communicate to the Organization particulars thereof.

¹ Cargo ships shown to comply with the following regulations may be excluded from the application of part B-1:

.1 Annex I to MARPOL 73/78, except OBO ships with type B freeboards are not excluded;

.2 International Bulk Chemical Code;

.3 International Gas Carrier Code;

.4 Guidelines for the design and construction of offshore supply vessels (resolution A.469(XII));

.5 Code of Safety for Special Purpose Ships (resolution A.534(13), as amended);

.6 Damage stability requirements of regulation 27 of the 1988 Load Lines Protocol as applied in compliance with resolutions A.320(IX) and A.514(13), provided that in the case of cargo ships to which regulation 27(9) applies, main transverse watertight bulkheads, to be considered effective, are spaced according to paragraph (12)(f) of resolution A.320(IX), except ships intended for the carriage of deck cargo; and

.7 Damage stability requirements of regulation 27 of the 1988 Load Lines Protocol, except ships intended for the carriage of deck cargo.

3. Ships shall be as efficiently subdivided as is possible having regard to the nature of the service for which they are intended. The degree of subdivision shall vary with the subdivision length (L_s) of the ship and with the service, in such manner that the highest degree of subdivision corresponds with the ships of greatest subdivision length (L_s), primarily engaged in the carriage of passengers.
4. Where it is proposed to fit decks, inner skins or longitudinal bulkheads of sufficient tightness to seriously restrict the flow of water, the Administration shall be satisfied that proper consideration is given to beneficial or adverse effects of such structures in the calculations.

Part B-1 – Stability

Regulation 5 – Intact stability

1. Every passenger ship regardless of size and every cargo ship having a length (L) of 24 m and upwards, shall be inclined upon its completion and the elements of its stability determined. In addition to any other applicable requirements of the present regulations, ships having a length of 24 m and upwards constructed on or after 1 July 2010 shall as a minimum comply with the requirements of part A of the 2008 IS Code.
2. The Administration may allow the inclining test of an individual cargo ship to be dispensed with provided basic stability data are available from the inclining test of a sister ship and it is shown to the satisfaction of the Administration that reliable stability information for the exempted ship can be obtained from such basic data, as required by regulation 5-1. A weight survey shall be carried out upon completion and the ship shall be inclined whenever in comparison with the data derived from the sister ship, a deviation from the lightship displacement exceeding 1% for ships of 160 m or more in length and 2% for ships of 50 m or less in length and as determined by linear interpolation for intermediate lengths or a deviation from the lightship longitudinal centre of gravity exceeding 0.5% of L_s is found.
3. The Administration may also allow the inclining test of an individual ship or class of ships especially designed for the carriage of liquids or ore in bulk to be dispensed with when reference to existing data for similar ships clearly indicates that due to the ship's proportions and arrangements more than sufficient metacentric height will be available in all probable loading conditions.
4. Where any alterations are made to a ship so as to materially affect the stability information supplied to the master, amended stability information shall be provided. If necessary the ship shall be re-inclined. The ship shall be re-inclined if anticipated deviations exceed one of the values specified in paragraph 5.
5. At periodical intervals not exceeding five years, a lightweight survey shall be carried out on all passenger ships to verify any changes in lightship displacement and longitudinal centre of gravity. The ship shall be re-inclined whenever, in comparison with the approved stability information, a deviation from the lightship displacement exceeding 2% or a deviation of the longitudinal centre of gravity exceeding 1% of L_s is found or anticipated.
6. Every ship shall have scales of draughts marked clearly at the bow and stern. In the case where the draught marks are not located where they are easily readable, or operational constraints for a particular trade make it difficult to read the draught marks, then the ship shall also be fitted with a reliable draught indicating system by which the bow and stern draughts can be determined.

Regulation 5-1 – Stability information to be supplied to the master²

1. The master shall be supplied with such information satisfactory to the Administration as is necessary to enable him by rapid and simple processes to obtain accurate guidance as to the stability of the ship under varying conditions of service. A copy of the stability information shall be furnished to the Administration.
2. The information should include:
 - 2.1. curves or tables of minimum operational metacentric height (GM) versus draught which assures compliance with the relevant intact and damage stability requirements, alternatively corresponding curves or tables of the maximum allowable vertical centre of gravity (KG) versus draught, or with the equivalents of either of these curves;
 - 2.2. instructions concerning the operation of cross-flooding arrangements; and
 - 2.3. all other data and aids which might be necessary to maintain the required intact stability and stability after damage.
3. The stability information shall show the influence of various trims in cases where the operational trim range exceeds $\pm 0.5\%$ of L_s .
4. For ships which have to fulfil the stability requirements of part B-1, information referred to in paragraph 2 are determined from considerations related to the subdivision index, in the following manner: Minimum required GM (or maximum permissible vertical position of centre of gravity KG) for the three draughts d_s , d_p and d_l are equal to the GM (or KG values) of corresponding loading cases used for the calculation of survival factor s_i . For intermediate draughts, values to be used shall be obtained by linear interpolation applied to the GM value only between the deepest subdivision draught and the partial subdivision draught and between the partial load line and the light service draught respectively. Intact stability criteria will also be taken into account by retaining for each draft the maximum among minimum required GM values or the minimum of maximum permissible KG values for both criteria. If the subdivision index is calculated for different trims, several required GM curves will be established in the same way.
5. When curves or tables of minimum operational metacentric height (GM) versus draught are not appropriate, the master should ensure that the operating condition does not deviate from a studied loading condition, or verify by calculation that the stability criteria are satisfied for this loading condition.

Regulation 6 – Required subdivision index R ³

1. The subdivision of a ship is considered sufficient if the attained subdivision index A , determined in accordance with regulation 7, is not less than the required subdivision index R calculated in accordance with this regulation and if, in addition, the partial indices A_s , A_p and A_l are not less than $0.9R$ for passenger ships and $0.5R$ for cargo ships.
2. For all ships to which the damage stability requirements of this chapter apply, the degree of subdivision to be provided shall be determined by the required subdivision index R , as follows:
 - 2.1. In the case of cargo ships greater than 100 m in length (L_s):

² Refer also to the Guidelines for the preparation of intact stability information (MSC/Circ.456); Guidance on the intact stability of existing tankers during transfer operations (MSC/Circ.706); and the Guidance to the master for avoiding dangerous situations in following and quartering seas (MSC.1/Circ.1228). *Furthermore, reference is made to the most recent guidance on the approval of ship stability issued by the Danish Maritime Authority.*

³ The Maritime Safety Committee, in adopting the regulations contained in parts B to B-4, invited Administrations to note that the regulations should be applied in conjunction with the explanatory notes developed by the Organization in order to ensure their uniform application.

$$R = 1 - \frac{128}{L_s + 152}$$

2.2. In the case of cargo ships not less than 80 m in length (L_s) and not greater than 100 m in length

$$R = 1 - [1 / (1 + \frac{L_s}{100} \times \frac{R_o}{1 - R_o})]$$

Where R_o is the value R as calculated in accordance with the formula in subparagraph .1.

2.3. .In the case of passenger ships:

$$R = 1 - \frac{5,000}{L_s + 2.5N + 15,225}$$

where:

$$N = N_1 + 2N_2$$

N_1 = number of persons for whom lifeboats are provided

N_2 = number of persons (including officers and crew) the ship is permitted to carry in excess of N_1 .

2.4. Where the conditions of service are such that compliance with paragraph 2.3 of this regulation on the basis of $N = N_1 + 2N_2$ is impracticable and where the Administration considers that a suitably reduced degree of hazard exists, a lesser value of N may be taken but in no case less than $N = N_1 + N_2$.

Regulation 7 – Attained subdivision index A

1. The attained subdivision index A is obtained by the summation of the partial indices A_s , A_p and A_l (weighted as shown) calculated for the draughts d_s , d_p and d_l defined in regulation 2 in accordance with the following formula:

$$A = 0.4A_s + 0.4A_p + 0.2A_l$$

Each partial index is a summation of contributions from all damage cases taken in consideration, using the following formula:

$$A = \sum p_i s_i$$

where:

i represents each compartment or group of compartments under consideration,

p_i accounts for the probability that only the compartment or group of compartments under consideration may be flooded, disregarding any horizontal subdivision, as defined in regulation 7-1,

s_i accounts for the probability of survival after flooding the compartment or group of compartments under consideration, and includes the effect of any horizontal subdivision, as defined in regulation 7-2.

2. In the calculation of A , the level trim shall be used for the deepest subdivision draught and the partial subdivision draught. The actual service trim shall be used for the light service draught. If in any service condition, the trim variation in comparison with the calculated trim is greater than 0.5% of L_s , one or more additional calculations of A are to be submitted for the same draughts but different trims so that, for all service conditions, the difference in trim in comparison with the reference trim used for one calculation will be less than 0.5% of L_s .
3. When determining the positive righting lever (GZ) of the residual stability curve, the displacement used should be that of the intact condition. That is, the constant displacement method of calculation should be used.
4. The summation indicated by the above formula shall be taken over the ship's subdivision length (L_s) for all cases of flooding in which a single compartment or two or more adjacent compartments are involved. In the case of unsymmetrical arrangements, the calculated A value should be the mean value obtained from calculations involving both sides. Alternatively, it should be taken as that corresponding to the side which evidently gives the least favourable result.
5. Wherever wing compartments are fitted, contribution to the summation indicated by the formula shall be taken for all cases of flooding in which wing compartments are involved. Additionally, cases of simultaneous flooding of a wing compartment or group of compartments and the adjacent inboard compartment or group of compartments, but excluding damage of transverse extent greater than one half of the ship breadth B , may be added. For the purpose of this regulation, transverse extent is measured inboard from ship's side, at right angle to the centreline at the level of the deepest subdivision draught.
6. In the flooding calculations carried out according to the regulations, only one breach of the hull and only one free surface need to be assumed. The assumed vertical extent of damage is to extend from the baseline upwards to any watertight horizontal subdivision above the waterline or higher. However, if a lesser extent of damage will give a more severe result, such extent is to be assumed.
7. If pipes, ducts or tunnels are situated within the assumed extent of damage, arrangements are to be made to ensure that progressive flooding cannot thereby extend to compartments other than those assumed flooded. However, the Administration may permit minor progressive flooding if it is demonstrated that its effects can be easily controlled and the safety of the ship is not impaired.

Regulation 7-1 – Calculation of the factor p_i

1. The factor p_i for a compartment or group of compartments shall be calculated in accordance with paragraphs 1.1 and 1.2 using the following notations:

j = the aftmost damage zone number involved in the damage starting with no. 1 at the stern;

n = the number of adjacent damage zones involved in the damage;

k = is the number of a particular longitudinal bulkhead as barrier for transverse penetration in a damage zone counted from shell towards the centre line. The shell has k = 0;

x1 = the distance from the aft terminal of L_s to the aft end of the zone in question;

x2 = the distance from the aft terminal of L_s to the forward end of the zone in question;

b = the mean transverse distance in metres measured at right angles to the centreline at the deepest subdivision loadline between the shell and an assumed vertical plane extended between the longitudinal limits used in calculating the factor p_i and which is a tangent to, or common with, all or part of the outermost portion of the longitudinal bulkhead under consideration. This vertical plane shall be so orientated that the mean transverse distance to the shell is a maximum, but not more than twice the least distance between the plane and the shell. If the upper part of a longitudinal bulkhead is below the deepest subdivision loadline the vertical plane used for determination of b is assumed to extend upwards to the deepest subdivision waterline. In any case, b is not to be taken greater than B/2.

If the damage involves a single zone only:

$$p_i = p(x1_j, x2_j) \cdot [r(x1_j, x2_j, b_k) - r(x1_j, x2_j, b_{k-1})]$$

If the damage involves two adjacent zones:

$$p_i = p(x1_j, x2_{j+1}) \cdot [r(x1_j, x2_{j+1}, b_k) - r(x1_j, x2_{j+1}, b_{k-1})] \\ - p(x1_j, x2_j) \cdot [r(x1_j, x2_j, b_k) - r(x1_j, x2_j, b_{k-1})] \\ - p(x1_{j+1}, x2_{j+1}) \cdot [r(x1_{j+1}, x2_{j+1}, b_k) - r(x1_{j+1}, x2_{j+1}, b_{k-1})]$$

If the damage involves three or more adjacent zones:

$$p_i = p(x1_j, x2_{j+n-1}) \cdot [r(x1_j, x2_{j+n-1}, b_k) - r(x1_j, x2_{j+n-1}, b_{k-1})] \\ - p(x1_j, x2_{j+n-2}) \cdot [r(x1_j, x2_{j+n-2}, b_k) - r(x1_j, x2_{j+n-2}, b_{k-1})] \\ - p(x1_{j+1}, x2_{j+n-1}) \cdot [r(x1_{j+1}, x2_{j+n-1}, b_k) - r(x1_{j+1}, x2_{j+n-1}, b_{k-1})] \\ + p(x1_{j+1}, x2_{j+n-2}) \cdot [r(x1_{j+1}, x2_{j+n-2}, b_k) - r(x1_{j+1}, x2_{j+n-2}, b_{k-1})]$$

and where $r(x1, x2, b_0) = 0$

1.1 The factor $p(x1, x2)$ is to be calculated according to the following formulae:

Overall normalized max damage length:	$J_{\max} = 10/33$
Knuckle point in the distribution:	$J_{kn} = 5/33$
Cumulative probability at J_{kn} :	$p_k = 11/12$
Maximum absolute damage length:	$l_{\max} = 60 \text{ m}$
Length where normalized distribution ends:	$L^* = 260 \text{ m}$

Probability density at $J = 0$:

$$b_0 = 2 \left(\frac{p_k}{J_{kn}} - \frac{1 - p_k}{J_{\max} - J_{kn}} \right)$$

When : $L_s \leq L^*$

$$J_m = \min \left\{ J_{\max}, \frac{l_{\max}}{L_s} \right\}$$

$$J_k = \frac{J_m}{2} + \frac{1 - \sqrt{1 + (1 - 2p_k)b_0 J_m + \frac{1}{4}b_0^2 J_m^2}}{b_0}$$

$$b_{12} = b_0$$

When : $L_s > L^*$

$$J_m^* = \min \left\{ J_{\max}, \frac{l_{\max}}{L^*} \right\}$$

$$J_k^* = \frac{J_m^*}{2} + \frac{1 - \sqrt{1 + (1 - 2p_k)b_0 J_m^* + \frac{1}{4}b_0^2 J_m^{*2}}}{b_0}$$

$$J_m = \frac{J_m^* \cdot L^*}{L_s}$$

$$J_k = \frac{J_k^* \cdot L^*}{L_s}$$

$$b_{12} = 2 \left(\frac{p_k}{J_k} - \frac{1 - p_k}{J_m - J_k} \right)$$

$$b_{11} = 4 \frac{1 - p_k}{(J_m - J_k)J_k} - 2 \frac{p_k}{J_k^2}$$

$$b_{21} = -2 \frac{1 - p_k}{(J_m - J_k)^2}$$

$$b_{22} = -b_{21} J_m$$

The non-dimensional damage length:

$$J = \frac{(x_2 - x_1)}{L_s}$$

The normalized length of a compartment or group of compartments:

J_n is to be taken as the lesser of J and J_m

1.1.1 Where neither limits of the compartment or group of compartments under consideration coincides with the aft or forward terminals:

$J \leq J_k$:

$$p(x_1, x_2) = p_1 = \frac{1}{6} J^2 (b_{11} J + 3b_{12})$$

$J > J_k$:

$$\begin{aligned} p(x_1, x_2) = p_2 = & -\frac{1}{3} b_{11} J_k^3 + \frac{1}{2} (b_{11} J - b_{12}) J_k^2 \\ & + b_{12} J J_k - r(x_1, x_2, b) = 1 - (1 - C) \cdot \left[1 - \frac{G}{p(x_1, x_2)} \right] \\ & + \frac{1}{2} (b_{21} J - b_{22}) (J_n^2 - J_k^2) + b_{22} J (J_n - J_k) \end{aligned}$$

1.1.2 Where the aft limit of the compartment or group of compartments under consideration coincides with the aft terminal or the forward limit of the compartment or group of compartments under consideration coincides with the forward terminal:

$J \leq J_k$:

$$p(x_1, x_2) = \frac{1}{2} (p_1 + J)$$

$J > J_k$:

$$p(x_1, x_2) = \frac{1}{2} (p_2 + J)$$

1.1.3 Where the compartment or groups of compartments considered extends over the entire subdivision length (L_s):

$$p(x1, x2) = 1$$

1.2 The factor $r(x1, x2, b)$ shall be determined by the following formulae:

$$r(x1, x2, b) = 1 - (1 - C) \cdot \left[1 - \frac{G}{p(x1, x2)} \right]$$

where:

$$C = 12 \cdot J_b \cdot (-45 \cdot J_b + 4)$$

where:

$$J_b = \frac{b}{15 \cdot B}$$

1.2.1 Where the compartment or groups of compartments considered extends over the entire subdivision length (L_s):

$$G = G_1 = \frac{1}{2} b_{11} J_b^2 + b_{12} J_b$$

1.2.2 Where neither limits of the compartment or group of compartments under consideration coincides with the aft or forward terminals:

$$G = G_2 = -\frac{1}{3} b_{11} J_0^3 + \frac{1}{2} (b_{11} J - b_{12}) J_0^2 + b_{12} J J_0$$

where:

$$J_0 = \min (J, J_b)$$

1.2.3 Where the aft limit of the compartment or group of compartments under consideration coincides with the aft terminal or the forward limit of the compartment or group of compartments under consideration coincides with the forward terminal:

$$G = \frac{1}{2} \cdot (G_2 + G_1 \cdot J)$$

Regulation 7-2 – Calculation of the factor s_i

1. The factor s_i shall be determined for each case of assumed flooding, involving a compartment or group of compartments, in accordance with the following notations and the provisions in this regulation.

θ_e is the equilibrium heel angle in any stage of flooding, in degrees;

θ_v is the angle, in any stage of flooding, where the righting lever becomes negative, or the angle at which an opening incapable of being closed weathertight becomes submerged;

GZ_{max} is the maximum positive righting lever, in metres, up to the angle θ_v ;

Range is the range of positive righting levers, in degrees, measured from the angle θ_e . The positive range is to be taken up to the angle θ_v ;

Flooding stage is any discrete step during the flooding process, including the stage before equalization (if any) until final equilibrium has been reached.

- 1.1. The factor s_i , for any damage case at any initial loading condition, d_i , shall be obtained from the formula:

$$s_i = \text{minimum} \{ s_{\text{intermediate},i} \text{ Or } s_{\text{final},i} \cdot s_{\text{mom},i} \}$$

where:

$s_{\text{intermediate},i}$ is the probability to survive all intermediate flooding stages until the final equilibrium stage, and is calculated in accordance with paragraph 2;

$s_{\text{final},i}$ is the probability to survive in the final equilibrium stage of flooding. It is calculated in accordance with paragraph 3;

$s_{\text{mom},i}$ is the probability to survive heeling moments, and is calculated in accordance with paragraph 4.

2. The factor $s_{\text{intermediate},i}$ is applicable only to passenger ships (for cargo ships $s_{\text{intermediate},i}$ should be taken as unity) and shall be taken as the least of the s-factors obtained from all flooding stages including the stage before equalization, if any, and is to be calculated as follows:

$$s_{\text{intermediate},i} = \left[\frac{GZ_{\text{max}}}{0.05} \cdot \frac{\text{Range}}{7} \right]^{\frac{1}{4}}$$

where GZ_{max} is not to be taken as more than 0.05 m and Range as not more than 7° . $s_{\text{intermediate}} = 0$, if the intermediate heel angle exceeds 15° . Where cross-flooding fittings are required, the time for equalization shall not exceed 10 min.

3. The factor $s_{\text{final},i}$ shall be obtained from the formula:

$$s_{\text{final},i} = \left[\frac{GZ_{\text{max}}}{0.12} \cdot \frac{\text{Range}}{16} \right]^{\frac{1}{4}}$$

where:

GZ_{max} is not to be taken as more than 0.12 m;

Range is not to be taken as more than 16°;

$$K = 1 \quad \text{if } \theta_e \leq \theta_{\text{min}}$$

$$K = 0 \quad \text{if } \theta_e \geq \theta_{\text{max}}$$

$$K = \sqrt{\frac{\theta_{\text{max}} - \theta_e}{\theta_{\text{max}} - \theta_{\text{min}}}} \text{ or,}$$

where:

θ_{min} is 7° for passenger ships and 25° for cargo ships;

and

θ_{max} is 15° for passenger ships and 30° for cargo ships.

4. The factor $s_{\text{mom},i}$ is applicable only to passenger ships (for cargo ships $s_{\text{mom},i}$ shall be taken as unity) and shall be calculated at the final equilibrium from the formula:

$$S_{\text{mom},i} = \frac{(GZ_{\text{max}} - 0.04) \cdot \text{Displacement}}{M_{\text{heel}}}$$

where:

Displacement is the intact displacement at the subdivision draught;

M_{heel} is the maximum assumed heeling moment as calculated in accordance with subparagraph 4.1; and

$$s_{\text{mom},i} \leq 1$$

- 4.1. The heeling moment M_{heel} is to be calculated as follows:

$$M_{\text{heel}} = \text{maximum} \{ M_{\text{passenger}} \text{ or } M_{\text{wind}} \text{ or } M_{\text{Survivalcraft}} \}$$

- 4.1.1. $M_{\text{passenger}}$ is the maximum assumed heeling moment resulting from movement of passengers, and is to be obtained as follows:

$$M_{\text{passenger}} = (0.075 \cdot N_p) \cdot (0.45 \cdot B) \text{ (tm)}$$

where:

N_p is the maximum number of passengers permitted to be on board in the service condition corresponding to the deepest subdivision draught under consideration; and

B is the beam of the ship.

Alternatively, the heeling moment may be calculated assuming the passengers are distributed with 4 persons per square metre on available deck areas towards one side of the ship on the decks where muster stations are located and in such a way that they produce the most adverse heeling moment. In doing so, a weight of 75 kg per passenger is to be assumed.

4.1.2. M_{wind} is the maximum assumed wind force acting in a damage situation:

$$M_{\text{wind}} = (P \cdot A \cdot Z) / 9,806 \text{ (tm)}$$

where:

$$P = 120 \text{ N/m}^2;$$

A = projected lateral area above waterline;

Z = distance from centre of lateral projected area above waterline to $T/2$;
and

T = ship's draught, d_i .

4.1.3. $M_{\text{Survivalcraft}}$ is the maximum assumed heeling moment due to the launching of all fully loaded davit-launched survival craft on one side of the ship. It shall be calculated using the following assumptions:

- 4.1.3.1. all lifeboats and rescue boats fitted on the side to which the ship has heeled after having sustained damage shall be assumed to be swung out fully loaded and ready for lowering;
- 4.1.3.2. for lifeboats which are arranged to be launched fully loaded from the stowed position, the maximum heeling moment during launching shall be taken;
- 4.1.3.3. a fully loaded davit-launched liferaft attached to each davit on the side to which the ship has heeled after having sustained damage shall be assumed to be swung out ready for lowering;
- 4.1.3.4. persons not in the life-saving appliances which are swung out shall not provide either additional heeling or righting moment;
and
- 4.1.3.5. life-saving appliances on the side of the ship opposite to the side to which the ship has heeled shall be assumed to be in a stowed position.

5. Unsymmetrical flooding is to be kept to a minimum consistent with the efficient arrangements. Where it is necessary to correct large angles of heel, the means adopted shall, where practicable, be self-acting, but in any case where controls to equalization devices are provided they shall be operable from above the bulkhead deck. These fittings together with their controls shall be acceptable to the Administration.⁴ Suitable information concerning the use of equalization devices shall be supplied to the master of the ship.
- 5.1. Tanks and compartments taking part in such equalization shall be fitted with air pipes or equivalent means of sufficient cross-section to ensure that the flow of water into the equalization compartments is not delayed.
 - 5.2. In all cases, s_i is to be taken as zero in those cases where the final waterline, taking into account sinkage, heel and trim, immerses:
 - 5.2.1. the lower edge of openings through which progressive flooding may take place and such flooding is not accounted for in the calculation of factor s_i . Such openings shall include air-pipes, ventilators and openings which are closed by means of weathertight doors or hatch covers; and
 - 5.2.2. any part of the bulkhead deck in passenger ships considered a horizontal evacuation route for compliance with chapter II-2.
 - 5.3. The factor s_i is to be taken as zero if, taking into account sinkage, heel and trim, any of the following occur in any intermediate stage or in the final stage of flooding:
 - 5.3.1. immersion of any vertical escape hatch in the bulkhead deck intended for compliance with chapter II-2;
 - 5.3.2. any controls intended for the operation of watertight doors, equalization devices, valves on piping or on ventilation ducts intended to maintain the integrity of watertight bulkheads from above the bulkhead deck become inaccessible or inoperable;
 - 5.3.3. immersion of any part of piping or ventilation ducts carried through a watertight boundary that is located within any compartment included in damage cases contributing to the attained index A , if not fitted with watertight means of closure at each boundary.
 - 5.4. However, where compartments assumed flooded due to progressive flooding are taken into account in the damage stability calculations multiple values of $s_{\text{intermediate},i}$ may be calculated assuming equalization in additional flooding phases.
 - 5.5. Except as provided in paragraph 5.3.1, openings closed by means of watertight manhole covers and flush scuttles, small watertight hatch covers, remotely operated sliding watertight doors, side scuttles of the non-opening type as well as watertight access doors and hatch covers required to be kept closed at sea need not be considered.
6. Where horizontal watertight boundaries are fitted above the waterline under consideration the s -value calculated for the lower compartment or group of compartments shall be obtained by multiplying the value as determined in paragraph 1.1 by the reduction factor v_m according to paragraph 6.1, which represents the probability that the spaces above the horizontal subdivision will not be flooded.
- 6.1. The factor v_m shall be obtained from the formula:

$$v_m = v(H_{j, n, m}, d) \cdot v(H_{j, n, m-1}, d)$$

⁴ Reference is made to the Recommendation on a standard method for establishing compliance with the requirements for cross-flooding arrangements in passenger ships, adopted by the Organization by resolution A.266(VIII), as may be amended.

where:

$H_{j, n, m}$ is the least height above the baseline, in metres, within the longitudinal range of $x_{1(j)} \dots x_{2(j+n-1)}$ of the m^{th} horizontal boundary which is assumed to limit the vertical extent of flooding for the damaged compartments under consideration;

j signifies the aft terminal of the damaged compartments under consideration;

m represents each horizontal boundary counted upwards from the waterline under consideration;

d is the draught in question as defined in regulation 2; and

x_1 and x_2 represent the terminals of the compartment or group of compartments considered in regulation 7-1.

6.1.1. The factors $v(H_{j, n, m}, d)$ and $v(H_{j, n, m-1}, d)$ shall be obtained from the formulas:

$$v(H, d) = 0.8 \frac{(H - d)}{7.8}$$

if $(H_m - d)$ is less than, or equal to, 7.8 m;

in all other cases,

$$v(H, d) = 0.8 + 0.2 \left[\frac{(H - d) - 7.8}{4.7} \right]$$

where:

$v(H_{j, n, m}, d)$ is to be taken as 1, if H_m coincides with the uppermost watertight boundary of the ship within the range $(x_{1(j)} \dots x_{2(j+n-1)})$, and

$v(H_{j, n, 0}, d)$ is to be taken as 0.

In no case is v_m to be taken as less than zero or more than 1.

6.2. In general, each contribution dA to the index A in the case of horizontal subdivisions is obtained from the formula:

$$dA = p_i \cdot [v_1 \cdot S_{\min 1} + (v_2 - v_1) \cdot S_{\min 2} + \dots + (1 - v_{m-1}) \cdot S_{\min m}]$$

where:

v_m = the v -value calculated in accordance with paragraph 6.1;

s_{\min} = the least s -factor for all combinations of damages obtained when the assumed damage extends from the assumed damage height H_m downwards.

Regulation 7-3 – Permeability

1. For the purpose of the subdivision and damage stability calculations of the regulations, the permeability of each general compartment or part of a compartment shall be as follows:

Spaces	Permeability
Appropriated to stores	0.60
Occupied by accommodation	0.95
Occupied by machinery	0.85
Void spaces	0.95
Intended for liquids	0 or 0.951 ^{*)}

^{*)} Whichever results in the more severe requirement.

2. For the purpose of the subdivision and damage stability calculations of the regulations, the permeability of each cargo compartment or part of a compartment shall be as follows:

Spaces	Permeability at draught d_s	Permeability at draught d_p	Permeability at draught d_1
Dry cargo spaces	0.70	0.80	0.95
Container spaces	0.70	0.80	0.95
Ro-ro spaces	0.90	0.90	0.95
Cargo liquids	0.70	0.80	0.95

3. Other figures for permeability may be used if substantiated by calculations.

Regulation 8 – Special requirements concerning passenger ship stability

- 1 A passenger ship intended to carry 400 or more persons shall have watertight subdivision abaft the collision bulkhead so that $s_i = 1$ for the three loading conditions on which is based the calculation of the subdivision index and for a damage involving all the compartments within $0.08L$ measured from the forward perpendicular.
- 2 A passenger ship intended to carry 36 or more persons is to be capable of withstanding damage along the side shell to an extent specified in paragraph 3. Compliance with this regulation is to be achieved by demonstrating that s_i , as defined in regulation 7-2, is not less than 0.9 for the three loading conditions on which is based the calculation of the subdivision index.
- 3 The damage extent to be assumed when demonstrating compliance with paragraph 2, is to be dependent on both N as defined in regulation 6, and L_s as defined in regulation 2, such that:
 - 3.1 the vertical extent of damage is to extend from the ship's moulded baseline to a position up to 12.5 m above the position of the deepest subdivision draught as defined in regulation 2, unless a lesser vertical extent of damage were to give a lower value of s_i , in which case this reduced extent is to be used;
 - 3.2 where 400 or more persons are to be carried, a damage length of $0.03L_s$ but not less than 3 m is to be assumed at any position along the side shell, in conjunction with a penetration inboard of $0.1B$ but not less than 0.75 m measured inboard from the ship side, at right angle to the centreline at the level of the deepest subdivision draught;
 - 3.3 where less than 400 persons are carried, damage length is to be assumed at any position along the shell side between transverse watertight bulkheads provided that the distance

between two adjacent transverse watertight bulkheads is not less than the assumed damage length. If the distance between adjacent transverse watertight bulkheads is less than the assumed damage length, only one of these bulkheads shall be considered effective for the purpose of demonstrating compliance with paragraph 2;

- 3.4 where 36 persons are carried, a damage length of $0.015L_s$ but not less than 3 m is to be assumed, in conjunction with a penetration inboard of $0.05B$ but not less than 0.75 m; and
- 3.5 where more than 36, but fewer than 400 persons are carried the values of damage length and penetration inboard, used in the determination of the assumed extent of damage, are to be obtained by linear interpolation between the values of damage length and penetration which apply for ships carrying 36 persons and 400 persons as specified in subparagraphs .4 and .2.

Regulation 8-1 – System capabilities after a flooding casualty on passenger ships

1 Application

This regulation applies to passenger ships constructed on or after 1 July 2010 to which regulation II-2/21 applies.

2 Availability of essential systems in case of flooding damage.⁵

A passenger ship shall be designed so that the systems specified in regulation II-2/21.4 remain operational when the ship is subject to flooding of any single watertight compartment.

⁵ Refer to the Performance standards for the systems and services to remain operational on passenger ships for safe return to port and orderly evacuation and abandonment after a casualty (MSC.1/Circ.1214).

**Notice from the Danish Maritime Authority B –
The Construction and Equipment, etc. of Ships**

Chapter B II-1 B-2

Construction – Structure, subdivision and stability, machinery and electrical installations

Regulation 9 – Double bottoms in passenger ships and cargo ships other than tankers.....	1
Regulation 10 – Construction of watertight bulkheads.....	2
Regulation 11 – Initial testing of watertight bulkheads, etc.	3
Regulation 12 – Peak and machinery space bulkheads, shaft tunnels, etc.....	3
Regulation 13 – Openings in watertight bulkheads below the bulkhead deck in passenger ships ..	4
Regulation 13-1 – Openings in watertight bulkheads and internal decks in cargo ships.....	9
Regulation 14 – Passenger ships carrying goods vehicles and accompanying personnel	9
Regulation 15 – Openings in the shell plating below the bulkhead deck of passenger ships and the freeboard deck of cargo ships	10
Regulation 15-1 – External openings in cargo ships.....	11
Regulation 16 – Construction and initial tests of watertight doors, sidescuttles, etc.....	11
Regulation 16-1 – Construction and initial tests of watertight decks, trunks, etc.....	12
Regulation 17 – Internal watertight integrity of passenger ships above the bulkhead deck.....	12
Regulation 17-1 – Integrity of the hull and superstructure, damage prevention and control on ro-ro passenger ships	13

PART B-2 – Subdivision, watertight and weathertight integrity

Regulation 9 – Double bottoms in passenger ships and cargo ships other than tankers

- 1 A double bottom shall be fitted extending from the collision bulkhead to the afterpeak bulkhead, as far as this is practicable and compatible with the design and proper working of the ship.
- 2 Where a double bottom is required to be fitted the inner bottom shall be continued out to the ship's sides in such a manner as to protect the bottom to the turn of the bilge. Such protection will be deemed satisfactory if the inner bottom is not lower at any part than a plane parallel with the keel line and which is located not less than a vertical distance h measured from the keel line, as calculated by the formula:

$$h = B/20$$

However, in no case is the value of h to be less than 760 mm, and need not be taken as more than 2,000 mm.

- 3 Small wells constructed in the double bottom in connection with drainage arrangements of holds, etc., shall not extend downward more than necessary. A well extending to the outer

bottom is, however, permitted at the after end of the shaft tunnel. Other wells (e.g. for lubricating oil under main engines) may be permitted by the Administration if satisfied that the arrangements give protection equivalent to that afforded by a double bottom complying with this regulation. In no case shall the vertical distance from the bottom of such a well to a plane coinciding with the keel line be less than 500 mm.

- 4 A double bottom need not be fitted in way of watertight tanks, including dry tanks of moderate size, provided the safety of the ship is not impaired in the event of bottom or side damage.
- 5 In the case of ships to which the provisions of regulation 1.5 apply and which are engaged on regular service within the limits of a short international voyage as defined in regulation III/3.22, the Administration may permit a double bottom to be dispensed with if satisfied that the fitting of a double bottom in that part would not be compatible with the design and proper working of the ship.
- 6 Any part of a passenger ship or a cargo ship that is not fitted with a double bottom in accordance with paragraphs 1, 4 or 5 shall be capable of withstanding bottom damages, as specified in paragraph 8, in that part of the ship.
- 7 In the case of unusual bottom arrangements in a passenger ship, it shall be demonstrated that the ship is capable of withstanding bottom damages as specified in paragraph 8.
- 8 Compliance with paragraphs 6 or 7 is to be achieved by demonstrating that *si*, when calculated in accordance with regulation 7-2, is not less than 1 for all service conditions when subject to a bottom damage assumed at any position along the ship's bottom and with an extent specified in .2 below for the affected part of the ship:
 - 8.1 Flooding of such spaces shall not render emergency power and lighting, internal communication, signals or other emergency devices inoperable in other parts of the ship.
 - 8.2 Assumed extent of damage shall be as follows:

	For 0.3 L from the forward perpendicular of the ship	Any other part of the ship
Longitudinal extent	$1/3 L^{2/3}$ or 14.5 m, whichever is less	$1/3 L^{2/3}$ or 14.5 m, whichever is less
Transverse extent	$B/6$ or 10 m, whichever is less	$B/6$ or 5 m, whichever is less
Vertical extent, measured from the keel line	$B/20$ or 2 m, whichever is less	$B/20$ or 2 m, whichever is less

8.3 If any damage of a lesser extent than the maximum damage specified in .2 would result in a more severe condition, such damage should be considered.

- 9 In case of large lower holds in passenger ships, the Administration may require an increased double bottom height of not more than $B/10$ or 3 m, whichever is less, measured from the keel line. Alternatively, bottom damages may be calculated for these areas, in accordance with paragraph 8, but assuming an increased vertical extent.

Regulation 10 – Construction of watertight bulkheads

- 1 Each watertight subdivision bulkhead, whether transverse or longitudinal, shall be constructed having scantlings as specified in regulation 2.17. In all cases, watertight subdivision bulkheads shall be capable of supporting at least the pressure due to a head of water up to the bulkhead deck.
- 2 Steps and recesses in watertight bulkheads shall be as strong as the bulkhead at the place where each occurs.

Regulation 11 – Initial testing of watertight bulkheads, etc.

- 1 Testing watertight spaces not intended to hold liquids and cargo holds intended to hold ballast by filling them with water is not compulsory. When testing by filling with water is not carried out, a hose test shall be carried out where practicable. This test shall be carried out in the most advanced stage of the fitting out of the ship. Where a hose test is not practicable because of possible damage to machinery, electrical equipment insulation or outfitting items, it may be replaced by a careful visual examination of welded connections, supported where deemed necessary by means such as a dye penetrant test or an ultrasonic leak test or an equivalent test. In any case a thorough inspection of the watertight bulkheads shall be carried out.
- 2 The forepeak, double bottom (including duct keels) and inner skins shall be tested with water to a head corresponding to the requirements of regulation 10.1.
- 3 Tanks which are intended to hold liquids, and which form part of the watertight subdivision of the ship, shall be tested for tightness and structural strength with water to a head corresponding to its design pressure. The water head is in no case to be less than the top of the air pipes or to a level of 2.4 m above the top of the tank, whichever is the greater.
- 4 The tests referred to in paragraphs 2 and 3 are for the purpose of ensuring that the subdivision structural arrangements are watertight and are not to be regarded as a test of the fitness of any compartment for the storage of oil fuel or for other special purposes for which a test of a superior character may be required depending on the height to which the liquid has access in the tank or its connections.

Regulation 12 – Peak and machinery space bulkheads, shaft tunnels, etc.

- 1 A collision bulkhead shall be fitted which shall be watertight up to the bulkhead deck. This bulkhead shall be located at a distance from the forward perpendicular of not less than $0.05L$ or 10 m, whichever is the less, and, except as may be permitted by the Administration, not more than $0.08L$ or $0.05L + 3$ m, whichever is the greater.
- 2 Where any part of the ship below the waterline extends forward of the forward perpendicular, e.g. a bulbous bow, the distances stipulated in paragraph 2 shall be measured from a point either:
 - 2.1 at the mid-length of such extension;
 - 2.2 at a distance $0.015L$ forward of the forward perpendicular; or
 - 2.3 at a distance 3 m forward of the forward perpendicular, whichever gives the smallest measurement.
- 3 The bulkhead may have steps or recesses provided they are within the limits prescribed in paragraph 1 or 2.
- 4 No doors, manholes, access openings, ventilation ducts or any other openings shall be fitted in the collision bulkhead below the bulkhead deck.
- 5
 - 5.1 Except as provided in paragraph 5.2, the collision bulkhead may be pierced below the bulkhead deck by not more than one pipe for dealing with fluid in the forepeak tank, provided that the pipe is fitted with a screw-down valve capable of being operated from above the bulkhead deck, the valve chest being secured inside the forepeak to the collision bulkhead. The Administration may, however, authorize the fitting of this valve on the after side of the collision bulkhead provided that the valve is readily accessible under all service conditions and the space in which it is located is not a cargo space. All valves shall be of steel, bronze or other approved ductile material. Valves of ordinary cast iron or similar material are not acceptable.
 - 5.2 If the forepeak is divided to hold two different kinds of liquids the Administration may allow the collision bulkhead to be pierced below the bulkhead by two pipes, each of

which is fitted as required by paragraph 5.1, provided the Administration is satisfied that there is no practical alternative to the fitting of such a second pipe and that, having regard to the additional subdivision provided in the forepeak, the safety of the ship is maintained.

- 6 Where a long forward superstructure is fitted the collision bulkhead shall be extended weathertight to the deck next above the bulkhead deck. The extension need not be fitted directly above the bulkhead below provided it is located within the limits prescribed in paragraph 1 or 2 with the exception permitted by paragraph 7 and that the part of the deck which forms the step is made effectively weathertight. The extension shall be so arranged as to preclude the possibility of the bow door causing damage to it in the case of damage to, or detachment of, a bow door.
- 7 Where bow doors are fitted and a sloping loading ramp forms part of the extension of the collision bulkhead above the bulkhead deck the ramp shall be weathertight over its complete length. In cargo ships the part of the ramp which is more than 2.3 m above the bulkhead deck may extend forward of the limit specified in paragraph 1 or 2. Ramps not meeting the above requirements shall be disregarded as an extension of the collision bulkhead.
- 8 The number of openings in the extension of the collision bulkhead above the freeboard deck shall be restricted to the minimum compatible with the design and normal operation of the ship. All such openings shall be capable of being closed weathertight.
- 9 Bulkheads shall be fitted separating the machinery space from cargo and accommodation spaces forward and aft and made watertight up to the bulkhead deck. In passenger ships an afterpeak bulkhead shall also be fitted and made watertight up to the bulkhead deck. The afterpeak bulkhead may, however, be stepped below the bulkhead deck, provided the degree of safety of the ship as regards subdivision is not thereby diminished.
- 10 In all cases stern tubes shall be enclosed in watertight spaces of moderate volume. In passenger ships the stern gland shall be situated in a watertight shaft tunnel or other watertight space separate from the stern tube compartment and of such volume that, if flooded by leakage through the stern gland, the bulkhead deck will not be immersed. In cargo ships other measures to minimize the danger of water penetrating into the ship in case of damage to stern tube arrangements may be taken at the discretion of the Administration.

Regulation 13 – Openings in watertight bulkheads below the bulkhead deck in passenger ships

- 1 The number of openings in watertight bulkheads shall be reduced to the minimum compatible with the design and proper working of the ship, satisfactory means shall be provided for closing these openings.
- 2
 - 2.1 Where pipes, scuppers, electric cables, etc., are carried through watertight bulkheads, arrangements shall be made to ensure the watertight integrity of the bulkheads.
 - 2.2 Valves not forming part of a piping system shall not be permitted in watertight bulkheads.
 - 2.3 Lead or other heat sensitive materials shall not be used in systems which penetrate watertight bulkheads, where deterioration of such systems in the event of fire would impair the watertight integrity of the bulkheads.
- 3 No doors, manholes, or access openings are permitted in watertight transverse bulkheads dividing a cargo space from an adjoining cargo space, except as provided in paragraph 9.1 and in regulation 14.
- 4 Subject to paragraph 10, not more than one door, apart from the doors to shaft tunnels, may be fitted in each watertight bulkhead within spaces containing the main and auxiliary propulsion

machinery including boilers serving the needs of propulsion. Where two or more shafts are fitted, the tunnels shall be connected by an intercommunicating passage. There shall be only one door between the machinery space and the tunnel spaces where two shafts are fitted and only two doors where there are more than two shafts. All these doors shall be of the sliding type and shall be so located as to have their sills as high as practicable. The hand gear for operating these doors from above the bulkhead deck shall be situated outside the spaces containing the machinery.

5

5.1 Watertight doors, except as provided in paragraph 9.1 or regulation 14, shall be power-operated sliding doors complying with the requirements of paragraph 7 capable of being closed simultaneously from the central operating console at the navigation bridge in not more than 60 s with the ship in the upright position.

5.2 The means of operation whether by power or by hand of any power-operated sliding watertight door shall be capable of closing the door with the ship listed to 15° either way. Consideration shall also be given to the forces which may act on either side of the door as may be experienced when water is flowing through the opening applying a static head equivalent to a water height of at least 1 m above the sill on the centreline of the door.

5.3 Watertight door controls, including hydraulic piping and electric cables, shall be kept as close as practicable to the bulkhead in which the doors are fitted, in order to minimize the likelihood of them being involved in any damage which the ship may sustain. The positioning of watertight doors and their controls shall be such that if the ship sustains damage within one fifth of the breadth of the ship, as defined in regulation 2, such distance being measured at right angles to the centreline at the level of the deepest subdivision draught, the operation of the watertight doors clear of the damaged portion of the ship is not impaired.

6 All power-operated sliding watertight doors shall be provided with means of indication which will show at all remote operating positions whether the doors are open or closed. Remote operating positions shall only be at the navigation bridge as required by paragraph 7.1.5 and at the location where hand operation above the bulkhead deck is required by paragraph 7.1.4.

7

7.1 Each power-operated sliding watertight door:

7.1.1 shall have a vertical or horizontal motion;

7.1.2 shall, subject to paragraph 10, be normally limited to a maximum clear opening width of 1.2 m. The Administration may permit larger doors only to the extent considered necessary for the effective operation of the ship provided that other safety measures, including the following, are taken into consideration:

7.1.2.1 special consideration shall be given to the strength of the door and its closing appliances in order to prevent leakages; and

7.1.2.2 the door shall be located inboard the damage zone $B/5$;

7.1.3 shall be fitted with the necessary equipment to open and close the door using electric power, hydraulic power, or any other form of power that is acceptable to the Administration;

7.1.4 shall be provided with an individual hand-operated mechanism. It shall be possible to open and close the door by hand at the door itself from either side, and in addition, close the door from an accessible position above the bulkhead deck with an all round crank motion or some other movement providing the same degree of safety acceptable to the Administration. Direction of rotation or other movement is to be clearly indicated at all operating positions. The time necessary

- for the complete closure of the door, when operating by hand gear, shall not exceed 90 s with the ship in the upright position;
- 7.1.5 shall be provided with controls for opening and closing the door by power from both sides of the door and also for closing the door by power from the central operating console at the navigation bridge;
 - 7.1.6 shall be provided with an audible alarm, distinct from any other alarm in the area, which will sound whenever the door is closed remotely by power and which shall sound for at least 5 s but no more than 10 s before the door begins to move and shall continue sounding until the door is completely closed. In the case of remote hand operation it is sufficient for the audible alarm to sound only when the door is moving. Additionally, in passenger areas and areas of high ambient noise the Administration may require the audible alarm to be supplemented by an intermittent visual signal at the door; and
 - 7.1.7 shall have an approximately uniform rate of closure under power. The closure time, from the time the door begins to move to the time it reaches the completely closed position, shall in no case be less than 20 s or more than 40 s with the ship in the upright position.
- 7.2 The electrical power required for power-operated sliding watertight doors shall be supplied from the emergency switchboard either directly or by a dedicated distribution board situated above the bulkhead deck. The associated control, indication and alarm circuits shall be supplied from the emergency switchboard either directly or by a dedicated distribution board situated above the bulkhead deck and be capable of being automatically supplied by the transitional source of emergency electrical power required by regulation 42.3.1.3 in the event of failure of either the main or emergency source of electrical power.
- 7.3 Power-operated sliding watertight doors shall have either:
- 7.3.1 a centralized hydraulic system with two independent power sources each consisting of a motor and pump capable of simultaneously closing all doors. In addition, there shall be for the whole installation hydraulic accumulators of sufficient capacity to operate all the doors at least three times, i.e. closed-open-closed, against an adverse list of 15°. This operating cycle shall be capable of being carried out when the accumulator is at the pump cut-in pressure. The fluid used shall be chosen considering the temperatures liable to be encountered by the installation during its service. The power operating system shall be designed to minimize the possibility of having a single failure in the hydraulic piping adversely affect the operation of more than one door. The hydraulic system shall be provided with a low-level alarm for hydraulic fluid reservoirs serving the power-operated system and a low gas pressure alarm or other effective means of monitoring loss of stored energy in hydraulic accumulators. These alarms are to be audible and visual and shall be situated on the central operating console at the navigation bridge; or
 - 7.3.2 an independent hydraulic system for each door with each power source consisting of a motor and pump capable of opening and closing the door. In addition, there shall be a hydraulic accumulator of sufficient capacity to operate the door at least three times, i.e. closed-open-closed, against an adverse list of 15°. This operating cycle shall be capable of being carried out when the accumulator is at the pump cut-in pressure. The fluid used shall be chosen considering the temperatures liable to be encountered by the installation during its service. A low gas pressure group

alarm or other effective means of monitoring loss of stored energy in hydraulic accumulators shall be provided at the central operating console on the navigation bridge. Loss of stored energy indication at each local operating position shall also be provided; or

- 7.3.3 an independent electrical system and motor for each door with each power source consisting of a motor capable of opening and closing the door. The power source shall be capable of being automatically supplied by the transitional source of emergency electrical power as required by regulation 42.4.2 – in the event of failure of either the main or emergency source of electrical power and with sufficient capacity to operate the door at least three times, i.e. closed-open-closed, against an adverse list of 15 . For the systems specified in paragraphs 7.3.1, 7.3.2 and 7.3.3, provision should be made as follows: Power systems for power-operated watertight sliding doors shall be separate from any other power system. A single failure in the electric or hydraulic power-operated systems excluding the hydraulic actuator shall not prevent the hand operation of any door.
- 7.4 Control handles shall be provided at each side of the bulkhead at a minimum height of 1.6 m above the floor and shall be so arranged as to enable persons passing through the doorway to hold both handles in the open position without being able to set the power closing mechanism in operation accidentally. The direction of movement of the handles in opening and closing the door shall be in the direction of door movement and shall be clearly indicated.
- 7.5 As far as practicable, electrical equipment and components for watertight doors shall be situated above the bulkhead deck and outside hazardous areas and spaces.
- 7.6 The enclosures of electrical components necessarily situated below the bulkhead deck shall provide suitable protection against the ingress of water.¹
- 7.7 Electric power, control, indication and alarm circuits shall be protected against fault in such a way that a failure in one door circuit will not cause a failure in any other door circuit. Short circuits or other faults in the alarm or indicator circuits of a door shall not result in a loss of power operation of that door. Arrangements shall be such that leakage of water into the electrical equipment located below the bulkhead deck will not cause the door to open.
- 7.8 A single electrical failure in the power operating or control system of a power-operated sliding watertight door shall not result in a closed door opening. Availability of the power supply should be continuously monitored at a point in the electrical circuit as near as practicable to each of the motors required by paragraph 7.3. Loss of any such power supply should activate an audible and visual alarm at the central operating console at the navigation bridge.

8

- 8.1 The central operating console at the navigation bridge shall have a master mode switch with two modes of control: a local control mode which shall allow any door to be locally opened and locally closed after use without automatic closure, and a doors closed mode

¹ Refer to the following IEC publication 529, 1976:

.1 electrical motors, associated circuits and control components; protected to IPX 7 standard;
.2 door position indicators and associated circuit components; protected to IPX 8 standard; and
.3 door movement warning signals; protected to IPX 6 standard.

Other arrangements for the enclosures of electrical components may be fitted provided the Administration is satisfied that an equivalent protection is achieved. The water pressure IPX 8 shall be based on the pressure that may occur at the location of the component during flooding for a period of 36 h.

which shall automatically close any door that is open. The doors closed mode shall automatically close any door that is open. The doors closed mode shall permit doors to be opened locally and shall automatically re-close the doors upon release of the local control mechanism. The master mode switch shall normally be in the local control mode. The doors closed mode shall only be used in an emergency or for testing purposes. Special consideration shall be given to the reliability of the master mode switch.

8.2 The central operating console at the navigation bridge shall be provided with a diagram showing the location of each door, with visual indicators to show whether each door is open or closed. A red light shall indicate a door is fully open and a green light shall indicate a door is fully closed. When the door is closed remotely the red light shall indicate the intermediate position by flashing. The indicating circuit shall be independent of the control circuit for each door.

8.3 It shall not be possible to remotely open any door from the central operating console.

9

9.1 If the Administration is satisfied that such doors are essential, watertight doors of satisfactory construction may be fitted in watertight bulkheads dividing cargo between deck spaces. Such doors may be hinged, rolling or sliding doors but shall not be remotely controlled. They shall be fitted at the highest level and as far from the shell plating as practicable, but in no case shall the outboard vertical edges be situated at a distance from the shell plating which is less than one fifth of the breadth of the ship, as defined in regulation 2, such distance being measured at right angles to the centreline at the level of the deepest subdivision draught.

9.2 Should any such doors be accessible during the voyage, they shall be fitted with a device which prevents unauthorized opening. When it is proposed to fit such doors, the number and arrangements shall receive the special consideration of the Administration.

10 Portable plates on bulkheads shall not be permitted except in machinery spaces. The Administration may permit not more than one power-operated sliding watertight door in each watertight bulkhead larger than those specified in paragraph 7.1.2 to be substituted for these portable plates, provided these doors are intended to remain closed during navigation except in case of urgent necessity at the discretion of the master. These doors need not meet the requirements of paragraph 7.1.4 regarding complete closure by hand-operated gear in 90 s.

11

11.1 Where trunkways or tunnels for access from crew accommodation to the stokehold, for piping, or for any other purpose are carried through watertight bulkheads, they shall be watertight and in accordance with the requirements of regulation 16-1. The access to at least one end of each such tunnel or trunkway, if used as a passage at sea, shall be through a trunk extending watertight to a height sufficient to permit access above the bulkhead deck. The access to the other end of the trunkway or tunnel may be through a watertight door of the type required by its location in the ship. Such trunkways or tunnels shall not extend through the first subdivision bulkhead abaft the collision bulkhead.

11.2 Where it is proposed to fit tunnels piercing watertight bulkheads, these shall receive the special consideration of the Administration.

11.3 Where trunkways in connection with refrigerated cargo and ventilation or forced draught trunks are carried through more than one watertight bulkhead, the means of closure at such openings shall be operated by power and be capable of being closed from a central position situated above the bulkhead deck.

Regulation 13-1 – Openings in watertight bulkheads and internal decks in cargo ships

- 1 The number of openings in watertight subdivisions is to be kept to a minimum compatible with the design and proper working of the ship. Where penetrations of watertight bulkheads and internal decks are necessary for access, piping, ventilation, electrical cables, etc., arrangements are to be made to maintain the watertight integrity. The Administration may permit relaxation in the watertightness of openings above the freeboard deck, provided that it is demonstrated that any progressive flooding can be easily controlled and that the safety of the ship is not impaired.
- 2 Doors provided to ensure the watertight integrity of internal openings which are used while at sea are to be sliding watertight doors capable of being remotely closed from the bridge and are also to be operable locally from each side of the bulkhead. Indicators are to be provided at the control position showing whether the doors are open or closed, and an audible alarm is to be provided at the door closure. The power, control and indicators are to be operable in the event of main power failure. Particular attention is to be paid to minimizing the effect of control system failure. Each power-operated sliding watertight door shall be provided with an individual hand-operated mechanism. It shall be possible to open and close the door by hand at the door itself from both sides.
- 3 Access doors and access hatch covers normally closed at sea, intended to ensure the watertight integrity of internal openings, shall be provided with means of indication locally and on the bridge showing whether these doors or hatch covers are open or closed. A notice is to be affixed to each such door or hatch cover to the effect that it is not to be left open.
- 4 Watertight doors or ramps of satisfactory construction may be fitted to internally subdivide large cargo spaces, provided that the Administration is satisfied that such doors or ramps are essential. These doors or ramps may be hinged, rolling or sliding doors or ramps, but shall not be remotely controlled.² Should any of the doors or ramps be accessible during the voyage, they shall be fitted with a device which prevents unauthorized opening.
- 5 Other closing appliances which are kept permanently closed at sea to ensure the watertight integrity of internal openings shall be provided with a notice which is to be affixed to each such closing appliance to the effect that it is to be kept closed. Manholes fitted with closely bolted covers need not be so marked.

Regulation 14 – Passenger ships carrying goods vehicles and accompanying personnel

- 1 This regulation applies to passenger ships designed or adapted for the carriage of goods vehicles and accompanying personnel.
- 2 If in such a ship the total number of passengers which include personnel accompanying vehicles does not exceed $12 + Ad/25$, where Ad = total deck area (square metres) of spaces available for the stowage of goods vehicles and where the clear height at the stowage position and at the entrance to such spaces is not less than 4 m, the provisions of regulations 13.9.1 and 13.9.2 in respect of watertight doors apply except that the doors may be fitted at any level in watertight bulkheads dividing cargo spaces. Additionally, indicators are required on the navigation bridge to show automatically when each door is closed and all door fastenings are secured.
- 3 The ship may not be certified for a higher number of passengers than assumed in paragraph 2, if a watertight door has been fitted in accordance with this regulation.

² Refer to Interpretations of regulations of part B-1 of SOLAS chapter II-1 (MSC/Circ.651).

Regulation 15 – Openings in the shell plating below the bulkhead deck of passenger ships and the freeboard deck of cargo ships

- 1 The number of openings in the shell plating shall be reduced to the minimum compatible with the design and proper working of the ship.
- 2 The arrangement and efficiency of the means for closing any opening in the shell plating shall be consistent with its intended purpose and the position in which it is fitted and generally to the satisfaction of the Administration.
- 3
 - 3.1 Subject to the requirements of the International Convention on Load Lines in force, no sidescuttle shall be fitted in such a position that its sill is below a line drawn parallel to the bulkhead deck at side and having its lowest point 2.5% of the breadth of the ship above the deepest subdivision draught, or 500 mm, whichever is the greater.
 - 3.2 All sidescuttles the sills of which are below the bulkhead deck of passenger ships and the freeboard deck of cargo ships, as permitted by paragraph 3.1, shall be of such construction as will effectively prevent any person opening them without the consent of the master of the ship.
- 4 Efficient hinged inside deadlights so arranged that they can be easily and effectively closed and secured watertight, shall be fitted to all sidescuttles except that abaft one eighth of the ship's length from the forward perpendicular and above a line drawn parallel to the bulkhead deck at side and having its lowest point at a height of 3.7 m plus 2.5% of the breadth of the ship above the deepest subdivision draught, the deadlights may be portable in passenger accommodation other than that for steerage passengers, unless the deadlights are required by the International Convention on Load Lines in force to be permanently attached in their proper positions. Such portable deadlights shall be stowed adjacent to the sidescuttles they serve.
- 5
 - 5.1 No sidescuttles shall be fitted in any spaces which are appropriated exclusively to the carriage of cargo or coal.
 - 5.2 Sidescuttles may, however, be fitted in spaces appropriated alternatively to the carriage of cargo or passengers, but they shall be of such construction as will effectively prevent any person opening them or their deadlights without the consent of the master.
- 6 Automatic ventilating sidescuttles shall not be fitted in the shell plating below the bulkhead deck of passenger ships and the freeboard deck of cargo ships without the special sanction of the Administration.
- 7 The number of scuppers, sanitary discharges and other similar openings in the shell plating shall be reduced to the minimum either by making each discharge serve for as many as possible of the sanitary and other pipes, or in any other satisfactory manner.
- 8
 - 8.1 All inlets and discharges in the shell plating shall be fitted with efficient and accessible arrangements for preventing the accidental admission of water into the ship.
 - 8.2
 - 8.2.1 Subject to the requirements of the International Convention on Load Lines in force, and except as provided in paragraph 8.3, each separate discharge led through the shell plating from spaces below the bulkhead deck of passenger ships and the freeboard deck of cargo ships shall be provided with either one automatic non-return valve fitted with a positive means of closing it from above the bulkhead deck or with two automatic non-return valves without positive means of closing, provided that the inboard valve is situated above the deepest subdivision draught and is always accessible for examination under service conditions. Where

a valve with positive means of closing is fitted, the operating position above the bulkhead deck shall always be readily accessible and means shall be provided for indicating whether the valve is open or closed.

- 8.2.2 The requirements of the International Convention on Load Lines in force shall apply to discharges led through the shell plating from spaces above the bulkhead deck of passenger ships and the freeboard deck of cargo ships.
- 8.2.3 Machinery space, main and auxiliary sea inlets and discharges in connection with the operation of machinery shall be fitted with readily accessible valves between the pipes and the shell plating or between the pipes and fabricated boxes attached to the shell plating. In manned machinery spaces the valves may be controlled locally and shall be provided with indicators showing whether they are open or closed.
- 8.2.4 Moving parts penetrating the shell plating below the deepest subdivision draught shall be fitted with a watertight sealing arrangement acceptable to the Administration. The inboard gland shall be located within a watertight space of such volume that, if flooded, the bulkhead deck will not be submerged. The Administration may require that if such compartment is flooded, essential or emergency power and lighting, internal communication, signals or other emergency devices must remain available in other parts of the ship.
- 8.2.5 All shell fittings and valves required by this regulation shall be of steel, bronze or other approved ductile material. Valves of ordinary cast iron or similar material are not acceptable. All pipes to which this regulation refers shall be of steel or other equivalent material to the satisfaction of the Administration.

9 Gangway, cargo and fuelling ports fitted below the bulkhead deck of passenger ships and the freeboard deck of cargo ships shall be watertight and in no case be so fitted as to have their lowest point below the deepest subdivision draught.

10

- 10.1 The inboard opening of each ash-chute, rubbish-chute, etc., shall be fitted with an efficient cover.
- 10.2 If the inboard opening is situated below the bulkhead deck of passenger ships and the freeboard deck of cargo ships, the cover shall be watertight and, in addition, an automatic non-return valve shall be fitted in the chute in an easily accessible position above the deepest subdivision draught.

Regulation 15-1 – External openings in cargo ships

- 1 All external openings leading to compartments assumed intact in the damage analysis, which are below the final damage waterline, are required to be watertight.
- 2 External openings required to be watertight in accordance with paragraph 1 shall, except for cargo hatch covers, be fitted with indicators on the bridge.
- 3 Openings in the shell plating below the deck limiting the vertical extent of damage shall be fitted with a device that prevents unauthorized opening if they are accessible during the voyage.
- 4 Other closing appliances which are kept permanently closed at sea to ensure the watertight integrity of external openings shall be provided with a notice affixed to each appliance to the effect that it is to be kept closed. Manholes fitted with closely bolted covers need not be so marked.

Regulation 16 – Construction and initial tests of watertight doors, sidescuttles, etc.

- 1 In all ships:

- 1.1 the design, materials and construction of all watertight doors, sidescuttles, gangway and cargo ports, valves, pipes, ash-chutes and rubbish-chutes referred to in these regulations shall be to the satisfaction of the Administration;
 - 1.2 such valves, doors and mechanisms shall be suitably marked to ensure that they may be properly used to provide maximum safety; and
 - 1.3 the frames of vertical watertight doors shall have no groove at the bottom in which dirt might lodge and prevent the door closing properly.
- 2 In passenger ships and cargo ships watertight doors shall be tested by water pressure to a head of water they might sustain in a final or intermediate stage of flooding. Where testing of individual doors is not carried out because of possible damage to insulation or outfitting items, testing of individual doors may be replaced by a prototype pressure test of each type and size of door with a test pressure corresponding at least to the head required for the intended location. The prototype test shall be carried out before the door is fitted. The installation method and procedure for fitting the door on board shall correspond to that of the prototype test. When fitted on board, each door shall be checked for proper seating between the bulkhead, the frame and the door.

Regulation 16-1 – Construction and initial tests of watertight decks, trunks, etc.

- 1 Watertight decks, trunks, tunnels, duct keels and ventilators shall be of the same strength as watertight bulkheads at corresponding levels. The means used for making them watertight, and the arrangements adopted for closing openings in them, shall be to the satisfaction of the Administration. Watertight ventilators and trunks shall be carried at least up to the bulkhead deck in passenger ships and up to the freeboard deck in cargo ships.
- 2 Where a ventilation trunk passing through a structure penetrates the bulkhead deck, the trunk shall be capable of withstanding the water pressure that may be present within the trunk, after having taken into account the maximum heel angle allowable during intermediate stages of flooding, in accordance with regulation 7-2.
- 3 Where all or part of the penetration of the bulkhead deck is on the main ro-ro deck, the trunk shall be capable of withstanding impact pressure due to internal water motions (sloshing) of water trapped on the ro-ro deck.
- 4 After completion, a hose or flooding test shall be applied to watertight decks and a hose test to watertight trunks, tunnels and ventilators.

Regulation 17 – Internal watertight integrity of passenger ships above the bulkhead deck

- 1 The Administration may require that all reasonable and practicable measures shall be taken to limit the entry and spread of water above the bulkhead deck. Such measures may include partial bulkheads or webs. When partial watertight bulkheads and webs are fitted on the bulkhead deck, above or in the immediate vicinity of watertight bulkheads, they shall have watertight shell and bulkhead deck connections so as to restrict the flow of water along the deck when the ship is in a heeled damaged condition. Where the partial watertight bulkhead does not line up with the bulkhead below, the bulkhead deck between shall be made effectively watertight.³ Where openings, pipes, scuppers, electric cables etc. are carried through the partial watertight bulkheads or decks within the immersed part of the bulkhead deck, arrangements shall be made to ensure the watertight integrity of the structure above the bulkhead deck.

³ Refer to the Guidance notes on the integrity of flooding boundaries above the bulkhead deck of passenger ships for proper application of regulations II-1/8 and 20, paragraph 1, of SOLAS 1974, as amended (MSC/Circ.541, as may be amended).

- 2 All openings in the exposed weather deck shall have coamings of ample height and strength and shall be provided with efficient means for expeditiously closing them weathertight. Freeing ports, open rails and scuppers shall be fitted as necessary for rapidly clearing the weather deck of water under all weather conditions.
- 3 The open end of air pipes terminating within a superstructure shall be at least 1 m above the waterline when the ship heels to an angle of 15°, or the maximum angle of heel during intermediate stages of flooding, as determined by direct calculation, whichever is the greater. Alternatively, air pipes from tanks other than oil tanks may discharge through the side of the superstructure. The provisions of this paragraph are without prejudice to the provisions of the International Convention on Load Lines in force.
- 4 Sidescuttles, gangway, cargo and fuelling ports and other means for closing openings in the shell plating above the bulkhead deck shall be of efficient design and construction and of sufficient strength having regard to the spaces in which they are fitted and their positions relative to the deepest subdivision draught.⁴
- 5 Efficient inside deadlights, so arranged that they can be easily and effectively closed and secured watertight, shall be provided for all sidescuttles to spaces below the first deck above the bulkhead deck.

Regulation 17-1 – Integrity of the hull and superstructure, damage prevention and control on ro-ro passenger ships

1

- 1.1 Subject to the provisions of paragraphs 1.2 and 1.3, all accesses that lead to spaces below the bulkhead deck shall have a lowest point which is not less than 2.5 m above the bulkhead deck.
- 1.2 Where vehicle ramps are installed to give access to spaces below the bulkhead deck, their openings shall be able to be closed weathertight to prevent ingress of water below, alarmed and indicated to the navigation bridge.
- 1.3 The Administration may permit the fitting of particular accesses to spaces below the bulkhead deck provided they are necessary for the essential working of the ship, e.g. the movement of machinery and stores, subject to such accesses being made watertight, alarmed and indicated on the navigation bridge.
- 2 Indicators shall be provided on the navigation bridge for all shell doors, loading doors and other closing appliances which, if left open or not properly secured, could, in the opinion of the Administration, lead to flooding of a special category space or ro-ro space. The indicator system shall be designed on the fail-safe principle and shall show by visual alarms if the door is not fully closed or if any of the securing arrangements are not in place and fully locked and by audible alarms if such door or closing appliances become open or the securing arrangements become unsecured. The indicator panel on the navigation bridge shall be equipped with a mode selection function "harbour/sea voyage" so arranged that an audible alarm is given on the navigation bridge if the ship leaves harbour with the bow doors, inner doors, stern ramp or any other side shell doors not closed or any closing device not in the correct position. The power supply for the indicator system shall be independent of the power supply for operating and securing the doors.
- 3 Television surveillance and a water leakage detection system shall be arranged to provide an indication to the navigation bridge and to the engine control station of any leakage through inner

⁴ Refer to the Recommendation on strength and security and locking arrangements of shell doors on ro-ro passenger ships, adopted by the Organization by resolution A.793(19).

and outer bow doors, stern doors or any other shell doors which could lead to flooding of special category spaces or ro-ro spaces.

**Notice from the Danish Maritime Authority B –
The Construction and Equipment, etc. of Ships**

Chapter B II-1 B-3

**Construction – Structure, subdivision and stability, machinery and electrical
installations**

PART B-3 – Subdivision load line assignment for passenger ships

Regulation 18 – Assigning, marking and recording of subdivision load lines for passenger ships

- 1 In order that the required degree of subdivision shall be maintained, a load line corresponding to the approved subdivision draught shall be assigned and marked on the ship's sides. A ship intended for alternating modes of operation may, if the owners desire, have one or more additional load lines assigned and marked to correspond with the subdivision draughts which the Administration may approve for the alternative service configurations. Each service configuration so approved shall comply with part B-1 of this chapter independently of the results obtained for other modes of operation.
- 2 The subdivision load lines assigned and marked shall be recorded in the Passenger Ship Safety Certificate, and shall be distinguished by the notation P1 for the principal passenger service configuration, and P2, P3, etc., for the alternative configurations. The principal passenger configuration shall be taken as the mode of operation in which the required subdivision index *R* will have the highest value.
- 3 The freeboard corresponding to each of these load lines shall be measured at the same position and from the same deck line as the freeboards determined in accordance with the International Convention on Load Lines in force.
- 4 The freeboard corresponding to each approved subdivision load line and the service configuration, for which it is approved, shall be clearly indicated on the Passenger Ship Safety Certificate.
- 5 In no case shall any subdivision load line mark be placed above the deepest load line in salt water as determined by the strength of the ship or the International Convention on Load Lines in force.
- 6 Whatever may be the position of the subdivision load line marks, a ship shall in no case be loaded so as to submerge the load line mark appropriate to the season and locality as determined in accordance with the International Convention on Load Lines in force.
- 7 A ship shall in no case be so loaded that when it is in salt water the subdivision load line mark appropriate to the particular voyage and service configuration is submerged.

**Notice from the Danish Maritime Authority B –
The Construction and Equipment, etc. of Ships**

Chapter B II-1 B-4

Construction – Structure, subdivision and stability, machinery and electrical installations

<i>Regulation 19-0 – Stability information for passenger ships and cargo ships</i>	1
Regulation 19 – Damage control information.....	2
Regulation 20 – Loading of passenger ships	2
Regulation 21 – Periodical operation and inspection of watertight doors, etc. in passenger ships .	3
Regulation 22 – Prevention and control of water ingress, etc.	3
Regulation 22-1 – Flooding detection systems for passenger ships carrying 36 or more persons constructed on or after 1 July 2010.....	5
Regulation 23 – Special requirements for ro-ro passenger ships.....	5
Regulation 24 – Prevention and control of water ingress, etc. in cargo ships	5
Regulation 25 – Water level detectors on single hold cargo ships other than bulk carriers	6

PART B-4 – Stability management

Regulation 19-0 – Stability information for passenger ships and cargo ships

- 1 *Ships the keels of which are laid or which are at a similar stage of construction on or after 1 April 1976 shall, regardless of their length, comply with the relevant provisions in the Code of Intact Stability, Res. A.749(18), as amended.¹*
 - 1.1 *The same shall apply to ships that are being altered if the alteration has considerable effect on the conditions of stability and to ships bought abroad if they are registered with the Ships Register or Danish International Ship Register.*
 - 1.2 *Ships the keels of which are laid or which were at a similar stage of construction before 1 July 1998 and all cargo ships with a gross tonnage below 500 shall, however, not be required to meet the weather criteria in regulation 3.2 of the code.*
 - 1.3 *The special stability criteria for container ships with a length of more than 100 m stipulated in regulation 4.9 of the code are not mandatory.*
 - 1.4 *If the existing stability information of the ship must be corrected in order to comply with this regulation, such corrected stability information shall be approved at the next renewal survey, at the latest.*
- 2 *Suction dredgers shall comply with the provisions of the code under general loading conditions and under the following special loading conditions:*

¹ *With regard to passenger ships the keels of which are laid or which are at a similar stage of construction before 1 April 1976, reference is also made to Technical Regulation no. 6 of 3 August 1995 on supplementary requirements for intact stability for existing passenger ships engaged on international voyages issued by the Danish Maritime Authority.*

- 2.1 *Light ship with stores and 10% bunker.*
- 2.2 *100% bunker, no cargo.*
- 2.3 *10% bunker, water in cargo hold to the widest level.*
- 2.4 *10% bunker, water to the upper edge of cargo hold.*
- 2.5 *10% bunker, 1/3 sand cargo, water to the upper edge of cargo hold.*
- 2.6 *10% bunker, 2/3 sand cargo, water to the upper edge of cargo hold.*
- 2.7 *10% bunker, cargo hold filled with sand.*
- 2.8 *70% bunker, cargo hold filled with sand.*
- 2.9 *In .3, .4, .5 and .6, correction shall be made for the effect of free surface water from water in the cargo hold.*
In dredging work where, for example, mud occurs, correction shall be made for the effect of full free surface from the load. The specific gravity for mud, etc. shall be set at 1.5.
The stability information for suction dredgers shall make the master of the ship aware that the sand cargo in rough weather shall be drained from the bottom.

Regulation 19 – Damage control information²

- 1 There shall be permanently exhibited, or readily available on the navigation bridge, for the guidance of the officer in charge of the ship, plans showing clearly for each deck and hold the boundaries of the watertight compartments, the openings therein with the means of closure and position of any controls thereof, and the arrangements for the correction of any list due to flooding. In addition, booklets containing the aforementioned information shall be made available to the officers of the ship.
- 2 Watertight doors in passenger ships permitted to remain open during navigation shall be clearly indicated in the ship's stability information
- 3 General precautions to be included shall consist of a listing of equipment, conditions, and operational procedures, considered by the Administration to be necessary to maintain watertight integrity under normal ship operations.
- 4 Specific precautions to be included shall consist of a listing of elements (i.e. closures, security of cargo, sounding of alarms, etc.) considered by the Administration to be vital to the survival of the ship, passengers and crew.
- 5 In case of ships to which damage stability requirements of part B-1 apply, damage stability information shall provide the master a simple and easily understandable way of assessing the ship's survivability in all damage cases involving a compartment or group of compartments.

Regulation 20 – Loading of passenger ships

- 1 On completion of loading of the ship and prior to its departure, the master shall determine the ship's trim and stability and also ascertain and record that the ship is in compliance with stability criteria in relevant regulations. The determination of the ship's stability shall always be made by calculation.³ The Administration may accept the use of an electronic loading and stability computer or equivalent means for this purpose.
- 2 Water ballast should not in general be carried in tanks intended for oil fuel. In ships in which it is not practicable to avoid putting water in oil fuel tanks, oily-water separating equipment to the satisfaction of the Administration shall be fitted, or other alternative means, such as discharge to

² Refer to the Guidelines for damage control plans (MSC/Circ.919). *Furthermore, reference is made to the most recent guidance on approval of ship stability issued by the Danish Maritime Authority.*

³ *For ships with frequent arrivals and departures, interpolation between a number of pre-calculated loading conditions, close to the actual one, may be equal to a direct calculation.*

***Notice from the Danish Maritime Authority B –
The Construction and Equipment, etc. of Ships
Chapter B II-1 B-5***

Introduction.....	1
Regulation 25-1 – Application.....	1
Regulation 25-2 – Definitions.....	2
Regulation 25-3 – General provisions	4
Regulation 25-4 – Specific stability requirements for ro-ro passenger ships	5
Regulation 25-5 – Model test method.....	8

Part B-5 Specific stability requirements for ro-ro passenger ships

Introduction

This part contains provisions that apply in pursuance of Directive 2003/25/EC of the European Parliament and of the Council of 14 April 2003 on specific stability requirements for ro-ro passenger ships, as amended.

Hence, the provisions of this part refers – as a consequence of the Directive – to the International Convention for the Safety of Life at Sea (SOLAS) 1974, as amended, and associated Protocols and Codes.

Attention is drawn to the fact that, in order to increase the readability, a reference has been inserted before the provisions referring to SOLAS 1974.

Regulation 25-1 – Application

- 1 This part shall apply to the following ro-ro passenger ships operating to and from a port of an EU member State on a regular service, regardless of their flag, when engaged on international voyages:
 - 1.1 New ro-ro passenger ships shall comply with the specific stability requirements of this part.*
 - 1.2 Existing ro-ro passenger ships, except for those operating exclusively in sea areas where the significant wave height is equal to or lower than 1.5 m and which comply with the requirements of SOLAS 74, chapter B II-1, regulation 8, shall comply with the specific stability requirements of this part no later than on 1 October 2010. Existing ro-ro passenger ships which complied with the requirements of SOLAS 74, chapter B II-1, regulation 8, on 17 May 2003 shall comply with the specific stability requirements of this part no later than on 1 October 2015.**

- 1.3 *This regulation shall be with prejudice to Article 4(1)(e) of Directive 1999/35/EC.¹*
- 1.4 *Each member State, in its capacity as host State, shall ensure that ro-ro passenger ships, flying the flag of a State which is not a member State, comply fully with the requirements of this Directive before they may be engaged on regular voyages from or to ports of that member State in accordance with Article 4 of Directive 1999/35/EC.*
- 2 *High-speed passenger craft as defined in regulation 1 of chapter X shall not be required to comply with the provisions of this part, provided that they comply entirely with the provisions of chapter X.*

Regulation 25-2 – Definitions

- 1 *For the purposes of this part, the following definitions shall apply:*
- 1.1 *“New ship” means a ship the keel of which is laid or which is at a similar stage of construction on or after 1 October 2004; a similar stage of construction means the stage at which:*
- 1.1.1 *construction identifiable with a specific ship begins; and*
- 1.1.2 *assembly of that ship has commenced comprising at least 50 tonnes or 1% of the estimated mass of structural material, whichever is less;*
- 1.2 *“An existing ship” means a ship which is not a new ship;*
- 1.3 *“International Conventions” means the 1974 International Convention for the Safety of Life at Sea (the SOLAS Convention), and the 1966 International Convention on Load Lines, together with Protocols and amendments thereto in force;*
- 1.4 *“Regular service” means a series of ro-ro passenger ship crossings serving traffic between the same two or more ports, which is operated either:*
- 1.4.1 *according to a published timetable; or*
- 1.4.2 *with crossings so regular or frequent that they constitute a recognisable systematic series;*
- 1.5 *“Stockholm Agreement” means the Agreement concluded at Stockholm on 27-28 February 1996 in pursuance of SOLAS 95 Conference Resolution 14 “Regional agreements on specific stability requirements for ro-ro passenger ships”, adopted on 29 November 1995;*
- 1.6 *“Host State” means a member State to or from whose ports a ro-ro passenger ship is engaged on a regular service;*
- 1.7 *“Specific stability requirements” means the stability requirements set out in regulations 25-4 and 25-5;*
- 1.8 *“Significant wave height” (h_s) is the average height of the highest third of wave heights observed over a given period;*
- 1.9 *“Residual freeboard (f_r) is the minimum distance between the damaged ro-ro deck and the final waterline at the location of the damage, without taking into account the additional effect of the water accumulated on the damaged ro-ro deck.*
- 2 *Sea areas*
- 2.1 *A map of sea areas and the corresponding significant wave heights in Northern Europe is reproduced on the following pages. The significant wave heights shall be used to calculate the height of water on the car deck used in the specific stability requirements. The figures for the significant wave height may not be exceeded with a probability of more than 10% a year.*

¹ *The Directive has been implemented in Danish law by Technical Regulation no. 6 issued by the Danish Maritime Authority of 27 October 2003 on a system of mandatory surveys for the safe operation of ro-ro ferries and high-speed passenger craft.*

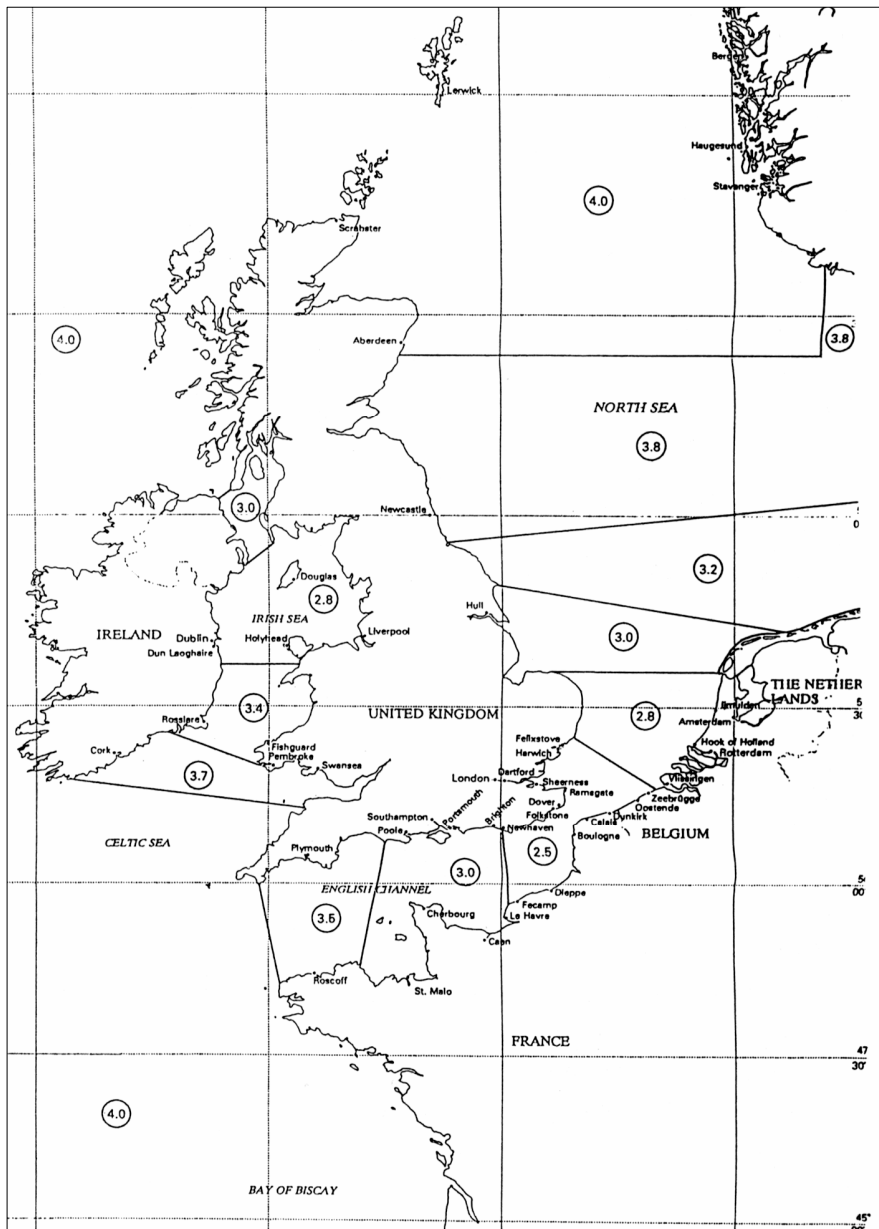

Regulation 25-3 – General provisions

- 1 *All ro-ro passenger ships referred to in this part shall comply with the specific stability requirements without prejudice to the requirements of SOLAS 74, chapter B II-1, regulation, relating to watertight subdivision and stability.*
- 2 *For ro-ro passenger ships operating exclusively in sea areas where the significant wave height is equal to or lower than 1.5 metres, compliance with the requirements of SOLAS 74, chapter B II-1, regulation 8, shall be considered equivalent to compliance with the specific stability requirements.*
- 3 *In applying the specific stability requirements, EU member States shall use the guidelines set out in annex I, insofar as this is practicable and compatible with the design of the ship in question.*

4 Certificates

- 4.1 *All new and existing ro-ro passenger ships flying the flag of an EU member State shall carry a certificate confirming compliance with the specific stability requirements. This certificate, which shall be issued by the Administration of the flag State and may be combined with other related certificates, shall indicate the significant wave height up to which the ship may satisfy the specific stability requirements. The certificate shall remain valid as long as the ship operates in an area with the same or a lower value of significant wave height.*
- 4.2 *Each EU member State acting in its capacity as host State shall recognise certificates issued by another EU member State.*
- 4.3 *Each EU member State acting in its capacity as host State shall accept certificates issued by a third country certifying that a ship complies with the specific stability requirements established.*

5 Seasonal and short-time period operations

- 5.1 *If a shipping company operating a regular service on a year-round basis wishes to introduce additional ro-ro passenger ships to operate for a shorter period on that service, it shall notify the competent authority of the host State or States not later than one month before the said ships are operated on that service. However, in cases where, following unforeseen circumstances, a replacement ro-ro passenger ship must be introduced rapidly to ensure continuity of service, Directive 1999/35/EC² shall apply.*
- 5.2 *If a shipping company wishes to operate seasonally a regular service for a shorter time period not exceeding six months a year, it shall notify the competent authority of the host State or States not later than three months before such operation takes place.*
- 5.3 *Where such operations take place under conditions of lower significant wave height than those established for the same sea area for all-year-round operation, the significant wave height value applicable for this shorter time period may be used by the competent authority for determining the height of water on the deck when applying the specific stability requirements.*
- 5.4 *Following agreement of the competent authority of the host State or States for operations within the meaning of regulations 25-3.5.1 and .2, the ro-ro passenger ship which undertakes such operations shall be required to carry a certificate confirming compliance with the specific stability requirements.*

Regulation 25-4 – Specific stability requirements for ro-ro passenger ships

- 1 *In addition to the requirements of SOLAS 74, chapter B II-1, regulation 8 relating to watertight subdivision and stability in damaged condition, all ro-ro passenger ships referred to in this part shall comply with the requirements of regulations 25-4 and 25-5.*
- 1.1 *The provisions of SOLAS 74, chapter B II-1, regulation 8.2.3 shall be complied with when taking into account the effect of a hypothetical amount of sea water which is assumed to have accumulated on the first deck above the design waterline of the ro-ro cargo space or the special cargo space as defined in SOLAS 74, chapter B II-2, regulation 3, assumed to be damaged (hereinafter referred to as ‘the damaged ro-ro deck’). The other requirements of SOLAS 74, chapter B II-1, regulation 8, need not be complied with in the application of the stability standard contained in regulations 25-4 and 25-5. The amount of assumed*

² *The Directive has been implemented in Danish law by Technical Regulation no. 6 issued by the Danish Maritime Authority of 27 October 2003 on a system of mandatory surveys for the safe operation of ro-ro ferries and high-speed passenger craft.*

accumulated sea water shall be calculated on the basis of a water surface having a fixed height above:

1.1.1 the lowest point of the deck edge of the damaged compartment of the ro-ro deck; or

1.1.2 when the deck edge of the damaged compartment is submerged then the calculation shall be based on a fixed height above the still water surface at all heel and trim angles;

as follows:

1.1.3 0.5 m if the residual freeboard (f_r) is 0.3 m or less,

1.1.4 0.0 m if the residual freeboard (f_r) is 2.0 m or more, and

1.1.5 intermediate values to be determined by linear interpolation, if the residual freeboard (f_r) is 0.3 m or more but less than 2.0 m,

where the residual freeboard (f_r) is the minimum distance between the damaged ro-ro deck and the final waterline at the location of the damage in the damage case being considered without taking into account the effect of the volume of assumed accumulated water on the damaged ro-ro deck.

1.2 When a high-efficiency drainage system is installed, the Administration of the flag State may allow a reduction in the height of the water surface.

1.3 For ships in geographically defined restricted areas of operation, the Administration of the flag State may reduce the height of the water surface prescribed in accordance with regulation 25-4.1.1 by substituting such height of the water surface by the following:

1.3.1 0.0 m if the significant wave height (h_s) defining the area concerned is 1.5 m or less;

1.3.2 the value determined in accordance with regulation 25-4.1.1 if the significant wave height (h_s) defining the area concerned is 4.0 m or above;

1.3.3 intermediate values to be determined by linear interpolation if the significant wave height (h_s) defining the area concerned is 1.5 m or more but less than 4.0 m,

provided that the following conditions are fulfilled:

1.3.4 the flag State Administration is satisfied that the defined area is represented by the significant wave height (h_s) which is not exceeded with a probability of more than 10%; and

1.3.5 the area of operation and, if applicable, the part of the year for which a certain value of the significant wave height (h_s) has been established are entered on the certificates.

1.4 As an alternative to the requirements of regulation 25-4.1.1 or 25-4.1.3, the flag State Administration may exempt application of the requirements and accept proof, established by model tests carried out for an individual ship in accordance with the model test method, which appears in regulation 25-5, justifying that the ship will not capsize with the assumed extent of damage as provided in SOLAS 74, chapter B II-1, regulation 8.4 in the worst location being considered under regulation 25-4.1.1 in an irregular seaway, and

1.5 reference to acceptance of the results of the model test as an equivalence to compliance with regulation 25-4.1.1 or 25-4.1.3 and the value of the significant wave height (h_s) used in the model tests shall be entered on the ship's certificates.

1.6 the information supplied to the master in accordance with SOLAS 74, chapter B II-1, regulation 8.7.1 and 8.7.2, as developed for compliance with SOLAS 74, chapter B II-1, regulations 8.2.3 to 8.2.3.4, shall apply unchanged for ro-ro passenger ships approved according to these requirements.

2 For assessing the effect of the volume of the assumed accumulated sea water on the damaged ro-ro deck in regulation 25-4.1, the following provisions shall prevail:

- 2.1 *a transverse or longitudinal bulkhead shall be considered intact if all parts of it lie inboard of vertical surfaces on both sides of the ship, which are situated at a distance from the shell plating equal to one-fifth of the breadth of the ship, as defined in regulation 2, and measured at right angles to the centreline at the level of the deepest subdivision load line;*
- 2.2 *in cases where the ship's hull is structurally partly widened for compliance with the specific stability requirements, the resulting increase of the value of one-fifth of the breadth of it is to be used throughout, but shall not govern the location of existing bulkhead penetrations, piping systems, etc., which were acceptable prior to the widening;*
- 2.3 *the tightness of transverse or longitudinal bulkheads which are taken into account as effective to confine the assumed accumulated sea water in the compartment concerned in the damaged ro-ro deck shall be commensurate with the drainage system, and shall withstand hydrostatic pressure in accordance with the results of the damage calculation. Such bulkheads shall be at least 4 m in height, unless the water height is less than 0.5 metres. In such cases, the height of the bulkheads may be calculated in accordance with the following:*

$$B_h = 8h_w$$

Where:

B_h is the bulkhead height and

H_w is the water height.

The minimum height of the bulkhead may under no circumstances be less than 2.2 metres. However, in case of a ship with hanging car decks, the minimum height of the bulkhead shall be not less than the height to the underside of the hanging deck when in its lowered position;

- 2.4 *for special arrangements such as, e.g., full-width hanging decks and wide side casings, other bulkhead heights may be accepted on the basis of detailed model tests;*
- 2.5 *the effect of the volume of the assumed accumulated sea water need not be taken into account for any compartment of the damaged ro-ro deck, provided that such a compartment has on each side of the deck freeing ports evenly distributed along the sides of the compartment complying with the following:*

$$2.5.1 \quad A \geq 0.3 l$$

where

A is the total area of freeing ports on each side of the deck in m²; and

l is the length of the compartment in m;

- 2.5.2 *the ship shall maintain a residual freeboard of at least 1.0 m in the worst damage condition without taking into account the effect of the assumed volume of water on the damaged ro-ro deck; and*
- 2.5.3 *such freeing ports shall be located within the height of 0.6 m above the damaged ro-ro deck, and the lower edge of the ports shall be within 2 cm above the damaged ro-ro deck; and*

- 2.5.4 *such freeing ports shall be fitted with closing devices or flaps to prevent water entering the ro-ro deck whilst allowing water which may accumulate on the ro-ro deck to drain.*
- 2.6 *When a bulkhead above the ro-ro deck is assumed damaged, both compartments bordering the bulkhead shall be assumed flooded to the same height of water surface as calculated in regulation 25-4.1.1 or 25-4.1.3.*
- 3 *When determining significant wave height, the wave heights given on the maps or list of sea areas established by the EU member States in line with regulation 25-2.2 shall be used.*
- 3.1 *For ships which are to be operated only for a shorter season, the host State Administration shall determine in agreement with the other countries whose ports are included in the ship's route, the significant wave height to be used.*
- 4 *Model tests shall be conducted in accordance with the regulation 25-5.*

Regulation 25-5 – Model test method

1 Objectives

This revised model test method is a revision of the method contained in the Appendix to the Annex to resolution 14 of the 1995 SOLAS Conference. Since the entry into force of the Stockholm Agreement a number of model tests has been carried out in accordance with the test method previously in force³. During these tests a number of refinements in the procedures have been identified. This new model test method aims to include these refinements and, together with the appended Guidance Notes, provide a more robust procedure for the assessment of survivability of a damaged ro-ro passenger ship in a seaway. In the tests provided for in regulation 25-4.1.4, the ship should be capable of withstanding a seaway as defined in regulation 25-4.1 in the worst damage-case scenario.

2 Definitions

- .1 L_{BP} is the length between perpendiculars*
- .2 h_s is the significant wave height*
- .3 B is the moulded breadth of the ship*
- .4 T_p is the peak period*
- .5 T_z is the zero crossing period*

3 Ship model

3.1 *The model shall copy the actual ship for both outer configuration and internal arrangement, in particular all damaged spaces having an effect on the process of flooding and shipping of water. Intact draught, trim, heel and limiting operational KG corresponding to the worst damage case shall be used. Furthermore, the test case(s) to be considered shall represent the worst damage case(s) defined in accordance with SOLAS 74, chapter B II-1, regulation 8.2.3.2, with regard to the total area under the positive GZ curve and the centreline of the damage opening shall be located within the following range:*

- .1 $\pm 35\%$ L_{BP} from midship;*
- .2 an additional test will be required for the worst damage within $\pm 10\%$ L_{BP} from midship if the damage case referred to in regulation 25-5.3.1 is outside of $\pm 10\%$ L_{BP} from midship.*

3.2 *The model shall comply with the following:*

³ *The Danish Maritime Authority shall accept approvals for existing ships made on the basis of model tests carried out in accordance with the previous method of Technical Regulation no. 2 of 3 march 1998, appendix 3, issued by the Danish Maritime Authority.*

- 3.2.1 length between perpendiculars (L_{BP}) is to be at least 3 m or a length corresponding to a model scale of 1:40, whichever is greater, and the vertical extent up to at least three superstructure standard heights above the bulkhead (freeboard) deck;
- 3.2.2 hull thickness of flooded spaces may not exceed 4 mm;
- 3.2.3 in both intact and damaged conditions, the model shall satisfy the correct displacement and draught marks (T_A, T_M, T_F , port and starboard) with a maximum tolerance in any one draught mark of + 2 mm. Draught marks forward and aft shall be located as near FP and AP as practicable;
- 3.2.4 all damaged compartments and ro-ro spaces shall be modelled with the correct surface and volume permeabilities (actual values and distributions) ensuring that floodwater mass and mass distribution are correctly represented;
- 3.2.5 the characteristics of motion of the actual ship shall be modelled properly, paying particular attention to the intact GM tolerance and radii of gyration in roll and pitch motion. Both radii shall be measured in air and be in the range of 0.35B to 0.4B for roll motion, and 0.2LOA to 0.25LOA for pitch motion;
- 3.2.6 main design features such as watertight bulkheads, air escapes, etc., above and below the bulkhead deck that can result in asymmetric flooding shall be modelled properly as far as practicable to represent the real situation; Ventilating and cross-flooding arrangements shall be constructed to a minimum cross section of 500 mm²;
- 3.2.7 the shape of the damage opening shall be as follows:
 - 3.2.7.1 trapezoidal profile with side at 15° slope to the vertical and the width at the design waterline defined according to SOLAS 74, chapter B II-1, regulation 8.4.1;
 - 3.2.7.2 isosceles triangular profile in the horizontal plane with the height equal to B/5 according to SOLAS 74, chapter B II-1, regulation 8.4.2. If side casings are fitted within B/5, the damaged length in way of the side casings shall not be less than 25 mm;
 - 3.2.7.3 notwithstanding the provisions of regulations 25-5.3.2.7.1 and 25-5.3.2.7.2 above, all compartments taken as damaged in calculating the worst damage case(s) referred to in regulation 25-5.3.1 shall be flooded in the model tests.
- 3.3 The model in the flooded equilibrium condition shall be heeled by an additional angle corresponding to that induced by the heeling moment $M_h = \max(M_{pass}, M_{launch}) - M_{wind}$, but in no case shall the final heel be less than 1° towards damage. M_{pass} , M_{launch} and M_{wind} are as specified in SOLAS 74, chapter II-1, regulation 8.2.3.4. For existing ships this angle may be taken as 1°.

4 Procedure for experiments.

- 4.1 The model shall be tested in a long-crested irregular seaway defined by the JONSWAP spectrum with significant wave height h_s , a peak enhancement factor $\gamma = 3.3$ and a peak period $T_P = 4\sqrt{h_s}$ ($T_z = T_P/1.285$). h_s is the significant wave height for the area of operation, which is not exceeded by a probability of more than 10% on a yearly basis, but limited to a maximum of 4 m.
Furthermore,
 - 4.1.1 the basin width shall be sufficient to avoid contact or other interaction with the sides of the basin and is recommended not to be less than $L_{BP} + 2m$;
 - 4.1.2 the basin depth shall be sufficient for proper wave modelling but shall not be less than 1 m;
 - 4.1.3 for a representative wave realisation to be used, measurements shall be performed prior to the test at three different locations within the drift range;

- 4.1.4 *the wave probe closer to the wave maker shall be located at the position where the model is placed when the test starts;*
- 4.1.5 *variation in h_s and T_p shall be within $\pm 5\%$ for the three locations; and*
- 4.1.6 *during the tests, for approval purposes, a tolerance of $+ 2.5\%$ in h_s , $\pm 2.5\%$ in T_p and $\pm 5\%$ in T_z shall be allowed with reference to the probe closer to the wave maker.*
- 4.2 *The model shall be free to drift and placed in beam seas (90° heading) with the damage hole facing the oncoming waves, with no mooring system permanently attached to the model used. To maintain a beam sea heading of approximately 90° during the model test the following requirements shall be satisfied:*
 - 4.2.1 *heading control lines, intended for minor adjustment, shall be located at the centre line of the stem and stern, in a symmetrical fashion and at a level between the position of KG and the damaged waterline; and*
 - 4.2.2 *the carriage speed shall be equal to the actual drift speed of the model with speed adjustment made when necessary.*
- 4.3 *At least 10 experiments shall be carried out. The test period for each experiment shall be of a duration such that a stationary state is reached, but not less than 30 min in full-scale. A different wave realisation train shall be used for each experiment.*
- 5 *Survival criteria.*

The ship shall be considered as surviving if a stationary state is reached for the successive test runs as required in regulation 25-5.4.3. The model shall be considered as capsized if angles of roll of more than 30° to the vertical axis or steady (average) heel greater than 20° for a period longer than three minutes full-scale occur, even if a stationary state is reached.
- 6 *Test documentation*
 - 6.1 *The model test programme shall be approved by the Administration in advance.*
 - 6.2 *Tests shall be documented by means of a report and a video or other visual records containing all relevant information on the model and the test results, which are to be approved by the Administration. These shall include, as a minimum, the theoretical and measured wave spectra and statistics (h_s , T_p , T_z) of the wave elevation at the three different locations in the basin for a representative realisation, and for the tests with the model, the time series of main statistics of the measured wave elevation close to the wave maker and records of model roll, heave and pitch motions, and of the drift speed.*

Annex 1
Indicative guidelines to national administrations
PART I

Application

In line with the provisions of regulation 25-3.3, these guidelines shall be used by the national Administrations of member States in the application of the specific stability requirements, in so far as this is practicable and compatible with the design of the ship in question. The paragraph numbers appearing below correspond to those in regulations 25-4 and 25-5.

25-4.1

As a first step all ro-ro passenger ships referred to in this part shall comply with the SOLAS 90 standard of residual stability as it applies to all passenger ships constructed on or after 29 April 1990. It is the application of this requirement that defines the residual freeboard f_r , necessary for the calculations required in regulation 25-4.1.1.

25-4.1.1

- 1 This regulation addresses the application of a hypothetical amount of water accumulated on the bulkhead (ro-ro) deck. The water is assumed to have entered the deck via a damage opening. This regulation requires that the ship in addition to complying with the full requirements of the SOLAS 90 standard further complies with that part of the SOLAS 90 criteria contained in points 2.3 to 2.3.4 of SOLAS 74, chapter B II-1, regulation 8, with the defined amount of water on deck. For this calculation no other requirements of SOLAS 74, chapter B II-1, regulation 8, need be taken into account. For example the ship does not, for this calculation, need to comply with the requirements for the angles of equilibrium or non-submergence of the margin line.*
- 2 The accumulated water is added as a liquid load with one common surface inside all compartments which are assumed flooded on the car deck. The height (h_w) of water on deck is dependent on the residual freeboard (f_r) after damage, and is measured in way of the damage (see figure 1). The residual freeboard, is the minimum distance between the damaged ro-ro deck and the final waterline (after equalisation measures if any have been taken) in way of the assumed damage after examining all possible damage scenarios in determining the compliance with the SOLAS 90 standard as required in regulation 25-4.1. No account shall be taken of the effect of the hypothetical volume of water assumed to have accumulated on the damaged ro-ro deck when calculating f_r .*
- 3 If f_r is 2.0 m or more, no water is assumed to accumulate on the ro-ro deck. If f_r is 0.3 m or less, then height h_w is assumed to be 0.5 m. Intermediate heights of water are obtained by linear interpolation (see figure 2).*

25-4.1.2

Means for drainage of water can only be considered as effective if these means are of a capacity to prevent large amounts of water from accumulating on the deck i.e. many thousands of tonnes per hour which is far beyond the capacities fitted at the time of the adoption of these regulations. Such high efficiency drainage systems may be developed and approved in the future (based on guidelines to be developed by the International Maritime Organisation).

25-4.1.3

- 1 *The amount of assumed accumulated water on deck may, in addition to any reduction in accordance with regulation 25-4.1.1, be reduced for operations in geographically defined restricted areas. These areas are designated in accordance with the significant wave height (h_s) defining the area in line with the provisions of regulation 25-2.2.*
- 2 *If the significant wave height (h_s), in the area concerned is 1.5 m or less, then no additional water is assumed to accumulate on the damaged ro-ro deck. If the significant wave height in the area concerned is 4.0 m or more, then the height of the assumed accumulated water shall be the value calculated in accordance with regulation 25-4.1.1. Intermediate values to be determined by linear interpolation (see figure 3).*
- 3 *The height h_w is kept constant, therefore the amount of added water is variable as it is dependent upon the heeling angle and whether at any particular heeling angle the deck edge is immersed or not (see figure 4). It shall be noted that the assumed permeability of the car deck spaces is to be taken as 90% (cf. MSC/Circ.649), whereas other assumed flooded spaces permeabilities are to be those prescribed in regulation 5.*
- 4 *If the calculations to demonstrate compliance with the specific stability requirements relate to a significant wave height less than 4.0 m, that restricting significant wave height shall be recorded on the vessel's passenger ship safety certificate.*

25-4.1.4 and .1.5

As an alternative to complying with the new stability requirements in regulation 25-4.11 or 25-4.1.3 an Administration may accept proof of compliance via model tests. The model test requirements are detailed in regulation 25-5. Guidance notes on the model tests are contained in part II of this Annex.

25-4.1.6

Conventionally derived SOLAS 90 standard limiting operational curve(s) (KG or GM) may not remain applicable in cases where 'water on deck' is assumed under the terms of regulation 25-4 and it may be necessary to determine revised limiting curve(s) which take into account the effects of this added water. To this effect sufficient calculations corresponding to an adequate number of operational draughts and trims shall be carried out.

Note: Revised limiting operational KG/GM curves may be derived by iteration, whereby the minimum excess GM resulting from damage stability calculations with water on deck is added to the input KG (or deducted from the GM) used to determine the damaged freeboards (f_r), upon which the quantities of water on deck are based, this process being repeated until the excess GM becomes negligible.

It is anticipated that operators would begin such an iteration with the maximum KG/minimum GM which could reasonably be sustained in service and would seek to manipulate the resulting deck bulkhead arrangement to minimise the excess GM derived from damage stability calculations with water on deck.

25-4.2.1

As for conventional SOLAS damage requirements bulkheads inboard of the B/5 line are considered intact in the event of side collision damage.

25-4.2.2

If side structural sponsons are fitted to enable compliance with this regulation, and as a consequence there is an increase in the breadth (B) of the ship and hence the vessel's B/5 distance

from the ship's side, such modification shall not cause the relocation of any existing structural parts or any existing penetrations of the main transverse watertight bulkheads below the bulkhead deck (see figure 5).

25-4.2.3

- 1 Transverse or longitudinal bulkheads/barriers which are fitted and taken into account to confine the movement of assumed accumulated water on the damaged ro-ro deck need not be strictly 'watertight'. Small amounts of leakage may be permitted subject to the drainage provisions being capable of preventing an accumulation of water on the 'other side' of the bulkhead/barrier. In such cases where scuppers become inoperative as a result of a loss of positive difference of water levels other means of passive drainage shall be provided.
- 2 The height (B_h) of transverse and longitudinal bulkheads/barriers shall be not less than $(8 \times h_w)$ metres, where h_w is the height of the accumulated water as calculated by application of the residual freeboard and significant wave height (as referred to in regulations 25-4.1.1 and 25-4.1.3). However in no case is the height of the bulkhead/barrier to be less than the greater of:
 - 2.1 2.2 metres; or
 - 2.2 the height between the bulkhead deck and the lower point of the underside structure of the intermediate or hanging car decks, when these are in their lowered position. It should be noted that any gaps between the top edge of the bulkhead and the underside of the plating must be 'plated-in' in the transverse or longitudinal direction as appropriate (see figure 6).

Bulkheads/barriers with a height less than that specified above may be accepted if model tests are carried out in accordance with part II to confirm that the alternative design ensures appropriate standard of survivability. Care needs to be taken when fixing the height of the bulkhead/barrier such that the height shall also be sufficient to prevent progressive flooding within the required stability range. This range is not to be prejudiced by model tests.

Note: The range may be reduced to 10 degrees provided the corresponding area under the curve is increased (cf. MSC 64/22).

25-4.2.5.1

The area 'A' relates to permanent openings. It should be noted that the 'freeing ports' option is not suitable for ships which require the buoyancy of the whole or part of the superstructure in order to meet the criteria. The requirement is that the freeing ports shall be fitted with closing flaps to prevent water entering, but allowing water to drain.

These flaps may not rely on active means. They shall be self-operating and it shall be shown that they do not restrict outflow to a significant degree. Any significant efficiency reduction shall be compensated by the fitting of additional openings so that the required area is maintained.

25-4.2.5.2

For the freeing ports to be considered effective the minimum distance from the lower edge of the freeing port to the damaged waterline shall be at least 1.0 m. The calculation of the minimum distance shall not take into account the effect of any additional water on deck (see figure 7).

25-4.2.5.3

Freeing ports shall be sited as low as possible in the side bulwark or shell plating. The lower edge of the freeing port opening shall be no higher than 2 cm above the bulkhead deck and the upper edge of the opening no higher than 0.6 m (see figure 8).

Note: Spaces to which regulation 25-4.2.5 applies, i.e. those spaces fitted with freeing ports or similar openings, shall not be included as intact spaces in the derivation of the intact and damage stability curves.

25-4.2.6

- 1 *The statutory extent of damage is to be applied along the length of the ship. Depending on the subdivision standard the damage may not affect any bulkhead or may only affect a bulkhead below the bulkhead deck or only bulkhead above the bulkhead deck or various combinations.*
- 2 *All transverse and longitudinal bulkheads/barriers which constrain the assumed accumulated amount of water shall be in place and secured at all times when the ship is at sea.*
- 3 *In those cases where the transverse bulkhead/barrier is damaged the accumulated water on deck shall have a common surface level on both sides of the damaged bulkhead/barrier at the height h_w (see figure 9).*

PART II MODEL TESTING

The purpose of these guidelines is to ensure uniformity in the methods employed in the construction and verification of the model as well as in the undertaking and analyses of the model tests, while appreciating that available facilities and costs will affect in some way this uniformity.

The content of regulations 25-5.1 and .2 is self-explanatory.

25-5.3 – Ship model

- 1 *The material of which the model is made is not important in itself, provided that the model both in the intact and damaged condition is sufficiently rigid to ensure that its hydrostatic properties are the same as those of the actual ship and also that the flexural response of the hull in waves is negligible.*

It is also important to ensure that the damaged compartments are modelled as accurately as practicably possible to ensure that the correct volume of flood water is represented.

Since ingress of water (even small amounts) into the intact parts of the model will affect its behaviour, measures shall be taken to ensure that this ingress does not occur.

In model tests involving worst SOLAS damages near the ship ends, it has been observed that progressive flooding was not possible because of the tendency of the water on deck to accumulate near the damage opening and hence flow out. As such models were able to survive very high sea states, while they capsized in lesser sea states with less onerous SOLAS damages, away from the ends, the limit $\pm 35\%$ was introduced to prevent this.

Extensive research carried out for the purpose of developing appropriate criteria for new vessels has clearly shown that in addition to the GM and freeboard being important parameters in the survivability of passenger ships, the area under the residual stability curve is also another major factor. Consequently in choosing the worst SOLAS damage for compliance with the requirement of regulation 25-5.3.1 the worst damage is to be taken as that which gives the least area under the residual stability curve.

- 2 *Model particulars*

- 2.1 *In recognising that scale effects play an important role in the behaviour of the model during tests, it is important to ensure that these effects are minimised as much as practically possible. The model shall be as large as possible since details of damaged compartments are easier constructed in larger models and the scale effects are reduced. It is therefore required that the model length is not less than that corresponding to 1:40*

scale. However it is required that the model is not less than 3 metres long at the subdivision load line.

It has been found during tests that the vertical extent of the model can affect the results when tested dynamically. It is therefore required that the ship is modelled to at least three super structure standard heights above the bulkhead (freeboard) deck so that the large waves of the wave train do not break over the model.

- 2.2 The model in way of the assumed damages shall be as thin as practically possible to ensure that the amount of flood water and its centre of gravity is adequately represented. The hull thickness may not be more than 4 mm. It is recognised that it may not be possible for the model hull and the elements of primary and secondary subdivision in way of the damage to be constructed with sufficient detail and due to these constructional limitations it may not be possible to calculate accurately the assumed permeability of the space.
- 2.3 It is important that not only the draughts in the intact condition are verified, but also that the draughts of the damaged model are accurately measured for correlation with those derived from the damaged stability calculation. For practical reasons a tolerance of +2 mm will be accepted on all draught values.
- 2.4 After measuring the damaged draughts it may be found necessary to make adjustments to the permeability of the damaged compartment by either introducing intact volumes or by adding weights. However it is also important to ensure that the centre of gravity of the flood water is accurately represented. In this case any adjustments made shall err on the side of safety.

If the model is required to be fitted with barriers on deck and the barriers are less than the height required below, the model is to be fitted with TV monitors so that any 'splashing over' and any accumulation of water on the undamaged area of the deck can be monitored. In this case a video recording of the event is to form part of the test records.

The height of transverse or longitudinal bulkheads which are taken into account as effective to confine the assumed accumulated sea water in the compartment concerned in the damaged ro-ro deck shall be at least 4 m in height unless the height of water is less than 0.5 m. In such cases the height of the bulkhead may be calculated in accordance with the following:

$$B_h = 8h_w$$

where B_h is the bulkhead height; and

h_w is the height of water.

In any event, the minimum height of the bulkhead shall be not less than 2.2 m. However, in the case of a ship with hanging car decks, the minimum height of the bulkhead shall be not less than the height to the underside of the hanging car deck when in its lowered position.

- 2.5 In order to ensure that the model motion characteristics represent those of the actual ship it is important that the model is both inclined and rolled in the intact condition so that the intact GM and the mass distribution are verified. The mass distribution shall be measured in air. The transverse radius of gyration of the actual ship shall be in the range 0.35B to 0.4B and the longitudinal radius of gyration should be in the range 0.2L to 0.25L.
Note: While inclining and rolling the model in the damaged condition may be accepted as a check for the purpose of verifying the residual stability curve, such tests shall not be accepted in lieu of the intact tests.

2.6 It is assumed that the ventilators of the damage compartment of the actual ship are adequate for unhindered flooding and movement of the flood water. However in trying to scale down the ventilating arrangements of the actual ship undesirable scale effects may be introduced in the model. In order to ensure that no such effects occur it is recommended to construct the ventilating arrangements to a larger scale than that of the model, ensuring that this does not affect the flow of water on the car deck.

2.7 It is deemed appropriate to consider a damage shape representative of a cross section of the striking ship in the bow region. The 15° angle is based on a study of the cross section at a distance of B/5 from the bow for a representative selection of vessels of different types and sizes.

The isosceles triangular profile of the prismatic damage shape is that corresponding to the load waterline.

Additionally in cases where side casings of width less than B/5 are fitted and in order to avoid any possible scale effects, the damage length in way of the side casings shall not be less than 25 mm.

3 In the original model test method of resolution 14 of the 1995 SOLAS Conference the effect of heeling induced by the maximum moment deriving from any of passenger crowding, launching of survival craft, wind and turning was not considered even though this effect was part of SOLAS. Results from an investigation have shown, however, that it would be prudent to take these effects into account and to retain the minimum of 1° heel towards the damage for practical purposes. It is to be noted that heeling due to turning was considered not to be relevant.

4 In cases where there is a margin in GM in the actual loading conditions compared to the GM limiting curve (derived from SOLAS 90), the Administration may accept that this margin is taken advantage of in the model test. In such cases the GM limiting curve shall be adjusted. This adjustment can be done as follows:

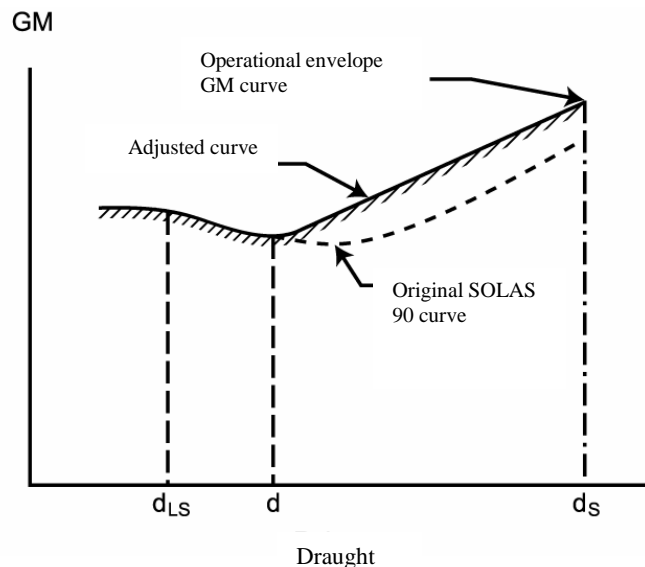

$$d = d_s - 0,6 (d_s - d_{LS})$$

where: d_s is the subdivision draught; and d_{LS} is the lightship draught.

The adjusted curve is a straight line between the GM used in the model test at the subdivision draught and the intersection of the original SOLAS 90 curve and draught d.

25-5.4 – Procedure for experiments

1.1 Wave spectra

The JONSWAP spectrum shall be used as this describes fetch- and duration-limited seas which correspond to the majority of conditions world wide. In this respect it is important that not only the peak period of the wave train is verified but also that the zero crossing period is correct.

It is required that for every test run the wave spectrum is recorded and documented.

Measurements for this recording shall be taken at the probe closest to the wave making machine.

It is also required that the model is instrumented so that its motions (roll, heave and pitch) as well as its attitude (heel, sinkage and trim) are monitored and recorded through-out the test.

It has been found that it is not practical to set absolute limits for significant wave heights, peak periods and zero crossing periods of the model wave spectra. An acceptable margin has therefore been introduced.

1.2 *To avoid interference of the mooring system with the ship dynamics, the towing carriage (to which the mooring system is attached) shall follow the model at its actual drifting speed. In a sea state with irregular waves the drift speed will not be constant; a constant carriage speed would result in low frequency, large amplitude drift oscillations, which may affect the model behaviour.*

1.3 *A sufficient number of tests in different wave trains shall be necessary to ensure statistical reliability, i.e. the objective shall be to determine with a high degree of confidence that an unsafe ship will capsize in the selected conditions. A minimum number of 10 runs shall be considered to provide a reasonable level of reliability.*

25-5.5 – Survival criteria

The contents of this paragraph are considered self-explanatory.

25-5.6 – Test approval

The following documents shall be part of the report to the Administration:

- (a) damage stability calculations for worst SOLAS and mid-ship damage (if different);*
- (b) general arrangement drawing of the model together with details of construction and instrumentation;*
- (c) inclining experiment and measurements of radii of gyration;*
- (d) nominal and measured wave spectra (at the three different locations for a representative realisation and for the tests with the model from the probe closest to the wave maker);*
- (e) representative record of model motions, attitude and drift;*
- (f) relevant video recordings.*

Note: All tests shall be witnessed by the Administration.

Figures referring to annex I

Figure 1: SOLAS damage length

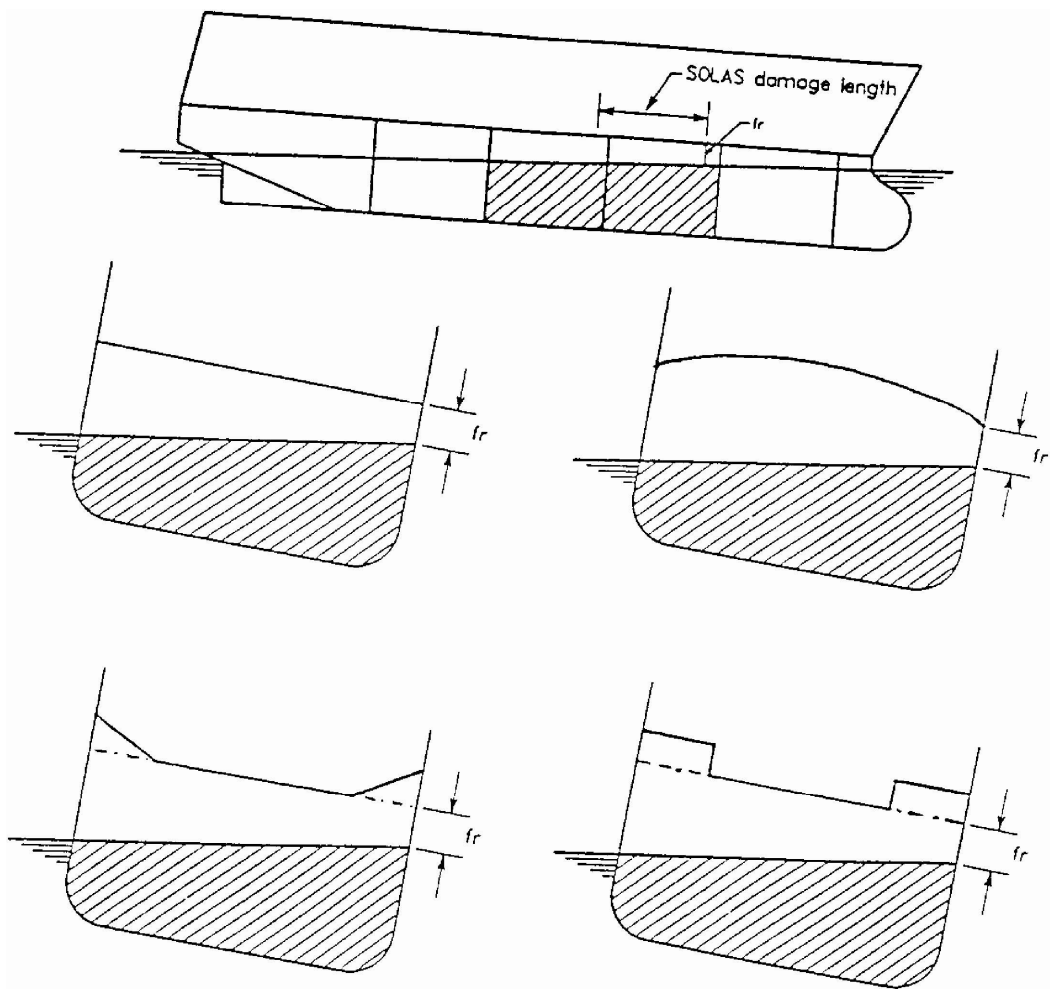
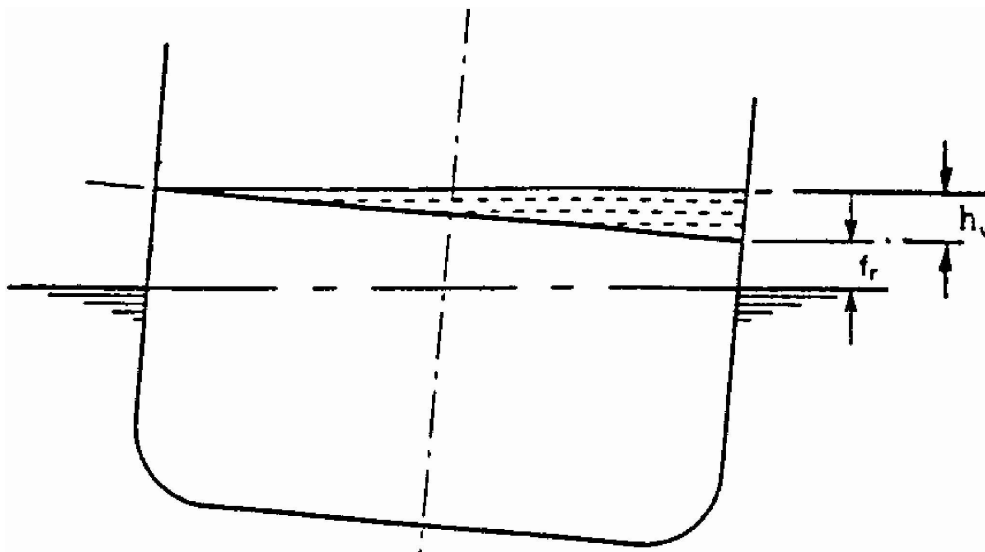
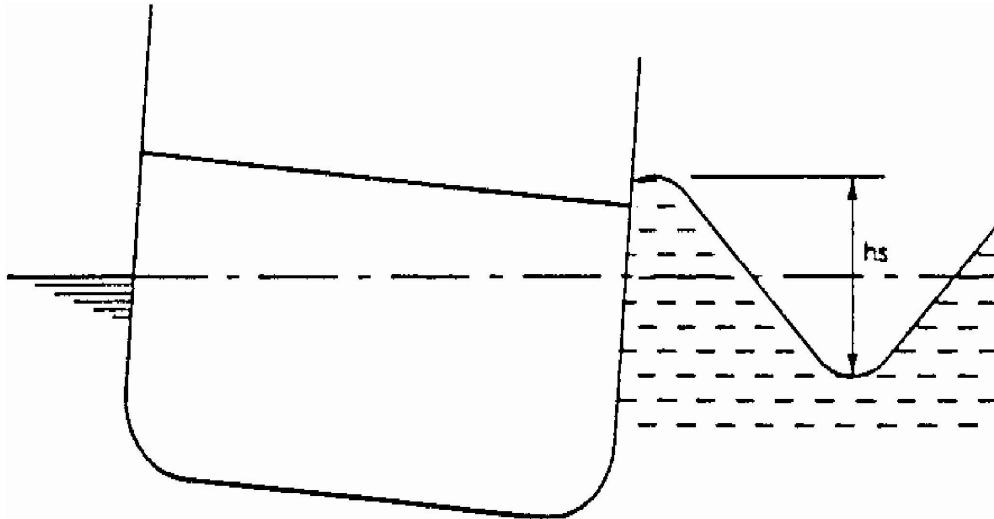

Figure 2



1. If $f_r \geq 2.0$ metres, height of water on deck (h_w) = 0.0 metres.
2. If $f_r < 0.3$ metres, height of water on deck (h_w) = 0.5 metres.

Figure 3



1. If $h_s \geq 4.0$ metres, height of water on deck is calculated as per figure 3.
2. If $h_s < 1.5$ metres, height of water on deck (h_w) = 0.0 metres.

For example:

If $f_r = 1.15$ metres and $h_s = 2.75$ metres, height $h_w = 0.125$ metres.

Figure 4

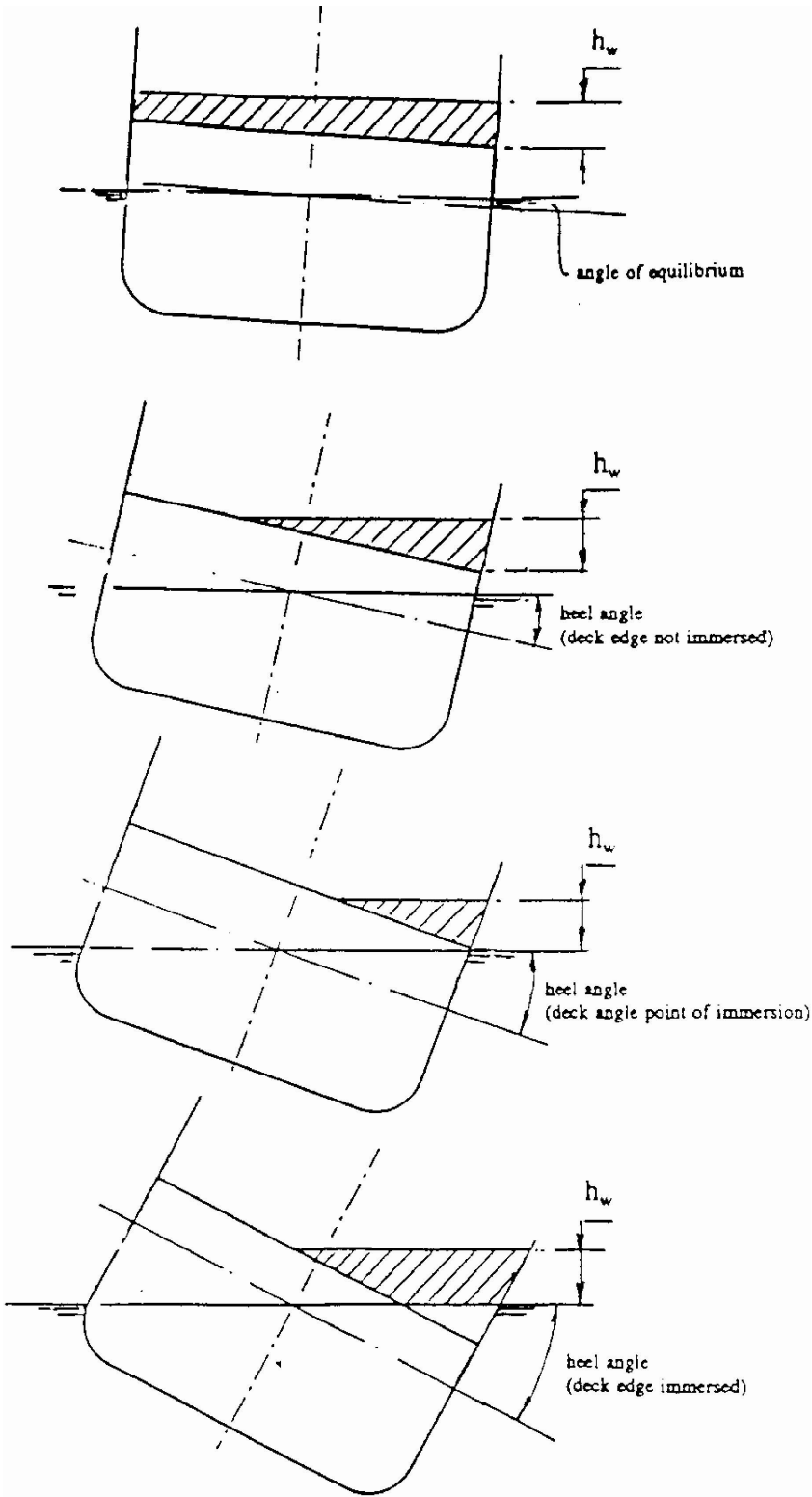

Figure 5

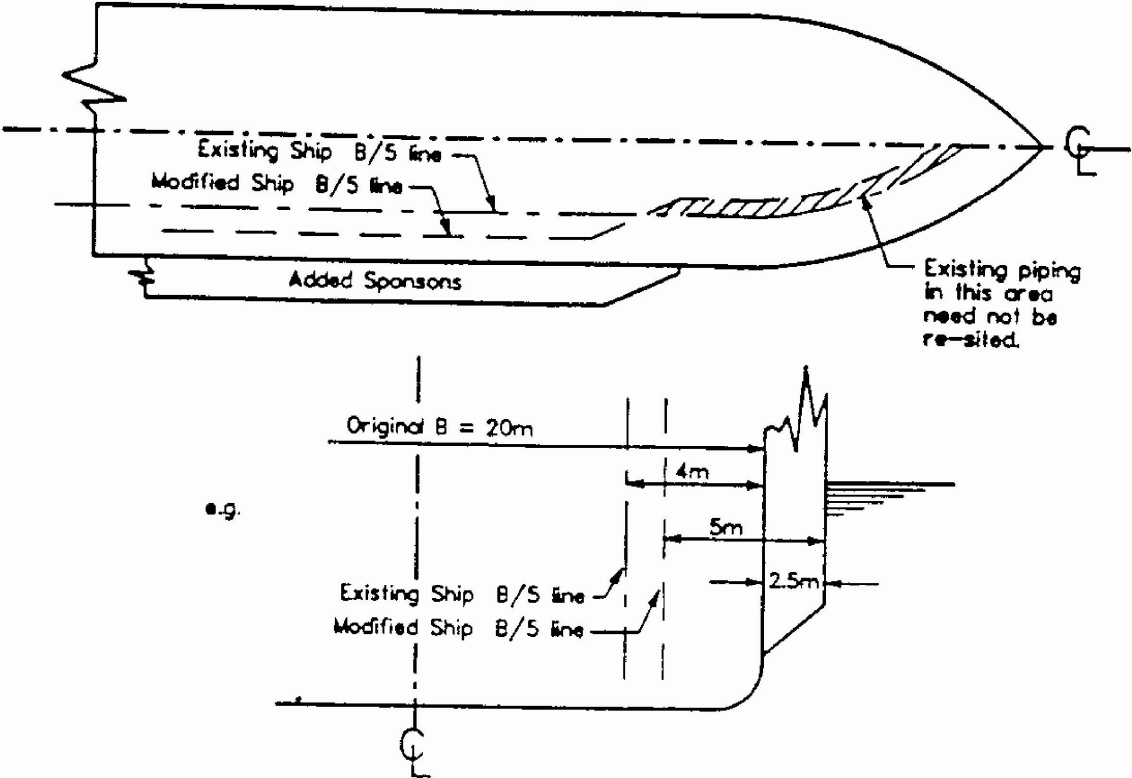

Figure 6

Ship without hanging car decks

Example 1:

Height of water on deck = 0.25 metres

Minimum required height of barrier = 2.2 metres

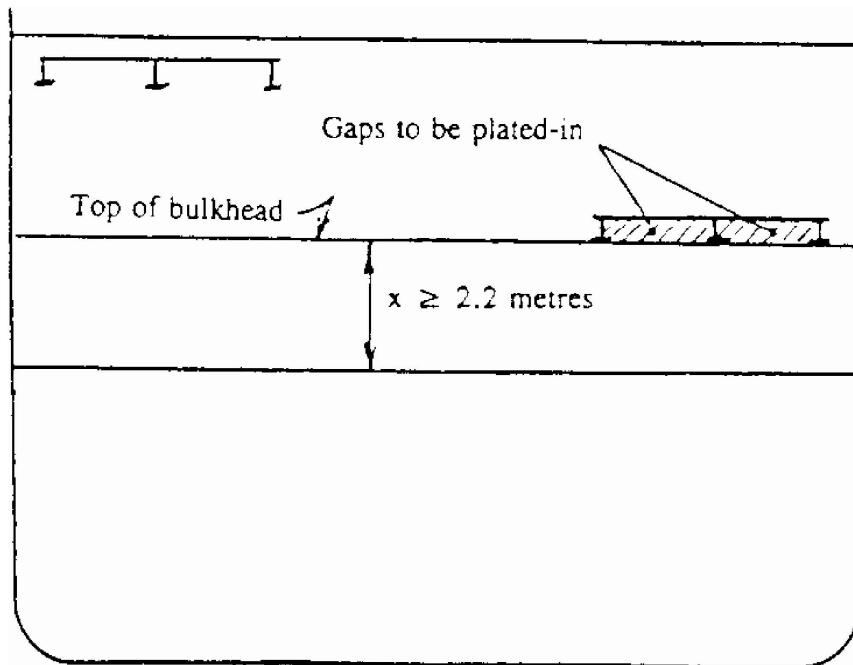

Ship with hanging deck (in way of the barrier)

Example 2:

Height of water on deck (hw) = 0.25 metres

Minimum required height of barrier = x

Figure 7

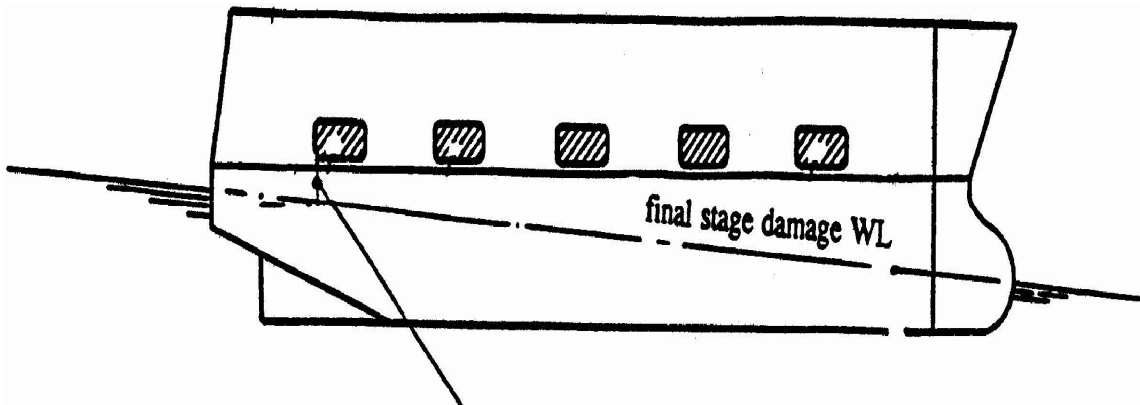

Minimum required freeboard to freeing port = 1.0 m

Figure 8

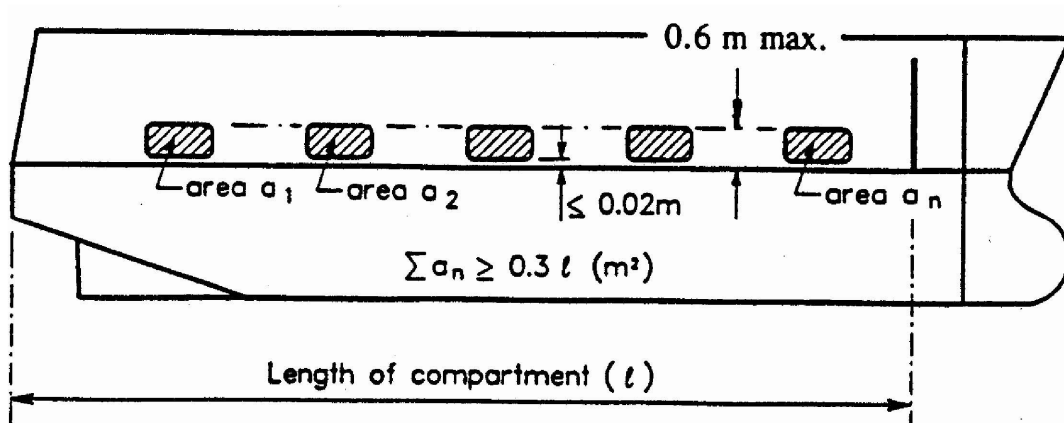
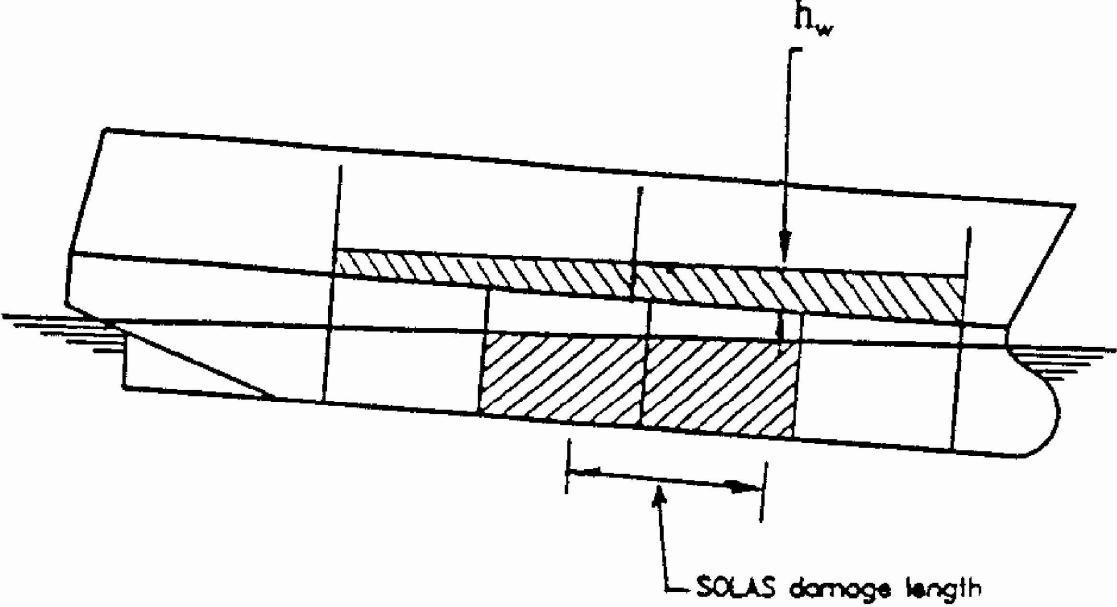
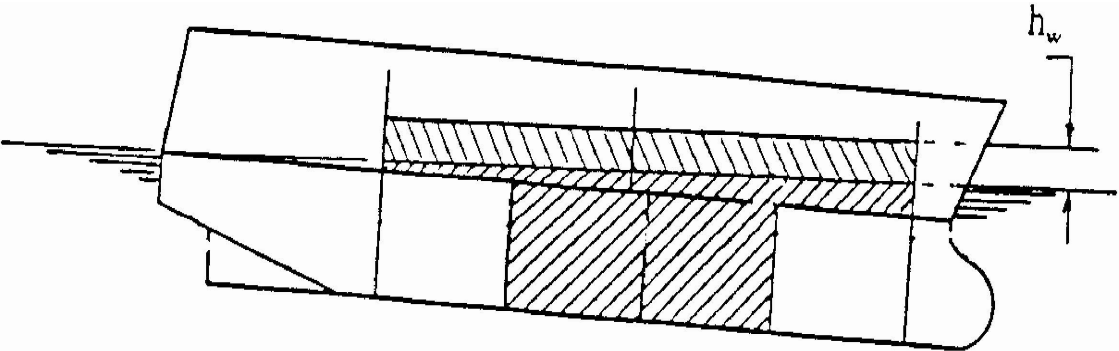

Figure 9



Deck edge not immersed.



Deck edge immersed

Annex II

Implementation of specific stability requirements for passenger ships

98/18 type of ro-ro passenger ship	Date of construction	Applicable regulations	Date of application
1. Ro-ro passenger ships engaged in international voyages, of whatever flag, and operating a regular service to or from a member State port	Before 1 October 2004	SOLAS 90 + 2003/25 Annex I	(a) 1 October 2010 (excluded if operating in sea areas with < 1,5 metre significant wave height) (b) 1 October 2015 (if on 17 May 2003 compliant with SOLAS 90 standard)
	Between 1 October 2004 and 31 December 2008	SOLAS 90 + 2003/25 Annex I	Upon construction
2. Class A ro-ro passenger ships engaged in exclusively domestic voyages	On or after 1 January 2009	SOLAS 2009 + 2003/25 Annex I	Upon construction
	Before 1 October 2004	SOLAS 90 + 2003/25 Annex I	1 October 2010 (unless phased out after 30 years by 2015 at latest)
3. Class B ro-ro passenger ships engaged in exclusively domestic voyages, of whatever flag	Between 1 October 2004 and 31 December 2008	SOLAS 90 + 2003/25 Annex I	Upon construction
	On or after 1 January 2009	SOLAS 2009 + 2003/25 Annex I	Upon construction
	Before 1 October 2004	98/18, ch. II-1 part B + 2003/25 Annex I	1 October 2010 (unless phased out after 30 years by 2015 at latest)
	Between 1 October 2004 and 31 December 2008	98/18, ch. II-1 part B + 2003/25 Annex I	Upon construction
4. Class C ro-ro passenger ships engaged in exclusively domestic	On or after 1 January 2009 until the date of transposition of the amending Commission Directive.*	98/18, ch. II-1 part B + 2003/25 Annex I	Upon construction
	Following the date of transposition of the amending Commission Directive.*	98/18, ch. II-1 part B + 2003/25 Annex I	Upon construction
	Before 1 October 2004	SOLAS 2009 + 2003/25 Annex I	Not applicable
	Between 1 October 2004 and 31	Not applicable 98/18, ch. II-1 part B + 2003/25	Upon construction

voyages, whatever flag	December 2008	Annex I	
	On or after 1 January 2009 until the date of transposition of the amending Commission Directive.*	98/18 ch. II-1 part B + 2003/25 Annex I	Upon construction
5. Class D ro-ro passenger ships engaged in exclusively domestic voyages, of whatever flag	Following the date of transposition of the amending Commission Directive.*	98/18, ch. II-1 part B + 2003/25 Annex I or SOLAS 2009 + 2003/25 Annex I	Upon construction
	Before 1 October 2004	Not applicable	Not applicable
	Between 1 October 2004 and 31 December 2008	98/18, ch. II-1 part B	Upon construction
	On or after 1 January 2009 until the date of transposition of the amending Commission Directive.*	98/18, ch. II-1 part B	Upon construction
	Following the date of transposition of the amending Commission Directive.*	98/18, ch. II-1 part B or SOLAS 2009	Upon construction

Notes:

1. References to Directive 98/18/EC will be taken as references to the new codifying Directive, as amended.
2. SOLAS 90 is to mean the SOLAS regulations applicable prior to 31 December 2008.

* Commission Directive amending Directive 98/18/EC to allow ships in classes B, C and D the option of being built according to SOLAS 2009 rules.

shore facilities, acceptable to the Administration shall be provided for disposing of the oily-water ballast.

- 3 The provisions of this regulation are without prejudice to the provisions of the International Convention for the Prevention of Pollution from Ships in force.

Regulation 21 – Periodical operation and inspection of watertight doors, etc. in passenger ships

- 1 Drills for the operating of watertight doors, sidescuttles, valves and closing mechanisms of scuppers, ash-chutes and rubbish-chutes shall take place weekly. In ships in which the voyage exceeds one week in duration a complete drill shall be held before leaving port, and others thereafter at least once a week during the voyage.
- 2 All watertight doors, both hinged and power operated, in watertight bulkheads, in use at sea, shall be operated daily.
- 3 The watertight doors and all mechanisms and indicators connected therewith, all valves, the closing of which is necessary to make a compartment watertight, and all valves the operation of which is necessary for damage control cross connections shall be periodically inspected at sea at least once a week.
- 4 A record of all drills and inspections required by this regulation shall be entered in the log-book with an explicit record of any defects which may be disclosed.

Regulation 22 – Prevention and control of water ingress, etc.

- 1 All watertight doors shall be kept closed during navigation except that they may be opened during navigation as specified in paragraphs 3 and 4. Watertight doors of a width of more than 1.2 m in machinery spaces as permitted by regulation 13.10 may only be opened in the circumstances detailed in that regulation. Any door which is opened in accordance with this paragraph shall be ready to be immediately closed.
- 2 Watertight doors located below the bulkhead deck having a maximum clear opening width of more than 1.2 m shall be kept closed when the ship is at sea, except for limited periods when absolutely necessary as determined by the Administration.
- 3 A watertight door may be opened during navigation to permit the passage of passengers or crew, or when work in the immediate vicinity of the door necessitates it being opened. The door must be immediately closed when transit through the door is complete or when the task which necessitated it being open is finished.
- 4 Certain watertight doors may be permitted to remain open during navigation only if considered absolutely necessary; that is, being open is determined essential to the safe and effective operation of the ship's machinery or to permit passengers normally unrestricted access throughout the passenger area. Such determination shall be made by the Administration only after careful consideration of the impact on ship operations and survivability. A watertight door permitted to remain thus open shall be clearly indicated in the ship's stability information and shall always be ready to be immediately closed.
- 5 Portable plates on bulkheads shall always be in place before the ship leaves port, and shall not be removed during navigation except in case of urgent necessity at the discretion of the master. The necessary precautions shall be taken in replacing them to ensure that the joints are watertight. Power-operated sliding watertight doors permitted in machinery spaces in accordance with regulation 13.10 shall be closed before the ship leaves port and shall remain closed during navigation except in case of urgent necessity at the discretion of the master.
- 6 Watertight doors fitted in watertight bulkheads dividing cargo between deck spaces in accordance with regulation 13.9.1 shall be closed before the voyage commences and shall be

kept closed during navigation; the time of opening such doors in port and of closing them before the ship leaves port shall be entered in the log-book.

- 7 Gangway, cargo and fuelling ports fitted below the bulkhead deck shall be effectively closed and secured watertight before the ship leaves port, and shall be kept closed during navigation.
- 8 The following doors, located above the bulkhead deck, shall be closed and locked before the ship proceeds on any voyage and shall remain closed and locked until the ship is at its next berth:
 - 8.1 cargo loading doors in the shell or the boundaries of enclosed superstructures;
 - 8.2 bow visors fitted in positions as indicated in paragraph 8.1;
 - 8.3 cargo loading doors in the collision bulkhead; and
 - 8.4 ramps forming an alternative closure to those defined in paragraphs 8.1 to 8.3 inclusive.
- 9 Provided that where a door cannot be opened or closed while the ship is at the berth such a door may be opened or left open while the ship approaches or draws away from the berth, but only so far as may be necessary to enable the door to be immediately operated. In any case, the inner bow door must be kept closed.
- 10 Notwithstanding the requirements of paragraphs 8.1 and 8.4, the Administration may authorize that particular doors can be opened at the discretion of the master, if necessary for the operation of the ship or the embarking and disembarking of passengers when the ship is at safe anchorage and provided that the safety of the ship is not impaired.
- 11 The master shall ensure that an effective system of supervision and reporting of the closing and opening of the doors referred to in paragraph 8.1 is implemented.
- 12 The master shall ensure, before the ship proceeds on any voyage, that an entry in the log-book is made of the time of the last closing of the doors specified in paragraph 13 and the time of any opening of particular doors in accordance with paragraph 14.
- 13 Hinged doors, portable plates, sidescuttles, gangway, cargo and bunkering ports and other openings, which are required by these regulations to be kept closed during navigation, shall be closed before the ship leaves port. The time of closing and the time of opening (if permissible under these regulations) shall be recorded in such log-book as may be prescribed by the Administration.
- 14 Where in a between-decks, the sills of any of the sidescuttles referred to in regulation 15.3.2 are below a line drawn parallel to the bulkhead deck at side and having its lowest point 1.4 m plus 2.5% of the breadth of the ship above the water when the ship departs from any port, all the sidescuttles in that between-decks shall be closed watertight and locked before the ship leaves port, and they shall not be opened before the ship arrives at the next port. In the application of this paragraph the appropriate allowance for fresh water may be made when applicable.
 - 14.1 The time of opening such sidescuttles in port and of closing and locking them before the ship leaves port shall be entered in such log-book as may be prescribed by the Administration.
 - 14.2 For any ship that has one or more sidescuttles so placed that the requirements of paragraph 3.3.1 would apply when it was floating at its deepest subdivision draught, the Administration may indicate the limiting mean draught at which these sidescuttles will have their sills above the line drawn parallel to the bulkhead deck at side, and having its lowest point 1.4 m plus 25% of the breadth of the ship above the waterline corresponding to the limiting mean draught, and at which it will therefore be permissible to depart from port without previously closing and locking them and to open them at sea on the responsibility of the master during the voyage to the next port. In tropical zones as defined in the International Convention on Load Lines in force, this limiting draught may be increased by 0.3 m.

- 15 Sidescuttles and their deadlights which will not be accessible during navigation shall be closed and secured before the ship leaves port.
- 16 If cargo is carried in such spaces, the sidescuttles and their deadlights shall be closed watertight and locked before the cargo is shipped and such closing and locking shall be recorded in such log-book as may be prescribed by the Administration.
- 17 When a rubbish-chute, etc. is not in use, both the cover and the valve required by regulation 15.10.2 shall be kept closed and secured.

Regulation 22-1 – Flooding detection systems for passenger ships carrying 36 or more persons constructed on or after 1 July 2010

- 1 A flooding detection system for watertight spaces below the bulkhead deck shall be provided based on the guidelines developed by the Organization.

Regulation 23 – Special requirements for ro-ro passenger ships

- 1 Special category spaces and ro-ro spaces shall be continuously patrolled or monitored by effective means, such as television surveillance, so that any movement of vehicles in adverse weather conditions and unauthorized access by passengers thereto can be detected whilst the ship is underway.
- 2 Documented operating procedures for closing and securing all shell doors, loading doors and other closing appliances which, if left open or not properly secured, could, in the opinion of the Administration, lead to flooding of a special category space or ro-ro space, shall be kept on board and posted at an appropriate place.
- 3 All accesses from the ro-ro deck and vehicle ramps that lead to spaces below the bulkhead deck shall be closed before the ship leaves the berth on any voyage and shall remain closed until the ship is at its next berth.
- 4 The master shall ensure that an effective system of supervision and reporting of the closing and opening of such accesses referred to in paragraph 3 is implemented.
- 5 The master shall ensure, before the ship leaves the berth on any voyage, that an entry in the log-book, as required by regulation 22.13, is made of the time of the last closing of the accesses.
- 6 Notwithstanding the requirements of paragraph 3, the Administration may permit some accesses to be opened during the voyage, but only for a period sufficient to permit through passage and, if required, for the essential working of the ship.
- 7 All transverse or longitudinal bulkheads which are taken into account as effective to confine the seawater accumulated on the ro-ro deck shall be in place and secured before the ship leaves the berth and remain in place and secured until the ship is at its next berth.
- 8 Notwithstanding the requirements of paragraph 7, the Administration may permit some accesses within such bulkheads to be opened during the voyage but only for sufficient time to permit through passage and, if required, for the essential working of the ship.
- 9 In all ro-ro passenger ships, the master or the designated officer shall ensure that, without the expressed consent of the master or the designated officer, no passengers are allowed access to an enclosed ro-ro deck when the ship is under way.

Regulation 24 – Prevention and control of water ingress, etc. in cargo ships

- 1 Openings in the shell plating below the deck limiting the vertical extent of damage shall be kept permanently closed while at sea.
- 2 Notwithstanding the requirements of paragraph 3, the Administration may authorize that particular doors may be opened at the discretion of the master, if necessary for the operation of the ship and provided that the safety of the ship is not impaired.

- 3 Watertight doors or ramps fitted internally to subdivide large cargo spaces shall be closed before the voyage commences and shall be kept closed during navigation; the time of opening such doors in port and of closing them before the ship leaves port shall be entered in the log-book.
- 4 The use of access doors and hatch covers intended to ensure the watertight integrity of internal openings shall be authorized by the officer of the watch.

Regulation 25 – Water level detectors on single hold cargo ships other than bulk carriers

- 1 Single hold cargo ships other than bulk carriers constructed before 1 January 2007 shall comply with the requirements of this regulation not later than 31 December 2009.
- 2 Ships having a length (L) of less than 80 m, or 100 m if constructed before 1 July 1998, and a single cargo hold below the freeboard deck or cargo holds below the freeboard deck which are not separated by at least one bulkhead made watertight up to that deck, shall be fitted in such space or spaces with water level detectors.⁴
- 3 The water level detectors required by paragraph 2 shall:
 - 3.1 give an audible and visual alarm at the navigation bridge when the water level above the inner bottom in the cargo hold reaches a height of not less than 0.3 m, and another when such level reaches not more than 15% of the mean depth of the cargo hold; and
 - 3.2 be fitted at the aft end of the hold, or above its lowest part where the inner bottom is not parallel to the designed waterline. Where webs or partial watertight bulkheads are fitted above the inner bottom, Administrations may require the fitting of additional detectors.
- 4 The water level detectors required by paragraph 2 need not be fitted in ships complying with regulation XII/12, or in ships having watertight side compartments each side of the cargo hold length extending vertically at least from inner bottom to freeboard deck.

⁴ Reference is made to "Performance standards for water level detectors on bulk carriers and single hold cargo ships other than bulk carriers", as adopted by MSC resolution MSC.188(79).

**Notice from the Danish Maritime Authority B –
The Construction and Equipment, etc. of Ships
Chapter B II-1 C**

**Construction– Structure, subdivision and stability, machinery and electrical
installations**

Regulation 26– General	1
Regulation 27 – Machinery	3
Regulation 28 – Means of going astern	3
Regulation 29 – Steering gear	4
Regulation 30 – Additional requirements for electric and electrohydraulic steering gear	8
Regulation 31 – Machinery controls	9
Regulation 32 – Steam boilers and boiler feed systems.....	11
Regulation 33 – Steam pipe systems.....	11
Regulation 34 – Air pressure systems.....	11
<i>Regulation 34-1 – Refrigerating plant</i>	<i>12</i>
Regulation 35 – Ventilating systems in machinery spaces	12
Regulation 35-1 – Bilge pumping arrangements	12
Regulation 36 – Protection against noise.....	16
Regulation 37 – Communication between navigation bridge and machinery space	16
Regulation 38 – Engineers' alarm	17
Regulation 39 – Location of emergency installations in passenger ships.....	17

Part C – Machinery installations

(Except where expressly provided otherwise part C applies to passenger ships and cargo ships)

Regulation 26– General

1. The machinery, boilers and other pressure vessels, associated piping systems and fittings shall be of a design and construction adequate for the service for which they are intended and shall be so installed and protected as to reduce to a minimum any danger to persons on board, due regard being paid to moving parts, hot surfaces and other hazards. The design shall have regard to materials used in construction, the purpose for which the equipment is intended, the working conditions to which it will be subjected and the environmental conditions on board¹⁾²⁾.

¹⁾ Reference is made to Chapter II-4 of these regulations, "Working spaces – Arrangement and Equipment."

²⁾ Refer to MSC/Circ. 834, Guidelines for engine-room lay. This Circular shall be used as general guidelines when engine rooms are designed and arranged. The specific regulations in the standards referred to in the Circular shall not necessarily be followed if general yard practice in the fields in question is sufficient. This shall, however, not apply to the regulations on noise reduction where reference is made to Notice A from the Danish Maritime Authority, chapter III B-1 on noise.

2. The Administration shall give special consideration to the reliability of single essential propulsion components and may require a separate source of propulsion power sufficient to give the ship a navigable speed, especially in the case of unconventional arrangements.
3. Means shall be provided whereby normal operation of propulsion machinery can be sustained or restored even though one of the essential auxiliaries becomes inoperative. Special consideration shall be given to the malfunctioning of:
 - 3.1. a generating set which serves as a main source of electrical power;
 - 3.2. the sources of steam supply;
 - 3.3. the boiler feedwater systems;
 - 3.4. the fuel oil supply systems for boilers³⁾
 - 3.5. the sources of lubricating oil pressure;
 - 3.6. the sources of water pressure;
 - 3.7. a condensate pump and the arrangements to maintain vacuum in condensers;
 - 3.8. the mechanical air supply for boilers;
 - 3.9. an air compressor and receiver for starting or control purposes;
 - 3.10. the hydraulic, pneumatic or electrical means for control in main propulsion machinery including controllable pitch propellers.

However, the Administration, having regard to overall safety considerations, may accept a partial reduction in propulsion capability from normal operation.

4. Means shall be provided to ensure that the machinery can be brought into operation from the dead ship condition without external aid.
5. All boilers, all parts of machinery, all steam, hydraulic, pneumatic and other systems and their associated fittings which are under internal pressure shall be subjected to appropriate tests including a pressure test before being put into service for the first time.
6. Main propulsion machinery and all auxiliary machinery essential to the propulsion and the safety of the ship shall, as fitted in the ship, be designed to operate when the ship is upright and when inclined at any angle of list up to and including 15° either way under static conditions and 22.5° under dynamic conditions (rolling) either way and simultaneously inclined dynamically (pitching) 7.5° by bow or stern. The Administration may permit deviation from these angles, taking into consideration the type, size and service conditions of the ship.
7. Provision shall be made to facilitate cleaning, inspection and maintenance of main propulsion and auxiliary machinery including boilers and pressure vessels.
8. Special consideration shall be given to the design, construction and installation of propulsion machinery systems so that any mode of their vibrations shall not cause undue stresses in this machinery in the normal operating ranges.
9. Non-metallic expansion joints in piping systems, if located in a system which penetrates the ship's side and both the penetration and the non-metallic expansion joint are located below the deepest load waterline, shall be inspected as part of the surveys prescribed in regulation I/10(a) and replaced as necessary, or at an interval recommended by the manufacturer.
10. Operating and maintenance instructions and engineering drawings for ship machinery and equipment essential to the safe operation of the ship shall be written in a language understandable

³⁾ Refer to MSC/Circ.647, Guidelines to minimize leakage from flammable liquid systems, as supplemented by MSC/ Circ. 851, Guidelines on engine-room oil fuel systems.

by those officers and crew members who are required to understand such information in the performance of their duties.

11. This paragraph applies only to *passenger ships, regardless of size, and cargo ships with a gross tonnage of 500 or more* constructed on or after 1 July 1998.

Location and arrangement of vent pipes for fuel oil service, settling and lubrication oil tanks shall be such that in the event of a broken vent pipe this shall not directly lead to the risk of ingress of seawater splashes or rainwater. Two fuel oil service tanks for each type of fuel used on board necessary for propulsion and vital systems or equivalent arrangements shall be provided on each new ship, with a capacity of at least 8 h at maximum continuous rating of the propulsion plant and normal operating load at sea of the generator plant⁴⁾.

12. *In addition to stipulations of this chapter, part E, regulations 46 to 53, with additional requirements for periodically unattended machinery spaces, ships shall, in order to acquire the designation periodically unattended machinery spaces, comply with the relevant regulations of a recognised classification society or be equipped in accordance with the guidance issued by the Danish Maritime Authority on navigation with periodically unmanned machinery spaces.*

Regulation 27 – Machinery

1. Where risk from over-speeding of machinery exists, means shall be provided to ensure that the safe speed is not exceeded.
2. Where main or auxiliary machinery including pressure vessels or any parts of such machinery are subject to internal pressure and may be subject to dangerous overpressure, means shall be provided where practicable to protect against such excessive pressure.
3. All gearing and every shaft and coupling used for transmission of power to machinery essential for the propulsion and safety of the ship or for the safety of persons on board shall be so designed and constructed that they will withstand the maximum working stresses to which they may be subjected in all service conditions, and due consideration shall be given to the type of engines by which they are driven or of which they form part.
4. Internal combustion engines of a cylinder diameter of 200 mm or a crankcase volume of 0.6 m³ and above shall be provided with crankcase explosion relief valves of a suitable type with sufficient relief area. The relief valves shall be arranged or provided with means to ensure that discharge from them is so directed as to minimize the possibility of injury to personnel.
5. Main turbine propulsion machinery and, where applicable, main internal combustion propulsion machinery and auxiliary machinery shall be provided with automatic shutoff arrangements in the case of failures such as lubricating oil supply failure which could lead rapidly to complete breakdown, serious damage or explosion.

The Administration may permit provisions for overriding automatic shutoff devices.

Regulation 28 – Means of going astern⁵⁾

1. Sufficient power for going astern shall be provided to secure proper control of the ship in all normal circumstances.

⁴⁾ Refer to regulation II-2/4.2, "Arrangements for oil fuel, lubricating oil and other flammable oils".

⁵⁾ Refer to the Recommendation on the provision and the display of manoeuvring information on board ships (resolution A.601(15)), the Interim standards for ship manoeuvrability (resolution A.751(18)), and the Explanatory notes to the interim standards for ship manoeuvrability (MSC/Circ.1053).

2. The ability of the machinery to reverse the direction of thrust of the propeller in sufficient time, and so to bring the ship to rest within a reasonable distance from maximum ahead service speed, shall be demonstrated and recorded.⁶⁾
3. The stopping times, ship headings and distances recorded on trials, together with the results of trials to determine the ability of ships having multiple propellers to navigate and manoeuvre with one or more propellers inoperative, shall be available on board for the use of the master or designated personnel.⁷⁾
4. Where the ship is provided with supplementary means for manoeuvring or stopping, the effectiveness of such means shall be demonstrated and recorded as referred to in paragraphs 2 and 3.

Regulation 29 – Steering gear⁸⁾

1. Unless expressly provided otherwise, every ship shall be provided with a main steering gear and an auxiliary steering gear to the satisfaction of the Administration. The main steering gear and the auxiliary steering gear shall be so arranged that the failure of one of them will not render the other one inoperative.
2.
 - 2.1. All the steering gear components and the rudder stock shall be of sound and reliable construction to the satisfaction of the Administration. Special consideration shall be given to the suitability of any essential component which is not duplicated. Any such essential component shall, where appropriate, utilize antifriction bearings such as ball-bearings, roller-bearings or sleeve bearings which shall be permanently lubricated or provided with lubrication fittings.
 - 2.2. The design pressure for calculations to determine the scantlings of piping and other steering gear components subjected to internal hydraulic pressure shall be at least 1.25 times the maximum working pressure to be expected under the operational conditions specified in paragraph 3.2, taking into account any pressure which may exist in the low-pressure side of the system. At the discretion of the Administration, fatigue criteria shall be applied for the design of piping and components, taking into account pulsating pressures due to dynamic loads.
 - 2.3. Relief valves shall be fitted to any part of the hydraulic system which can be isolated and in which pressure can be generated from the power source or from external forces. The setting of the relief valves shall not exceed the design pressure. The valves shall be of adequate size and so arranged as to avoid an undue rise in pressure above the design pressure.
3. The main steering gear and rudder stock shall be:
 - 3.1. of adequate strength and capable of steering the ship at maximum ahead service speed which shall be demonstrated;
 - 3.2. capable of putting the rudder over from 35° on one side to 35° on the other side with the ship at its deepest seagoing draught and running ahead at maximum ahead service speed and,

⁶⁾ Cf. Recommendation on information to be included in the manoeuvring booklets.

⁷⁾ Cf. Recommendation on information to be included in the manoeuvring booklets.

⁸⁾ Refer to resolution A.415(XI) on improved steering gear standards for passenger and cargo ships and resolution A.416 (XI) on examination of steering gears on existing tankers.

- under the same conditions, from 35° on either side to 30° on the other side in not more than 28 s;
- 3.3. operated by power where necessary to meet the requirements of paragraph 3.2 and in any case when the Administration requires a rudder stock of over 120 mm diameter in way of the tiller, excluding strengthening for navigation in ice; and
 - 3.4. so designed that they will not be damaged at maximum astern speed; however, this design requirement need not be proved by trials at maximum astern speed and maximum rudder angle.
4. The auxiliary steering gear shall be:
 - 4.1. of adequate strength and capable of steering the ship at navigable speed and of being brought speedily into action in an emergency;
 - 4.2. capable of putting the rudder over from 15° on one side to 15° on the other side in not more than 60 s with the ship at its deepest seagoing draught and running ahead at one half of the maximum ahead service speed or 7 knots, whichever is the greater; and
 - 4.3. operated by power where necessary to meet the requirements of paragraph 4.2 and in any case when the Administration requires a rudder stock of over 230 mm diameter in way of the tiller, excluding strengthening for navigation in ice.
 5. Main and auxiliary steering gear power units shall be:
 - 5.1. arranged to restart automatically when power is restored after a power failure; and
 - 5.2. capable of being brought into operation from a position on the navigation bridge. In the event of a power failure to any one of the steering gear power units, an audible and visual alarm shall be given on the navigation bridge.
 6.
 - 6.1. Where the main steering gear comprises two or more identical power units, an auxiliary steering gear need not be fitted, provided that:
 - 6.1.1. in a passenger ship, the main steering gear is capable of operating the rudder as required by paragraph 3.2 while any one of the power units is out of operation;
 - 6.1.2. in a cargo ship, the main steering gear is capable of operating the rudder as required by paragraph 3.2 while operating with all power units;
 - 6.1.3. the main steering gear is so arranged that after a single failure in its piping system or in one of the power units the defect can be isolated so that steering capability can be maintained or speedily regained.
 - 6.2. The Administration may, until 1 September 1986, accept the fitting of a steering gear which has a proven record of reliability but does not comply with the requirements of paragraph 6.1.3 for a hydraulic system.
 - 6.3. Steering gears, other than of the hydraulic type, shall achieve standards equivalent to the requirements of this paragraph to the satisfaction of the Administration.
 7. Steering gear control shall be provided:
 - 7.1. for the main steering gear, both on the navigation bridge and in the steering gear compartment;
 - 7.2. where the main steering gear is arranged in accordance with paragraph 6, by two independent control systems, both operable from the navigation bridge. This does not require duplication of the steering wheel or steering lever. Where the control system consists of a hydraulic telemotor, a second independent system need not be fitted, except in a tanker, chemical tanker or gas carrier of 10,000 gross tonnage and upwards;

- 7.3. for the auxiliary steering gear, in the steering gear compartment and, if power-operated, it shall also be operable from the navigation bridge and shall be independent of the control system for the main steering gear.
8. Any main and auxiliary steering gear control system operable from the navigation bridge shall comply with the following:
 - 8.1. if electric, it shall be served by its own separate circuit supplied from a steering gear power circuit from a point within the steering gear compartment, or directly from switchboard busbars supplying that steering gear power circuit at a point on the switchboard adjacent to the supply to the steering gear power circuit;
 - 8.2. means shall be provided in the steering gear compartment for disconnecting any control system operable from the navigation bridge from the steering gear it serves;
 - 8.3. the system shall be capable of being brought into operation from a position on the navigation bridge;
 - 8.4. in the event of a failure of electrical power supply to the control system, an audible and visual alarm shall be given on the navigation bridge; and
 - 8.5. short circuit protection only shall be provided for steering gear control supply circuits.
9. The electrical power circuits and the steering gear control systems with their associated components, cables and pipes required by this regulation and by regulation 30 shall be separated as far as is practicable throughout their length.
10. A means of communication shall be provided between the navigation bridge and the steering gear compartment.
11. The angular position of the rudder shall:
 - 11.1. if the main steering gear is power operated, be indicated on the navigation bridge. The rudder angle indication shall be independent of the steering gear control system;
 - 11.2. be recognizable in the steering gear compartment.
12. Hydraulic power-operated steering gear shall be provided with the following:
 - 12.1. arrangements to maintain the cleanliness of the hydraulic fluid taking into consideration the type and design of the hydraulic system;
 - 12.2. a low-level alarm for each hydraulic fluid reservoir to give the earliest practicable indication of hydraulic fluid leakage. Audible and visual alarms shall be given on the navigation bridge and in the machinery space where they can be readily observed; and
 - 12.3. a fixed storage tank having sufficient capacity to recharge at least one power actuating system including the reservoir, where the main steering gear is required to be power-operated. The storage tank shall be permanently connected by piping in such a manner that the hydraulic systems can be readily recharged from a position within the steering gear compartment and shall be provided with a contents gauge.
13. The steering gear compartments shall be:
 - 13.1. readily accessible and, as far as practicable, separated from machinery spaces; and
 - 13.2. provided with suitable arrangements to ensure working access to steering gear machinery and controls. These arrangements shall include handrails and gratings or other non-slip surfaces to ensure suitable working conditions in the event of hydraulic fluid leakage.
14. Where the rudder stock is required to be over 230 mm diameter in way of the tiller, excluding strengthening for navigation in ice, an alternative power supply, sufficient at least to supply the steering gear power unit which complies with the requirements of paragraph 4.2 and also its associated control system and the rudder angle indicator, shall be provided automatically, within 45

- s, either from the emergency source of electrical power or from an independent source of power located in the steering gear compartment. This independent source of power shall be used only for this purpose. In every ship of 10,000 gross tonnage and upwards, the alternative power supply shall have a capacity for at least 30 min of continuous operation and in any other ship for at least 10 min.
15. In every tanker, chemical tanker or gas carrier of 10,000 gross tonnage and upwards and in every other ship of 70,000 gross tonnage and upwards, the main steering gear shall comprise two or more identical power units complying with the provisions of paragraph 6.
 16. Every tanker, chemical tanker or gas carrier of 10,000 gross tonnage and upwards shall, subject to paragraph 17, comply with the following:
 - 16.1. the main steering gear shall be so arranged that in the event of loss of steering capability due to a single failure in any part of one of the power actuating systems of the main steering gear, excluding the tiller, quadrant or components serving the same purpose, or seizure of the rudder actuators, steering capability shall be regained in not more than 45 s after the loss of one power actuating system;
 - 16.2. the main steering gear shall comprise either:
 - 16.2.1. two independent and separate power actuating systems, each capable of meeting the requirements of paragraph 3.2; or
 - 16.2.2. at least two identical power actuating systems which, acting simultaneously in normal operation, shall be capable of meeting the requirements of paragraph 3.2. Where necessary to comply with this requirement, interconnection of hydraulic power actuating systems shall be provided. Loss of hydraulic fluid from one system shall be capable of being detected and the defective system automatically isolated so that the other actuating system or systems shall remain fully operational;
 - 16.3. steering gears other than of the hydraulic type shall achieve equivalent standards.
 17. For tankers, chemical tankers or gas carriers of 10,000 gross tonnage and upwards, but of less than 100,000 tonnes deadweight, solutions other than those set out in paragraph 16, which need not apply the single failure criterion to the rudder actuator or actuators, may be permitted provided that an equivalent safety standard is achieved and that:
 - 17.1. following loss of steering capability due to a single failure of any part of the piping system or in one of the power units, steering capability shall be regained within 45 s; and
 - 17.2. where the steering gear includes only a single rudder actuator, special consideration is given to stress analysis for the design including fatigue analysis and fracture mechanics analysis, as appropriate, to the material used, to the installation of sealing arrangements and to testing and inspection and to the provision of effective maintenance. In consideration of the foregoing, the Administration shall adopt regulations which include the provisions of the Guidelines for acceptance of non-duplicated rudder actuators for tankers, chemical tankers and gas carriers of 10,000 gross tonnage and above but less than 100,000 tonnes deadweight, adopted by the Organization.⁹⁾
 18. For a tanker, chemical tanker or gas carrier of 10,000 gross tonnage and upwards, but less than 70,000 tonnes deadweight, the Administration may, until 1 September 1986, accept a steering gear system with a proven record of reliability which does not comply with the single failure criterion required for a hydraulic system in paragraph 16.

9) Adopted by the Organization by resolution A.467(XII).

19. Every tanker, chemical tanker or gas carrier of 10,000 gross tonnage and upwards, constructed before 1 September 1984, shall comply, not later than 1 September 1986, with the following:
 - 19.1. the requirements of paragraphs 7.1, 8.2, 8.4, 10, 11, 12.2, 12.3 and 13.2;
 - 19.2. two independent steering gear control systems shall be provided each of which can be operated from the navigation bridge. This does not require duplication of the steering wheel or steering lever;
 - 19.3. if the steering gear control system in operation fails, the second system shall be capable of being brought into immediate operation from the navigation bridge; and
 - 19.4. each steering gear control system, if electric, shall be served by its own separate circuit supplied from the steering gear power circuit or directly from switchboard busbars supplying that steering gear power circuit at a point on the switchboard adjacent to the supply to the steering gear power circuit.
20. In addition to the requirements of paragraph 19, in every tanker, chemical tanker or gas carrier of 40,000 gross tonnage and upwards, constructed before 1 September 1984, the steering gear shall, not later than 1 September 1988, be so arranged that, in the event of a single failure of the piping or of one of the power units, steering capability can be maintained or the rudder movement can be limited so that steering capability can be speedily regained. This shall be achieved by:
 - 20.1. an independent means of restraining the rudder; or
 - 20.2. fast-acting valves which may be manually operated to isolate the actuator or actuators from the external hydraulic piping together with a means of directly refilling the actuators by a fixed independent power-operated pump and piping system; or
 - 20.3. an arrangement such that, where hydraulic power systems are interconnected, loss of hydraulic fluid from one system shall be detected and the defective system isolated either automatically or from the navigation bridge so that the other system remains fully operational.

Regulation 30 – Additional requirements for electric and electrohydraulic steering gear

1. Means for indicating that the motors of electric and electrohydraulic steering gear are running shall be installed on the navigation bridge and at a suitable main machinery control position.
2. Each electric or electrohydraulic steering gear comprising one or more power units shall be served by at least two exclusive circuits fed directly from the main switchboard; however, one of the circuits may be supplied through the emergency switchboard. An auxiliary electric or electrohydraulic steering gear associated with a main electric or electrohydraulic steering gear may be connected to one of the circuits supplying this main steering gear. The circuits supplying an electric or electrohydraulic steering gear shall have adequate rating for supplying all motors which can be simultaneously connected to them and may be required to operate simultaneously.
3. Short circuit protection and an overload alarm shall be provided for such circuits and motors. Protection against excess current, including starting current, if provided, shall be for not less than twice the full load current of the motor or circuit so protected, and shall be arranged to permit the passage of the appropriate starting currents. Where a three-phase supply is used an alarm shall be provided that will indicate failure of any one of the supply phases. The alarms required in this paragraph shall be both audible and visual and shall be situated in a conspicuous position in the main machinery space or control room from which the main machinery is normally controlled and as may be required by regulation 51.

4. When in a ship of less than 1,600 gross tonnage an auxiliary steering gear which is required by regulation 29.4.3 to be operated by power is not electrically powered or is powered by an electric motor primarily intended for other services, the main steering gear may be fed by one circuit from the main switchboard. Where such an electric motor primarily intended for other services is arranged to power such an auxiliary steering gear, the requirement of paragraph 3 may be waived by the Administration if satisfied with the protection arrangement together with the requirements of regulation 29.5.1 and .2 and 29.7.3 applicable to auxiliary steering gear.

Regulation 31 – Machinery controls

1. Main and auxiliary machinery essential for the propulsion and safety of the ship shall be provided with effective means for its operation and control.
2. Where remote control of propulsion machinery from the navigation bridge is provided and the machinery spaces are intended to be manned, the following shall apply:
 - 2.1. the speed, direction of thrust and, if applicable, the pitch of the propeller shall be fully controllable from the navigation bridge under all sailing conditions, including manoeuvring;
 - 2.2. the remote control shall be performed, for each independent propeller, by a control device so designed and constructed that its operation does not require particular attention to the operational details of the machinery. Where multiple propellers are designed to operate simultaneously, they may be controlled by one control device;
 - 2.3. the main propulsion machinery shall be provided with an emergency stopping device on the navigation bridge which shall be independent of the navigation bridge control system;
 - 2.4. propulsion machinery orders from the navigation bridge shall be indicated in the main machinery control room or at the manoeuvring platform as appropriate;
 - 2.5. remote control of the propulsion machinery shall be possible only from one location at a time; at such locations interconnected control positions are permitted. At each location there shall be an indicator showing which location is in control of the propulsion machinery. The transfer of control between the navigation bridge and machinery spaces shall be possible only in the main machinery space or the main machinery control room. This system shall include means to prevent the propelling thrust from altering significantly when transferring control from one location to another;
 - 2.6. it shall be possible to control the propulsion machinery locally, even in the case of failure in any part of the remote control system;
 - 2.7. the design of the remote control system shall be such that in case of its failure an alarm will be given. Unless the Administration considers it impracticable the preset speed and direction of thrust of the propellers shall be maintained until local control is in operation;
 - 2.8. indicators shall be fitted on the navigation bridge for:
 - 2.8.1. propeller speed and direction of rotation in the case of fixed pitch propellers;
 - 2.8.2. propeller speed and pitch position in the case of controllable pitch propellers;
 - 2.9. an alarm shall be provided on the navigation bridge and in the machinery space to indicate low starting air pressure which shall be set at a level to permit further main engine starting operations. If the remote control system of the propulsion machinery is designed for automatic starting, the number of automatic consecutive attempts which fail to produce a start shall be limited in order to safeguard sufficient starting air pressure for starting locally;

- 2.10. automation systems shall be designed in a manner which ensures that threshold warning of impending or imminent slowdown or shutdown of the propulsion system is given to the officer in charge of the navigational watch in time to assess navigational circumstances in an emergency. In particular, the systems shall control, monitor, report, alert and take safety action to slow down or stop propulsion while providing the officer in charge of the navigational watch an opportunity to manually intervene, except for those cases where manual intervention will result in total failure of the engine and/or propulsion equipment within a short time, for example in the case of over-speed.
3. Where the main propulsion and associated machinery, including sources of main electrical supply, are provided with various degrees of automatic or remote control and are under continuous manual supervision from a control room the arrangements and controls shall be so designed, equipped and installed that the machinery operation will be as safe and effective as if it were under direct supervision; for this purpose regulations 46 to 50 shall apply as appropriate. Particular consideration shall be given to protect such spaces against fire and flooding.
 4. In general, automatic starting, operational and control systems shall include provisions for manually overriding the automatic controls. Failure of any part of such systems shall not prevent the use of the manual override.
 5. Ships constructed on or after 1 July 1998 *and cargo ships with a gross tonnage below 500 constructed on or after 1 January 2002* shall comply with the requirements of paragraphs 1 to 4, as amended, as follows:
 - 5.1. paragraph 1 is replaced by the following:

"1 Main and auxiliary machinery essential for the propulsion, control and safety of the ship shall be provided with effective means for its operation and control. All control systems essential for the propulsion, control and safety of the ship shall be independent or designed such that failure of one system does not degrade the performance of another system.";
 - 5.2. in the second and third lines of paragraph 2, the words "and the machinery spaces are intended to be manned" are deleted;
 - 5.3. the first sentence of paragraph 2.2 is replaced by the following:

".2 the control shall be performed by a single control device for each independent propeller, with automatic performance of all associated services, including, where necessary, means of preventing overload of the propulsion machinery.";
 - 5.4. paragraph 2.4 is replaced by the

".4 propulsion machinery orders from the navigation bridge shall be indicated in the main machinery control room and at the manoeuvring platform;";
 - 5.5. a new sentence is added at the end of paragraph 2.6 to read as follows:

"It shall also be possible to control the auxiliary machinery, essential for the propulsion and safety of the ship, at or near the machinery concerned;" and
 - 5.6. paragraphs 2.8, 2.8.1 and 2.8.2 are replaced by the following:

".8 indicators shall be fitted on the navigation bridge, the main machinery control room and at the manoeuvring platform, for:

 - .8.1 propeller speed and direction of rotation in the case of fixed pitch propellers; and
 - .8.2 propeller speed and pitch position in the case of controllable pitch propellers;".
 6. Ships constructed on or after 1 July 2004 *and cargo ships with a gross tonnage below 500 constructed on or after 1 January 2004* shall comply with the requirements of paragraphs 1 to 5, as amended, as follows:

6.1. The following subparagraph .10 is added to paragraph 2 of this regulation:

“.10 automation systems shall be designed in a manner which ensure that threshold warning of impending or imminent slowdown or shutdown of the propulsion system is given to the officer in charge of the navigational watch in time to assess navigational circumstances in an emergency. In particular, the systems shall control, monitor, report, alert and take safety action slow down or stop propulsion while providing the officer in charge of navigational watch an opportunity to manually intervene, except for those cases where manual intervention will result in total failure of the engine and/or propulsion equipment within a short time, for example in case of over-speed.”

Regulation 32 – Steam boilers and boiler feed systems

1. Every steam boiler and every unfired steam generator shall be provided with not less than two safety valves of adequate capacity. However, having regard to the output or any other features of any boiler or unfired steam generator, the Administration may permit only one safety valve to be fitted if it is satisfied that adequate protection against overpressure is thereby provided.
2. Each oil-fired boiler which is intended to operate without manual supervision shall have safety arrangements which shut off the fuel supply and give an alarm in the case of low water level, air supply failure or flame failure.
3. Water tube boilers serving turbine propulsion machinery shall be fitted with a high-water-level alarm.
4. Every steam generating system which provides services essential for the safety of the ship, or which could be rendered dangerous by the failure of its feedwater supply, shall be provided with not less than two separate feedwater systems from and including the feed pumps, noting that a single penetration of the steam drum is acceptable. Unless overpressure is prevented by the pump characteristics, means shall be provided which will prevent overpressure in any part of the systems.
5. Boilers shall be provided with means to supervise and control the quality of the feedwater. Suitable arrangements shall be provided to preclude, as far as practicable, the entry of oil or other contaminants which may adversely affect the boiler.
6. Every boiler essential for the safety of the ship and designed to contain water at a specified level shall be provided with at least two means for indicating its water level, at least one of which shall be a direct reading gauge glass.

Regulation 33 – Steam pipe systems

1. Every steam pipe and every fitting connected thereto through which steam may pass shall be so designed, constructed and installed as to withstand the maximum working stresses to which it may be subjected.
2. Means shall be provided for draining every steam pipe in which dangerous water hammer action might otherwise occur.
3. If a steam pipe or fitting may receive steam from any source at a higher pressure than that for which it is designed a suitable reducing valve, relief valve and pressure gauge shall be fitted.

Regulation 34 – Air pressure systems

1. In every ship means shall be provided to prevent overpressure in any part of compressed air systems and wherever water jackets or casings of air compressors and coolers might be subjected to

dangerous overpressure due to leakage into them from air pressure parts. Suitable pressure relief arrangements shall be provided for all systems.

2. The main starting air arrangements for main propulsion internal combustion engines shall be adequately protected against the effects of backfiring and internal explosion in the starting air pipes.
3. All discharge pipes from starting air compressors shall lead directly to the starting air receivers, and all starting pipes from the air receivers to main or auxiliary engines shall be entirely separate from the compressor discharge pipe system.
4. Provision shall be made to reduce to a minimum the entry of oil into the air pressure systems and to drain these systems.

Regulation 34-1 – Refrigerating plant

Reference is made to the national provisions in chapter B II-1 N(1).

Regulation 35 – Ventilating systems in machinery spaces

Machinery spaces of category A shall be adequately ventilated so as to ensure that when machinery or boilers therein are operating at full power in all weather conditions including heavy weather, an adequate supply of air is maintained to the spaces for the safety and comfort of personnel and the operation of the machinery. Any other machinery space shall be adequately ventilated appropriate for the purpose of that machinery space.

Regulation 35-1 – Bilge pumping arrangements

1. This regulation applies to ships constructed on or after 1 January 2009.
2. Passenger ships and cargo ships
 - 2.1 An efficient bilge pumping system shall be provided, capable of pumping from and draining any watertight compartment other than a space permanently appropriated for the carriage of fresh water, water ballast, oil fuel or liquid cargo and for which other efficient means of pumping are provided, under all practical conditions. Efficient means shall be provided for draining water from insulated holds.
 - 2.2 Sanitary, ballast and general service pumps may be accepted as independent power bilge pumps if fitted with the necessary connections to the bilge pumping system.
 - 2.3 All bilge pipes used in or under coal bunkers or fuel storage tanks or in boiler or machinery spaces, including spaces in which oil-settling tanks or oil fuel pumping units are situated, shall be of steel or other suitable material.
 - 2.4 The arrangement of the bilge and ballast pumping system shall be such as to prevent the possibility of water passing from the sea and from water ballast spaces into the cargo and machinery spaces, or from one compartment to another. Provision shall be made to prevent any deep tank having bilge and ballast connections being inadvertently flooded from the sea when containing cargo, or being discharged through a bilge pump when containing water ballast.
 - 2.5 All distribution boxes and manually operated valves in connection with the bilge pumping arrangements shall be in positions which are accessible under ordinary circumstances.
 - 2.6 Provision shall be made for the drainage of enclosed cargo spaces situated on the bulkhead deck of a passenger ship and on the freeboard deck of a cargo ship, provided that the Administration may permit the means of drainage to be dispensed with in any particular

compartment of any ship or class of ship if it is satisfied that by reason of size or internal subdivision of those spaces the safety of the ship is not thereby impaired.

- 2.6.1 Where the freeboard to the bulkhead deck or the freeboard deck, respectively, is such that the deck edge is immersed when the ship heels more than 5°, the drainage shall be by means of a sufficient number of scuppers of suitable size discharging directly overboard, fitted in accordance with the requirements of regulation 15 in the case of a passenger ship and the requirements for scuppers, inlets and discharges of the International Convention on Load Lines in force in the case of a cargo ship.
- 2.6.2 Where the freeboard is such that the edge of the bulkhead deck or the edge of the freeboard deck, respectively, is immersed when the ship heels 5° or less, the drainage of the enclosed cargo spaces on the bulkhead deck or on the freeboard deck, respectively, shall be led to a suitable space, or spaces, of adequate capacity, having a high water level alarm and provided with suitable arrangements for discharge overboard. In addition it shall be ensured that:
- .1 the number, size and disposition of the scuppers are such as to prevent unreasonable accumulation of free water;
 - .2 the pumping arrangements required by this regulation for passenger ships or cargo ships, as applicable, take account of the requirements for any fixed pressure water-spraying fire extinguishing system;
 - .3 water contaminated with petrol or other dangerous substances is not drained to machinery spaces or other spaces where sources of ignition may be present; and
 - .4 where the enclosed cargo space is protected by a carbon dioxide fire extinguishing system the deck scuppers are fitted with means to prevent the escape of the smothering gas.
- 2.6.3 *The drainage from car decks/ro-ro decks shall be of such capacity that two-thirds of the scuppers, freeing ports, etc. on the starboard or port side shall be capable of draining off a quantity of water originating from sprinkler pumps and firepumps, taking into account a list of about 1° for ships with a breadth of above 20 metres and about 1.5° to 2° for ships with a breadth below 20 metres and trim forward or aft of about 0.5° A water column of maximum 100 mm above the scuppers/bilge wells may be accepted.*
- 2.6.4 *Scuppers on the car deck shall be provided, over the outlet grate, with a removable grill with vertical bars to prevent large obstacles from blocking the drain. The grill may be placed obliquely against the side of the ship. The grill shall have a height of minimum 1 meter above the deck and shall have a free flow area of minimum 0.4 m², while the distance between the individual bars shall be maximum 25 mm.*

3 Passenger ships

- 3.1 The bilge pumping system required by paragraph 2.1 shall be capable of operation under all practicable conditions after a casualty whether the ship is upright or listed. For this purpose wing suction shall generally be fitted except in narrow compartments at the end of the ship where one suction may be sufficient. In compartments of unusual form, additional suction may be required. Arrangements shall be made whereby water in the compartment may find its way to the suction pipes. *The mouth of the suction pipe shall preferably be placed in bilge wells. Each mouth shall be provided with a filter placed as close to the end of the suction pipe as possible; it shall, however, be easily accessible for cleaning.* Where, for particular compartments, the Administration is satisfied that the provision of drainage may be undesirable, it may allow such provision to be dispensed with if calculations made in

accordance with the conditions laid down in regulations 7 and 8 show that the survival capability of the ship will not be impaired.

- 3.2 At least three power pumps shall be fitted connected to the bilge main, one of which may be driven by the propulsion machinery. Where the bilge pump numeral is 30 or more, one additional independent power pump shall be provided.

The bilge pump numeral shall be calculated as follows:

when P_1 is greater than P :

$$\text{bilge pump numeral} = 72 \cdot \left[\frac{M + 2P_1}{V + P_1 - P} \right]$$

$$\text{in other cases: bilge pump numeral} = 72 \cdot \left[\frac{M + 2P}{V} \right]$$

where:

L = the length of the ship (metres), as defined in regulation 2;

M = the volume of the machinery space (cubic metres), as defined in regulation 2, that is below the bulkhead deck; with the addition thereto of the volume of any permanent oil fuel bunkers which may be situated above the inner bottom and forward of, or abaft, the machinery space;

P = the whole volume of the passenger and crew spaces below the bulkhead deck (cubic metres), which are provided for the accommodation and use of passengers and crew, excluding baggage, store, provision and mail rooms;

V = the whole volume of the ship below the bulkhead deck (cubic metres);

$P_1 = KN$,

where:

N = the number of passengers for which the ship is to be certified; and

$K = 0.056L$

However, where the value of KN is greater than the sum of P and the whole volume of the actual passenger spaces above the bulkhead deck, the figure to be taken as P_1 is that sum or two-thirds KN , whichever is the greater.

- 3.3 Where practicable, the power bilge pumps shall be placed in separate watertight compartments and so arranged or situated that these compartments will not be flooded by the same damage. If the main propulsion machinery, auxiliary machinery and boilers are in two or more watertight compartments, the pumps available for bilge service shall be distributed as far as is possible throughout these compartments.
- 3.4 On a ship of 91.5 m in length and upwards or having a bilge pump numeral, calculated in accordance with paragraph 3.2, of 30 or more, the arrangements shall be such that at least one power bilge pump shall be available for use in all flooding conditions which the ship is required to withstand, as follows:
- .1 one of the required bilge pumps shall be an emergency pump of a reliable submersible type having a source of power situated above the bulkhead deck; or

- .2 the bilge pumps and their sources of power shall be so distributed throughout the length of the ship that at least one pump in an undamaged compartment will be available.
- 3.5 With the exception of additional pumps which may be provided for peak compartments only, each required bilge pump shall be so arranged as to draw water from any space required to be drained by paragraph 2.1.
- 3.6 Each power bilge pump shall be capable of pumping water through the required main bilge pipe at a speed of not less than 2 m/s. Independent power bilge pumps situated in machinery spaces shall have direct suctions from these spaces, except that not more than two such suctions shall be required in any one space. Where two or more such suctions are provided, there shall be at least one on each side of the ship. The Administration may require independent power bilge pumps situated in other spaces to have separate direct suctions. Direct suctions shall be suitably arranged and those in a machinery space shall be of a diameter not less than that required for the bilge main.
- 3.7.1 In addition to the direct bilge suction or suctions required by paragraph 3.6, a direct suction from the main circulating pump leading to the drainage level of the machinery space and fitted with a non-return valve shall be provided in the machinery space. The diameter of this direct suction pipe shall be at least two thirds of the diameter of the pump inlet in the case of steamships, and of the same diameter as the pump inlet in the case of motorships.
- 3.7.2 Where in the opinion of the Administration the main circulating pump is not suitable for this purpose, a direct emergency bilge suction shall be led from the largest available independent power driven pump to the drainage level of the machinery space; the suction shall be of the same diameter as the main inlet of the pump used. The capacity of the pump so connected shall exceed that of a required bilge pump by an amount deemed satisfactory by the Administration.
- 3.7.3 The spindles of the sea inlet and direct suction valves shall extend well above the engine-room platform.
- 3.8 All bilge suction piping up to the connection to the pumps shall be independent of other piping.
- 3.9 The diameter d of the bilge main shall be calculated according to the following formula. However, the actual internal diameter of the bilge main may be rounded off to the nearest standard size acceptable to the Administration:

$$d = 25 + 1,68 \sqrt{L(B + D)}$$

where:

d is the internal diameter of the bilge main (millimetres);

L and B are the length and the breadth of the ship (metres) as defined in regulation 2; and

D is the moulded depth of the ship to the bulkhead deck (metres) provided that, in a ship having an enclosed cargo space on the bulkhead deck which is internally drained in accordance with the requirements of paragraph 2.6.2 and which extends for the full length of the ship, D shall be measured to the next deck above the bulkhead deck. Where the enclosed cargo spaces cover a lesser length, D shall be taken as the moulded depth to the bulkhead deck plus lh/L where l and h are the aggregate length and height respectively of the enclosed

cargo spaces (metres). The diameter of the bilge branch pipes shall meet the requirements of the Administration.

- 3.10 Provision shall be made to prevent the compartment served by any bilge suction pipe being flooded in the event of the pipe being severed or otherwise damaged by collision or grounding in any other compartment. For this purpose, where the pipe is at any part situated nearer the side of the ship than one fifth of the breadth of the ship (as defined in regulation 2 and measured at right angles to the centreline at the level of the deepest subdivision load line), or is in a duct keel, a non-return valve shall be fitted to the pipe in the compartment containing the open end.
- 3.11 Distribution boxes, cocks and valves in connection with the bilge pumping system shall be so arranged that, in the event of flooding, one of the bilge pumps may be operative on any compartment; in addition, damage to a pump or its pipe connecting to the bilge main outboard of a line drawn at one fifth of the breadth of the ship shall not put the bilge system out of action. If there is only one system of pipes common to all the pumps, the necessary valves for controlling the bilge suction must be capable of being operated from above the bulkhead deck. Where in addition to the main bilge pumping system an emergency bilge pumping system is provided, it shall be independent of the main system and so arranged that a pump is capable of operating on any compartment under flooding condition as specified in paragraph 3.1; in that case only the valves necessary for the operation of the emergency system need be capable of being operated from above the bulkhead deck.
- 3.12 All cocks and valves referred to in paragraph 3.11 which can be operated from above the bulkhead deck shall have their controls at their place of operation clearly marked and shall be provided with means to indicate whether they are open or closed.

4 Cargo ships

At least two power pumps connected to the main bilge system shall be provided, one of which may be driven by the propulsion machinery. If the Administration is satisfied that the safety of the ship is not impaired, bilge pumping arrangements may be dispensed with in particular compartments.

Regulation 36 – Protection against noise¹⁰⁾

Measures shall be taken to reduce machinery noise in machinery spaces to acceptable levels as determined by the Administration. If this noise cannot be sufficiently reduced the source of excessive noise shall be suitably insulated or isolated or a refuge from noise shall be provided if the space is required to be manned. Ear protectors shall be provided for personnel required to enter such spaces, if necessary.

Regulation 37 – Communication between navigation bridge and machinery space

1. At least two independent means shall be provided for communicating orders from the navigation bridge to the position in the machinery space or in the control room from which the engines are normally controlled: one of these shall be an engine-room telegraph which provides visual indication of the orders and responses both in the machinery space and on the navigation bridge. Appropriate means of communication shall be provided to any other positions from which the engines may be controlled.

¹⁰⁾ Refer to the Code on Noise Levels on Board Ships adopted by the Organization by resolution A.468(XII) and Notice A of the Danish Maritime Authority, chapter III B-1 on noise.

2. For ships constructed on or after 1 October 1994 the following requirements apply in lieu of the provisions of paragraph 1:
At least two independent means shall be provided for communicating orders from the navigation bridge to the position in the machinery space or in the control room from which the speed and direction of thrust of the propellers are normally controlled; one of these shall be an engine-room telegraph which provides visual indication of the orders and responses both in the machinery spaces and on the navigation bridge. Appropriate means of communication shall be provided from the navigation bridge and the engine-room to any other position from which the speed or direction of thrust of the propellers may be controlled.

Regulation 38 – Engineers' alarm

An engineers' alarm shall be provided to be operated from the engine control room or at the manoeuvring platform as appropriate, and shall be clearly audible in the engineers' accommodation.

Regulation 39 – Location of emergency installations in passenger ships

Emergency sources of electrical power, fire pumps, bilge pumps except those specifically serving the spaces forward of the collision bulkhead, any fixed fire-extinguishing system required by chapter II-2 and other emergency installations which are essential for the safety of the ship, except anchor windlasses, shall not be installed forward of the collision bulkhead.

**Notice from the Danish Maritime Authority B –
The Construction and Equipment, etc. of Ships**

Chapter B II-1 D and E

Construction - Structure, subdivision and stability, machinery and electrical installations

Regulation 40 – General	1
Regulation 41 – Main source of electrical power and lighting systems	2
Regulation 42 – Emergency source of electrical power in passenger ships	3
Regulation 42-1 – Supplementary emergency lighting for ro-ro passenger ships.....	6
Regulation 43 – Emergency source of electrical power in cargo ships	7
Regulation 44 – Starting arrangements for emergency generating sets.....	10
Regulation 45 – Precautions against shock, fire and other hazards of electrical origin	11
Regulation 46 – General	14
Regulation 47 – Fire precautions	14
Regulation 48 – Protection against flooding.....	14
Regulation 49 – Control of propulsion machinery from the navigation bridge.....	14
Regulation 50 – Communication	15
Regulation 51 – Alarm system.....	15
Regulation 52 – Safety systems	16
Regulation 53 – Special requirements for machinery, boiler and electrical installations.....	16
Regulation 54 – Special consideration in respect of passenger ships.....	16
Regulation 55 – Alternative design and arrangements	17

Part D – Electrical installations

(Except where expressly provided otherwise part D applies to passenger ships and cargo ships)

Regulation 40 – General

1. Electrical installations shall be such that:
 - 1.1. all electrical auxiliary services necessary for maintaining the ship in normal operational and habitable conditions will be ensured without recourse to the emergency source of electrical power;
 - 1.2. electrical services essential for safety will be ensured under various emergency conditions; and
 - 1.3. the safety of passengers, crew and ship from electrical hazards will be ensured.
2. The Administration shall take appropriate steps to ensure uniformity in the implementation and application of the provisions of this part in respect of electrical installations.¹

¹ Refer to the recommendations published by the International Electrotechnical Commission and, in particular, Publication 92 - Electrical Installations in Ships.

Regulation 41 – Main source of electrical power and lighting systems

- 1.1. A main source of electrical power of sufficient capacity to supply all those services mentioned in regulation 40.1.1 shall be provided. This main source of electrical power shall consist of at least two generating sets.
- 1.2. The capacity of these generating sets shall be such that in the event of any one generating set being stopped it will still be possible to supply those services necessary to provide normal operational conditions of propulsion and safety. Minimum comfortable conditions of habitability shall also be ensured which include at least adequate services for cooking, heating, domestic refrigeration, mechanical ventilation, sanitary and fresh water.
- 1.3. The arrangements of the ship's main source of electrical power shall be such that the services referred to in regulation 40.1.1 can be maintained regardless of the speed and direction of rotation of the propulsion machinery or shafting.
- 1.4. In addition, the generating sets shall be such as to ensure that with any one generator or its primary source of power out of operation, the remaining generating sets shall be capable of providing the electrical services necessary to start the main propulsion plant from a dead ship condition. The emergency source of electrical power may be used for the purpose of starting from a dead ship condition if its capability either alone or combined with that of any other source of electrical power is sufficient to provide at the same time those services required to be supplied by regulations 42.2.1 to 42.2.3 or 43.2.1 to 43.2.4.
- 1.5. Where transformers constitute an essential part of the electrical supply system required by this paragraph, the system shall be so arranged as to ensure the same continuity of the supply as is stated in this paragraph.
2.
 - 2.1. A main electric lighting system which shall provide illumination throughout those parts of the ship normally accessible to and used by passengers or crew shall be supplied from the main source of electrical power.
 - 2.2. The arrangement of the main electric lighting system shall be such that a fire or other casualty in spaces containing the main source of electrical power, associated transforming equipment, if any, the main switchboard and the main lighting switchboard, will not render the emergency electric lighting system required by regulations 42.2.1 and 42.2.2 or 43.2.1, 43.2.2 and 43.2.3 inoperative.
 - 2.3. The arrangement of the emergency electric lighting system shall be such that a fire or other casualty in spaces containing the emergency source of electrical power, associated transforming equipment, if any, the emergency switchboard and the emergency lighting switchboard will not render the main electric lighting system required by this regulation inoperative.
3. The main switchboard shall be so placed relative to one main generating station that, as far as is practicable, the integrity of the normal electrical supply may be affected only by a fire or other casualty in one space. An environmental enclosure for the main switchboard, such as may be provided by a machinery control room situated within the main boundaries of the space, is not to be considered as separating the switchboards from the generators.
4. Where the total installed electrical power of the main generating sets is in excess of 3 MW, the main busbars shall be subdivided into at least two parts which shall normally be connected by removable links or other approved means; so far as is practicable, the connection of generating sets and any other duplicated equipment shall be equally divided between the parts. Equivalent arrangements may be permitted to the satisfaction of the Administration.
5. Ships constructed on or after 1 July 1998 *and cargo ships with a gross tonnage below 500 constructed on or after 1 January 2002:*

- 5.1. in addition to paragraphs 1 to 3, shall comply with the following:
 - 5.1.1. where the main source of electrical power is necessary for propulsion and steering of the ship, the system shall be so arranged that the electrical supply to equipment necessary for propulsion and steering and to ensure safety of the ship will be maintained or immediately restored in the case of loss of any one of the generators in service;
 - 5.1.2. load shedding or other equivalent arrangements shall be provided to protect the generators required by this regulation against sustained overload;
 - 5.1.3. where the main source of electrical power is necessary for propulsion of the ship, the main busbar shall be subdivided into at least two parts which shall normally be connected by circuit breakers or other approved means; so far as is practicable, the connection of generating sets and other duplicated equipment shall be equally divided between the parts; and
- 5.2. need not comply with paragraph 4.
6. In passenger ships, supplementary lighting shall be provided in all cabins to clearly indicate the exit so that occupants will be able to find their way to the door. Such lighting, which may be connected to an emergency source of power or have a self-contained source of electrical power in each cabin, shall automatically illuminate when power to the normal cabin lighting is lost and remain on for a minimum of 30 min.

Regulation 42 – Emergency source of electrical power in passenger ships

(Paragraphs 2.6.1 and 4.2 of this regulation apply to ships constructed on or after 1 February 1992)

- 1.1. A self-contained emergency source of electrical power shall be provided.
- 1.2. The emergency source of electrical power, associated transforming equipment, if any, transitional source of emergency power, emergency switchboard and emergency lighting switchboard shall be located above the uppermost continuous deck and shall be readily accessible from the open deck. They shall not be located forward of the collision bulkhead.
- 1.3. The location of the emergency source of electrical power and associated transforming equipment, if any, the transitional source of emergency power, the emergency switchboard and the emergency electric lighting switchboards in relation to the main source of electrical power, associated transforming equipment, if any, and the main switchboard shall be such as to ensure to the satisfaction of the Administration that a fire or other casualty in spaces containing the main source of electrical power, associated transforming equipment, if any, and the main switchboard or in any machinery space of category A will not interfere with the supply, control and distribution of emergency electrical power. As far as practicable, the space containing the emergency source of electrical power, associated transforming equipment, if any, the transitional source of emergency electrical power and the emergency switchboard shall not be contiguous to the boundaries of machinery spaces of category A or those spaces containing the main source of electrical power, associated transforming equipment, if any, or the main switchboard.
- 1.4. Provided that suitable measures are taken for safeguarding independent emergency operation under all circumstances, the emergency generator may be used exceptionally, and for short periods, to supply non-emergency circuits.
2. The electrical power available shall be sufficient to supply all those services that are essential for safety in an emergency, due regard being paid to such services as may have to be operated simultaneously. The emergency source of electrical power shall be capable, having regard to

starting currents and the transitory nature of certain loads, of supplying simultaneously (*simultaneity factor 1*) at least the following services for the periods specified hereinafter, if they depend upon an electrical source for their operation:

- 2.1. For a period of 36 h, emergency lighting:
 - 2.1.1. at every muster and embarkation station and over the sides as required by regulations III/11.4 and III/16.7;
 - 2.1.2. in alleyways, stairways and exits giving access to the muster and embarkation stations, as required by regulation III/11.5;
 - 2.1.3. in all service and accommodation alleyways, stairways and exits, personnel lift cars;
 - 2.1.4. in the machinery spaces and main generating stations including their control positions;
 - 2.1.5. in all control stations, machinery control rooms, and at each main and emergency switchboard;
 - 2.1.6. at all stowage positions for firemen's outfits;
 - 2.1.7. at the steering gear; and
 - 2.1.8. at the fire pump, the sprinkler pump and the emergency bilge pump referred to in paragraph 2.4 and at the starting position of their motors.
 - 2.2. For a period of 36 h:
 - 2.2.1. the navigation lights and other lights required by the International Regulations for Preventing Collisions at Sea in force; and
 - 2.2.2. on ships constructed on or after 1 February 1995, the VHF radio installation required by regulation IV/7.1.1 and IV/7.1.2; and, if applicable:
 - 2.2.2.1. the MF radio installation required by regulations IV/9.1.1, IV/9.1.2, IV/10.1.2 and IV/10.1.3;
 - 2.2.2.2. the ship earth station required by regulation IV/10.1.1; and
 - 2.2.2.3. the MF/HF radio installation required by regulations IV/10.2.1, IV/10.2.2 and IV/11.1.
 - 2.3. For a period of 36 h:
 - 2.3.1. all internal communication equipment required in an emergency;
 - 2.3.2. the shipborne navigational equipment as required by regulation V/12; where such provision is unreasonable or impracticable the Administration may waive this requirement for ships of less than 5,000 gross tonnage;
 - 2.3.3. the fire detection and fire alarm system, and the fire door holding and release system; and
 - 2.3.4. for intermittent operation of the daylight signalling lamp, the ship's whistle, the manually operated call points, and all internal signals that are required in an emergency;
- unless such services have an independent supply for the period of 36 h from an accumulator battery suitably located for use in an emergency.
- 2.4. For a period of 36 h:
 - 2.4.1. one of the fire pumps required by regulation II-2/4.3.1 and 4.3.3;
 - 2.4.2. the automatic sprinkler pump, if any; and
 - 2.4.3. the emergency bilge pump and all the equipment essential for the operation of electrically powered remote controlled bilge valves.
 - 2.5. For the period of time required by regulation 29.14 the steering gear if required to be so supplied by that regulation.

- 2.6. For a period of half an hour:
 - 2.6.1. any watertight doors required by regulation 15 to be power-operated together with their indicators and warning signals;
 - 2.6.2. the emergency arrangements to bring the lift cars to deck level for the escape of persons. The passenger lift cars may be brought to deck level sequentially in an emergency.
- 2.7. In a ship engaged regularly on voyages of short duration, the Administration if satisfied that an adequate standard of safety would be attained may accept a lesser period than the 36 h period specified in paragraphs 2.1 to 2.5 but not less than 12 h.
3. The emergency source of electrical power may be either a generator or an accumulator battery, which shall comply with the following:
 - 3.1. Where the emergency source of electrical power is a generator, it shall be:
 - 3.1.1. driven by a suitable prime mover with an independent supply of fuel having a flashpoint (closed cup test) of not less than 43°C;
 - 3.1.2. started automatically upon failure of the electrical supply from the main source of electrical power and shall be automatically connected to the emergency switchboard; those services referred to in paragraph 4 shall then be transferred automatically to the emergency generating set. The automatic starting system and the characteristic of the prime mover shall be such as to permit the emergency generator to carry its full rated load as quickly as is safe and practicable, subject to a maximum of 45 s; unless a second independent means of starting the emergency generating set is provided, the single source of stored energy shall be protected to preclude its complete depletion by the automatic starting system; and
 - 3.1.3. provided with a transitional source of emergency electrical power according to paragraph 4.
 - 3.2. Where the emergency source of electrical power is an accumulator battery, it shall be capable of:
 - 3.2.1. carrying the emergency electrical load without recharging while maintaining the voltage of the battery throughout the discharge period within 12% above or below its nominal voltage;
 - 3.2.2. automatically connecting to the emergency switchboard in the event of failure of the main source of electrical power; and
 - 3.2.3. immediately supplying at least those services specified in paragraph 4.
 - 3.3. The following provisions in paragraph 3.1.2 shall not apply to ships constructed on or after 1 October 1994:

Unless a second independent means of starting the emergency generating set is provided, the single source of stored energy shall be protected to preclude its complete depletion by the automatic starting system.
 - 3.4. For ships constructed on or after 1 July 1998, where electrical power is necessary to restore propulsion, the capacity shall be sufficient to restore propulsion to the ship in conjunction with other machinery, as appropriate, from a dead ship condition within 30 min after blackout.
4. The transitional source of emergency electrical power required by paragraph 3.1.3 shall consist of an accumulator battery suitably located for use in an emergency which shall operate without recharging while maintaining the voltage of the battery throughout the discharge period within 12% above or below its nominal voltage and be of sufficient capacity and so arranged as to supply automatically in the event of failure of either the main or emergency source of electrical

power at least the following services, if they depend upon an electrical source for their operation:

- 4.1. For half an hour:
 - 4.1.1. the lighting required by paragraphs 2.1 and 2.2;
 - 4.1.2. all services required by paragraphs 2.3.1, 2.3.3 and 2.3.4 unless such services have an independent supply for the period specified from an accumulator battery suitably located for use in an emergency.
- 4.2. Power to operate the watertight doors, as required by regulation 15.7.3.3, but not necessarily all of them simultaneously, unless an independent temporary source of stored energy is provided. Power to the control, indication and alarm circuits as required by regulation 15.7.2 for half an hour.
5.
 - 5.1. The emergency switchboard shall be installed as near as is practicable to the emergency source of electrical power.
 - 5.2. Where the emergency source of electrical power is a generator, the emergency switchboard shall be located in the same space unless the operation of the emergency switchboard would thereby be impaired.
 - 5.3. No accumulator battery fitted in accordance with this regulation shall be installed in the same space as the emergency switchboard. An indicator shall be mounted in a suitable place on the main switchboard or in the machinery control room to indicate when the batteries constituting either the emergency source of electrical power or the transitional source of emergency electrical power referred to in paragraph 3.1.3 or 4 are being discharged.
 - 5.4. The emergency switchboard shall be supplied during normal operation from the main switchboard by an interconnector feeder which is to be adequately protected at the main switchboard against overload and short circuit and which is to be disconnected automatically at the emergency switchboard upon failure of the main source of electrical power. Where the system is arranged for feedback operation, the interconnector feeder is also to be protected at the emergency switchboard at least against short circuit.
 - 5.5. In order to ensure ready availability of the emergency source of electrical power, arrangements shall be made where necessary to disconnect automatically non-emergency circuits from the emergency switchboard to ensure that power shall be available to the emergency circuits.
6. The emergency generator and its prime mover and any emergency accumulator battery shall be so designed and arranged as to ensure that they will function at full rated power when the ship is upright and when inclined at any angle of list up to 22.5° or when inclined up to 10° either in the fore or aft direction, or is in any combination of angles within those limits.
7. Provision shall be made for the periodic testing of the complete emergency system and shall include the testing of automatic starting arrangements.

Regulation 42-1 – Supplementary emergency lighting for ro-ro passenger ships

This regulation applies to all passenger ships with ro-ro cargo spaces or special category spaces as defined in regulation II-2/3, except that for ships constructed before 22 October 1989, this regulation shall apply not later than 22 October 1990.

1. In addition to the emergency lighting required by regulation 42.2, on every passenger ship with ro-ro cargo spaces or special category spaces as defined in regulation II-2/3:
 - 1.1. all passenger public spaces and alleyways shall be provided with supplementary electric lighting that can operate for at least 3 h when all other sources of electrical power have

failed and under any condition of heel. The illumination provided shall be such that the approach to the means of escape can be readily seen. The source of power for the supplementary lighting shall consist of accumulator batteries located within the lighting units that are continuously charged, where practicable, from the emergency switchboard. Alternatively, any other means of lighting which is at least as effective may be accepted by the Danish Maritime Authority. The supplementary lighting shall be such that any failure of the lamp will be immediately apparent. Any accumulator battery provided shall be replaced at intervals having regard to the specified service life in the ambient conditions that they are subject to in service; and

- 1.2. a portable rechargeable battery operated lamp shall be provided in every crew space alleyway, recreational space and every working space which is normally occupied unless supplementary emergency lighting, as required by subparagraph .1, is provided.

Regulation 43 – Emergency source of electrical power in cargo ships

- 1.1. self-contained emergency source of electrical power shall be provided.
 - 1.2. The emergency source of electrical power, associated transforming equipment, if any, transitional source of emergency power, emergency switchboard and emergency lighting switchboard shall be located above the uppermost continuous deck and shall be readily accessible from the open deck. They shall not be located forward of the collision bulkhead, except where permitted by the Administration in exceptional circumstances.
 - 1.3. The location of the emergency source of electrical power, associated transforming equipment, if any, the transitional source of emergency power, the emergency switchboard and the emergency lighting switchboard in relation to the main source of electrical power, associated transforming equipment, if any, and the main switchboard shall be such as to ensure to the satisfaction of the Administration that a fire or other casualty in the space containing the main source of electrical power, associated transforming equipment, if any, and the main switchboard, or in any machinery space of category A will not interfere with the supply, control and distribution of emergency electrical power. As far as practicable the space containing the emergency source of electrical power, associated transforming equipment, if any, the transitional source of emergency electrical power and the emergency switchboard shall not be contiguous to the boundaries of machinery spaces of category A or those spaces containing the main source of electrical power, associated transforming equipment, if any, and the main switchboard.
 - 1.4. Provided that suitable measures are taken for safeguarding independent emergency operation under all circumstances, the emergency generator may be used, exceptionally, and for short periods, to supply non-emergency circuits.
2. The electrical power available shall be sufficient to supply all those services that are essential for safety in an emergency, due regard being paid to such services as may have to be operated simultaneously. The emergency source of electrical power shall be capable, having regard to starting currents and the transitory nature of certain loads, of supplying simultaneously at least the following services for the periods specified hereinafter, if they depend upon an electrical source for their operation:
 - 2.1. For a period of 3 h, emergency lighting at every muster and embarkation station and over the sides as required by regulations III/11.4 and III/16.7.
 - 2.2. For a period of 18 h, emergency lighting:
 - 2.2.1. in all service and accommodation alleyways, stairways and exits, personnel lift cars and personnel lift trunks;

- 2.2.2. in the machinery spaces and main generating stations including their control positions;
- 2.2.3. in all control stations, machinery control rooms, and at each main and emergency switchboard;
- 2.2.4. at all stowage positions for firemen's outfits;
- 2.2.5. at the steering gear;
- 2.2.6. at the fire pump referred to in paragraph 2.5, at the sprinkler pump, if any, and at the emergency bilge pump, if any, and at the starting positions of their motors; and
- 2.2.7. in all cargo pump-rooms of tankers constructed on or after 1 July 2002.
- 2.3. For a period of 18 h:
 - 2.3.1. the navigation lights and other lights required by the International Regulations for Preventing Collisions at Sea in force;
 - 2.3.2. on ships constructed on or after 1 February 1995 the VHF radio installation required by regulation IV/7.1.1 and IV/7.1.2; and, if applicable:
 - 2.3.2.1. the MF radio installation required by regulations IV/9.1.1, IV/9.1.2, IV/10.1.2 and IV/10.1.3;
 - 2.3.2.2. the ship earth station required by regulation IV/10.1.1; and
 - 2.3.2.3. the MF/HF radio installation required by regulations IV/10.2.1, IV/10.2.2 and IV/11.1.
- 2.4. For a period of 18 h:
 - 2.4.1. all internal communication equipment as required in an emergency;
 - 2.4.2. the shipborne navigational equipment as required by regulation V/19; where such provision is unreasonable or impracticable the Administration may waive this requirement for ships of less than 5,000 gross tonnage;
 - 2.4.3. the fire detection and fire alarm system; and
 - 2.4.4. intermittent operation of the daylight signalling lamp, the ship's whistle, the manually operated call points and all internal signals that are required in an emergency; unless such services have an independent supply for the period of 18 h from an accumulator battery suitably located for use in an emergency.
- 2.5. For a period of 18 h one of the fire pumps required by regulation II-2/4.3.1 and 4.3.3 if dependent upon the emergency generator for its source of power.
- 2.6.
 - 2.6.1. For the period of time required by regulation 29.14 the steering gear where it is required to be so supplied by that regulation.
 - 2.6.2. In a ship engaged regularly in voyages of short duration, the Administration if satisfied that an adequate standard of safety would be attained may accept a lesser period than the 18 h period specified in paragraphs 2.2 to 2.5 but not less than 12 h. *In cargo ships with a gross tonnage below 500, the Administration may accept a period of 8 hours instead of 18 hours as stipulated in paragraphs 2.2-2.5.*
- 3. The emergency source of electrical power may be either a generator or an accumulator battery, which shall comply with the following:
 - 3.1. Where the emergency source of electrical power is a generator, it shall be:
 - 3.1.1. driven by a suitable prime mover with an independent supply of fuel, having a flashpoint (closed cup test) of not less than 43°C;
 - 3.1.2. started automatically upon failure of the main source of electrical power supply unless a transitional source of emergency electrical power in accordance with paragraph 3.1.3 is provided; where the emergency generator is automatically started, it shall be automatically connected to the emergency switchboard; those

- services referred to in paragraph 4 shall then be connected automatically to the emergency generator; and unless a second independent means of starting the emergency generator is provided the single source of stored energy shall be protected to preclude its complete depletion by the automatic starting system; and
- 3.1.3. provided with a transitional source of emergency electrical power as specified in paragraph 4 unless an emergency generator is provided capable both of supplying the services mentioned in that paragraph and of being automatically started and supplying the required load as quickly as is safe and practicable subject to a maximum of 45 s.
- 3.2. Where the emergency source of electrical power is an accumulator battery it shall be capable of:
 - 3.2.1. carrying the emergency electrical load without recharging while maintaining the voltage of the battery throughout the discharge period within 12% above or below its nominal voltage;
 - 3.2.2. automatically connecting to the emergency switchboard in the event of failure of the main source of electrical power; and
 - 3.2.3. immediately supplying at least those services specified in paragraph 4.
 - 3.3. The following provision in paragraph 3.1.2 shall not apply to ships constructed on or after 1 October 1994:

Unless a second independent means of starting the emergency generating set is provided, the single source of stored energy shall be protected to preclude its complete depletion by the automatic starting system.

- 3.4. For ships constructed on or after 1 July 1998 *and cargo ships with a gross tonnage below 500 constructed on or after 1 January 2002* where electrical power is necessary to restore propulsion, the capacity shall be sufficient to restore propulsion to the ship in conjunction with other machinery, as appropriate, from a dead ship condition within 30 min after blackout.
4. The transitional source of emergency electrical power where required by paragraph 3.1.3 shall consist of an accumulator battery suitably located for use in an emergency which shall operate without recharging while maintaining the voltage of the battery throughout the discharge period within 12% above or below its nominal voltage and be of sufficient capacity and shall be so arranged as to supply automatically in the event of failure of either the main or the emergency source of electrical power for half an hour at least the following services if they depend upon an electrical source for their operation:
 - 4.1. the lighting required by paragraphs 2.1, 2.2 and 2.3.1. For this transitional phase, the required emergency electric lighting, in respect of the machinery space and accommodation and service spaces may be provided by permanently fixed, individual, automatically charged, relay operated accumulator lamps; and
 - 4.2. all services required by paragraphs 2.4.1, 2.4.3 and 2.4.4 unless such services have an independent supply for the period specified from an accumulator battery suitably located for use in an emergency.
5.
 - 5.1. The emergency switchboard shall be installed as near as is practicable to the emergency source of electrical power.
 - 5.2. Where the emergency source of electrical power is a generator, the emergency switchboard shall be located in the same space unless the operation of the emergency switchboard would thereby be impaired.

- 5.3. No accumulator battery fitted in accordance with this regulation shall be installed in the same space as the emergency switchboard. An indicator shall be mounted in a suitable place on the main switchboard or in the machinery control room to indicate when the batteries constituting either the emergency source of electrical power or the transitional source of electrical power referred to in paragraph 3.2 or 4 are being discharged.
- 5.4. The emergency switchboard shall be supplied during normal operation from the main switchboard by an interconnector feeder which is to be adequately protected at the main switchboard against overload and short circuit and which is to be disconnected automatically at the emergency switchboard upon failure of the main source of electrical power. Where the system is arranged for feedback operation, the interconnector feeder is also to be protected at the emergency switchboard at least against short circuit.
- 5.5. In order to ensure ready availability of the emergency source of electrical power, arrangements shall be made where necessary to disconnect automatically non-emergency circuits from the emergency switchboard to ensure that electrical power shall be available automatically to the emergency circuits.
6. The emergency generator and its prime mover and any emergency accumulator battery shall be so designed and arranged as to ensure that they will function at full rated power when the ship is upright and when inclined at any angle of list up to 22.5° or when inclined up to 10° either in the fore or aft direction, or is in any combination of angles within those limits.
7. Provision shall be made for the periodic testing of the complete emergency system and shall include the testing of automatic starting arrangements.

Regulation 44 – Starting arrangements for emergency generating sets

1. Emergency generating sets shall be capable of being readily started in their cold condition at a temperature of 0°C. If this is impracticable, or if lower temperatures are likely to be encountered, provision acceptable to the Administration shall be made for the maintenance of heating arrangements, to ensure ready starting of the generating sets.
2. Each emergency generating set arranged to be automatically started shall be equipped with starting devices approved by the Administration with a stored energy capability of at least three consecutive starts. A second source of energy shall be provided for an additional three starts within 30 min unless manual starting can be demonstrated to be effective.
 - 2.1. Ships constructed on or after 1 October 1994 *and cargo ships with a gross tonnage below 500 constructed on or after 1 January 2002* in lieu of the provision of the second sentence of paragraph 2, shall comply with the following requirements:

The source of stored energy shall be protected to preclude critical depletion by the automatic starting system, unless a second independent means of starting is provided. In addition, a second source of energy shall be provided for an additional three starts within 30 min unless manual starting can be demonstrated to be effective.

3. The stored energy shall be maintained at all times, as follows:
 - 3.1. electrical and hydraulic starting systems shall be maintained from the emergency switchboard;
 - 3.2. compressed air starting systems may be maintained by the main or auxiliary compressed air receivers through a suitable non-return valve or by an emergency air compressor which, if electrically driven, is supplied from the emergency switchboard;
 - 3.3. all of these starting, charging and energy storing devices shall be located in the emergency generator space; these devices are not to be used for any purpose other than the operation of the emergency generating set. This does not preclude the supply to the air receiver of

the emergency generating set from the main or auxiliary compressed air system through the non-return valve fitted in the emergency generator space.

- 4.
- 4.1. Where automatic starting is not required, manual starting is permissible, such as manual cranking, inertia starters, manually charged hydraulic accumulators, or powder charge cartridges, where they can be demonstrated as being effective.
- 4.2. When manual starting is not practicable, the requirements of paragraphs 2 and 3 shall be complied with except that starting may be manually initiated.

Regulation 45 – Precautions against shock, fire and other hazards of electrical origin

(Paragraphs 10 and 11 in this regulation apply to ships constructed on or after 1 January 2007)

1.
 - 1.1. Exposed metal parts of electrical machines or equipment which are not intended to be live but which are liable under fault conditions to become live shall be earthed unless the machines or equipment are:
 - 1.1.1. supplied at a voltage not exceeding 50 V direct current or 50 V root mean square between conductors; autotransformers shall not be used for the purpose of achieving this voltage; or
 - 1.1.2. supplied at a voltage not exceeding 250 V by safety isolating transformers supplying only one consuming device; or
 - 1.1.3. constructed in accordance with the principle of double insulation.
 - 1.2. The Administration may require additional precautions for portable electrical equipment for use in confined or exceptionally damp spaces where particular risks due to conductivity may exist.
 - 1.3. All electrical apparatus shall be so constructed and so installed as not to cause injury when handled or touched in the normal manner.
2. Main and emergency switchboards shall be so arranged as to give easy access as may be needed to apparatus and equipment, without danger to personnel. The sides and the rear and, where necessary, the front of switchboards shall be suitably guarded. Exposed live parts having voltages to earth exceeding a voltage to be specified by the Administration shall not be installed on the front of such switchboards. Where necessary, nonconducting mats or gratings shall be provided at the front and rear of the switchboard.
3.
 - 3.1. The hull return system of distribution shall not be used for any purpose in a tanker, or for power, heating, or lighting in any other ship of 1,600 gross tonnage and upwards.
 - 3.2. The requirement of paragraph 3.1 does not preclude under conditions approved by the Administration the use of:
 - 3.2.1. impressed current cathodic protective systems;
 - 3.2.2. limited and locally earthed systems; or
 - 3.2.3. insulation level monitoring devices provided the circulation current does not exceed 30 mA under the most unfavourable conditions.

3.2-1 For ships constructed on or after 1 October 1994 *and cargo ships with a gross tonnage below 500 constructed on or after 1 January 2002* the requirement of paragraph 3.1 does not preclude the use of limited and locally earthed systems, provided that any possible resulting current does not flow directly through any dangerous spaces.
 - 3.3. Where the hull return system is used, all final subcircuits, i.e. all circuits fitted after the last protective device, shall be two-wire and special precautions shall be taken to the satisfaction of the Administration.

4.
 - 4.1. Earthed distribution systems shall not be used in a tanker. The Administration may exceptionally permit in a tanker the earthing of the neutral for alternating current power networks of 3,000 V (line to line) and over, provided that any possible resulting current does not flow directly through any of the dangerous spaces.
 - 4.2. When a distribution system, whether primary or secondary, for power, heating or lighting, with no connection to earth is used, a device capable of continuously monitoring the insulation level to earth and of giving an audible or visual indication of abnormally low insulation values shall be provided.
 - 4.3. Ships constructed on or after 1 October 1994 *and cargo ships with a gross tonnage below 500 constructed on or after 1 January 2002* in lieu of the provisions of paragraph 4.1, shall comply with the following requirements:
 - 4.3.1. Except as permitted by paragraph 4.3.2, earthed distribution systems shall not be used in a tanker.
 - 4.3.2. The requirement of paragraph 4.3.1 does not preclude the use of earthed intrinsically safe circuits and in addition, under conditions approved by the Administration, the use of the following earthed systems:
 - 4.3.2.1. power-supplied control circuits and instrumentation circuits where technical or safety reasons preclude the use of a system with no connection to earth, provided the current in the hull is limited to not more than 5 A in both normal and fault conditions; or
 - 4.3.2.2. limited and locally earthed systems, provided that any possible resulting current does not flow directly through any of the dangerous spaces; or
 - 4.3.2.3. alternating current power networks of 1,000 V root mean square (line to line) and over, provided that any possible resulting current does not flow directly through any of the dangerous spaces.
5.
 - 5.1. Except as permitted by the Administration in exceptional circumstances, all metal sheaths and armour of cables shall be electrically continuous and shall be earthed.
 - 5.2. ²All electric cables and wiring external to equipment shall be at least of a flame-retardant type and shall be so installed as not to impair their original flame-retarding properties. Where necessary for particular applications the Administration may permit the use of special types of cables such as radio frequency cables, which do not comply with the foregoing.
 - 5.3. Cables and wiring serving essential or emergency power, lighting, internal communications or signals shall so far as practicable be routed clear of galleys, laundries, machinery spaces of category A and their casings and other high fire risk areas. In ro-ro passenger ships, cabling for emergency alarms and public address systems installed on or after 1 July 1998 shall be approved by the Administration having regard to the recommendations developed by the Organization.³ Cables connecting fire pumps to the emergency switchboard shall be of a fire-resistant type where they pass through high fire risk areas. Where practicable all such cables should be run in such a manner as to preclude their being rendered unserviceable by heating of the bulkheads that may be caused by a fire in an adjacent space.

² Must be according to IEC Standard no. 331 or 332.

³ Refer to MSC/Circ.808, Recommendation on performance standards for public address systems on passenger ships, including cabling.

- 5.4. Where cables which are installed in hazardous areas introduce the risk of fire or explosion in the event of an electrical fault in such areas, special precautions against such risks shall be taken to the satisfaction of the Administration.
- 5.5. Cables and wiring shall be installed and supported in such a manner as to avoid chafing or other damage.
- 5.6. Terminations and joints in all conductors shall be so made as to retain the original electrical, mechanical, flame-retarding and, where necessary, fire-resisting properties of the cable.
6.
 - 6.1. Each separate circuit shall be protected against short circuit and against overload, except as permitted in regulations 29 and 30 or where the Administration may exceptionally otherwise permit.
 - 6.2. The rating or appropriate setting of the overload protective device for each circuit shall be permanently indicated at the location of the protective device.
7. Lighting fittings shall be so arranged as to prevent temperature rises which could damage the cables and wiring, and to prevent surrounding material from becoming excessively hot.
8. All lighting and power circuits terminating in a bunker or cargo space shall be provided with a multiple pole switch outside the space for disconnecting such circuits.
9.
 - 9.1. Accumulator batteries shall be suitably housed, and compartments used primarily for their accommodation shall be properly constructed and efficiently ventilated.
 - 9.2. Electrical or other equipment which may constitute a source of ignition of flammable vapours shall not be permitted in these compartments except as permitted in paragraph 10.
 - 9.3. Accumulator batteries shall not be located in sleeping quarters except where hermetically sealed to the satisfaction of the Administration.
10. No electrical equipment shall be installed in any space where flammable mixtures are liable to collect, e.g. in compartments assigned principally to accumulator batteries, in paint lockers, acetylene stores or similar spaces, unless the administration is satisfied that such equipment is:
 - 10.1. essential for operational purposes;
 - 10.2. of a type which will not ignite the mixture concerned;
 - 10.3. appropriate to the space concerned; and
 - 10.4. appropriately certified for safe usage in the dusts, vapours or gases likely to be encountered.
11. In tankers, electrical equipment, cables and wiring shall not be installed in hazardous locations unless it conforms with standards not inferior to those acceptable to the Organization.⁴ However, for locations not covered by such standards, electrical equipment, cables and wiring which do not conform to the standards may be installed in hazardous locations based on risk assessment to the satisfaction of the Administration, to ensure that an equivalent level of safety is assured.
12. In a passenger ship, distribution systems shall be so arranged that fire in any main vertical zone as is defined in regulation II-2/3.9 will not interfere with services essential for safety in any other such zone. This requirement will be met if main and emergency feeders passing through any such zone are separated both vertically and horizontally as widely as is practicable.

Part E – Additional requirements for periodically unattended machinery spaces

(Part E applies to cargo ships except that regulation 54 refers to passenger ships)

⁴ Refer to the standards published by the international Electrotechnical Commission, IEC 600092502:1999 “Electrical installations in ships – Tankers”.

Regulation 46 – General

1. The arrangements provided shall be such as to ensure that the safety of the ship in all sailing conditions, including manoeuvring, is equivalent to that of a ship having the machinery spaces manned.
2. Measures shall be taken to the satisfaction of the Administration to ensure that the equipment is functioning in a reliable manner and that satisfactory arrangements are made for regular inspections and routine tests to ensure continuous reliable operation.
3. Every ship shall be provided with documentary evidence,⁵ to the satisfaction of the Administration, of its fitness to operate with periodically unattended machinery spaces.

Regulation 47 – Fire precautions

1. Means shall be provided to detect and give alarms at an early stage in case of fires:
 - 1.1. in boiler air supply casings and exhausts (uptakes); and
 - 1.2. in scavenging air belts of propulsion machinery, unless the Administration considers this to be unnecessary in a particular case.
2. Internal combustion engines of 2,250 kW and above or having cylinders of more than 300 mm bore shall be provided with crankcase oil mist detectors or engine bearing temperature monitors or equivalent devices.

Regulation 48 – Protection against flooding

1. Bilge wells in periodically unattended machinery spaces shall be located and monitored in such a way that the accumulation of liquids is detected at normal angles of trim and heel, and shall be large enough to accommodate easily the normal drainage during the unattended period.
2. Where the bilge pumps are capable of being started automatically, means shall be provided to indicate when the influx of liquid is greater than the pump capacity or when the pump is operating more frequently than would normally be expected. In these cases, smaller bilge wells to cover a reasonable period of time may be permitted. Where automatically controlled bilge pumps are provided, special attention shall be given to oil pollution prevention requirements.
3. The location of the controls of any valve serving a sea inlet, a discharge below the waterline or a bilge injection system shall be so sited as to allow adequate time for operation in case of influx of water to the space, having regard to the time likely to be required in order to reach and operate such controls. If the level to which the space could become flooded with the ship in the fully loaded condition so requires, arrangements shall be made to operate the controls from a position above such level.

Regulation 49 – Control of propulsion machinery from the navigation bridge

1. Under all sailing conditions, including manoeuvring, the speed, direction of thrust and, if applicable, the pitch of the propeller shall be fully controllable from the navigation bridge.
 - 1.1. Such remote control shall be performed by a single control device for each independent propeller, with automatic performance of all associated services, including, where necessary, means of preventing overload of the propulsion machinery.
 - 1.2. The main propulsion machinery shall be provided with an emergency stopping device on the navigation bridge which shall be independent of the navigation bridge control system.
2. Propulsion machinery orders from the navigation bridge shall be indicated in the main machinery control room or at the propulsion machinery control position as appropriate.

⁵ For cargo ships registered in a recognized classification society this documentary evidence must be issued by the classification society or by the Danish Maritime Authority.

3. Remote control of the propulsion machinery shall be possible only from one location at a time; at such locations interconnected control positions are permitted. At each location there shall be an indicator showing which location is in control of the propulsion machinery. The transfer of control between the navigation bridge and machinery spaces shall be possible only in the main machinery space or in the main machinery control room. The system shall include means to prevent the propelling thrust from altering significantly when transferring control from one location to another.
4. It shall be possible for all machinery essential for the safe operation of the ship to be controlled from a local position, even in the case of failure in any part of the automatic or remote control systems.
5. The design of the remote automatic control system shall be such that in case of its failure an alarm will be given. Unless the Administration considers it impracticable, the preset speed and direction of thrust of the propeller shall be maintained until local control is in operation.
6. Indicators shall be fitted on the navigation bridge for:
 - 6.1. propeller speed and direction of rotation in the case of fixed pitch propellers; or
 - 6.2. propeller speed and pitch position in the case of controllable pitch propellers.
7. The number of consecutive automatic attempts which fail to produce a start shall be limited to safeguard sufficient starting air pressure. An alarm shall be provided to indicate low starting air pressure set at a level which still permits starting operations of the propulsion machinery.

Regulation 50 – Communication

A reliable means of vocal communication shall be provided between the main machinery control room or the propulsion machinery control position as appropriate, the navigation bridge and the engineer officers' accommodation.

Regulation 51 – Alarm system

1. An alarm system shall be provided indicating any fault requiring attention and shall:
 - 1.1. be capable of sounding an audible alarm in the main machinery control room or at the propulsion machinery control position, and indicate visually each separate alarm function at a suitable position;
 - 1.2. have a connection to the engineers' public rooms and to each of the engineers' cabins through a selector switch, to ensure connection to at least one of those cabins. Administrations may permit equivalent arrangements;
 - 1.3. activate an audible and visual alarm on the navigation bridge for any situation which requires action by or attention of the officer on watch;
 - 1.4. as far as is practicable be designed on the fail-to-safety principle; and
 - 1.5. activate the engineers' alarm required by regulation 38 if an alarm function has not received attention locally within a limited time.
2.
 - 2.1. The alarm system shall be continuously powered and shall have an automatic change-over to a stand-by power supply in case of loss of normal power supply.
 - 2.2. Failure of the normal power supply of the alarm system shall be indicated by an alarm.
3.
 - 3.1. The alarm system shall be able to indicate at the same time more than one fault and the acceptance of any alarm shall not inhibit another alarm.
 - 3.2. Acceptance at the position referred to in paragraph 1 of any alarm condition shall be indicated at the positions where it was shown. Alarms shall be maintained until they are accepted and the visual indications of individual alarms shall remain until the fault has

been corrected, when the alarm system shall automatically reset to the normal operating condition.

Regulation 52 – Safety systems

A safety system shall be provided to ensure that serious malfunction in machinery or boiler operations, which presents an immediate danger, shall initiate the automatic shutdown of that part of the plant and that an alarm shall be given.

Shutdown of the propulsion system shall not be automatically activated except in cases which could lead to serious damage, complete breakdown, or explosion. Where arrangements for overriding the shutdown of the main propelling machinery are fitted, these shall be such as to preclude inadvertent operation. Visual means shall be provided to indicate when the override has been activated.

Regulation 53 – Special requirements for machinery, boiler and electrical installations

1. The special requirements for the machinery, boiler and electrical installations shall be to the satisfaction of the Administration and shall include at least the requirements of this regulation.
2. The main source of electrical power shall comply with the following:
 - 2.1. Where the electrical power can normally be supplied by one generator, suitable load-shedding arrangements shall be provided to ensure the integrity of supplies to services required for propulsion and steering as well as the safety of the ship. In the case of loss of the generator in operation, adequate provision shall be made for automatic starting and connecting to the main switchboard of a stand-by generator of sufficient capacity to permit propulsion and steering and to ensure the safety of the ship with automatic restarting of the essential auxiliaries including, where necessary, sequential operations. The Administration may dispense with this requirement for a ship of less than 1,600 gross tonnage, if it is considered impracticable.
 - 2.2. If the electrical power is normally supplied by more than one generator simultaneously in parallel operation, provision shall be made, for instance by load shedding, to ensure that, in case of loss of one of these generating sets, the remaining ones are kept in operation without overload to permit propulsion and steering, and to ensure the safety of the ship.
3. Where stand-by machines are required for other auxiliary machinery essential to propulsion, automatic change-over devices shall be provided.
4. Automatic control and alarm system
 - 4.1. The control system shall be such that the services needed for the operation of the main propulsion machinery and its auxiliaries are ensured through the necessary automatic arrangements.
 - 4.2. An alarm shall be given on the automatic changeover.
 - 4.3. An alarm system complying with regulation 51 shall be provided for all important pressures, temperatures and fluid levels and other essential parameters.
 - 4.4. A centralized control position shall be arranged with the necessary alarm panels and instrumentation indicating any alarm.
5. Means shall be provided to keep the starting air pressure at the required level where internal combustion engines are used for main propulsion.

Regulation 54 – Special consideration in respect of passenger ships

Passenger ships shall be specially considered by the Administration as to whether or not their machinery spaces may be periodically unattended and if so whether additional requirements to

those stipulated in these regulations are necessary to achieve equivalent safety to that of normally attended machinery spaces.

Part F – Alternative design and arrangements

Regulation 55 – Alternative design and arrangements

1. Purpose

The purpose of this regulation is to provide a methodology for alternative design and arrangements for machinery and electrical installations.

2. General

- 2.1. Machinery and electrical installation design and arrangements may deviate from the requirements set out in parts C, D and E, provided that the alternative design and arrangements meet the intent of the requirements concerned and provide an equivalent level of safety to this chapter.
- 2.2. When alternative design or arrangements deviate from the prescriptive requirements of parts, C, D and E, an engineering analysis, evaluation and approval of the design and equipment and arrangements shall be carried out in accordance with this regulation.

3. Engineering analysis

The engineering analysis shall be prepared and submitted to the Administration, based on the guidelines developed by the Organization⁶ and shall include, as a minimum, the following elements:

- 3.1. determination of the ship type, machinery, electrical installations and space(s) concerned;
- 3.2. identification of the prescriptive requirement(s) with which the machinery and electrical installations will not comply;
- 3.3. identification of the reason the proposed design will not meet the prescriptive requirements supported by compliance with other recognized engineering or industry standards;
- 3.4. determination of the performance criteria for the ship, machinery, electrical installation or the space(s) concerned addressed by the relevant prescriptive requirement(s):
 - 3.4.1. performance criteria shall provide a level of safety not inferior to the relevant prescriptive requirements contained in parts C, D and E; and
 - 3.4.2. performance criteria shall be quantifiable and measurable;
- 3.5. detailed description of the alternative design and arrangements, including a list of the assumptions used in the design and any proposed operational restrictions or conditions;
- 3.6. technical justification demonstrating that the alternative design and arrangements meet the safety performance criteria; and
- 3.7. risk assessment based on identification of the potential faults and hazards associated with the proposal.

4. Evaluation of the alternative design and arrangements

- 4.1. The engineering analysis required in paragraph 3 shall be evaluated and approved by the Administration, taking into account the guidelines developed by the Organization.⁷
- 4.2. A copy of the documentation, as approved by the Administration, indicating that the alternative design and arrangements comply with this regulation, shall be carried on board the ship.

5. Exchange of information

⁶ Refer to the Guidelines on alternative design and arrangements for SOLAS chapters II-1 and III (MSC.1/Circ.1212).

⁷ Refer to the Guidelines on alternative design and arrangements for SOLAS chapters II-1 and III (MSC.1/Circ.1212).

The Administration shall communicate to the Organization pertinent information concerning alternative design and arrangements approved by them for circulation to all Contracting Governments.

6. Re-evaluation due to change of conditions

If the assumptions and operational restrictions that were stipulated in the alternative design and arrangements are changed, the engineering analysis shall be carried out under the changed condition and shall be approved by the Administration.

**Notice from the Danish Maritime Authority B –
The Construction and Equipment, etc. of Ships**

Chapter B II-1 N(1)

Construction – Structure, subdivision and stability, machinery and electrical installations

Additional Danish regulations to

Regulation 34-1

Refrigerating plant

1. Cargo and provision refrigerating plant

- 1.1. Refrigerating plant shall mean any refrigerating plant – except for domestic refrigerators and freezers – containing refrigerating agents in the form of fluids or liquefied gases with a vapour pressure in excess of 0.1 N/mm² at + 30 °C.***
- 1.2. Doors to all refrigerated, freezer and blast-freeze rooms in which persons may move about shall open outwards, and the closing and locking mechanisms of such doors shall, irrespective of the temperature and temperature differences, function easily and reliably when operated from the inside, even when locked.***
- 1.3. All refrigerated and freezer rooms in which persons may move about shall be provided with permanently installed electric light.***
- 1.4. In the case of plants containing refrigerating agents in the form of fluoridated hydrocarbons, a warning sign shall be placed in a conspicuous position reading "Smoking could result in danger of poisoning". Danish text: "Tobaksrygning medfører forgiftningsfare".***
- 1.5. As a guidance for the machinery personnel, a complete plan of the refrigerating plant with an associated description and rules of operation shall be kept on board.***

2. Provision cold store

- 2.1. The light switch shall be placed inside the room, and when the light is lit, a red pilot lamp, placed immediately outside the cold store or in another place approved by the Danish Maritime Authority, shall light at the same time.***
- 2.2. In addition to the above pilot lamp, an electric alarm system with an acoustic signalling device shall be installed in a suitable place, e.g. in the galley, and the operating switches for the plant shall be installed immediately inside the doors to each cold store. It must only be possible to switch off the signalling device by means of the switch from which it has been started, and it shall be connected to a group other than the light installation in the store or stores. In the case of new ships, this group shall, however, be an emergency light group.***
- 2.3. The various pressure components of the refrigerating plant shall be identifiable, and pressure vessels shall be marked in accordance with recognised test standards.***
- 2.4. Pressure-testing of the components forming part of the plant and of the entire plant shall be carried out on the basis of a recognised test standard. Testing of cargo***

1 April 2008

refrigerating plants shall be carried out by a recognised classification society or by recognised test institutes, including test institutes in other EU member states and in countries covered by the EEA agreement and in Turkey, and which provide suitable and satisfactory guarantees of a technical, professional and independent character. As regards air-conditioned and provision refrigerating plants, workshop certificates shall be accepted.

Notice from the Danish Maritime Authority B – The Construction and Equipment, etc. of Ships

Chapter B II-2

Construction – Fire protection, fire detection and fire extinction

Regulation 1 – Application	1
Regulation 2 – Fire safety objectives and functional requirements	4
Regulation 3 – Definitions	4

Regulation 1 – Application

1. Application

- 1.1. Unless expressly provided otherwise, this chapter shall apply to ships constructed on or after 1 July 2002.
- 1.2. For the purpose of this chapter:
 - 1.2.1. the expression “ships constructed” means ships the keels of which are laid or which are at a similar stage of construction;
 - 1.2.2. the expression “all ships” means ships, irrespective of type, constructed before, on or after 1 July 2002; *as to cargo ships with a gross tonnage below 500, the expression shall, however, refer only to ships constructed on or after 1 July 2002;* and
 - 1.2.3. a cargo ship, whenever built, which is converted to a passenger ship shall be treated as a passenger ship constructed on the date on which such a conversion commences.
- 1.3. For the purpose of this chapter, the expression “a similar stage of construction” means the stage at which:
 - 1.3.1. construction identifiable with a specific ship begins; and
 - 1.3.2. assembly of that ship has commenced comprising at least 50 tonnes or 1% of the estimated mass of all structural material, whichever is less.

2. Applicable requirements to existing ships

Except for the reference in paragraphs 2.2.1 to 2.2.3, paragraph 2 shall not apply to cargo ships with a gross tonnage below 500¹ constructed before 1 July 2002.

- 2.1. Unless expressly provided otherwise, for ships constructed before 1 July 2002 the Administration shall ensure that the requirements which are applicable under chapter II-2 of the International Convention for the Safety of Life at Sea, 1974, as amended by resolutions MSC.1(XLV), MSC.6(48), MSC.13(57), MSC.22(59), MSC.24(60), MSC.27(61), MSC.31(63) and MSC.57 (67), are complied with.
- 2.2. Ships constructed before 1 July 2002 shall also comply with:
 - 2.2.1. paragraphs 3, 6.5 and 6.7 as appropriate;
 - 2.2.2. regulations 13.3.4.2 to 13.3.4.5, 13.4.3 and part E, except regulations 16.3.2.2 and 16.3.2.3 thereof, as appropriate, not later than the date of the first survey² after 1 July 2002;

¹ For cargo ships the keels of which are laid on or after 1 June 1985, but before 1 July 2002, the equivalent provisions in force are stipulated in Notice C from the Danish Register of Ships, as amended.

- 2.2.3. regulations 10.4.1.3 and 10.6.4 for new installations only;
- 2.2.4. regulation 10.5.6 not later than 1 October 2005 for passenger ships of 2,000 gross tonnage and above; and.
- 2.2.5. regulations 5.3.1.3.2 and 5.3.4 to passenger ships not later than the date of the first survey after 1 July 2008.

3. Repairs, alterations, modifications and outfitting

- 3.1. All ships which undergo repairs, alterations, modifications and outfitting related thereto shall continue to comply with at least the requirements previously applicable to these ships. Such ships, if constructed before 1 July 2002, shall, as a rule, comply with the requirements for ships constructed on or after that date to at least the same extent as they did before undergoing such repairs, alterations, modifications or outfitting.
- 3.2. Repairs, alterations and modifications which substantially alter the dimensions of a ship or the passenger accommodation spaces, or substantially increase a ship's service life and outfitting related thereto, shall meet the requirements for ships constructed on or after 1 July 2002 in so far as the Administration deems reasonable and practicable.

4. Exemptions

- 4.1. The Administration may, if it considers that the sheltered nature and conditions of the voyage are such as to render the application of any specific requirements of this chapter unreasonable or unnecessary, exempt³ from those requirements individual ships or classes of ships entitled to fly the flag of its State, provided that such ships, in the course of their voyage, do not sail at distances of more than 20 miles from the nearest land.
- 4.2. *Regardless of the provisions stipulated in paragraph 4.1, the provisions related to constructive fire integrity required of the ship shall be complied with.*
- 4.3. In the case of passenger ships which are employed in special trades for the carriage of large numbers of special trade passengers, such as the pilgrim trade, the Administration, if satisfied that it is impracticable to enforce compliance with the requirements of this chapter, may exempt such ships from those requirements, provided that they comply fully with the provisions of:
 - 4.3.1. the rules annexed to the Special Trade Passenger Ships Agreement, 1971; and
 - 4.3.2. the rules annexed to the Protocol on Space Requirements for Special Trade Passenger Ships, 1973.

5. Applicable requirements depending on ship type

Unless expressly provided otherwise:

- 5.1. requirements not referring to a specific ship type shall apply to ships of all types; and
- 5.2. requirements referring to "tankers" shall apply to tankers subject to the requirements specified in paragraph 6 below.

6. Application of requirements for tankers

- 6.1. Requirements for tankers in this chapter shall apply to tankers carrying crude oil or petroleum products having a flashpoint not exceeding 60°C (closed cup test), as determined by an approved flashpoint apparatus, and a Reid vapour pressure which is below the atmospheric pressure or other liquid products having a similar fire hazard.
- 6.2. Where liquid cargoes other than those referred to in paragraph 6.1 or liquefied gases which introduce additional fire hazards are intended to be carried, additional safety measures shall be required, having due regard to the provisions of the International Bulk Chemical Code, as defined in regulation VII/8.1, the Bulk Chemical Code, the

² Refer to MSC.1/Circ.1290 on the Unified interpretation of the term "first survey" referred to in SOLAS regulations.

³ Refer to Port State concurrence with SOLAS exemptions (MSC/Circ. 606).

International Gas Carrier Code, as defined in regulation VII/11.1, and the Gas Carrier Code, as appropriate.

- 6.2.1. A liquid cargo with a flashpoint of less than 60°C for which a regular foam fire-fighting system complying with the Fire Safety Systems Code is not effective, is considered to be a cargo introducing additional fire hazards in this context. The following additional measures are required:
 - 6.2.1.1. the foam shall be of alcohol-resistant type;
 - 6.2.1.2. the type of foam concentrates for use in chemical tankers shall be to the satisfaction of the Administration, taking into account the guidelines developed by the Organization;⁴ and
 - 6.2.1.3. the capacity and application rates of the foam extinguishing system shall comply with chapter 11 of the International Bulk Chemical Code, except that lower application rates may be accepted based on performance tests. For tankers fitted with inert gas systems, a quantity of foam concentrate sufficient for 20 min of foam generation may be accepted.⁵
- 6.2.2. For the purpose of this regulation, a liquid cargo with a vapour pressure greater than 1.013 bar absolute at 37.8°C is considered to be a cargo introducing additional fire hazards. Ships carrying such substances shall comply with paragraph 15.14 of the International Bulk Chemical Code. When ships operate in restricted areas and at restricted times, the Administration concerned may agree to waive the requirements for refrigeration systems in accordance with paragraph 15.14.3 of the International Bulk Chemical Code.
- 6.3. Liquid cargoes with a flashpoint exceeding 60°C other than oil products or liquid cargoes subject to the requirements of the International Bulk Chemical Code are considered to constitute a low fire risk, not requiring the protection of a fixed foam extinguishing system.
- 6.4. Tankers carrying petroleum products with a flashpoint exceeding 60°C (closed cup test), as determined by an approved flashpoint apparatus, shall comply with the requirements provided in regulations 10.2.1.4.4 and 10.10.2.3 and the requirements for cargo ships other than tankers, except that, in lieu of the fixed fire-extinguishing system required in regulation 10.7, they shall be fitted with a fixed deck foam system which shall comply with the provisions of the Fire Safety Systems Code.
- 6.5. Combination carriers constructed before, on or after 1 July 2002 shall not carry cargoes other than oil unless all cargo spaces are empty of oil and gas-freed or unless the arrangements provided in each case have been approved by the Administration taking into account the guidelines developed by the Organization.⁶
- 6.6. Chemical tankers and gas carriers shall comply with the requirements for tankers, except where alternative and supplementary arrangements are provided to the satisfaction of the Administration, having due regard to the provisions of the International Bulk Chemical Code and the International Gas Carrier Code, as appropriate.
- 6.7. The requirements of regulations 4.5.10.1.1 and 4.5.10.1.4 and a system for continuous monitoring of the concentration of hydrocarbon gases shall be fitted on all tankers constructed before 1 July 2002 by the date of the first scheduled dry-docking after 1 July

⁴ Refer to the Revised Guidelines for the performance and testing criteria and surveys of foam concentrates for fixed fire-extinguishing systems for chemical tankers (MSC/Circ.1312).

⁵ Refer to the Information on flashpoint and recommended fire-fighting media for chemicals to which neither the IBC nor BCH Codes apply (MSC/Circ.553).

⁶ Refer to the Guidelines for inert gas systems (MSC/ Circ.353), as amended by MSC/Circ.387.

2002, but not later than 1 July 2005. Sampling points or detector heads shall be located in suitable positions in order that potentially dangerous leakages are readily detected. When the hydrocarbon gas concentration reaches a pre-set level which shall not be higher than 10% of the lower flammable limit, a continuous audible and visual alarm signal shall be automatically effected in the pump-room and cargo control room to alert personnel to the potential hazard. However, existing monitoring systems already fitted having a pre-set level not greater than 30% of the lower flammable limit may be accepted.

Regulation 2 – Fire safety objectives and functional requirements

1. Fire safety objectives

- 1.1. The fire safety objectives of this chapter are to:
 - 1.1.1. prevent the occurrence of fire and explosion;
 - 1.1.2. reduce the risk to life caused by fire;
 - 1.1.3. reduce the risk of damage caused by fire to the ship, its cargo and the environment;
 - 1.1.4. contain, control and suppress fire and explosion in the compartment of origin; and
 - 1.1.5. provide adequate and readily accessible means of escape for passengers and crew.

2. Functional requirements

- 2.1. In order to achieve the fire safety objectives set out in paragraph 1, the following functional requirements are embodied in the regulations of this chapter as appropriate:
 - 2.1.1. division of the ship into main vertical and horizontal zones by thermal and structural boundaries;
 - 2.1.2. separation of accommodation spaces from the remainder of the ship by thermal and structural boundaries;
 - 2.1.3. restricted use of combustibile materials;
 - 2.1.4. detection of any fire in the zone of origin;
 - 2.1.5. containment and extinction of any fire in the space of origin;
 - 2.1.6. protection of means of escape and access for fire fighting;
 - 2.1.7. ready availability of fire-extinguishing appliances; and
 - 2.1.8. minimization of possibility of ignition of flammable cargo vapour.

3. Achievement of the fire safety objectives

The fire safety objectives set out in paragraph 1 shall be achieved by ensuring compliance with the prescriptive requirements specified in parts B, C, D, E or G, or by alternative design and arrangements which comply with part F. A ship shall be considered to meet the functional requirements set out in paragraph 2 and to achieve the fire safety objectives set out in paragraph 1 when either:

- 3.1. the ship's design and arrangements, as a whole, comply with the relevant prescriptive requirements in parts B, C, D, E or G;
- 3.2. the ship's design and arrangements, as a whole, have been reviewed and approved in accordance with part F; or
- 3.3. part(s) of the ship's design and arrangements have been reviewed and approved in accordance with part F and the remaining parts of the ship comply with the relevant prescriptive requirements in parts B, C, D, E or G.

Regulation 3 – Definitions

For the purpose of this chapter, unless expressly provided otherwise, the following definitions shall apply:

1. "Accommodation spaces" are those spaces used for public spaces, corridors, lavatories, cabins, offices, hospitals, cinemas, game and hobby rooms, barber shops, pantries containing no cooking appliances and similar spaces.
2. "A" class divisions are those divisions formed by bulkheads and decks which comply with the following criteria:
 - 2.1. they are constructed of steel or other equivalent material;⁷
 - 2.2. they are suitably stiffened;
 - 2.3. they are insulated with approved non-combustible materials such that the average temperature of the unexposed side will not rise more than 140°C above the original temperature, nor will the temperature, at any one point, including any joint, rise more than 180°C above the original temperature, within the time listed below:

class "A-60"	60 min
class "A-30"	30 min
class "A-15"	15 min
class "A-0"	0 min

- 2.4. they are so constructed as to be capable of preventing the passage of smoke and flame to the end of the one-hour standard fire test; and
- 2.5. the Administration required a test of a prototype bulkhead or deck in accordance with the Fire Test Procedures Code to ensure that it meets the above requirements for integrity and temperature rise.
- 2.6. *Fire insulation with soft mineral wool and equivalent material on vertical and overhead surfaces shall be secured in a solid way, e.g. by means of clips with a mutual spacing of about 300 mm and by means of wire netting, glass tissue or other suitable, non-combustible material.*
3. "Atriums" are public spaces within a single main vertical zone spanning three or more open decks.
4. "B" class divisions are those divisions formed by bulkheads, decks, ceilings or linings which comply with the following criteria:
 - 4.1. they are constructed of approved non-combustible materials and all materials used in the construction and erection of "B" class divisions are non-combustible, with the exception that combustible veneers may be permitted provided they meet other appropriate requirements of this chapter;
 - 4.2. they have an insulation value such that the average temperature of the unexposed side will not rise more than 140°C above the original temperature, nor will the temperature at any one point, including any joint, rise more than 225°C above the original temperature, within the time listed below:

class "B-15"	15 min
class "B-0"	0 min

- 4.3. they are so constructed as to be capable of preventing the passage of flame to the end of the first half hour of the standard fire test; and

⁷ Furthermore, reference is made to MSC/Circ.1005, Unified interpretations of vague expressions and other vague wording of SOLAS, chapter II-2.

- 4.4. the Administration required a test of a prototype division in accordance with the Fire Test Procedures Code to ensure that it meets the above requirements for integrity and temperature rise.
5. "Bulkhead deck" is the uppermost deck up to which the transverse watertight bulkheads are carried.
6. "Cargo area" is that part of the ship that contains cargo holds, cargo tanks, slop tanks and cargo pump-rooms including pumprooms, cofferdams, ballast and void spaces adjacent to cargo tanks and also deck areas throughout the entire length and breadth of the part of the ship over the aforementioned spaces.
7. "Cargo ship" is a ship as defined in regulation I/2(g).
8. "Cargo spaces" are spaces used for cargo, cargo oil tanks, tanks for other liquid cargo and trunks to such spaces.
9. "Central control station" is a control station in which the following control and indicator functions are centralized:
 - 9.1. fixed fire detection and fire alarm systems;
 - 9.2. automatic sprinkler, fire detection and fire alarm systems;
 - 9.3. fire door indicator panels;
 - 9.4. fire door closure;
 - 9.5. watertight door indicator panels;
 - 9.6. watertight door closures;
 - 9.7. ventilation fans;
 - 9.8. general/fire alarms;
 - 9.9. communication systems including telephones; and
 - 9.10. microphones to public address systems.
10. "C" class divisions are divisions constructed of approved non-combustible materials. They need meet neither requirements relative to the passage of smoke and flame nor limitations relative to the temperature rise. Combustible veneers are permitted provided they meet the requirements of this chapter.
11. "Chemical tanker" is a cargo ship constructed or adapted and used for the carriage in bulk of any liquid product of a flammable nature listed in chapter 17 of the International Bulk Chemical Code, as defined in regulation VII/8.1.
12. "Closed ro-ro spaces" are ro-ro spaces which are neither open ro-ro spaces nor weather decks.
13. "Closed vehicle spaces" are vehicle spaces which are neither open vehicle spaces nor weather decks.
14. "Combination carrier" is a cargo ship designed to carry both oil and solid cargoes in bulk.
15. "Combustible material" is any material other than a non-combustible material.
16. Continuous "B" class ceilings or linings are those "B" class ceilings or linings which terminate at an "A" or "B" class division.
17. "Continuously manned central control station" is a central control station which is continuously manned by a responsible member of the crew.
18. "Control stations" are those spaces in which the ship's radio or main navigating equipment or the emergency source of power is located or where the fire recording or fire control equipment is centralized. Spaces where the fire recording or fire control equipment is centralized are also considered to be a fire control station.
19. "Crude oil" is any oil occurring naturally in the earth, whether or not treated to render it suitable for transportation, and includes crude oil where certain distillate fractions may have been removed from or added to.

20. "Dangerous goods" are those goods referred to in the IMDG Code, as defined in regulation VII/1.1.
21. "Deadweight" is the difference in tonnes between the displacement of a ship in water of a specific gravity of 1.025 at the load waterline corresponding to the assigned summer freeboard and the lightweight of the ship.
22. "Fire Safety Systems Code" means the International Code for Fire Safety Systems⁸ as adopted by the Maritime Safety Committee of the Organization by resolution MSC.98(73), as may be amended by the Organization, provided that such amendments are adopted, brought into force and take effect in accordance with the provisions of article VIII of the present Convention concerning the amendment procedures applicable to the annex other than chapter I thereof.
23. "Fire Test Procedures Code" means the International Code for Application of Fire Test Procedures as adopted by the Maritime Safety Committee of the Organization by resolution MSC.61(67)⁹, as may be amended by the Organization, provided that such amendments are adopted, brought into force and take effect in accordance with the provisions of article VIII of the present Convention concerning the amendment procedures applicable to the annex other than chapter I thereof.
24. "Flashpoint" is the temperature in degrees Celsius (closed cup test) at which a product will give off enough flammable vapour to be ignited, as determined by an approved flashpoint apparatus.
25. "Gas carrier" is a cargo ship constructed or adapted and used for the carriage in bulk of any liquefied gas or other products of a flammable nature listed in chapter 19 of the International Gas Carrier Code, as defined in regulation VII/11.1.
26. "Helideck" is a purpose-built helicopter landing area located on a ship including all structure, fire-fighting appliances and other equipment necessary for the safe operation of helicopters.
27. "Helicopter facility" is a helideck including any refuelling and hangar facilities.
28. "Lightweight" is the displacement of a ship in tonnes without cargo, fuel, lubricating oil, ballast water, fresh water and feedwater in tanks, consumable stores, and passengers and crew and their effects.
29. "Low flame-spread" means that the surface thus described will adequately restrict the spread of flame, this being determined in accordance with the Fire Test Procedures Code.
30. "Machinery spaces" are machinery spaces of category A and other spaces containing propulsion machinery, boilers, oil fuel units, steam and internal combustion engines, generators and major electrical machinery, oil filling stations, refrigerating, stabilizing, ventilation and air conditioning machinery, and similar spaces, and trunks to such spaces.
31. "Machinery spaces of category A" are those spaces and trunks to such spaces which contain either:
 - 31.1. internal combustion machinery used for main propulsion;
 - 31.2. internal combustion machinery used for purposes other than main propulsion where such machinery has in the aggregate a total power output of not less than 375 kW; or
 - 31.3. any oil-fired boiler or oil fuel unit, or any oil-fired equipment other than boilers, such as inert gas generators, incinerators, etc.

⁸ Furthermore, reference is made to MSC/Circ.1005, *Unified interpretations of vague expressions and other vague wording of SOLAS, chapter II-2*.

⁹ Reference is also made to MSC/Circ.1004, *Unified interpretations of the International Code for application of Fire Test Procedures Code (FTP Code) and fire test procedures referred to in the Code as well as to MSC/Circ.1008, Revision to interpretations of the International Code for Application of Fire Test Procedures (FTP Code) and the fire test procedures referred to in the Code (MSC/Circ.916)*.

32. "Main vertical zones" are those sections into which the hull, superstructure and deckhouses are divided by "A" class divisions, the mean length and width of which on any deck does not in general exceed 40 m.
33. "Non-combustible material" is a material which neither burns nor gives off flammable vapours in sufficient quantity for self-ignition when heated to approximately 750°C, this being determined in accordance with the Fire Test Procedures Code.
34. "Oil fuel unit" is the equipment used for the preparation of oil fuel for delivery to an oil-fired boiler, or equipment used for the preparation for delivery of heated oil to an internal combustion engine, and includes any oil pressure pumps, filters and heaters dealing with oil at a pressure of more than 0.18 N/mm².
35. "Open ro-ro spaces" are those ro-ro spaces which are either open at both ends or have an opening at one end, and are provided with adequate natural ventilation effective over their entire length through permanent openings distributed in the side plating or deckhead or from above, having a total area of at least 10% of the total area of the space sides.
36. "Open vehicle spaces" are those vehicle spaces which are either open at both ends or have an opening at one end and are provided with adequate natural ventilation effective over their entire length through permanent openings distributed in the side plating or deckhead or from above, having a total area of at least 10% of the total area of the space sides.
37. "Passenger ship" is a ship as defined in regulation I/2(f).
38. "Prescriptive requirements" means the construction characteristics, limiting dimensions, or fire safety systems specified in parts B, C, D, E or G.
39. "Public spaces" are those portions of the accommodation which are used for halls, dining rooms, lounges and similar permanently enclosed spaces.
40. "Rooms containing furniture and furnishings of restricted fire risk", for the purpose of regulation 9, are those rooms containing furniture and furnishings of restricted fire risk (whether cabins, public spaces, offices or other types of accommodation) in which:
 - 40.1. case furniture such as desks, wardrobes, dressing tables, bureaux, or dressers are constructed entirely of approved non-combustible materials, except that a combustible veneer not exceeding 2 mm may be used on the working surface of such articles;
 - 40.2. free-standing furniture such as chairs, sofas, or tables are constructed with frames of non-combustible materials;
 - 40.3. draperies, curtains and other suspended textile materials have qualities of resistance to the propagation of flame not inferior to those of wool having a mass of 0.8 kg/m², this being determined in accordance with the Fire Test Procedures Code;
 - 40.4. floor coverings have low flame-spread characteristics;
 - 40.5. exposed surfaces of bulkheads, linings and ceilings have low flame-spread characteristics;
 - 40.6. upholstered furniture has qualities of resistance to the ignition and propagation of flame, this being determined in accordance with the Fire Test Procedures Code; and
 - 40.7. bedding components have qualities of resistance to the ignition and propagation of flame, this being determined in accordance with the Fire Test Procedures Code.
41. "Ro-ro spaces" are spaces not normally subdivided in any way and normally extending to either a substantial length or the entire length of the ship in which motor vehicles with fuel in their tanks for their own propulsion and/or goods (packaged or in bulk, in or on rail or road cars, vehicles (including road or rail tankers), trailers, containers, pallets, demountable tanks or in or on similar stowage units or other receptacles) can be loaded and unloaded normally in a horizontal direction.
42. "Ro-ro passenger ship" means a passenger ship with ro-ro spaces or special category spaces.

43. "Steel or other equivalent material" means any non-combustible material which, by itself or due to insulation provided, has structural and integrity properties equivalent to steel at the end of the applicable exposure to the standard fire test (e.g., aluminium alloy with appropriate insulation).
44. "Sauna" is a hot room with temperatures normally varying between 80°C and 120°C where the heat is provided by a hot surface (e.g., by an electrically heated oven). The hot room may also include the space where the oven is located and adjacent bathrooms.
45. "Service spaces" are those spaces used for galleys, pantries containing cooking appliances, lockers, mail and specie rooms, store-rooms, workshops other than those forming part of the machinery spaces, and similar spaces and trunks to such spaces.
46. "Special category spaces" are those enclosed vehicle spaces above and below the bulkhead deck, into and from which vehicles can be driven and to which passengers have access. Special category spaces may be accommodated on more than one deck provided that the total overall clear height for vehicles does not exceed 10 m.
47. "A standard fire test" is a test in which specimens of the relevant bulkheads or decks are exposed in a test furnace to temperatures corresponding approximately to the standard time-temperature curve in accordance with the test method specified in the Fire Test Procedures Code.
48. "Tanker" is a ship as defined in regulation I/2(h).
49. "Vehicle spaces" are cargo spaces intended for carriage of motor vehicles with fuel in their tanks for their own propulsion.
50. "Weather deck" is a deck which is completely exposed to the weather from above and from at least two sides.
51. "Safe area in the context of a casualty" is, from a perspective of habitability, any area(s) which is not flooded or which is outside the main vertical zone(s) in which a fire has occurred such that it can safely accommodate all persons onboard to protect them from hazards to life or health and provide them with basic services.
52. "Safety centre" is a control station dedicated to the management of emergency situations. Safety systems' operation, control and/or monitoring are an integral part of the safety centre.
53. "Cabin balcony" is an open deck space which is provided for the exclusive use of the occupants of a single cabin and has direct access from such a cabin.

Notice from the Danish Maritime Authority B – The Construction and Equipment, etc. of Ships

Chapter B II-2 B

Construction – Fire protection, fire detection and fire extinction

Regulation 4 – Probability of ignition.....	1
Regulation 5 – Fire growth potential	14
Regulation 6 – Smoke generation potential and toxicity	17

Part B – Prevention of fire and explosion

Regulation 4 – Probability of ignition

1. Purpose

The purpose of this regulation is to prevent the ignition of combustible materials or flammable liquids. For this purpose, the following functional requirements shall be met:

- 1.1. means shall be provided to control leaks of flammable liquids;
- 1.2. means shall be provided to limit the accumulation of flammable vapours;
- 1.3. the ignitability of combustible materials shall be restricted;
- 1.4. ignition sources shall be restricted;
- 1.5. ignition sources shall be separated from combustible materials and flammable liquids; and
- 1.6. the atmosphere in cargo tanks shall be maintained out of the explosive range.

2. Arrangements for oil fuel, lubrication oil and other flammable oils

2.1. Limitations in the use of oils as fuel

The following limitations shall apply to the use of oil as fuel:

- 2.1.1. except as otherwise permitted by this paragraph, no oil fuel with a flashpoint of less than 60°C shall be used;¹
- 2.1.2. in emergency generators, oil fuel with a flashpoint of not less than 43°C may be used;
- 2.1.3. the use of oil fuel having a flashpoint of less than 60°C but not less than 43°C may be permitted (e.g., for feeding the emergency fire pump's engines and the auxiliary machines which are not located in the machinery spaces of category A) subject to the following:
 - 2.1.3.1. fuel oil tanks except those arranged in double bottom compartments shall be located outside of machinery spaces of category A;
 - 2.1.3.2. provisions for the measurement of oil temperature are provided on the suction pipe of the oil fuel pump;
 - 2.1.3.3. stop valves and/or cocks are provided on the inlet side and outlet side of the oil fuel strainers; and
 - 2.1.3.4. pipe joints of welded construction or of circular cone type or spherical type union joint are applied as much as possible; and

¹ Refer to the Recommended procedures to prevent the illegal or accidental use of low flashpoint cargo oil as fuel adopted by the Organization by resolution A.565(14).

- 2.1.4. in cargo ships the use of fuel having a lower flashpoint than otherwise specified in paragraph 2.1, for example crude oil, may be permitted provided that such fuel is not stored in any machinery space and subject to the approval by the Administration of the complete installation.

2.2. Arrangements for oil fuel

In a ship in which oil fuel is used, the arrangements for the storage, distribution and utilization of the oil fuel shall be such as to ensure the safety of the ship and persons on board and shall at least comply with the following provisions.

2.2.1. Location of oil fuel systems

As far as practicable, parts of the oil fuel system containing heated oil (*oil above 60° C*) under pressure exceeding 0.18 N/ mm² shall not be placed in a concealed position such that defects and leakage cannot readily be observed. The machinery spaces in way of such parts of the oil fuel system shall be adequately illuminated.

2.2.2. Ventilation of machinery spaces

The ventilation of machinery spaces shall be sufficient under normal conditions to prevent accumulation of oil vapour.

2.2.3. Oil fuel tanks

2.2.3.1. Fuel oil, lubrication oil and other flammable oils shall not be carried in forepeak tanks.

2.2.3.2. As far as practicable, oil fuel tanks shall be part of the ship's structure and shall be located outside machinery spaces of category A. Where oil fuel tanks, other than double bottom tanks, are necessarily located adjacent to or within machinery spaces of category A, at least one of their vertical sides shall be contiguous to the machinery space boundaries, and shall preferably have a common boundary with the double bottom tanks, and the area of the tank boundary common with the machinery spaces shall be kept to a minimum. Where such tanks are situated within the boundaries of machinery spaces of category A they shall not contain oil fuel having a flashpoint of less than 60°C. In general, the use of free-standing oil fuel tanks shall be avoided. When such tanks are employed their use shall be prohibited in category A machinery spaces on passenger ships. Where permitted, they shall be placed in an oil-tight spill tray of ample size having a suitable drain pipe leading to a suitably sized spill oil tank.

2.2.3.3. No oil fuel tank shall be situated where spillage or leakage therefrom can constitute a fire or explosion hazard by falling on heated surfaces.

2.2.3.4. Oil fuel pipes, which, if damaged, would allow oil to escape from a storage, settling or daily service tank having a capacity of 500l and above situated above the double bottom, shall be fitted with a cock or valve directly on the tank capable of being closed from a safe position outside the space concerned in the event of a fire occurring in the space in which such tanks are situated. In the special case of deep tanks situated in any shaft or pipe tunnel or similar space, valves on the tank shall be fitted, but control in the event of fire may be effected by means of an additional valve on the pipe or pipes outside the tunnel or similar space. If such an additional valve is fitted in the machinery space, it shall be operated from a position outside this space. The controls for remote operation of the valve for the emergency generator fuel tank shall be in a separate

location from the controls for remote operation of other valves for tanks located in machinery spaces.

2.2.3.5. Safe and efficient means of ascertaining the amount of oil fuel contained in any oil fuel tank shall be provided.

2.2.3.5.1. Where sounding pipes are used, they shall not terminate in any space where the risk of ignition of spillage from the sounding pipe might arise. In particular, they shall not terminate in passenger or crew spaces. As a general rule, they shall not terminate in machinery spaces. However, where the Administration considers that these latter requirements are impracticable, it may permit termination of sounding pipes in machinery spaces on condition that all of the following requirements are met:

2.2.3.5.1.1. an oil-level gauge is provided meeting the requirements of paragraph 2.2.3.5.2;

2.2.3.5.1.2. the sounding pipes terminate in locations remote from ignition hazards unless precautions are taken, such as the fitting of effective screens, to prevent the oil fuel in the case of spillage through the terminations of the sounding pipes from coming into contact with a source of ignition; and

2.2.3.5.1.3. the terminations of sounding pipes are fitted with self-closing blanking devices and with a small-diameter self-closing control cock located below the blanking device for the purpose of ascertaining before the blanking device is opened that oil fuel is not present. Provisions shall be made so as to ensure that any spillage of oil fuel through the control cock involves no ignition hazard.

2.2.3.5.2. Other oil-level gauges may be used in place of sounding pipes subject to the following conditions:

2.2.3.5.2.1. in passenger ships, such gauges shall not require penetration below the top of the tank and their failure or overfilling of the tanks shall not permit release of fuel; and

2.2.3.5.2.2. in cargo ships, the failure of such gauges or overfilling of the tank shall not permit release of fuel into the space. The use of cylindrical gauge glasses is prohibited. The Administration may permit the use of oil-level gauges with flat glasses and self-closing valves between the gauges and fuel tanks.

2.2.3.5.3. The means prescribed in paragraph 2.2.3.5.2 which are acceptable to the Administration shall be maintained in the proper condition to ensure their continued accurate functioning in service.

2.2.4. Prevention of overpressure

Provisions shall be made to prevent overpressure in any oil tank or in any part of the oil fuel system, including the filling pipes served by pumps on board. Air and overflow pipes and relief valves shall discharge to a position where there is no risk of fire or explosion from the emergence of oils and vapour and shall not lead into crew spaces, passenger spaces nor into special category spaces, closed ro-ro cargo spaces, machinery spaces or similar spaces.

2.2.5. Oil fuel piping

2.2.5.1. Oil fuel pipes and their valves and fittings shall be of steel or other approved material, except that restricted use of flexible pipes shall be permissible in positions where the Administration is satisfied that they are necessary². Such flexible pipes and end attachments shall be of approved fire-resisting materials of adequate strength and shall be constructed to the satisfaction of the Administration. For valves fitted to oil fuel tanks and under static pressure, steel or spheroidal-graphite cast iron may be accepted. However, ordinary cast iron valves may be used in piping systems where the design pressure is lower than 7 bar and the design temperature is below 60°C.

2.2.5.2. External high-pressure fuel delivery lines between the high-pressure fuel pumps and fuel injectors shall be protected with a jacketed piping system capable of containing fuel from a high-pressure line failure. A jacketed pipe incorporates an outer pipe into which the high-pressure fuel pipe is placed, forming a permanent assembly. The jacketed piping system shall include a means for collection of leakages and arrangements shall be provided with an alarm in case of a fuel line failure.

2.2.5.3. Oil fuel lines shall not be located immediately above or near units of high temperature, including boilers, steam pipelines, exhaust manifolds, silencers or other equipment required to be insulated by paragraph 2.2.6. As far as practicable, oil fuel lines shall be arranged far apart from hot surfaces, electrical installations or other sources of ignition and shall be screened or otherwise suitably protected to avoid oil spray or oil leakage onto the sources of ignition. The number of joints in such piping systems shall be kept to a minimum.

2.2.5.4. Components of a diesel engine fuel system shall be designed considering the maximum peak pressure which will be experienced in service, including any high-pressure pulses which are generated and transmitted back into the fuel supply and spill lines by the action of fuel injection pumps. Connections within the fuel supply and spill lines shall be constructed having regard to their ability to prevent pressurized oil fuel leaks while in service and after maintenance.

2.2.5.5. In multi-engine installations which are supplied from the same fuel source, means of isolating the fuel supply and spill piping to individual engines shall be provided. The means of isolation shall not affect the operation of the other engines and shall be operable from a position not rendered inaccessible by a fire on any of the engines.

² Refer to recommendations published by the International Organization for Standardization, in particular publications ISO 15540:1999, Fire resistance of hose assemblies – test methods and ISO 15541:1999, Fire resistance of hose assemblies – requirements for the test bench.

- 2.2.5.6. Where the Administration may permit the conveying of oil and combustible liquids through accommodation and service spaces, the pipes conveying oil or combustible liquids shall be of a material approved by the Administration having regard to the fire risk.
- 2.2.6. Protection of high-temperature surfaces
 - 2.2.6.1. Surfaces with temperatures above 220°C which may be impinged as a result of a fuel system failure shall be properly insulated.
 - 2.2.6.2. Precautions shall be taken to prevent any oil that may escape under pressure from any pump, filter or heater from coming into contact with heated surfaces.
- 2.3. **Arrangements for lubricating oil**
 - 2.3.1. The arrangements for the storage, distribution and utilization of oil used in pressure lubrication systems shall be such as to ensure the safety of the ship and persons on board. The arrangements made in machinery spaces of category A, and whenever practicable in other machinery spaces, shall at least comply with the provisions of paragraphs 2.2.1, 2.2.3.3, 2.2.3.4, 2.2.3.5, 2.2.4, 2.2.5.1, 2.2.5.3 and 2.2.6, except that:
 - 2.3.1.1. this does not preclude the use of sightflow glasses in lubricating systems provided that they are shown by testing to have a suitable degree of fire resistance; and
 - 2.3.1.2. sounding pipes may be authorized in machinery spaces; however, the requirements of paragraphs 2.2.3.5.1.1 and 2.2.3.5.1.3 need not be applied on condition that the sounding pipes are fitted with appropriate means of closure.
 - 2.3.2. The provisions of paragraph 2.2.3.4 shall also apply to lubricating oil tanks except those having a capacity less than 500 l, storage tanks on which valves are closed during the normal operation mode of the ship, or where it is determined that an unintended operation of a quick-closing valve on the oil lubricating tank would endanger the safe operation of the main propulsion and essential auxiliary machinery.
- 2.4. **Arrangements for other flammable oils**

The arrangements for the storage, distribution and utilization of other flammable oils employed under pressure in power transmission systems, control and activating systems and heating systems shall be such as to ensure the safety of the ship and persons on board. Suitable oil collecting arrangements for leaks shall be fitted below hydraulic valves and cylinders. In locations where means of ignition are present, such arrangements shall at least comply with the provisions of paragraphs 2.2.3.3, 2.2.3.5, 2.2.5.3 and 2.2.6 and with the provisions of paragraphs 2.2.4 and 2.2.5.1 in respect of strength and construction.
- 2.5. **Arrangements for oil fuel in periodically unattended machinery spaces**

In addition to the requirements of paragraphs 2.1 to 2.4, the oil fuel and lubricating oil systems in a periodically unattended machinery space shall comply with the following:

 - 2.5.1. where daily service oil fuel tanks are filled automatically, or by remote control, means shall be provided to prevent overflow spillages. Other equipment which treats flammable liquids automatically (e.g., oil fuel purifiers) which, whenever practicable, shall be installed in a special space reserved for purifiers and their heaters, shall have arrangements to prevent overflow spillages; and

2.5.2. where daily service oil fuel tanks or settling tanks are fitted with heating arrangements, a high temperature alarm shall be provided if the flashpoint of the oil fuel can be exceeded.

3. Arrangements for gaseous fuel for domestic purposes

Gaseous fuel systems used for domestic purposes shall be approved by the Administration. Storage of gas bottles shall be located on the open deck or in a well ventilated space which opens only to the open deck.

4. Miscellaneous items of ignition sources and ignitability

4.1. Electric radiators

Electric radiators, if used, shall be fixed in position and so constructed as to reduce fire risks to a minimum. No such radiators shall be fitted with an element so exposed that clothing, curtains, or other similar materials can be scorched or set on fire by heat from the element.

4.2. Waste receptacles

Waste receptacles shall be constructed of noncombustible materials with no openings in the sides or bottom.

4.3. Insulation surfaces protected against oil penetration

In spaces where penetration of oil products is possible, the surface of insulation shall be impervious to oil or oil vapours.

4.4. Primary deck coverings

Primary deck coverings, if applied within accommodation and service spaces and control stations or if applied on cabin balconies of passenger ships constructed on or after 1 July 2008, shall be of approved material which will not readily ignite, this being determined in accordance with the Fire Test Procedures Code.

5. Cargo areas of tankers

5.1. Separation of cargo oil tanks

5.1.1. Cargo pump-rooms, cargo tanks, slop tanks and cofferdams shall be positioned forward of machinery spaces. However, oil fuel bunker tanks need not be forward of machinery spaces. Cargo tanks and slop tanks shall be isolated from machinery spaces by cofferdams, cargo pump-rooms, oil bunker tanks or ballast tanks. Pump-rooms containing pumps and their accessories for ballasting those spaces situated adjacent to cargo tanks and slop tanks and pumps for oil fuel transfer shall be considered as equivalent to a cargo pump-room within the context of this regulation provided that such pump-rooms have the same safety standard as that required for cargo pump-rooms. Pumprooms intended solely for ballast or oil fuel transfer, however, need not comply with the requirements of regulation 10.9. The lower portion of the pump-room may be recessed into machinery spaces of category A to accommodate pumps, provided that the deck head of the recess is in general not more than one third of the moulded depth above the keel, except that in the case of ships of not more than 25,000 tonnes deadweight, where it can be demonstrated that for reasons of access and satisfactory piping arrangements this is impracticable, the Administration may permit a recess in excess of such height, but not exceeding one half of the moulded depth above the keel.

5.1.2. Main cargo control stations, control stations, accommodation and service spaces (excluding isolated cargo handling gear lockers) shall be positioned aft of cargo tanks, slop tanks, and spaces which isolate cargo or slop tanks from machinery spaces, but not necessarily aft of the oil fuel bunker tanks and ballast tanks, and shall be arranged in such a way that a single failure of a deck or bulkhead shall not

permit the entry of gas or fumes from the cargo tanks into main cargo control stations, control stations, or accommodation and service spaces. A recess provided in accordance with paragraph 5.1.1 need not be taken into account when the position of these spaces is being determined.

5.1.3. However, where deemed necessary, the Administration may permit main cargo control stations, control stations, accommodation and service spaces forward of the cargo tanks, slop tanks and spaces which isolate cargo and slop tanks from machinery spaces, but not necessarily forward of oil fuel bunker tanks or ballast tanks. Machinery spaces, other than those of category A, may be permitted forward of the cargo tanks and slop tanks provided they are isolated from the cargo tanks and slop tanks by cofferdams, cargo pumprooms, oil fuel bunker tanks or ballast tanks, and have at least one portable fire extinguisher. In cases where they contain internal combustion machinery, one approved foam-type extinguisher of at least 45 *l* capacity or equivalent shall be arranged in addition to portable fire extinguishers. If operation of a semiportable fire extinguisher is impracticable, this fire extinguisher may be replaced by two additional portable fire extinguishers. Main cargo control stations, control stations and accommodation and service spaces shall be arranged in such a way that a single failure of a deck or bulkhead shall not permit the entry of gas or fumes from the cargo tanks into such spaces. In addition, where deemed necessary for the safety or navigation of the ship, the Administration may permit machinery spaces containing internal combustion machinery not being main propulsion machinery having an output greater than 375 kW to be located forward of the cargo area provided the arrangements are in accordance with the provisions of this paragraph.

5.1.4. In combination carriers only:

5.1.4.1. The slop tanks shall be surrounded by cofferdams except where the boundaries of the slop tanks are part of the hull, main cargo deck, cargo pump-room bulkhead or oil fuel bunker tank. These cofferdams shall not be open to a double bottom, pipe tunnel, pump-room or other enclosed space, nor shall they be used for cargo or ballast and shall not be connected to piping systems serving oil cargo or ballast. Means shall be provided for filling the cofferdams with water and for draining them. Where the boundary of a slop tank is part of the cargo pump-room bulkhead, the pump-room shall not be open to the double bottom, pipe tunnel or other enclosed space; however, openings provided with gastight bolted covers may be permitted;

5.1.4.2. Means shall be provided for isolating the piping connecting the pump-room with the slop tanks referred to in paragraph 5.1.4.1. The means of isolation shall consist of a valve followed by a spectacle flange or a spool piece with appropriate blank flanges. This arrangement shall be located adjacent to the slop tanks, but where this is unreasonable or impracticable, it may be located within the pump-room directly after the piping penetrates the bulkhead. A separate permanently installed pumping and piping arrangement incorporating a manifold, provided with a shut-off valve and a blank flange, shall be provided for discharging the contents of the slop tanks directly to the open deck for disposal to shore reception facilities when the ship is in the dry cargo mode. When the transfer system is used for slop transfer in the dry cargo

mode, it shall have no connection to other systems. Separation from other systems by means of removal of spool pieces may be accepted;

- 5.1.4.3. Hatches and tank cleaning openings to slop tanks shall only be permitted on the open deck and shall be fitted with closing arrangements. Except where they consist of bolted plates with bolts at watertight spacing, these closing arrangements shall be provided with locking arrangements under the control of the responsible ship's officer; and
- 5.1.4.4. Where cargo wing tanks are provided, cargo oil lines below deck shall be installed inside these tanks. However, the Administration may permit cargo oil lines to be placed in special ducts provided these are capable of being adequately cleaned and ventilated to the satisfaction of the Administration. Where cargo wing tanks are not provided, cargo oil lines below deck shall be placed in special ducts.
- 5.1.5. Where the fitting of a navigation position above the cargo area is shown to be necessary, it shall be for navigation purposes only and it shall be separated from the cargo tank deck by means of an open space with a height of at least 2 m. The fire protection requirements for such a navigation position shall be those required for control stations, as specified in regulation 9.2.4.2 and other provisions for tankers, as applicable.
- 5.1.6. Means shall be provided to keep deck spills away from the accommodation and service areas. This may be accomplished by provision of a permanent continuous coaming of a height of at least 300 mm, extending from side to side. Special consideration shall be given to the arrangements associated with stern loading.

5.2. **Restriction on boundary openings**

- 5.2.1. Except as permitted in paragraph 5.2.2, access doors, air inlets and openings to accommodation spaces, service spaces, control stations and machinery spaces shall not face the cargo area. They shall be located on the transverse bulkhead not facing the cargo area or on the outboard side of the superstructure or deckhouse at a distance of at least 4% of the length of the ship, but not less than 3 m from the end of the superstructure or deckhouse facing the cargo area. This distance need not exceed 5 m.
- 5.2.2. The Administration may permit access doors in boundary bulkheads facing the cargo area or within the 5 m limits specified in paragraph 5.2.1, to main cargo control stations and to such service spaces used as provision rooms, store-rooms and lockers, provided they do not give access directly or indirectly to any other space containing or providing for accommodation, control stations or service spaces such as galleys, pantries or workshops, or similar spaces containing sources of vapour ignition. The boundary of such a space shall be insulated to "A-60" class standard, with the exception of the boundary facing the cargo area. Bolted plates for the removal of machinery may be fitted within the limits specified in paragraph 5.2.1. Wheelhouse doors and windows may be located within the limits specified in paragraph 5.2.1 so long as they are designed to ensure that the wheelhouse can be made rapidly and efficiently gastight and vapourtight.
- 5.2.3. Windows and sidescuttles facing the cargo area and on the sides of the superstructures and deckhouses within the limits specified in paragraph 5.2.1 shall be of the fixed (non-opening) type. Such windows and sidescuttles, except wheelhouse windows, shall be constructed to "A-60" class standard, except that

“A-0” class standards is acceptable for windows and sidescuttles outside the limit specified in regulation 9.2.4.2.5.

- 5.2.4. Where there is permanent access from a pipe tunnel to the main pump-room, a watertight door shall be fitted complying with the requirements of regulation II-1/13-1.2 and, in addition, with the following:
 - 5.2.4.1. in addition to the bridge operation, the watertight door shall be capable of being manually closed from outside the main pump-room entrance; and
 - 5.2.4.2. the watertight door shall be kept closed during normal operations of the ship except when access to the pipe tunnel is required.
- 5.2.5. Permanent approved gastight lighting enclosures for illuminating cargo pump-rooms may be permitted in bulkheads and decks separating cargo pump-rooms and other spaces provided they are of adequate strength and the integrity and gastightness of the bulkhead or deck is maintained.
- 5.2.6. 5.2.6 The arrangement of ventilation inlets and outlets and other deckhouse and superstructure boundary space openings shall be such as to complement the provisions of paragraph 5.3 and regulation 11.6. Such vents, especially for machinery spaces, shall be situated as far aft as practicable. Due consideration in this regard shall be given when the ship is equipped to load or discharge at the stern. Sources of ignition such as electrical equipment shall be so arranged as to avoid an explosion hazard.

5.3. **Cargo tank venting**

5.3.1. **General requirements**

The venting systems of cargo tanks shall be entirely distinct from the air pipes of the other compartments of the ship. The arrangements and position of openings in the cargo tank deck from which emission of flammable vapours can occur shall be such as to minimize the possibility of flammable vapours being admitted to enclosed spaces containing a source of ignition, or collecting in the vicinity of deck machinery and equipment which may constitute an ignition hazard. In accordance with this general principle, the criteria in paragraphs 5.3.2 to 5.3.5 and regulation 11.6 will apply.

5.3.2. **Venting arrangements**

- 5.3.2.1. The venting arrangements in each cargo tank may be independent or combined with other cargo tanks and may be incorporated into the inert gas piping.
- 5.3.2.2. Where the arrangements are combined with other cargo tanks, either stop valves or other acceptable means shall be provided to isolate each cargo tank. Where stop valves are fitted, they shall be provided with locking arrangements which shall be under the control of the responsible ship's officer. There shall be a clear visual indication of the operational status of the valves or other acceptable means. Where tanks have been isolated, it shall be ensured that relevant isolating valves are opened before cargo loading or ballasting or discharging of those tanks is commenced. Any isolation must continue to permit the flow caused by thermal variations in a cargo tank in accordance with regulation 11.6.1.1.
- 5.3.2.3. If cargo loading and ballasting or discharging of a cargo tank or cargo tank group which is isolated from a common venting system is intended, that cargo tank or cargo tank group shall be fitted with a means for over-pressure or under-pressure protection as required in regulation 11.6.3.2.

5.3.2.4. The venting arrangements shall be connected to the top of each cargo tank and shall be self-draining to the cargo tanks under all normal conditions of trim and list of the ship. Where it may not be possible to provide self-draining lines, permanent arrangements shall be provided to drain the vent lines to a cargo tank.

5.3.3. Safety devices in venting systems'

The venting system shall be provided with devices to prevent the passage of flame into the cargo tanks. The design, testing and locating of these devices shall comply with the requirements established by the Administration based on the guidelines developed by the Organization³. Ullage openings shall not be used for pressure equalization. They shall be provided with self-closing and tightly sealing covers. Flame arresters and screens are not permitted in these openings.

5.3.4. Vent outlets for cargo handling and ballasting

5.3.4.1. Vent outlets for cargo loading, discharging and ballasting required by regulation 11.6.1.2 shall:

5.3.4.1.1. permit the free flow of vapour mixtures; or

5.3.4.1.2. permit the throttling of the discharge of the vapour mixtures to achieve a velocity of not less than 30 m/s;

5.3.4.1.2.1. be so arranged that the vapour mixture is discharged vertically upwards;

5.3.4.1.2.2. where the method is by free flow of vapour mixtures, be such that the outlet shall be not less than 6 m above the cargo tank deck or fore and aft gangway if situated within 4 m of the gangway and located not less than 10 m measured horizontally from the nearest air intakes and openings to enclosed spaces containing a source of ignition and from deck machinery, which may include anchor windlass and chain locker openings, and equipment which may constitute an ignition hazard; and

5.3.4.1.2.3. where the method is by high-velocity discharge, be located at a height not less than 2 m above the cargo tank deck and not less than 10 m measured horizontally from the nearest air intakes and openings to enclosed spaces containing a source of ignition and from deck machinery, which may include anchor windlass and chain locker openings, and equipment which may constitute an ignition hazard. These outlets shall be provided with high-velocity devices of an approved type.

5.3.4.2. The arrangements for the venting of vapours displaced from the cargo tanks during loading and ballasting shall comply with paragraph 5.3 and

³ Refer to the Revised standards for the design, testing and locating of devices to prevent the passage of flame into cargo tanks in tankers (MSC/Circ.677), as amended by MSC/ Circ.1009, and to the Revised factors to be taken into consideration when designing cargo tank venting and gasfreeing arrangements (MSC/Circ.731).

regulation 11.6 and shall consist of either one or more mast risers, or a number of high-velocity vents. The inert gas supply main may be used for such venting.

5.3.5. Isolation of slop tanks in combination carriers

In combination carriers, the arrangements for isolating slop tanks containing oil or oil residues from other cargo tanks shall consist of blank flanges which will remain in position at all times when cargoes other than liquid cargoes referred to in regulation 1.6.1 are carried.

5.4. **Ventilation**

5.4.1. Ventilation systems in cargo pump-rooms

Cargo pump-rooms shall be mechanically ventilated and discharges from the exhaust fans shall be led to a safe place on the open deck. The ventilation of these rooms shall have sufficient capacity to minimize the possibility of accumulation of flammable vapours. The number of air changes shall be at least 20 per hour, based upon the gross volume of the space. The air ducts shall be arranged so that all of the space is effectively ventilated. The ventilation shall be of the suction type using fans of the non-sparking type.

5.4.2. Ventilation systems in combination carriers

In combination carriers, cargo spaces and any enclosed spaces adjacent to cargo spaces shall be capable of being mechanically ventilated. The mechanical ventilation may be provided by portable fans. An approved fixed gas warning system capable of monitoring flammable vapours shall be provided in cargo pump-rooms, pipe ducts and cofferdams, as referred to in paragraph 5.1.4, adjacent to slop tanks. Suitable arrangements shall be made to facilitate measurement of flammable vapours in all other spaces within the cargo area. Such measurements shall be made possible from the open deck or easily accessible positions.

5.5. **Inert gas systems**

5.5.1. Application

5.5.1.1. For tankers of 20,000 tonnes deadweight and upwards, the protection of the cargo tanks shall be achieved by a fixed inert gas system in accordance with the requirements of the Fire Safety Systems Code, except that, in lieu of the above, the Administration, after having given consideration to the ship's arrangement and equipment, may accept other fixed installations if they afford protection equivalent to the above, in accordance with regulation I/5. The requirements for alternative fixed installations shall comply with the requirements in paragraph 5.5.4.

5.5.1.2. Tankers operating with a cargo tank cleaning procedure using crude oil washing shall be fitted with an inert gas system complying with the Fire Safety Systems Code and with fixed tank washing machines.

5.5.1.3. Tankers required to be fitted with inert gas systems shall comply with the following provisions:

5.5.1.3.1. double hull spaces shall be fitted with suitable connections for the supply of inert gas;

5.5.1.3.2. where hull spaces are connected to a permanently fitted inert gas distribution system, means shall be provided to prevent hydrocarbon gases from the cargo tanks entering the double hull spaces through the system; and

- 5.5.1.3.3. where such spaces are not permanently connected to an inert gas distribution system, appropriate means shall be provided to allow connection to the inert gas main.
- 5.5.2. Inert gas systems of chemical tankers and gas carriers
The requirements for inert gas systems contained in the Fire Safety Systems Code need not be applied to:
- 5.5.2.1. chemical tankers and gas carriers when carrying cargoes described in regulation 1.6.1, provided that they comply with the requirements for inert gas systems on chemical tankers established by the Administration, based on the guidelines developed by the Organization⁴; or
- 5.5.2.2. chemical tankers and gas carriers when carrying flammable cargoes other than crude oil or petroleum products such as cargoes listed in chapters 17 and 18 of the International Bulk Chemical Code, provided that the capacity of tanks used for their carriage does not exceed 3,000 m³ and the individual nozzle capacities of tank washing machines do not exceed 17.5 m³/h and the total combined throughput from the number of machines in use in a cargo tank at any one time does not exceed 110 m³/h.
- 5.5.3. **General requirements for inert gas systems**
- 5.5.3.1. The inert gas system shall be capable of inerting, purging and gas-freeing empty tanks and maintaining the atmosphere in cargo tanks with the required oxygen content.
- 5.5.3.2. The inert gas system referred to in paragraph 5.5.3.1 shall be designed, constructed and tested in accordance with the Fire Safety Systems Code.
- 5.5.3.3. Tankers fitted with a fixed inert gas system shall be provided with a closed ullage system.
- 5.5.4. Requirements for equivalent systems
- 5.5.4.1. Where an installation equivalent to a fixed inert gas system is installed, it shall
- 5.5.4.1.1. be capable of preventing dangerous accumulations of explosive mixtures in intact cargo tanks during normal service throughout the ballast voyage and necessary in-tank operations; and
- 5.5.4.1.2. be so designed as to minimize the risk of ignition from the generation of static electricity by the system itself.
- 5.6. **Inerting, purging and gas-freeing**
- 5.6.1. Arrangements for purging and/or gas-freeing shall be such as to minimize the hazards due to dispersal of flammable vapours in the atmosphere and to flammable mixtures in a cargo tank.
- 5.6.2. The procedure for cargo tank purging and/or gasfreeing shall be carried out in accordance with regulation 16.3.2.
- 5.6.3. The arrangements for inerting, purging or gasfreeing of empty tanks as required in paragraph 5.5.3.1 shall be to the satisfaction of the Administration and shall be such that the accumulation of hydrocarbon vapours in pockets formed by the internal structural members in a tank is minimized and that:

⁴ Refer to the Regulation for inert gas systems on chemical tankers adopted by the Organization by resolution A.567(14).

- 5.6.3.1. on individual cargo tanks, the gas outlet pipe, if fitted, shall be positioned as far as practicable from the inert gas/air inlet and in accordance with paragraph 5.3 and regulation 11.6. The inlet of such outlet pipes may be located either at deck level or at not more than 1 m above the bottom of the tank;
- 5.6.3.2. the cross-sectional area of such gas outlet pipe referred to in paragraph 5.6.3.1 shall be such that an exit velocity of at least 20 m/s can be maintained when any three tanks are being simultaneously supplied with inert gas. Their outlets shall extend not less than 2 m above deck level; and
- 5.6.3.3. each gas outlet referred to in paragraph 5.6.3.2 shall be fitted with suitable blanking arrangements.

5.7. Gas measurement

5.7.1. Portable instrument

Tankers shall be equipped with at least one portable instrument for measuring flammable vapour concentrations, together with a sufficient set of spares. Suitable means shall be provided for the calibration of such instruments.

5.7.2. Arrangements for gas measurement in double hull spaces and double bottom spaces

5.7.2.1. Suitable portable instruments for measuring oxygen and flammable vapour concentrations shall be provided. In selecting these instruments, due attention shall be given to their use in combination with the fixed gas sampling line systems referred to in paragraph 5.7.2.2.

5.7.2.2. Where the atmosphere in double hull spaces cannot be reliably measured using flexible gas sampling hoses, such spaces shall be fitted with permanent gas sampling lines. The configuration of gas sampling lines shall be adapted to the design of such spaces.

5.7.2.3. The materials of construction and the dimensions of gas sampling lines shall be such as to prevent restriction. Where plastic materials are used, they shall be electrically conductive.

5.8. Air supply to double hull spaces and double bottom spaces

Double hull spaces and double bottom spaces shall be fitted with suitable connections for the supply of air.

5.9. Protection of cargo area

Drip pans for collecting cargo residues in cargo lines and hoses shall be provided in the area of pipe and hose connections under the manifold area. Cargo hoses and tank washing hoses shall have electrical continuity over their entire lengths, including couplings and flanges (except shore connections), and shall be earthed for removal of electrostatic charges.

5.10. Protection of cargo pump-rooms

5.10.1. In tankers:

5.10.1.1. cargo pumps, ballast pumps and stripping pumps, installed in cargo pumprooms and driven by shafts passing through pump-room bulkheads shall be fitted with temperature sensing devices for bulkhead shaft glands, bearings and pump casings. A continuous audible and visual alarm signal shall be automatically effected in the cargo control room or the pump control station;

5.10.1.2. lighting in cargo pump-rooms, except emergency lighting, shall be interlocked with ventilation such that the ventilation shall be in operation

- when switching on the lighting. Failure of the ventilation system shall not cause the lighting to go out;
- 5.10.1.3. a system for continuous monitoring of the concentration of hydrocarbon gases shall be fitted. Sampling points or detector heads shall be located in suitable positions in order that potentially dangerous leakages are readily detected. When the hydrocarbon gas concentration reaches a pre-set level, which shall not be higher than 10% of the lower flammable limit, a continuous audible and visual alarm signal shall be automatically effected in the pump-room, engine control room, cargo control room and navigation bridge to alert personnel to the potential hazard; and
- 5.10.1.4. all pump-rooms shall be provided with bilge level monitoring devices together with appropriately located alarms.

Regulation 5 – Fire growth potential

1. Purpose

The purpose of this regulation is to limit the fire growth potential in every space of the ship. For this purpose, the following functional requirements shall be met:

- 1.1. means of control for the air supply to the space shall be provided;
- 1.2. means of control for flammable liquids in the space shall be provided; and
- 1.3. the use of combustible materials shall be restricted.

2. Control of air supply and flammable liquid to the space

2.1. Closing appliances and stopping devices of ventilation

- 2.1.1. The main inlets and outlets of all ventilation systems shall be capable of being closed from outside the spaces being ventilated. The means of closing shall be easily accessible as well as prominently and permanently marked and shall indicate whether the shutoff is open or closed.
- 2.1.2. Power ventilation of accommodation spaces, service spaces, cargo spaces, control stations and machinery spaces shall be capable of being stopped from an easily accessible position outside the space being served. This position shall not be readily cut off in the event of a fire in the spaces served.
- 2.1.3. In passenger ships carrying more than 36 passengers, power ventilation, except machinery space and cargo space ventilation and any alternative system which may be required under regulation 8.2, shall be fitted with controls so grouped that all fans may be stopped from either of two separate positions which shall be situated as far apart as practicable. Fans serving power ventilation systems to cargo spaces shall be capable of being stopped from a safe position outside such spaces.

2.2. Means of control in machinery spaces

- 2.2.1. Means of control shall be provided for opening and closure of skylights, closure of openings in funnels which normally allow exhaust ventilation and closure of ventilator dampers.
- 2.2.2. Means of control shall be provided for stopping ventilating fans. Controls provided for the power ventilation serving machinery spaces shall be grouped so as to be operable from two positions, one of which shall be outside such spaces. The means provided for stopping the power ventilation of the machinery spaces shall be entirely separate from the means provided for stopping ventilation of other spaces.
- 2.2.3. Means of control shall be provided for stopping forced and induced draught fans, oil fuel transfer pumps, oil fuel unit pumps, lubricating oil service pumps, thermal

oil circulating pumps and oil separators (purifiers). However, paragraphs 2.2.4 and 2.2.5 need not apply to oily water separators.

2.2.4. The controls required in paragraphs 2.2.1 to 2.2.3 and in regulation 4.2.2.3.4 shall be located outside the space concerned so they will not be cut off in the event of fire in the space they serve.

2.2.5. In passenger ships, the controls required in paragraphs 2.2.1 to 2.2.4 and in regulations 8.3.3 and 9.5.2.3 and the controls for any required fire-extinguishing system shall be situated at one control position or grouped in as few positions as possible to the satisfaction of the Administration. Such positions shall have a safe access from the open deck.

2.3. Additional requirements for means of control in periodically unattended machinery spaces

2.3.1. For periodically unattended machinery spaces, the Administration shall give special consideration to maintaining the fire integrity of the machinery spaces, the location and centralization of the fire-extinguishing system controls, the required shutdown arrangements (e. g., ventilation, fuel pumps, etc.) and that additional fire-extinguishing appliances and other fire-fighting equipment and breathing apparatus may be required.

2.3.2. In passenger ships, these requirements shall be at least equivalent to those of machinery spaces normally attended.

3. Fire protection materials

3.1. Use of non-combustible materials

3.1.1. Insulating materials

Insulating materials shall be non-combustible, except in cargo spaces, mail rooms, baggage rooms and refrigerated compartments of service spaces. Vapour barriers and adhesives used in conjunction with insulation, as well as the insulation of pipe fittings for cold service systems, need not be of non-combustible materials, but they shall be kept to the minimum quantity practicable and their exposed surfaces shall have low flame-spread characteristics.

3.1.2. Ceilings and linings

3.1.2.1. In passenger ships, except in cargo spaces, all linings, grounds, draught stops and ceilings shall be of non-combustible material except in mail rooms, baggage rooms, saunas or refrigerated compartments of service spaces.

3.1.2.2. In cargo ships, all linings, ceilings, draught stops and their associated grounds shall be of non-combustible materials in the following spaces:

3.1.2.2.1. in accommodation and service spaces and control stations for ships where method IC is specified as referred to in regulation 9.2.3.1; and

3.1.2.2.2. in corridors and stairway enclosures serving accommodation and service spaces and control stations for ships where methods IIC or IIIC are specified as referred to in regulation 9.2.3.1.

3.1.3. Partial bulkheads and decks on passenger ships

3.1.3.1. Partial bulkheads or decks used to subdivide a space for utility or artistic treatment shall be of non-combustible materials.

3.1.3.2. Linings, ceilings and partial bulkheads or decks used to screen or to separate adjacent cabin balconies shall be of non-combustible materials.

Cabin balconies on passenger ships constructed before 1 July 2008 shall comply with the requirements of this paragraph by the first survey after 1 July 2008.

3.2. Use of combustible materials

3.2.1. General

3.2.1.1. In passenger ships, "A", "B" or "C" class divisions in accommodation and service spaces and cabin balconies which are faced with combustible materials, facings, mouldings, decorations and veneers shall comply with the provisions of paragraphs 3.2.2 to 3.2.4 and regulation 6. However, traditional wooden benches and wooden linings on bulkheads and ceilings are permitted in saunas and such materials need not be subject to the calculations prescribed in paragraphs 3.2.2 and 3.2.3. However, the provisions of paragraph 3.2.3 need not be applied to cabin balconies.

3.2.1.2. In cargo ships, non-combustible bulkheads, ceilings and linings fitted in accommodation and service spaces may be faced with combustible materials, facings, mouldings, decorations and veneers provided such spaces are bounded by non-combustible bulkheads, ceilings and linings in accordance with the provisions of paragraphs 3.2.2 to 3.2.4 and regulation 6.

3.2.2. Maximum calorific value of combustible materials

Combustible materials used on the surfaces and linings specified in paragraph 3.2.1 shall have a calorific value⁵ not exceeding 45 MJ/m² of the area for the thickness used.

3.2.3. Total volume of combustible materials

Where combustible materials are used in accordance with paragraph 3.2.1, they shall comply with the following requirements:

3.2.3.1. The total volume of combustible facings, mouldings, decorations and veneers in accommodation and service spaces shall not exceed a volume equivalent to 2.5 mm veneer on the combined area of the walls and ceiling linings. Furniture fixed to linings, bulkheads or decks need not be included in the calculation of the total volume of combustible materials; and

3.2.3.2. in the case of ships fitted with an automatic sprinkler system complying with the provisions of the Fire Safety Systems Code, the above volume may include some combustible material used for erection of "C" class divisions.

3.2.4. Low flame-spread characteristics of exposed surfaces

The following surfaces shall have low flame-spread characteristics in accordance with the Fire Test Procedures Code:

3.2.4.1. In passenger ships:

3.2.4.1.1. exposed surfaces in corridors and stairway enclosures and of bulkhead and ceiling linings in accommodation and service spaces (except saunas) and control stations; and

3.2.4.1.2. surfaces and grounds in concealed or inaccessible spaces in accommodation and service spaces and control stations.

⁵ Refer to the recommendations published by the International Organization for Standardization, in particular publication ISO 1716:1973, Determination of calorific potential.

- 3.2.4.1.3. exposed surfaces of cabin balconies, except for natural hard wood decking systems.
- 3.2.4.2. In cargo ships:
 - 3.2.4.2.1. exposed surfaces in corridors and stairway enclosures and of ceilings in accommodation and service spaces (except saunas) and control stations; and
 - 3.2.4.2.2. surfaces and grounds in concealed or inaccessible spaces in accommodation and service spaces and control stations.

3.3. Furniture in stairway enclosures of passenger ships

Furniture in stairway enclosures shall be limited to seating. It shall be fixed, limited to six seats on each deck in each stairway enclosure, be of restricted fire risk determined in accordance with the Fire Test Procedures Code, and shall not restrict the passenger escape route. The Administration may permit additional seating in the main reception area within a stairway enclosure if it is fixed, non-combustible and does not restrict the passenger escape route. Furniture shall not be permitted in passenger and crew corridors forming escape routes in cabin areas. In addition to the above, lockers of non-combustible material, providing storage for non-hazardous safety equipment required by these regulations, may be permitted. Drinking water dispensers and ice cube machines may be permitted in corridors provided they are fixed and do not restrict the width of the escape routes. This applies as well to decorative flower or plant arrangements, statues or other objects of art such as paintings and tapestries in corridors and stairways.

3.4 Furniture and furnishing on cabin balconies of passenger ships

On passenger ships, furniture and furnishing on cabin balconies shall comply with regulation 3.40.1, 3.40.2, 3.40.3, 3.40.6 and 3.40.7 unless such balconies are protected by a fixed pressure water-spraying and fixed fire detection and fire alarm systems complying with regulation 7.10 and 10.6.1.3. Passenger ships constructed before 1 July 2008 shall comply with the requirement of this paragraph by the first survey after 1 July 2008.

Regulation 6 – Smoke generation potential and toxicity

1. Purpose

The purpose of this regulation is to reduce the hazard to life from smoke and toxic products generated during a fire in spaces where persons normally work or live. For this purpose, the quantity of smoke and toxic products released from combustible materials, including surface finishes, during fire shall be limited.

2. Paints, varnishes and other finishes

2.1. Paints, varnishes and other finishes used on exposed interior surfaces shall not be capable of producing excessive quantities of smoke and toxic products, this being determined in accordance with the Fire Test Procedures Code.

2.2. On passenger ships constructed on or after 1 July 2008, paints, varnishes and other finishes used on exposed surfaces of cabin balconies, excluding natural hard wood decking systems, shall not be capable of producing excessive quantities of smoke and toxic products, this being determined in accordance with the Fire Test Procedures Code.

3. Primary deck coverings

3.1. Primary deck coverings, if applied within accommodation and service spaces and control stations, shall be of approved material which will not give rise to smoke or toxic or explosive hazards at elevated temperatures, this being determined in accordance with the Fire Test Procedures Code.

- 3.2. On passenger ships constructed on or after 1 July 2008, primary deck coverings on cabin balconies shall not give rise to smoke, toxic or explosive hazards at elevated temperatures, this being determined in accordance with the Fire Test Procedures Code.

**Notice from the Danish Maritime Authority B –
The Construction and Equipment, etc. of Ships**

Chapter B II-2 C

Construction – Fire protection, fire detection and fire extinction

Regulation 7 – Detection and alarm.....	1
Regulation 8 – Control of smoke spread.....	4
Regulation 9 – Containment of fire.....	5
Regulation 10 – Fire fighting	36
Regulation 11 – Structural integrity.....	50

Part C – Suppression of fire

Regulation 7 – Detection and alarm

1. Purpose

The purpose of this regulation is to detect a fire in the space of origin and to provide for alarm for safe escape and fire-fighting activity. For this purpose, the following functional requirements shall be met:

- 1.1. fixed fire detection and fire alarm system installations shall be suitable for the nature of the space, fire growth potential and potential generation of smoke and gases;
- 1.2. manually operated call points shall be placed effectively to ensure a readily accessible means of notification; and
- 1.3. fire patrols shall provide an effective means of detecting and locating fires and alerting the navigation bridge and fire teams.

2. General requirements

- 2.1. A fixed fire detection and fire alarm system shall be provided in accordance with the provisions of this regulation.
- 2.2. A fixed fire detection and fire alarm system and a sample extraction smoke detection system required in this regulation and other regulations in this part shall be of an approved type and comply with the Fire Safety Systems Code.
- 2.3. Where a fixed fire detection and fire alarm system is required for the protection of spaces other than those specified in paragraph 5.1, at least one detector complying with the Fire Safety Systems Code shall be installed in each such space.
- 2.4. A fixed fire detection and fire alarm system for passenger ships shall be capable of remotely and individually identifying each detector and manually operated call point.

3. Initial and periodical tests

- 3.1. The function of fixed fire detection and fire alarm systems required by the relevant regulations of this chapter shall be tested under varying conditions of ventilation after installation.
- 3.2. The function of fixed fire detection and fire alarm systems shall be periodically tested to the satisfaction of the Administration by means of equipment producing hot air at the appropriate temperature, or smoke or aerosol particles having the appropriate range of density or particle size, or other phenomena associated with incipient fires to which the detector is designed to respond.

4. Protection of machinery spaces

4.1. Installation

A fixed fire detection and fire alarm system shall be installed in:

4.1.1. periodically unattended machinery spaces; and

4.1.2. machinery spaces where:

4.1.2.1. the installation of automatic and remote control systems and equipment has been approved in lieu of continuous manning of the space; and

4.1.2.2. the main propulsion and associated machinery, including the main sources of electrical power, are provided with various degrees of automatic or remote control and are under continuous manned supervision from a control room.

4.2. Design

The fixed fire detection and fire alarm system required in paragraph 4.1.1 shall be so designed and the detectors so positioned as to detect rapidly the onset of fire in any part of those spaces and under any normal conditions of operation of the machinery and variations of ventilation as required by the possible range of ambient temperatures. Except in spaces of restricted height and where their use is specially appropriate, detection systems using only thermal detectors shall not be permitted. The detection system shall initiate audible and visual alarms distinct in both respects from the alarms of any other system not indicating fire, in sufficient places to ensure that the alarms are heard and observed on the navigation bridge and by a responsible engineer officer. When the navigation bridge is unmanned, the alarm shall sound in a place where a responsible member of the crew is on duty.

5. Protection of accommodation and service spaces and control stations

5.1. Smoke detectors in accommodation spaces

Smoke detectors shall be installed in all stairways, corridors and escape routes within accommodation spaces as provided in paragraphs 5.2, 5.3 and 5.4. Consideration shall be given to the installation of special purpose smoke detectors within ventilation ducting.

5.2. Requirements for passenger ships carrying more than 36 passengers

A fixed fire detection and fire alarm system shall be so installed and arranged as to provide smoke detection in service spaces, control stations and accommodation spaces, including corridors, stairways and escape routes within accommodation spaces. Smoke detectors need not be fitted in private bathrooms and galleys. Spaces having little or no fire risk such as voids, public toilets, carbon dioxide rooms and similar spaces need not be fitted with a fixed fire detection and alarm system. Detectors fitted in cabins, when activated, shall also be capable of emitting, or cause to be emitted, an audible alarm within the space where they are located.

5.3. Requirements for passenger ships carrying not more than 36 passengers

There shall be installed throughout each separate zone, whether vertical or horizontal, in all accommodation and service spaces and, where it is considered necessary by the Administration, in control stations, except spaces which afford no substantial fire risk such as void spaces, sanitary spaces, etc., either:

5.3.1. a fixed fire detection and fire alarm system so installed and arranged as to detect the presence of fire in such spaces and providing smoke detection in corridors, stairways and escape routes within accommodation spaces. Detectors fitted in cabins, when activated, shall also be capable of emitting, or cause to be emitted, an audible alarm within the space where they are located; or

5.3.2. an automatic sprinkler, fire detection and fire alarm system of an approved type complying with the relevant requirements of the Fire Safety Systems Code and so installed and arranged as to protect such spaces and, in addition, a fixed fire detection and fire alarm system and so installed and arranged as to provide smoke detection in corridors, stairways and escape routes within accommodation spaces.

5.4. Protection of atriums in passenger ships

The entire main vertical zone containing the atrium shall be protected throughout with a smoke detection system.

5.5. Cargo ships

Accommodation and service spaces and control stations of cargo ships shall be protected by a fixed fire detection and fire alarm system and/or an automatic sprinkler, fire detection and fire alarm system as follows, depending on a protection method adopted in accordance with regulation 9.2.3.1.

5.5.1. Method IC

A fixed fire detection and fire alarm system shall be so installed and arranged as to provide smoke detection in all corridors, stairways and escape routes within accommodation spaces.

5.5.2. Method IIC

An automatic sprinkler, fire detection and fire alarm system of an approved type complying with the relevant requirements of the Fire Safety Systems Code shall be so installed and arranged as to protect accommodation spaces, galleys and other service spaces, except spaces which afford no substantial fire risk such as void spaces, sanitary spaces, etc. In addition, a fixed fire detection and fire alarm system shall be so installed and arranged as to provide smoke detection in all corridors, stairways and escape routes within accommodation spaces.

5.5.3. Method IIIC

A fixed fire detection and fire alarm system shall be so installed and arranged as to detect the presence of fire in all accommodation spaces and service spaces, providing smoke detection in corridors, stairways and escape routes within accommodation spaces, except spaces which afford no substantial fire risk such as void spaces, sanitary spaces, etc.

6. Protection of cargo spaces in passenger ships

A fixed fire detection and fire alarm system or a sample extraction smoke detection system shall be provided in any cargo space which, in the opinion of the Administration, is not accessible, except where it is shown to the satisfaction of the Administration that the ship is engaged on voyages of such short duration that it would be unreasonable to apply this requirement.

7. Manually operated call points

Manually operated call points complying with the Fire Safety Systems Code shall be installed throughout the accommodation spaces, service spaces and control stations. One manually operated call point shall be located at each exit. Manually operated call points shall be readily accessible in the corridors of each deck such that no part of the corridor is more than 20 m from a manually operated call point.

8. Fire patrols in passenger ships

8.1. Fire patrols

For ships carrying more than 36 passengers, an efficient patrol system shall be maintained so that an outbreak of fire may be promptly detected. Each member of the fire patrol shall be trained to be familiar with the arrangements of the ship as well as the location and operation of any equipment he may be called upon to use.

8.2. Inspection hatches

The construction of ceilings and bulkheads shall be such that it will be possible, without impairing the efficiency of the fire protection, for the fire patrols to detect any smoke originating in concealed and inaccessible places, except where in the opinion of the Administration there is no risk of fire originating in such places.

8.3. Two-way portable radiotelephone apparatus

Each member of the fire patrol shall be provided with a two-way portable radiotelephone apparatus.

9. Fire alarm signalling systems in passenger ships¹

9.1. Passenger ships shall at all times when at sea, or in port (except when out of service), be so manned or equipped as to ensure that any initial fire alarm is immediately received by a responsible member of the crew.

9.2. The control panel of fixed fire detection and fire alarm systems shall be designed on the fail-safe principle (e.g., an open detector circuit shall cause an alarm condition).

9.3. Passenger ships carrying more than 36 passengers shall have the fire detection alarms for the systems required by paragraph 5.2 centralized in a continuously manned central control station. In addition, controls for remote closing of the fire doors and shutting down the ventilation fans shall be centralized in the same location. The ventilation fans shall be capable of reactivation by the crew at the continuously manned control station. The control panels in the central control station shall be capable of indicating open or closed positions of fire doors and closed or off status of the detectors, alarms and fans. The control panel shall be continuously powered and shall have an automatic change-over to standby power supply in case of loss of normal power supply. The control panel shall be powered from the main source of electrical power and the emergency source of electrical power defined by regulation II-1/42 unless other arrangements are permitted by the regulations, as applicable.

9.4. A special alarm, operated from the navigation bridge or fire control station, shall be fitted to summon the crew. This alarm may be part of the ship's general alarm system and shall be capable of being sounded independently of the alarm to the passenger spaces.

10. Protection of cabin balconies on passenger ships

A fixed fire detection and alarm system complying with the provisions of the Fire Safety Systems Code shall be installed on cabin balconies of ships to which regulation 5.3.4 applies, when furniture and furnishings on such balconies are not as defined in 3.40.1, 3.40.2, 3.40.3, 3.40.6 and 3.40.7.

Regulation 8 – Control of smoke spread

1. Purpose

The purpose of this regulation is to control the spread of smoke in order to minimize the hazards from smoke. For this purpose, means for controlling smoke in atriums, control stations, machinery spaces and concealed spaces shall be provided.

2. Protection of control stations outside machinery spaces

Practicable measures shall be taken for control stations outside machinery spaces in order to ensure that ventilation, visibility and freedom from smoke are maintained so that, in the event of fire, the machinery and equipment contained therein may be supervised and continue to function effectively. Alternative and separate means of air supply shall be provided and air inlets of the two sources of supply shall be so disposed that the risk of both inlets drawing in smoke

¹ Refer to the Code on Alarms and Indicators adopted by the Organization by resolution A.830(19).

simultaneously is minimized. At the discretion of the Administration, such requirements need not apply to control stations situated on, and opening onto, an open deck or where local closing arrangements would be equally effective. The ventilation system serving safety centres may be derived from the ventilation system serving the navigation bridge, unless located in an adjacent main vertical zone.

3. Release of smoke from machinery spaces

3.1. The provisions of this paragraph shall apply to machinery spaces of category A and, where the Administration considers it desirable, to other machinery spaces.

3.2. Suitable arrangements shall be made to permit the release of smoke, in the event of fire, from the space to be protected, subject to the provisions of regulation 9.5.2.1 The normal ventilation systems may be acceptable for this purpose.

3.3. Means of control shall be provided for permitting the release of smoke and such controls shall be located outside the space concerned so that they will not be cut off in the event of fire in the space they serve.

3.4. In passenger ships, the controls required by paragraph 3.3 shall be situated at one control position or grouped in as few positions as possible to the satisfaction of the Administration. Such positions shall have a safe access from the open deck.

4. Draught stops

Air spaces enclosed behind ceilings, panelling or linings shall be divided by close-fitting draught stops spaced not more than 14 m apart. In the vertical direction, such enclosed air spaces, including those behind linings of stairways, trunks, etc., shall be closed at each deck.

5. Smoke extraction systems in atriums of passenger ships

Atriums shall be equipped with a smoke extraction system. The smoke extraction system shall be activated by the required smoke detection system and be capable of manual control. The fans shall be sized such that the entire volume within the space can be exhausted in 10 min or less.

Regulation 9 – Containment of fire

1. Purpose

The purpose of this regulation is to contain a fire in the space of origin. For this purpose, the following functional requirements shall be met:

1.1. the ship shall be subdivided by thermal and structural boundaries;

1.2. thermal insulation of boundaries shall have due regard to the fire risk of the space and adjacent spaces; and

1.3. the fire integrity of the divisions shall be maintained at openings and penetrations.

2. Thermal and structural boundaries

2.1. Thermal and structural subdivision

Ships of all types shall be subdivided into spaces by thermal and structural divisions having regard to the fire risks of the spaces.

2.2. Passenger ships

2.2.1. Main vertical zones and horizontal zones

2.2.1.1.

2.2.1.1.1. In ships carrying more than 36 passengers, the hull, superstructure and deckhouses shall be subdivided into main vertical zones² by "A-60" class divisions. Steps and recesses shall be kept to a minimum, but where they are necessary

² There shall be at least two such main divisions unless the Danish Maritime Authority deems in each individual case and with reference to the provisions of regulation 1.4.1, including the note, that this will not enhance the fire integrity of the ship.

they shall also be "A-60" class divisions. Where a category (5), (9) or (10) space defined in paragraph 2.2.3.2.2 is on one side or where fuel oil tanks are on both sides of the division the standard may be reduced to "A-0".

- 2.2.1.1.2.** In ships carrying not more than 36 passengers, the hull, superstructure and deckhouses in way of accommodation and service spaces shall be subdivided into main vertical zones³ by "A" class divisions. These divisions shall have insulation values in accordance with tables in paragraph 2.2.4.
 - 2.2.1.2.** As far as practicable, the bulkheads forming the boundaries of the main vertical zones above the bulkhead deck shall be in line with watertight subdivision bulkheads situated immediately below the bulkhead deck. The length and width of main vertical zones may be extended to a maximum of 48 m in order to bring the ends of main vertical zones to coincide with watertight subdivision bulkheads or in order to accommodate a large public space extending for the whole length of the main vertical zone provided that the total area of the main vertical zone is not greater than 1,600 m² on any deck. The length or width of a main vertical zone is the maximum distance between the furthestmost points of the bulkheads bounding it.
 - 2.2.1.3.** Such bulkheads shall extend from deck to deck and to the shell or other boundaries.
 - 2.2.1.4.** Where a main vertical zone is subdivided by horizontal "A" class divisions into horizontal zones for the purpose of providing an appropriate barrier between a zone with sprinklers and a zone without sprinklers, the divisions shall extend between adjacent main vertical zone bulkheads and to the shell or exterior boundaries of the ship and shall be insulated in accordance with the fire insulation and integrity values given in table 9.4.
 - 2.2.1.5.**
 - 2.2.1.5.1.** On ships designed for special purposes, such as automobile or railroad car ferries, where the provision of main vertical zone bulkheads would defeat the purpose for which the ship is intended, equivalent means for controlling and limiting a fire shall be substituted and specifically approved by the Administration. Service spaces and ship stores shall not be located on ro-ro decks unless protected in accordance with the applicable regulations.
 - 2.2.1.5.2.** However, in a ship with special category spaces (*e.g. car deck spaces*), such spaces shall comply with the applicable provisions of regulation 20 and, where such compliance would be inconsistent with other requirements for passenger ships specified in this chapter, the requirements of regulation 20 shall prevail.
- 2.2.2. Bulkheads within a main vertical zone**

³ There shall be at least two such main divisions unless the Danish Maritime Authority deems in each individual case and with reference to the provisions of regulation 1.4.1, including the note, that this will not enhance the fire integrity of the ship.

- 2.2.2.1.** For ships carrying more than 36 passengers, bulkheads which are not required to be "A" class divisions shall be at least "B" class or "C" class divisions as prescribed in the tables in paragraph 2.2.3.
- 2.2.2.2.** For ships carrying not more than 36 passengers, bulkheads within accommodation and service spaces which are not required to be "A" class divisions shall be at least "B" class or "C" class divisions as prescribed in the tables in paragraph 2.2.4. In addition, corridor bulkheads, where not required to be "A" class, shall be "B" class divisions which shall extend from deck to deck except:
 - 2.2.2.2.1.** when continuous "B" class ceilings or linings are fitted on both sides of the bulkhead, the portion of the bulkhead behind the continuous ceiling or lining shall be of material which, in thickness and composition, is acceptable in the construction of "B" class divisions, but which shall be required to meet "B" class integrity standards only in so far as is reasonable and practicable in the opinion of the Administration; and
 - 2.2.2.2.2.** in the case of a ship protected by an automatic sprinkler system complying with the provisions of the Fire Safety Systems Code, the corridor bulkheads may terminate at a ceiling in the corridor provided such bulkheads and ceilings are of "B" class standard in compliance with paragraph 2.2.4. All doors and frames in such bulkheads shall be of non-combustible materials and shall have the same fire integrity as the bulkhead in which they are fitted.
- 2.2.2.3.** Bulkheads required to be "B" class divisions, except corridor bulkheads as prescribed in paragraph 2.2.2.2, shall extend from deck to deck and to the shell or other boundaries. However, where a continuous "B" class ceiling or lining is fitted on both sides of a bulkhead which is at least of the same fire resistance as the adjoining bulkhead, the bulkhead may terminate at the continuous ceiling or lining.
- 2.2.3.** Fire integrity of bulkheads and decks in ships carrying more than 36 passengers.
 - 2.2.3.1.** In addition to complying with the specific provisions for fire integrity of bulkheads and decks of passenger ships, the minimum fire integrity of all bulkheads and decks shall be as prescribed in tables 9.1 and 9.2. Where, due to any particular structural arrangements in the ship, difficulty is experienced in determining from the tables the minimum fire integrity value of any divisions, such values shall be determined to the satisfaction of the Administration.
 - 2.2.3.2.** The following requirements shall govern application of the tables:
 - 2.2.3.2.1.** Table 9.1 shall apply to bulkheads not bounding either main vertical zones or horizontal zones. Table 9.2 shall apply to decks not forming steps in main vertical zones nor bounding horizontal zones.
 - 2.2.3.2.2.** For determining the appropriate fire integrity standards to be applied to boundaries between adjacent spaces, such spaces are classified according to their fire risk as shown in categories (1) to (14) below. Where the contents and use of a

space are such that there is a doubt as to its classification for the purpose of this regulation, or where it is possible to assign two or more classifications to a space, it shall be treated as a space within the relevant category having the most stringent boundary requirements. Smaller, enclosed rooms within a space that have less than 30% communicating openings to that space are considered separate spaces. The fire integrity of the boundary bulkheads and decks of such smaller rooms shall be as prescribed in tables 9.1 and 9.2. The title of each category is intended to be typical rather than restrictive. The number in parentheses preceding each category refers to the applicable column or row in the tables.

(1) Control stations

Spaces containing emergency sources of power and lighting.

Wheelhouse and chartroom.

Spaces containing the ship's radio equipment.

Fire control stations.

Control room for propulsion machinery when located outside the propulsion machinery space.

Spaces containing centralized fire alarm equipment.

Spaces containing centralized emergency public address system stations and equipment.

(2) Stairways

Interior stairways, lifts, totally enclosed emergency escape trunks, and escalators (other than those wholly contained within the machinery spaces) for passengers and crew and enclosures thereto.

In this connection, a stairway which is enclosed at only one level shall be regarded as part of the space from which it is not separated by a fire door.

(3) Corridors

Passenger and crew corridors and lobbies.

(4) Evacuation stations and external escape routes

Survival craft stowage area.

Open deck spaces and enclosed promenades forming lifeboat and liferaft embarkation and lowering stations.

Assembly stations, internal and external.

External stairs and open decks used for escape routes.

The ship's side to the waterline in the lightest seagoing condition, superstructure and deckhouse sides situated below and adjacent to the liferaft and evacuation slide embarkation areas.

(5) Open deck spaces

Open deck spaces and enclosed promenades clear of lifeboat and liferaft embarkation and lowering stations. To be considered in this category, enclosed promenades shall have no significant fire risk, meaning that furnishings shall be restricted to deck furniture. In addition, such spaces shall be naturally ventilated by permanent openings.

Air spaces (the space outside superstructures and deckhouses).

(6) Accommodation spaces of minor fire risk

Cabins containing furniture and furnishings of restricted fire risk.

Offices and dispensaries containing furniture and furnishings of restricted fire risk.

Public spaces containing furniture and furnishings of restricted fire risk and having a deck area of less than 50 m².

(7) Accommodation spaces of moderate fire risk

Spaces as in category (6) above but containing furniture and furnishings of other than restricted fire risk.

Public spaces containing furniture and furnishings of restricted fire risk and having a deck area of 50 m² or more.

Isolated lockers and small store-rooms in accommodation spaces having areas less than 4 m² (in which flammable liquids are not stowed).

Motion picture projection and film stowage rooms. Diet kitchens (containing no open flame).

Cleaning gear lockers (in which flammable liquids are not stowed).

Laboratories (in which flammable liquids are not stowed).

Pharmacies.

Small drying rooms (having a deck area of 4 m² or less).

Specie rooms.

Operating rooms.

(8) Accommodation spaces of greater fire risk

Public spaces containing furniture and furnishings of other than restricted fire risk and having a deck area of 50 m² or more.

Barber shops and beauty parlours.

Saunas.

Sale shops.

(9) Sanitary and similar spaces

Communal sanitary facilities, showers, baths, water closets, etc.

Small laundry rooms.

Indoor swimming pool area.

Isolated pantries containing no cooking appliances in accommodation spaces.

Private sanitary facilities shall be considered a portion of the space in which they are located.

(10) Tanks, voids and auxiliary machinery spaces having little or no fire risk

Water tanks forming part of the ship's structure.

Voids and cofferdams.

Auxiliary machinery spaces which do not contain machinery having a pressure lubrication system and where storage of combustibles is prohibited, such as:

ventilation and air-conditioning rooms; windlass room; steering gear room; stabilizer equipment room; electrical propulsion motor room; rooms containing section switchboards and purely electrical equipment other than oil-filled electrical transformers (above 10 kVA); shaft alleys and pipe tunnels; and spaces for pumps and refrigeration machinery (not handling or using flammable liquids).

Closed trunks serving the spaces listed above.

Other closed trunks such as pipe and cable trunks.

(11) Auxiliary machinery spaces, cargo spaces, cargo and other oil tanks and other similar spaces of moderate fire risk

Cargo oil tanks.

Cargo holds, trunkways and hatchways.

Refrigerated chambers.

Oil fuel tanks (where installed in a separate space with no machinery).

Shaft alleys and pipe tunnels allowing storage of combustibles.

Auxiliary machinery spaces as in category (10) which contain machinery having a pressure lubrication system or where storage of combustibles is permitted.

Oil fuel filling stations.

Spaces containing oil-filled electrical transformers (above 10 kVA).

Spaces containing turbine and reciprocating steam engine driven auxiliary generators and small internal combustion engines of power output up to 110 kW driving generators, sprinkler, drencher or fire pumps, bilge pumps, etc.

Closed trunks serving the spaces listed above.

(12) Machinery spaces and main galleys

Main propulsion machinery rooms (other than electric propulsion motor rooms) and boiler rooms.

Auxiliary machinery spaces other than those in categories (10) and (11) which contain internal combustion machinery or other oil-burning, heating or pumping units.

Main galleys and annexes.

Trunks and casings to the spaces listed above.

(13) Store-rooms, workshops, pantries, etc.

Main pantries not annexed to galleys.

Main laundry.

Large drying rooms (having a deck area of more than 4m²).

Miscellaneous stores.

Mail and baggage rooms.

Garbage rooms.

Workshops (not part of machinery spaces, galleys, etc.).

Lockers and store-rooms having areas greater than 4 m², other than those spaces that have provisions for the storage of flammable liquids.

(14) Other spaces in which flammable liquids are stowed

Paint lockers.

Store-rooms containing flammable liquids (including dyes, medicines, etc.).

Laboratories (in which flammable liquids are stowed).

.3 Where a single value is shown for the fire integrity of a boundary between two spaces, that value shall apply in all cases.

.4 Notwithstanding the provisions of paragraph 2.2.2, there are no special requirements for material or integrity of boundaries where only a dash appears in the tables.

.5 The Administration shall determine in respect of category (5) spaces whether the insulation values in table 9.1 shall apply to ends of deckhouses and superstructures, and whether the insulation values in table 9.2 shall apply to weather decks. In no case shall the requirements of category (5) of tables 9.1 or 9.2 necessitate enclosure of spaces which in the opinion of the Administration need not be enclosed.

Table 9.1 – Bulkheads not bounding either main vertical zones or horizontal zones

Spaces		(1)	(2)	(3)	(4)	(5)	(6)	(7)	(8)	(9)	(10)	(11)	(12)	(13)	(14)
Control stations	(1)	B-0a)	A-0	A-0	A-0	A-0	A-60	A-60	A-60	A-0	A-0	A-60	A-60	A-60	A-60
Stairways	(2)		A-0a)	A-0	A-0	A-0	A-0	A-15	A-15	A-0 ^c	A-0	A-15	A-30	A-15	A-30
Corridors	(3)			B-15	A-60	A-0	B-15	B-15	B-15	B-15	A-0	A-15	A-30	A-0	A-30
Evacuation stations and external escape routes	(4)					A-0	A-60bd)	A-60bd)	A-60bd)	A-0d)	A-0	A-60b)	A-60b)	A-60b)	A-60b)
Open deck spaces	(5)					-	A-0	A-0	A-0	A-0	A-0	A-0	A-0	A-0	A-0
Accommodation spaces of minor fire risk	(6)						B-0	B-0	B-0	C	A-0	A-0	A-30	A-0	A-30
Accommodation spaces of moderate fire risk	(7)							B-0	B-0	C	A-0	A-15	A-60	A-15	A-60
Accommodation spaces of greater fire risk	(8)								B-0	C	A-0	A-30	A-60	A-15	A-60
Sanitary and similar spaces	(9)									C	A-0	A-0	A-0	A-0	A-0
Tanks, voids and auxiliary machinery spaces having little or no fire risk	(10)										A-0a)	A-0	A-0	A-0	A-0
Auxiliary machinery spaces, cargo spaces, cargo and other oil tanks and other similar spaces of moderate fire risk	(11)											A-0a)	A-0	A-0	A-15
Machinery spaces and main galleys	(12)												A-0a)	A-0	A-60
Store-rooms, workshops, pantries, etc.	(13)													A-0a)	A-0
Other spaces in which flammable liquids are stowed	(14)														A-30

Table 9.2 – Decks not forming steps in main vertical zones nor bounding horizontal zones

Space above → Space below ↓		(1)	(2)	(3)	(4)	(5)	(6)	(7)	(8)	(9)	(10)	(11)	(12)	(13)	(14)
Control stations	(1)	A-30	A-30	A-15	A-0	A-0	A-0	A-15	A-30	A-0	A-0	A-0	A-60	A-0	A-60
Stairways	(2)	A-0	A-0	-	A-0	A-0	A-0	A-0	A-0	A-0	A-0	A-0	A-30	A-0	A-30
Corridors	(3)	A-15	A-0	A-0	A-60	A-0	A-0	A-15	A-15	A-0	A-0	A-0	A-30	A-0	A-30
Evacuation stations and external escape routes	(4)	A-0	A-0	A-0	A-0	-	A-0	A-0	A-0	A-0	A-0	A-0	A-0	A-0	A-0
Åbne dæksarealer Open deck spaces	(5)	A-0	A-0	A-0	A-0	-	A-0	A-0	A-0	A-0	A-0	A-0	A-0	A-0	A-0
Accommodation spaces of minor fire risk	(6)	A-60	A-15	A-0	A-60	A-0	A-0	A-0	A-0	A-0	A-0	A-0	A-0	A-0	A-0
Accommodation spaces of moderate fire risk	(7)	A-60	A-15	A-15	A-60	A-0	A-0	A-15	A-15	A-0	A-0	A-0	A-0	A-0	A-0
Accommodation spaces of greater fire risk	(8)	A-60	A-15	A-15	A-60	A-0	A-15	A-15	A-30	A-0	A-0	A-0	A-0	A-0	A-0
Sanitary and similar spaces	(9)	A-0	A-0	A-0	A-0	A-0	A-0	A-0	A-0	A-0	A-0	A-0	A-0	A-0	A-0
Tanks, voids and auxiliary machinery spaces having little or no fire risk	(10)	A-0	A-0	A-0	A-0	A-0	A-0	A-0	A-0	A-0	A-0a)	A-0	A-0	A-0	A-0
Auxiliary machinery spaces, cargo spaces, cargo and other oil tanks and other similar spaces of moderate fire risk	(11)	A-60	A-60	A-60	A-60	A-0	A-0	A-15	A-30	A-0	A-0	A-0a)	A-0	A-0	A-30
Machinery spaces and main galleys	(12)	A-60	A-60	A-60	A-60	A-0	A-60	A-60	A-60	A-0	A-0	A-30	A-30a)	A-0	A-60
Store-rooms, workshops, pantries, etc.	(13)	A-60	A-30	A-15	A-60	A-0	A-15	A-30	A-30	A-0	A-0	A-0	A-0	A-0	A-0
Other spaces in which flammable liquids are stowed	(14)	A-60	A-60	A-60	A-60	A-0	A-30	A-60	A-60	A-0	A-0	A-0	A-0	A-0	A-0

Notes: To be applied to tables 9.1 and 9.2, as appropriate.

a) Where adjacent spaces are in the same numerical category and superscript "a" appears, a bulkhead or deck between such spaces need not be fitted if deemed unnecessary by the Administration. For example, in category (12) a bulkhead need not be required between a galley and its annexed pantries provided the pantry bulkhead and decks maintain the integrity of the galley boundaries. A bulkhead is, however, required between a galley and machinery space even though both spaces are in category (12).

b) The ship's side, to the waterline in the lightest seagoing condition, superstructure and deckhouse sides situated below and adjacent to liferafts and evacuation slides may be reduced to "A-30".

c) Where public toilets are installed completely within the stairway enclosure, the public toilet bulkhead within the stairway enclosure can be of "B" class integrity.

d) Where spaces of categories (6), (7), (8) and (9) are located completely within the outer perimeter of the assembly station, the bulkheads of these spaces are allowed to be of "B-0" class integrity. Control positions for audio, video and light installations may be considered as part of the assembly station.

- Where a (-) occurs in the tables, the subdivision shall be made either of steel or another similar material, but it does not have to be of "A" class integrity.

2.2.3.3 Continuous "B" class ceilings or linings, in association with the relevant decks or bulkheads, may be accepted as contributing, wholly or in part, to the required insulation and integrity of a division.

2.2.3.4 Construction and arrangement of saunas

2.2.3.4.1 The perimeter of the sauna shall be of "A" class boundaries and may include changing rooms, showers and toilets. The sauna shall be insulated to "A- 60" standard against other spaces except those inside of the perimeter and spaces of categories (5), (9) and (10).

2.2.3.4.2 Bathrooms with direct access to saunas may be considered as part of them. In such cases, the door between sauna and the bathroom need not comply with fire safety requirements.

2.2.3.4.3 The traditional wooden lining on the bulkheads and ceiling are permitted in the sauna. The ceiling above the oven shall be lined with a non-combustible plate with an air gap of at least 30 mm. The distance from the hot surfaces to combustible materials shall be at least 500 mm or the combustible materials shall be protected (e.g., non-combustible plate with an air gap of at least 30 mm).

2.2.3.4.4 The traditional wooden benches are permitted to be used in the sauna.

2.2.3.4.5 The sauna door shall open outwards by pushing.

2.2.3.4.6 Electrically heated ovens shall be provided with a timer.

2.2.4 **Fire integrity of bulkheads and decks in ships carrying not more than 36 passengers**

2.2.4.1 In addition to complying with the specific provisions for fire integrity of bulkheads and decks of passenger ships, the minimum fire integrity of bulkheads and decks shall be as prescribed in tables 9.3 and 9.4.

2.2.4.2 The following requirements shall govern application of the tables:

2.2.4.2.1 Tables 9.3 and 9.4 shall apply respectively to the bulkheads and decks separating adjacent spaces

2.2.4.2.2 For determining the appropriate fire integrity standards to be applied to divisions between adjacent spaces, such spaces are classified according to their fire risk as shown in categories (1) to (11) below. Where the contents and use of a space are such that there is a doubt as to its classification for the purpose of this regulation, or where it is possible to assign two or more classifications to a space, it shall be treated as a space within the relevant category having the most stringent boundary requirements. Smaller, enclosed rooms within a space that have less than 30% communicating openings to that space are considered separate spaces. The fire integrity of the boundary bulkheads and decks of such smaller rooms shall be as prescribed in tables 9.3 and 9.4. The title of each category is intended to be typical rather than restrictive. The number in parentheses preceding each category refers to the applicable column or row in the tables.

(1) Control stations

Spaces containing emergency sources of power and lighting.
Wheelhouse and chartroom.

Spaces containing the ship's radio equipment.

Fire control stations.

Control room for propulsion machinery when located outside the machinery space.

Spaces containing centralized fire alarm equipment.

(2) Corridors

Passenger and crew corridors and lobbies.

(3) Accommodation spaces

Spaces as defined in regulation 3.1 excluding corridors.

(4) Stairways

Interior stairways, lifts, totally enclosed emergency escape trunks, and escalators (other than those wholly contained within the machinery spaces) and enclosures thereto. In this connection, a stairway which is enclosed only at one level shall be regarded as part of the space from which it is not separated by a fire door.

(5) Service spaces (low risk)

Lockers and store-rooms not having provisions for the storage of flammable liquids and having areas less than 4m² and drying rooms and laundries.

(6) Machinery spaces of category A

Spaces as defined in regulation 3.31.

(7) Other machinery spaces

Electrical equipment rooms (auto-telephone exchange, air-conditioning duct spaces). Spaces as defined in regulation 3.30 excluding machinery spaces of category A.

(8) Cargo spaces

All spaces used for cargo (including cargo oil tanks) and trunkways and hatchways to such spaces, other than special category spaces.

(9) Service spaces (high risk)

Galleys, pantries containing cooking appliances, paint lockers, lockers and store-rooms having areas of 4 m² or more, spaces for the storage of flammable liquids, saunas and workshops other than those forming part of the machinery spaces.

(10) Open decks

Open deck spaces and enclosed promenades having little or no fire risk. Enclosed promenades shall have no significant fire risk, meaning that furnishing shall be restricted to deck furniture. In addition, such spaces shall be naturally ventilated by permanent openings.

Air spaces (the space outside superstructures and deck houses).

(11) Special category and ro-ro spaces

Spaces as defined in regulations 3.41 and 3.46.

- 2.2.4.2.3** In determining the applicable fire integrity standard of a boundary between two spaces within a main vertical zone or horizontal zone which is not protected by an automatic sprinkler system complying with the provisions of the Fire Safety Systems Code or between such zones neither of which is so protected, the higher of the two values given in the tables shall apply.
- 2.2.4.2.4** In determining the applicable fire integrity standard of a boundary between two spaces within a main vertical zone or horizontal zone which is protected by an automatic sprinkler system complying with the provisions of the Fire Safety Systems Code or between such zones both of which are so protected, the lesser of the two values given in the tables shall apply. Where a zone with sprinklers and a zone without sprinklers meet within accommodation and service spaces, the higher of the two values given in the tables shall apply to the division between the zones.
- 2.2.4.3** Continuous "B" class ceilings or linings, in association with the relevant decks or bulkheads, may be accepted as contributing, wholly or in part, to the required insulation and integrity of a division.
- 2.2.4.4** External boundaries which are required in regulation 11.2 to be of steel or other equivalent material may be pierced for the fitting of windows and sidescuttles provided that there is no requirement for such boundaries of passenger ships to have "A" class integrity. Similarly, in such boundaries which are not required to have "A" class integrity, doors may be constructed of materials which are to the satisfaction of the Administration.
- 2.2.4.5** Saunas shall comply with paragraph 2.2.3.4.

Table 9.3 – Fire integrity of bulkheads separating adjacent spaces

Spaces		(1)	(2)	(3)	(4)	(5)	(6)	(7)	(8)	(9)	(10)	(11)
Control stations	(1)	A-0 ^c	A-0	A-60	A-0	A-15	A-60	A-15	A-60	A-60	*	A-60
Corridors	(2)		Ce)	B-0e)	A-0a)	B-0e)	A-60	A-0	A-0	A-15 A-0 ^d	*	A-15
Accommodation spaces	(3)			Ce)	A-0a)	B-0e)	A-60	A-0	A-0	A-15 A-0 ^d	*	A-30 A-0 ^d
Stairways	(4)				A-0a) B-0e)	A-0a) B-0e)	A-60	A-0	A-0	A-15 A-0 ^d	*	A-15
Service spaces (low risk)	(5)					Ce)	A-60	A-0	A-0	A-0	*	A-0
A Machinery spaces of category A	(6)						*	A-0	A-0	A-60	*	A-60
Other machinery spaces	(7)							A-0 ^b)	A-0	A-0	*	A-0
Cargo spaces	(8)								*	A-0	*	A-0
Service spaces (high risk)	(9)									A-0 ^b)	*	A-30
Open decks	(10)											A-0
Special category and ro-ro spaces	(11)											A-0

Table 9.4 – Fire integrity of decks separating adjacent spaces

Space above → Space below ↓		(1)	(2)	(3)	(4)	(5)	(6)	(7)	(8)	(9)	(10)	(11)
Control stations	(1)	A-0	A-0	A-0	A-0	A-0	A-60	A-0	A-0	A-0	*	A-30
Corridors	(2)	A-0	*	*	A-0	*	A-60	A-0	A-0	A-0	*	A-0
Accommodation spaces	(3)	A-60	A-0	*	A-0	*	A-60	A-0	A-0	A-0	*	A-30 A-0 ^d
Stairways	(4)	A-0	A-0	A-0	*	A-0	A-60	A-0	A-0	A-0	*	A-0
Service spaces (low risk)	(5)	A-15	A-0	A-0	A-0	*	A-60	A-0	A-0	A-0	*	A-0
Machinery spaces of category A	(6)	A-60	A-60	A-60	A-60	A-60	*	A-60 ^f)	A-30	A-60	*	A-60
Other machinery spaces	(7)	A-15	A-0	A-0	A-0	A-0	A-0	*	A-0	A-0	*	A-0
Cargo spaces	(8)	A-60	A-0	A-0	A-0	A-0	A-0	A-0	*	A-0	*	A-0
Service spaces (high risk)	(9)	A-60	A-30 A-0 ^d	A-30 A-0 ^d	A-30 A-0 ^d	A-0	A-60	A-0	A-0	A-0	*	A-30
Open decks	(10)	*	*	*	*	*	*	*	*	*	–	A-0
Special category and ro-ro spaces	(11)	A-60	A-15	A-30 A-0 ^d	A-15	A-0	A-30	A-0	A-0	A-30	A-0	A-0

Notes: To be applied to both tables 9.3 and 9.4 as appropriate.

a) For clarification as to which applies, see paragraphs 2.2.2 and 2.2.5.

b) Where spaces are of the same numerical category and superscript "b" appears, a bulkhead or deck of the rating shown in the tables is only required when the adjacent spaces are for a different purpose (e.g., in category (9)). A galley next to a galley does not require a bulkhead, but a galley next to a paint room requires an "A-0" bulkhead.

c) Bulkheads separating the wheelhouse and chartroom from each other may have a "B-0" rating. No fire rating is required for those partitions separating the navigation bridge and the safety centre when the latter is within the navigation bridge.

d) See paragraphs 2.2.4.2.3 and 2.2.4.2.4.

e) For the application of paragraph 2.2.1.1.2, "B-0" and "C", where appearing in table 9.3, shall be read as "A-0".

f) Fire insulation need not be fitted if the machinery space in category (7), in the opinion of the Administration, has little or no fire risk.

* Where an asterisk appears in the tables, the division is required to be of steel or other equivalent material, but is not required to be of "A" class standard. However, where a deck, except in a category (10) space, is penetrated for the passage of electric cables, pipes and vent ducts, such penetrations shall be made tight to prevent the passage of flame and smoke. Divisions between control stations (emergency generators) and open decks may have air intake openings without means for closure, unless a fixed gas fire-extinguishing system is fitted.

For the application of paragraph 2.2.1.1.2, an asterisk, where appearing in table 9.4, except for categories (8) and (10), shall be read as "A-0".

2.2.5 Protection of stairways and lifts in accommodation area

2.2.5.1 Stairways shall be within enclosures formed of "A" class divisions, with positive means of closure at all openings, except that:

2.2.5.1.1 a stairway connecting only two decks need not be enclosed, provided the integrity of the deck is maintained by proper bulkheads or self-closing doors in one 'tween-deck space. When a stairway is closed in one 'tween-deck space, the stairway enclosure shall be protected in accordance with the tables for decks in paragraphs 2.2.3 or 2.2.4; and

2.2.5.1.2 stairways may be fitted in the open in a public space, provided they lie wholly within the public space.

2.2.5.2 Lift trunks shall be so fitted as to prevent the passage of smoke and flame from one 'tween-deck to another and shall be provided with means of closing so as to permit the control of draught and smoke. Machinery for lifts located within stairway enclosures shall be arranged in a separate room, surrounded by steel boundaries, except that small passages for lift cables are permitted. Lifts which open into spaces other than corridors, public spaces, special category spaces, stairways and external areas shall not open into stairways included in the means of escape.

2.2.6 Arrangement of cabin balconies

On passenger ships constructed on or after 1 July 2008, non-load bearing material partial bulkheads which separate adjacent cabin balconies shall be capable of being opened by the crew from each side for the purpose of fighting fires.

2.2.7 Protection of atriums

2.2.7.1 Atriums shall be within enclosures formed of "A" class divisions having a fire rating determined in accordance with tables 9.2 and 9.4, as applicable.

2.2.7.2 Decks separating spaces within atriums shall have a fire rating determined in accordance with tables 9.2 and 9.4, as applicable.

2.3 Cargo ships except tankers

2.3.1 Methods of protection in accommodation area

2.3.1.1 One of the following methods of protection shall be adopted in accommodation and service spaces and control stations:

2.3.1.1.1 Method IC – The construction of internal divisional bulkheads of non-combustible "B" or "C" class divisions generally without the installation of an automatic sprinkler, fire detection and fire alarm system in the accommodation and service spaces, except as required by regulation 7.5.5.1; or

2.3.1.1.2 Method IIC – The fitting of an automatic sprinkler, fire detection and fire alarm system as required by regulation 7.5.5.2 for the detection and extinction of fire in all spaces in which fire might be expected to originate, generally with no restriction on the type of internal divisional bulkheads; or

2.3.1.1.3 Method IIIC – The fitting of a fixed fire detection and fire alarm system as required by regulation 7.5.5.3 in spaces in which a fire might be expected to originate, generally with no restriction on the type of internal divisional bulkheads, except that in no case shall the area of any accommodation space or spaces bounded by an "A" or "B" class division exceed 50 m². However, consideration may be given by the Administration to increasing this area for public spaces.

2.3.1.2 The requirements for the use of non-combustible materials in the construction and insulation of boundary bulkheads of machinery spaces, control stations, service spaces, etc., and the protection of the above stairway enclosures and corridors will be common to all three methods outlined in paragraph 2.3.1.1.

2.3.1.3 *On cargo ships with a gross tonnage below 150, the Danish Maritime Authority may allow exemptions from the provisions of this regulation considering the use of other suitable materials when conditions, in consideration of the special circumstances of each individual ship, allow for this.*

However, staircases as well as boundaries to engine spaces, accommodation and to spaces for the storage of combustible liquids shall be made of steel or another equivalent material.

2.3.2 Bulkheads within accommodation area

2.3.2.1 Bulkheads required to be "B" class divisions shall extend from deck to deck and to the shell or other boundaries. However, where a continuous "B" class ceiling or lining is fitted on both sides of the bulkhead, the bulkhead may terminate at the continuous ceiling or lining.

2.3.2.2 Method IC – Bulkheads not required by this or other regulations for cargo ships to be "A" or "B" class divisions shall be of at least "C" class construction.

2.3.2.3 Method IIC – There shall be no restriction on the construction of bulkheads not required by this or other regulations for cargo ships to be "A" or "B" class divisions except in individual cases where "C" class bulkheads are required in accordance with table 9.5.

2.3.2.4 Method IIIC – There shall be no restriction on the construction of bulkheads not required for cargo ships to be "A" or "B" class divisions except that the area of any accommodation space or spaces bounded

by a continuous "A" or "B" class division shall in no case exceed 50 m², except in individual cases where "C" class bulkheads are required in accordance with table 9.5. However, consideration may be given by the Administration to increasing this area for public spaces.

2.3.3 Fire integrity of bulkheads and decks

2.3.3.1 In addition to complying with the specific provisions for fire integrity of bulkheads and decks of cargo ships, the minimum fire integrity of bulkheads and decks shall be as prescribed in tables 9.5 and 9.6.

2.3.3.2 The following requirements shall govern application of the tables:

2.3.3.2.1 Tables 9.5 and 9.6 shall apply respectively to the bulkheads and decks separating adjacent spaces.

2.3.3.2.2 For determining the appropriate fire integrity standards to be applied to divisions between adjacent spaces, such spaces are classified according to their fire risk as shown in categories (1) to (11) below. Where the contents and use of a space are such that there is a doubt as to its classification for the purpose of this regulation, or where it is possible to assign two or more classifications to a space, it shall be treated as a space within the relevant category having the most stringent boundary requirements. Smaller, enclosed rooms within a space that have less than 30% communicating openings to that space are considered separate spaces. The fire integrity of the boundary bulkheads and decks of such smaller rooms shall be as prescribed in tables 9.5 and 9.6. The title of each category is intended to be typical rather than restrictive. The number in parentheses preceding each category refers to the applicable column or row in the tables.

(1) Control stations

Spaces containing emergency sources of power and lighting.
Wheelhouse and chartroom.

Spaces containing the ship's radio equipment.

Fire control stations.

Control room for propulsion machinery when located outside the machinery space.

Spaces containing centralized fire alarm equipment.

(2) Corridors

Corridors and lobbies.

(3) Accommodation spaces

Spaces as defined in regulation 3.1, excluding corridors.

(4) Stairways

Interior stairway, lifts, totally enclosed emergency escape trunks, and escalators (other than those wholly contained within the machinery spaces) and enclosures thereto.

In this connection, a stairway which is enclosed only at one level shall be regarded as part of the space from which it is not separated by a fire door.

(5) Service spaces (low risk)

Lockers and store-rooms not having provisions for the storage of flammable liquids and having areas less than 4 m² and drying rooms and laundries.

(6) Machinery spaces of category A

Spaces as defined in regulation 3.31.

(7) Other machinery spaces

Electrical equipment rooms (auto-telephone exchange, air-conditioning duct spaces).

Spaces as defined in regulation 3.30, excluding machinery spaces of category A.

(8) Cargo spaces

All spaces used for cargo (including cargo oil tanks) and trunkways and hatchways to such spaces.

(9) Service spaces (high risk)

Galleys, pantries containing cooking appliances, saunas, paint lockers and store-rooms having areas of 4 m² or more, spaces for the storage of flammable liquids, and workshops other than those forming part of the machinery spaces.

(10) Open decks

Open deck spaces and enclosed promenades having little or no fire risk. To be considered in this category, enclosed promenades shall have no significant fire risk, meaning that furnishings shall be restricted to deck furniture. In addition, such spaces shall be naturally ventilated by permanent openings.

Air spaces (the space outside superstructures and deckhouses).

(11) Ro-ro and vehicle spaces

Ro-ro spaces as defined in regulation 3.41.

Vehicle spaces as defined in regulation 3.49.

Table 9.5 – Fire integrity of bulkheads separating adjacent spaces

Spaces	(1)	(2)	(3)	(4)	(5)	(6)	(7)	(8)	(9)	(10)	(11)	
Control stations	(1)	A-0c)	A-0	A-60	A-0	A-15	A-60	A-15	A-60	A-60	*	A-60
Corridors	(2)		C	B-0	B-0 A-0c)	B-0	A-60	A-0	A-0	A-0	*	A-30
Accommodation spaces	(3)			C-a,b)	B-0 A-0c)	B-0	A-60	A-0	A-0	A-0	*	A-30
Stairways	(4)				B-0 A-0c)	B-0 A-0c)	A-60	A-0	A-0	A-0	*	A-30
Service spaces (low risk)	(5)					C	A-60	A-0	A-0	A-0	*	A-0
Machinery spaces of category A	(6)						*	A-0	A-0g)	A-60	*	A-60f)
Other machinery spaces	(7)							A-0d)	A-0	A-0	*	A-0
Cargo spaces	(8)								*	A-0	*	A-0
Service spaces (high risk)	(9)									A-0d)	*	A-30

Open decks	(10)										-	A-0
Special category and ro-ro spaces	(11)											*h)

Table 9.6 – Fire integrity of decks separating adjacent spaces

Space above → Space below ↓		(1)	(2)	(3)	(4)	(5)	(6)	(7)	(8)	(9)	(10)	(11)
Control stations	(1)	A-0	A-0	A-0	A-0	A-0	A-60	A-0	A-0	A-0	*	A-60
Corridors	(2)	A-0	*	*	A-0	*	A-60	A-0	A-0	A-0	*	A-30
Accommodation spaces	(3)	A-60	A-0	*	A-0	*	A-60	A-0	A-0	A-0	*	A-30
Stairways	(4)	A-0	A-0	A-0	*	A-0	A-60	A-0	A-0	A-0	*	A-30
Service spaces (low risk)	(5)	A-15	A-0	A-0	A-0	*	A-60	A-0	A-0	A-0	*	A-0
Machinery spaces of category A	(6)	A-60	A-60	A-60	A-60	A-60	*	A-60 ⁱ⁾	A-30	A-60	*	A-60
Other machinery spaces	7)	A-15	A-0	A-0	A-0	A-0	A-0	*	A-0	A-0	*	A-0
Cargo spaces	(8)	A-60	A-0	A-0	A-0	A-0	A-0	A-0	*	A-0	*	A-0
Service spaces (high risk)	(9)	A-60	A-0	A-0	A-0	A-0	A-60	A-0	A-0	A-0 ^{d)}	*	A-30
Open decks	(10)	*	*	*	*	*	*	*	*	*	-	*
Special category and ro-ro spaces	(11)	A-60	A-30	A-30	A-30	A-0	A-60	A-0	A-0	A-30	*	*h)

Notes: To be applied to tables 9.5 and 9.6, as appropriate.

- a) No special requirements are imposed upon bulkheads in methods IIC and IIIC fire protection.
- b) In case of method IIIC, "B" class bulkheads of "B-0" rating shall be provided between spaces or groups of spaces of 50 m² and over in area.
- c) For clarification as to which applies, see paragraphs 2.3.2 and 2.3.4.
- d) Where spaces are of the same numerical category and superscript "d" appears, a bulkhead or deck of the rating shown in the tables is only required when the adjacent spaces are for a different purpose (e.g., in category (9)). A galley next to a galley does not require a bulkhead, but a galley next to a paint room requires an "A-0" bulkhead.
- e) Bulkheads separating the wheelhouse, chartroom and radio room from each other may have a "B-0" rating.
- f) An "A-0" rating may be used if no dangerous goods are intended to be carried or if such goods are stowed not less than 3 m horizontally from such a bulkhead.
- g) For cargo spaces in which dangerous goods are intended to be carried, regulation 19.3.8 applies.
- h) Bulkheads and decks separating ro-ro spaces shall be capable of being closed reasonably gastight and such divisions shall have "A" class integrity in so far as reasonable and practicable, if in the opinion of the Administration it has little or no fire risk.
- i) Fire insulation need not be fitted in the machinery space in category (7) if, in the opinion of the Administration, it has little or no fire risk.

* Where an asterisk appears in the tables, the division is required to be of steel or other equivalent material but is not required to be of "A" class standard. However, where a deck, except an open deck, is penetrated for the passage of electric cables, pipes and vent ducts, such penetrations shall be made tight to prevent the passage of flame and smoke.

Divisions between control stations (emergency generators) and open decks may have air intake openings without means for closure, unless a fixed gas fire-extinguishing system is fitted.

2.3.3.3 Continuous "B" class ceilings or linings, in association with the relevant decks or bulkheads, may be accepted as contributing, wholly or in part, to the required insulation and integrity of a division.

2.3.3.4 External boundaries which are required in regulation 11.2 to be of steel or other equivalent material may be pierced for the fitting of windows and sidescuttles provided that there is no requirement for such boundaries of cargo ships to have "A" class integrity. Similarly, in such boundaries which are not required to have "A" class integrity, doors may be constructed of materials which are to the satisfaction of the Administration.

2.3.3.5 Saunas shall comply with paragraph 2.2.3.4.

2.3.4 Protection of stairways and lift trunks in accommodation spaces, service spaces and control stations

2.3.4.1 Stairways which penetrate only a single deck shall be protected, at a minimum, at one level by at least "B-0" class divisions and self-closing doors. Lifts which penetrate only a single deck shall be surrounded by "A-0" class divisions with steel doors at both levels. Stairways and lift trunks which penetrate more than a single deck shall be surrounded by at least "A-0" class divisions and be protected by self-closing doors at all levels.

2.3.4.2 On ships having accommodation for 12 persons or less, where stairways penetrate more than a single deck and where there are at least two escape routes direct to the open deck at every accommodation level, the "A-0" requirements of paragraph 2.3.4.1 may be reduced to "B-0".

2.4 Tankers

2.4.1 Application

For tankers, only method IC as defined in paragraph 2.3.1.1 shall be used.

2.4.2 Fire integrity of bulkheads and decks

2.4.2.1 In lieu of paragraph 2.3 and in addition to complying with the specific provisions for fire integrity of bulkheads and decks of tankers, the minimum fire integrity of bulkheads and decks shall be as prescribed in tables 9.7 and 9.8.

2.4.2.2 The following requirements shall govern application of the tables:

2.4.2.2.1 Tables 9.7 and 9.8 shall apply respectively to the bulkhead and decks separating adjacent spaces

2.4.2.2.2 For determining the appropriate fire integrity standards to be applied to divisions between adjacent spaces, such spaces are classified according to their fire risk as shown in categories (1) to (11) below. Where the contents and use of a space are such that there is a doubt as to its classification for the purpose of this or where it is possible to assign two or more classifications to a space, it shall be treated as a space within the relevant category having the most stringent boundary requirements. Smaller, enclosed areas within a space that have less than 30% communicating openings to that space are

considered separate areas. The fire integrity of the boundary bulkheads and decks of such smaller spaces shall be as prescribed in tables 9.7 and 9.8. The title of each category is intended to be typical rather than restrictive. The number in parentheses preceding each category refers to the applicable column or row in the tables.

(1) Control stations

Spaces containing emergency sources of power and lighting.

Wheelhouse and chartroom.

Spaces containing the ship's radio equipment.

Fire control stations.

Control room for propulsion machinery when located outside the machinery space.

Spaces containing centralized fire alarm equipment.

(2) Corridors

Corridors and lobbies.

(3) Accommodation spaces

Spaces as defined in regulation 3.1, excluding corridors.

(4) Stairways

Interior stairways, lifts, totally enclosed emergency escape trunks, and escalators (other than those wholly contained within the machinery spaces) and enclosures thereto. In this connection, a stairway which is enclosed only at one level shall be regarded as part of the space from which it is not separated by a fire door.

(5) Service spaces (low risk)

Lockers and store-rooms not having provisions for the storage of flammable liquids and having areas less than 4m² and drying rooms and laundries.

(6) Machinery spaces of category A

Spaces as defined in regulation 3.31.

(7) Other machinery spaces

Electrical equipment rooms (auto-telephone exchange and air-conditioning duct spaces).

Spaces as defined in regulation 3.30, excluding machinery spaces of category A.

(8) Cargo pump-rooms

Spaces containing cargo pumps and entrances and trunks to such spaces.

(9) Service spaces (high risk)

Galleys, pantries containing cooking appliances, saunas, paint lockers and store-rooms having areas of 4 m² or more, spaces for the storage of flammable liquids and workshops other than those forming part of the machinery spaces.

(10) Open decks

Open deck spaces and enclosed promenades having little or no fire risk. To be considered in this category, enclosed promenades shall have no significant fire risk, meaning that

furnishings shall be restricted to deck furniture. In addition, such spaces shall be naturally ventilated by permanent openings.

Air spaces (the space outside superstructures and deckhouses).

- 2.4.2.3** Continuous "B" class ceilings or linings, in association with the relevant decks or bulkheads, may be accepted as contributing, wholly or in part, to the required insulation and integrity of a division.
- 2.4.2.4** External boundaries which are required in regulation 11.2 to be of steel or other equivalent material may be pierced for the fitting of windows and sidescuttles provided that there is no requirement for such boundaries of tankers to have "A" class integrity. Similarly, in such boundaries which are not required to have "A" class integrity, doors may be constructed of materials which are to the satisfaction of the Administration.
- 2.4.2.5** Exterior boundaries of superstructures and deckhouses enclosing accommodation and including any overhanging decks which support such accommodation shall be constructed of steel and insulated to "A-60" standard for the whole of the portions which face the cargo area and on the outward sides for a distance of 3 m from the end boundary facing the cargo area. The distance of 3 m shall be measured horizontally and parallel to the middle line of the ship from the boundary which faces the cargo area at each deck level. In the case of the sides of those superstructures and deckhouses, such insulation shall be carried up to the underside of the deck of the navigation bridge.
- 2.4.2.6** Skylights to cargo pump-rooms shall be of steel, shall not contain any glass and shall be capable of being closed from outside the pump-room.
- 2.4.2.7** Construction and arrangement of saunas shall comply with paragraph 2.2.3.4

Table 9.7 – Fire integrity of bulkheads separating adjacent spaces

Spaces	(1)	(2)	(3)	(4)	(5)	(6)	(7)	(8)	(9)	(10)	
Control stations	(1)	A-0 ^(c)	A-0	A-60	A-0	A-15	A-60	A-15	A-60	A-60	*
Corridors	(2)		C	B-0	B-0 A-0a)	B-0	A-60	A-0	A-60	A-0	*
Accommodation spaces	(3)			C	B-0 A-0a)	B-0	A-60	A-0	A-60	A-0	*
Stairways	(4)				B-0 A-0a)	B-0 A-0a)	A-60	A-0	A-60	A-0	*
Service spaces (low risk)	(5)					C	A-60	A-0	A-60	A-0	*
Machinery spaces of category A	(6)						*	A-0	A-0 ^(d)	A-60	*
Other machinery spaces	(7)							A-0 ^(b)	A-0	A-0	*
Cargo pump-room	(8)								*	A-60	*
Service spaces (high risk)	(9)									A-0 ^(b)	*
Open decks	(10)										—

Table 9.8 – Fire integrity of decks separating adjacent spaces

Space above → Space below ↓		(1)	(2)	(3)	(4)	(5)	(6)	(7)	(8)	(9)	(10)
Control stations	(1)	A-0	A-0	A-0	A-0	A-0	A-60	A-0	-	A-0	*
Corridors	(2)	A-0	*	*	A-0	*	A-60	A-0	-	A-0	*
Accommodation spaces	(3)	A-60	A-0	*	A-0	*	A-60	A-0	-	A-0	*
Stairways	(4)	A-0	A-0	A-0	*	A-0	A-60	A-0	-	A-0	*
Service spaces (low risk)	(5)	A-15	A-0	A-0	A-0	*	A-60	A-0	-	A-0	*
Machinery spaces of category A	(6)	A-60	A-60	A-60	A-60	A-60	*	A-60e)	A-0	A-60	*
Other machinery spaces	(7)	A-15	A-0	A-0	A-0	A-0	A-0	*	A-0	A-0	*
Cargo pump-room	(8)	-	-	-	-	-	A-0d)	A-0	*	-	*
Service spaces (high risk)	(9)	A-60	A-0	A-0	A-0	A-0	A-60	A-0	-	A-0b)	*
Open decks	(10)	*	*	*	*	*	*	*	*	*	-

Notes:, To be applied to tables 9.7 and 9.8 as appropriate.

a) For clarification as to which applies, see paragraphs 2.3.2 and 2.3.4.

b) Where spaces are of the same numerical category and superscript "b" appears, a bulkhead or deck of the rating shown in the tables is only required when the adjacent spaces are for a different purpose (e.g., in category (9)). A galley next to a galley does not require a bulkhead but a galley next to a paint room requires an "A-0" bulkhead.

c) Bulkheads separating the wheelhouse, chartroom and radio room from each other may have a "B-0" rating.

d) Bulkheads and decks between cargo pump-rooms and machinery spaces of category A may be penetrated by cargo pump shaft glands and similar gland penetrations, provided that gastight seals with efficient lubrication or other means of ensuring the permanence of the gas seal are fitted in way of the bulkheads or deck.

e) Fire insulation need not be fitted in the machinery space in category (7) if, in the opinion of the Administration, it has little or no fire risk.

* Where an asterisk appears in the table, the division is required to be of steel or other equivalent material, but is not required to be of "A" class standard. However, where a deck, except an open deck, is penetrated for the passage of electric cables, pipes and vent ducts, such penetrations shall be made tight to prevent the passage of flame and smoke. Divisions between control stations (emergency generators) and open decks may have air intake openings without means for closure, unless a fixed gas fire-extinguishing system is fitted.

3 Penetrations in fire-resisting divisions and prevention of heat transmission

3.1 Where "A" class divisions are penetrated, such penetrations shall be tested in accordance with the Fire Test Procedures Code, subject to the provisions of paragraph 4.1.1.5. In the case of ventilation ducts, paragraphs 7.1.2 and 7.3.1 apply. However, where a pipe penetration is made of steel or equivalent material having a thickness of 3 mm or greater and a length of not less than 900 mm (preferably 450 mm on each side of the division), and there are no openings, testing is not required. Such penetrations shall be suitably insulated by extension of the insulation at the same level of the division.

3.2 Where "B" class divisions are penetrated for the passage of electric cables, pipes, trunks, ducts, etc., or for the fitting of ventilation terminals, lighting fixtures and similar devices, arrangements shall be made to ensure that the fire resistance is not

impaired, subject to the provisions of paragraph 7.3.2. Pipes other than steel or copper that penetrate "B" class divisions shall be protected by either:

- 3.2.1** a fire-tested penetration device suitable for the fire resistance of the division pierced and the type of pipe used; or
 - 3.2.2** a steel sleeve, having a thickness of not less than 1.8 mm and a length of not less than 900 mm for pipe diameters of 150 mm or more and not less than 600 mm for pipe diameters of less than 150 mm (preferably equally divided to each side of the division). The pipe shall be connected to the ends of the sleeve by flanges or couplings; or the clearance between the sleeve and the pipe shall not exceed 2.5 mm; or any clearance between pipe and sleeve shall be made tight by means of non-combustible or other suitable material.
- 3.3** Uninsulated metallic pipes penetrating "A" or "B" class divisions shall be of materials having a melting temperature which exceeds 950°C for "A-0" and 850°C for "B-0" class divisions.
 - 3.4** In approving structural fire protection details, the Administration shall have regard to the risk of heat transmission at intersections and terminal points of required thermal barriers. The insulation of a deck or bulkhead shall be carried past the penetration, intersection or terminal point for a distance of at least 450 mm in the case of steel and aluminium structures. If a space is divided with a deck or a bulkhead of "A" class standard having insulation of different values, the insulation with the higher value shall continue on the deck or bulkhead with the insulation of the lesser value for a distance of at least 450 mm.

4 Protection of openings in fire-resisting divisions

4.1 Openings in bulkheads and decks in passenger ships

4.1.1 Openings in "A" class divisions

- 4.1.1.1** Except for hatches between cargo, special category, store, and baggage spaces, and between such spaces and the weather decks, openings shall be provided with permanently attached means of closing which shall be at least as effective for resisting fires as the divisions in which they are fitted.
- 4.1.1.2** The construction of doors and door frames in "A" class divisions, with the means of securing them when closed, shall provide resistance to fire as well as to the passage of smoke and flame equivalent to that of the bulkheads in which the doors are situated, this being determined in accordance with the Fire Test Procedures Code. Doors approved without the sill being part of the frame, which are installed on or after 1 July 2010, shall be installed such that the gap under the door does not exceed 12 mm. A non-combustible sill shall be installed under the door such that floor coverings do not extend beneath the closed door.
- 4.1.1.3** It shall be possible for each door to be opened and closed from each side of the bulkhead by one person only.
- 4.1.1.4** Fire doors in main vertical zone bulkheads, galley boundaries and stairway enclosures other than power-operated watertight doors and those which are normally locked shall satisfy the following requirements:

- 4.1.1.4.1** the doors shall be self-closing and be capable of closing with an angle of inclination of up to 3.5° opposing closure;
- 4.1.1.4.2** the approximate time of closure for hinged fire doors shall be no more than 40 s and no less than 10 s from the beginning of their movement with the ship in upright position. The approximate uniform rate of closure for sliding doors shall be of no more than 0.2 m/s and no less than 0.1 m/s with the ship in upright position;
- 4.1.1.4.3** the doors shall be capable of remote release from the continuously manned central control station, either simultaneously or in groups, and shall be capable of release also individually from a position at both sides of the door. Release switches shall have an on-off function to prevent automatic resetting of the system;
- 4.1.1.4.4** hold-back hooks not subject to central control station release are prohibited;
- 4.1.1.4.5** a door closed remotely from the central control station shall be capable of being re-opened from both sides of the door by local control. After such local opening, the door shall automatically close again;
- 4.1.1.4.6** indication shall be provided at the fire door indicator panel in the continuously manned central control station whether each door is closed;
- 4.1.1.4.7** the release mechanism shall be so designed that the door will automatically close in the event of disruption of the control system or central power supply;
- 4.1.1.4.8** local power accumulators for power-operated doors shall be provided in the immediate vicinity of the doors to enable the doors to be operated at least ten times (fully opened and closed) after disruption of the control system or central power supply using the local controls;
- 4.1.1.4.9** disruption of the control system or central power supply at one door shall not impair the safe functioning of the other doors;
- 4.1.1.4.10** remote-released sliding or power-operated doors shall be equipped with an alarm that sounds at least 5 s but no more than 10 s, after the door is released from the central control station and before the door begins to move and continues sounding until the door is completely closed;
- 4.1.1.4.11** a door designed to re-open upon contacting an object in its path shall reopen not more than 1 m from the point of contact;
- 4.1.1.4.12** double-leaf doors equipped with a latch necessary for their fire integrity shall have a latch that is automatically activated by the operation of the doors when released by the system;

- 4.1.1.4.13** doors giving direct access to special category spaces which are power-operated and automatically closed need not be equipped with the alarms and remote-release mechanisms required in paragraphs 4.1.1.4.3 and 4.1.1.4.10;
- 4.1.1.4.14** the components of the local control system shall be accessible for maintenance and adjusting;
- 4.1.1.4.15** power-operated doors shall be provided with a control system of an approved type which shall be able to operate in case of fire and be in accordance with the Fire Test Procedures Code. This system shall satisfy the following requirements:
 - 4.1.1.4.15.1** the control system shall be able to operate the door at the temperature of at least 200°C for at least 60 min, served by the power supply;
 - 4.1.1.4.15.2** the power supply for all other doors not subject to fire shall not be impaired; and
 - 4.1.1.4.15.3** at temperatures exceeding 200°C, the control system shall be automatically isolated from the power supply and shall be capable of keeping the door closed up to at least 945°C.
- 4.1.1.5** In ships carrying not more than 36 passengers, where a space is protected by an automatic sprinkler fire detection and fire alarm system complying with the provisions of the Fire Safety Systems Code or fitted with a continuous "B" class ceiling, openings in decks not forming steps in main vertical zones nor bounding horizontal zones shall be closed reasonably tight and such decks shall meet the "A" class integrity requirements in so far as is reasonable and practicable in the opinion of the Administration.
- 4.1.1.6** The requirements for "A" class integrity of the outer boundaries of a ship shall not apply to glass partitions, windows and sidescuttles, provided that there is no requirement for such boundaries to have "A" class integrity in paragraph 4.1.3.3. The requirements for "A" class integrity of the outer boundaries of the ship shall not apply to exterior doors, except for those in superstructures and deckhouses facing life-saving appliances, embarkation and external assembly station areas, external stairs and open decks used for escape routes. Stairway enclosure doors need not meet this requirement.
- 4.1.1.7** Except for watertight doors, weathertight doors (semi-watertight doors), doors leading to the open deck and doors which need to be reasonably gastight, all "A" class doors located in stairways, public spaces and main vertical zone bulkheads in escape routes shall be equipped with a self-closing hose port. The material, construction and fire resistance of the hose port shall be equivalent to the door into which it is fitted, and shall be a 150 mm square clear opening with the door closed and shall be inset into the lower edge of the

door, opposite the door hinges or, in the case of sliding doors, nearest the opening.

4.1.1.8 Where it is necessary that a ventilation duct passes through a main vertical zone division, a fail-safe automatic closing fire damper shall be fitted adjacent to the division. The damper shall also be capable of being manually closed from each side of the division. The operating position shall be readily accessible and be marked in red light-reflecting colour. The duct between the division and the damper shall be of steel or other equivalent material and, if necessary, insulated to comply with the requirements of paragraph 3.1. The damper shall be fitted on at least one side of the division with a visible indicator showing whether the damper is in the open position.

4.1.1.9 *It may not be possible to keep doors to ro/ro spaces permanently secured in the open position.*

4.1.2 Openings in "B" class divisions

4.1.2.1 Doors and door frames in "B" class divisions and means of securing them shall provide a method of closure which shall have resistance to fire equivalent to that of the divisions, this being determined in accordance with the Fire Test Procedures Code except that ventilation openings may be permitted in the lower portion of such doors. Where such opening is in or under a door, the total net area of any such opening or openings shall not exceed 0.05 m². Alternatively, a non-combustible air balance duct routed between the cabin and the corridor, and located below the sanitary unit, is permitted where the cross-sectional area of the duct does not exceed 0.05m². All ventilation openings shall be fitted with a grill made of non-combustible material. Doors shall be non-combustible. Doors approved without the sill being part of the frame, which are installed on or after 1 July 2010, shall be installed such that the gap under the door does not exceed 25 mm.

4.1.2.2 Cabin doors in "B" class divisions shall be of a self-closing type. Hold-back hooks are not permitted.

4.1.2.3 The requirements for "B" class integrity of the outer boundaries of a ship shall not apply to glass partitions, windows and sidescuttles. Similarly, the requirements for "B" class integrity shall not apply to exterior doors in superstructures and deckhouses. For ships carrying not more than 36 passengers, the Administration may permit the use of combustible materials in doors separating cabins from the individual interior sanitary spaces such as showers.

4.1.2.4 In ships carrying not more than 36 passengers, where an automatic sprinkler system complying with the provisions of the Fire Safety Systems Code is fitted:

4.1.2.4.1 openings in decks not forming steps in main vertical zones nor bounding horizontal zones shall be closed reasonably tight and such decks shall meet the "B" class integrity requirements in so far as is reasonable and practicable in the opinion of the Administration; and

4.1.2.4.2 openings in corridor bulkheads of "B" class materials shall be protected in accordance with the provisions of paragraph 2.2.2.

4.1.3 Windows and sidescuttles

4.1.3.1 Windows and sidescuttles in bulkheads within accommodation and service spaces and control stations other than those to which the provisions of paragraphs 4.1.1.6 and 4.1.2.3 apply shall be so constructed as to preserve the integrity requirements of the type of bulkheads in which they are fitted, this being determined in accordance with the Fire Test Procedures Code.

4.1.3.2 Notwithstanding the requirements of tables 9.1 to 9.4, windows and sidescuttles in bulkheads separating accommodation and service spaces and control stations from weather shall be constructed with frames of steel or other suitable material. The glass shall be retained by a metal glazing bead or angle.

4.1.3.3 Windows facing life-saving appliances, embarkation and assembly stations, external stairs and open decks used for escape routes, and windows situated below liferaft and escape slide embarkation areas shall have fire integrity as required in table 9.1 Where automatic dedicated sprinkler heads are provided for windows, "A-0" windows may be accepted as equivalent. To be considered under this paragraph, the sprinkler heads shall either be:

4.1.3.3.1 dedicated heads located above the windows, and installed in addition to the conventional ceiling sprinklers; or

4.1.3.3.2 conventional ceiling sprinkler heads arranged such that the window is protected by an average application rate of at least 5 l/m² and the additional window area is included in the calculation of the area of coverage; or

4.1.3.3.3 water-mist nozzles that have been tested and approved in accordance with the guidelines approved by the Administration.⁴

Windows located in the ship's side below the lifeboat embarkation area shall have fire integrity at least equal to "A-0" class.

4.2 Doors in fire-resisting divisions in cargo ships

4.2.1 The fire resistance of doors shall be equivalent to that of the division in which they are fitted, this being determined in accordance with the Fire Test Procedures Code. Doors and door frames in "A" class divisions shall be constructed of steel. Doors in "B" class divisions shall be non-combustible. Doors fitted in boundary bulkheads of machinery spaces of category A shall be reasonably gastight and self-closing. In ships constructed according to method IC, the Administration may permit the use of combustible materials in doors separating cabins from individual interior sanitary accommodation such as showers. Doors approved as "A" class without the sill being part of the frame, which are installed on or after 1 July 2010, shall be installed such that the gap under the door does not exceed 12 mm and a non-combustible sill shall be

⁴ Refer to the Revised Guidelines for approval of sprinkler systems, resolution A.800(19)).

installed under the door such that floor coverings do not extend beneath the closed door. Doors approved as "B" class without the sill being part of the frame, which are installed on or after 1 July 2010, shall be installed such that the gap under the door does not exceed 25 mm.

4.2.2 Doors required to be self-closing shall not be fitted with hold-back hooks. However, hold-back arrangements fitted with remote release devices of the fail-safe type may be utilized.

4.2.3 In corridor bulkheads, ventilation openings may be permitted in and under the doors of cabins and public spaces. Ventilation openings are also permitted in "B" class doors leading to lavatories, offices, pantries, lockers and store-rooms. Except as permitted below, the openings shall be provided only in the lower half of a door. Where such an opening is in or under a door, the total net area of any such opening or openings shall not exceed 0.05 m². Alternatively, a non-combustible air balance duct routed between the cabin and the corridor, and located below the sanitary unit, is permitted where the cross-sectional area of the duct does not exceed 0.05 m². Ventilation openings, except those under the door, shall be fitted with a grill made of non-combustible material.

4.2.4 Watertight doors need not be insulated.

5 Protection of openings in machinery spaces boundaries

5.1 Application

5.1.1 The provision of this paragraph shall apply to machinery spaces of category A and, where the Administration considers it desirable, to other machinery spaces.

5.2 Protection of openings in machinery space boundaries

5.2.1 The number of skylights, doors, ventilators, openings in funnels to permit exhaust ventilation and other openings to machinery spaces shall be reduced to a minimum consistent with the needs of ventilation and the proper and safe working of the ship.

5.2.2 Skylights shall be of steel and shall not contain glass panels.

5.2.3 Means of control shall be provided for closing power-operated doors or actuating release mechanisms on doors other than power-operated watertight doors. The controls shall be located outside the space concerned, where they will not be cut off in the event of fire in the space it serves.

5.2.4 In passenger ships, the means of control required in paragraph 5.2.3 shall be situated at one control position or grouped in as few positions as possible, to the satisfaction of the Administration. Such positions shall have safe access from the open deck.

5.2.5 In passenger ships, doors, other than power-operated watertight doors, shall be so arranged that positive closure is assured in case of fire in the space by power-operated closing arrangements or by the provision of self-closing doors capable of closing against an inclination of 3.5° opposing closure, and having a fail-safe hold-back arrangement, provided with a remotely operated release device.

5.2.6 Windows shall not be fitted in machinery space boundaries. However, this does not preclude the use of glass in control rooms within the machinery spaces.

6 Protection of cargo space boundaries

6.1 In passenger ships carrying more than 36 passengers, the boundary bulkheads and decks of special category spaces shall be insulated to "A-60" class standard. However,

where a category (5), (9) or (10) space, as defined in paragraph 2.2.3, is on one side of the division, the standard may be reduced to "A-0". Where fuel oil tanks are below a special category space, the integrity of the deck between such spaces may be reduced to "A-0" standard.

- 6.2 In passenger ships carrying not more than 36 passengers, the boundary bulkheads of special category spaces shall be insulated as required for category (11) spaces in table 9.3 and the horizontal boundaries as required for category (11) spaces in table 9.4.
- 6.3 In passenger ships carrying not more than 36 passengers, the boundary bulkheads and decks of closed and open ro-ro spaces shall have a fire integrity as required for category (8) spaces in table 9.3 and the horizontal boundaries as required for category (8) spaces in table 9.4.
- 6.4 In passenger ships, indicators shall be provided on the navigation bridge which shall indicate when any fire door leading to or from the special category spaces is closed.
- 6.5 In tankers, for the protection of cargo tanks carrying crude oil and petroleum products having a flashpoint not exceeding 60°C, materials readily rendered ineffective by heat shall not be used for valves, fittings, tank opening covers, cargo vent piping, and cargo piping so as to prevent the spread of fire to the cargo.

7 Ventilation systems

7.1 Duct and dampers

7.1.1 Ventilation ducts shall be of steel or equivalent material. However, short ducts, not generally exceeding 2 m in length and with a free cross-sectional area not exceeding 0.02 m², need not be steel or equivalent, subject to the following conditions:

7.1.1.1 subject to paragraph 7.1.1.2 the ducts are made of any material which has low flame-spread characteristics;

7.1.1.2 on ships constructed on or after 1 July 2010, the ducts shall be made of heat resisting non-combustible material, which may be faced internally and externally with membranes having low flame-spread characteristics and, in each case, a calorific value⁵ not exceeding 45 MJ/m² of their surface area for the thickness used;

7.1.1.3 the ducts are only used at the end of the ventilation device; and

7.1.1.4 the ducts are not situated less than 600 mm, measured along the duct, from an opening in an "A" or "B" class division, including continuous "B" class ceiling.

7.1.2 The following arrangements shall be tested in accordance with the Fire Test Procedures Code:

7.1.2.1 fire dampers, including their relevant means of operation; and

7.1.2.2 duct penetrations through "A" class divisions. However, the test is not required where steel sleeves are directly joined to ventilation ducts by means of riveted or screwed flanges or by welding.

7.2 Arrangement of ducts

7.2.1 The ventilation systems for machinery spaces of category A, vehicle spaces, ro-ro spaces, galleys, special category spaces and cargo spaces shall, in general, be separated from each other and from the ventilation systems serving other spaces, except that the galley ventilation systems on cargo ships of less than 4,000 gross tonnage and in passenger ships carrying not more than 36

⁵ Refer to the recommendations published by the International Organization for Standardization, in particular publication ISO 1716:2002, *Determination of calorific potential*.

passengers need not be completely separated, but may be served by separate ducts from a ventilation unit serving other spaces. In any case, an automatic fire damper shall be fitted in the galley ventilation duct near the ventilation unit. Ducts provided for the ventilation of machinery spaces of category A, galleys, vehicle spaces, ro-ro spaces or special category spaces shall not pass through accommodation spaces, service spaces or control stations unless they comply with the conditions specified in paragraphs 7.2.1.1.1 to 7.2.1.1.4 or 7.2.1.2.1 and 7.2.1.2.2 below:

7.2.1.1

7.2.1.1.1 the ducts are constructed of steel having a thickness of at least 3 mm and 5 mm for ducts the widths or diameters of which are up to and including 300 mm and 760 mm and over respectively and, in the case of such ducts, the widths or diameters of which are between 300 mm and 760 mm, having a thickness obtained by interpolation;

7.2.1.1.2 the ducts are suitably supported and stiffened;

7.2.1.1.3 the ducts are fitted with automatic fire dampers close to the boundaries penetrated; and

7.2.1.1.4 the ducts are insulated to "A-60" class standard from the machinery spaces, galleys, vehicle spaces, ro-ro spaces or special category spaces to a point at least 5 m beyond each fire damper;

or

7.2.1.2

7.2.1.2.1 the ducts are constructed of steel in accordance with paragraphs 7.2.1.1.1 and 7.2.1.1.2; and

7.2.1.2.2 the ducts are insulated to "A-60" class standard throughout the accommodation spaces, service spaces or control stations;

except that penetrations of main zone divisions shall also comply with the requirements of paragraph 4.1.1.8.

7.2.2 Ducts provided for ventilation to accommodation spaces, service spaces or control stations shall not pass through machinery spaces of category A, galleys, vehicle spaces, ro-ro spaces or special category spaces unless they comply with the conditions specified in paragraphs 7.2.2.1.1 to 7.2.2.1.3 or 7.2.2.2.1 and 7.2.2.2.2 below:

7.2.2.1

7.2.2.1.1 the ducts, where they pass through a machinery space of category A, galley, vehicle space, ro-ro space or special category space, are constructed of steel in accordance with paragraphs 7.2.1.1.1 and 7.2.1.1.2;

7.2.2.1.2 automatic fire dampers are fitted close to the boundaries penetrated; and

7.2.2.1.3 the integrity of the machinery space, galley, vehicle space, ro-ro space or special category space boundaries is maintained at the penetrations; or

7.2.2.2

7.2.2.2.1 the ducts, where they pass through a machinery space of category A, galley, vehicle space, ro-ro space or special category space, are constructed of steel in accordance with paragraphs 7.2.1.1.1 and 7.2.1.1.2; and

7.2.2.2.2 the ducts are insulated to "A-60" standard within the machinery space, galley, vehicle space, ro-ro space or special category space;
except that penetrations of main zone divisions shall also comply with the requirements of paragraph 4.1.1.8.

7.3 Details of duct penetrations

7.3.1 Where a thin plated duct with a free cross-sectional area equal to, or less than, 0.02 m^2 passes through "A" class bulkheads or decks, the opening shall be lined with a steel sheet sleeve having a thickness of at least 3 mm and a length of at least 200 mm, divided preferably into 100 mm on each side of the bulkhead or, in the case of the deck, wholly laid on the lower side of the decks pierced. Where ventilation ducts with a free cross-sectional area exceeding 0.02 m^2 pass through "A" class bulkheads or decks, the opening shall be lined with a steel sheet sleeve. However, where such ducts are of steel construction and pass through a deck or bulkhead, the ducts and sleeves shall comply with the following:

7.3.1.1 The sleeves shall have a thickness of at least 3 mm and a length of at least 900 mm. When passing through bulkheads, this length shall be divided preferably into 450 mm on each side of the bulkhead. These ducts, or sleeves lining such ducts, shall be provided with fire insulation. The insulation shall have at least the same fire integrity as the bulkhead or deck through which the duct passes; and

7.3.1.2 Ducts with a free cross-sectional area exceeding 0.075 m^2 shall be fitted with fire dampers in addition to the requirements of paragraph 7.3.1.1. The fire damper shall operate automatically, but shall also be capable of being closed manually from both sides of the bulkhead or deck. The damper shall be provided with an indicator which shows whether the damper is open or closed. Fire dampers are not required, however, where ducts pass through spaces surrounded by "A" class divisions, without serving those spaces, provided those ducts have the same fire integrity as the divisions which they pierce. Fire dampers shall be easily accessible. Where they are placed behind ceilings or linings, these ceilings or linings shall be provided with an inspection door on which a plate reporting the identification number of the fire damper is provided. The fire damper identification number shall also be placed on any remote controls required.

7.3.2 Ventilation ducts with a free cross-sectional area exceeding 0.02 m^2 passing through "B" class bulkheads shall be lined with steel sheet sleeves of 900 mm in length, divided preferably into 450 mm on each side of the bulkheads unless the duct is of steel for this length.

7.4 Ventilation systems for passenger ships carrying more than 36 passengers

7.4.1 The ventilation system of a passenger ship carrying more than 36 passengers shall be in compliance with the following additional requirements.

- 7.4.2** In general, the ventilation fans shall be so disposed that the ducts reaching the various spaces remain within the main vertical zone.
- 7.4.3** Where ventilation systems penetrate decks, precautions shall be taken, in addition to those relating to the fire integrity of the deck required by paragraphs 3.1 and 4.1.1.5, to reduce the likelihood of smoke and hot gases passing from one 'tween-deck space to another through the system. In addition to insulation requirements contained in paragraph 7.4, vertical ducts shall, if necessary, be insulated as required by the appropriate tables 9.1 and 9.2.
- 7.4.4** Except in cargo spaces, ventilation ducts shall be constructed of the following materials:
- 7.4.4.1** ducts not less than 0.075 m² in free cross-sectional area and all vertical ducts serving more than a single 'tween-deck space shall be constructed of steel or other equivalent material;
 - 7.4.4.2** ducts less than 0.075 m² in free cross-sectional area, other than the vertical ducts referred to in paragraph 7.4.4.1, shall be constructed of steel or equivalent materials. Where such ducts penetrate "A" or "B" class divisions, due regard shall be given to ensuring the fire integrity of the division; and
 - 7.4.4.3** short lengths of duct, not in general exceeding 0.02 m² in free cross-sectional area nor 2 m in length, need not be steel or equivalent provided that all of the following conditions are met:
 - 7.4.4.3.1** subject to paragraph 7.4.4.3.2 the duct is constructed of any material which has low flame-spread characteristics;
 - 7.4.4.3.2** on ships constructed on or after 1 July 2010, the ducts shall be made of heat resisting non-combustible material, which may be faced internally and externally with membranes having low flame-spread characteristics and, in each case, a calorific value⁶ not exceeding 45 MJ/m² of their surface area for the thickness used;
 - 7.4.4.3.3** the duct is used only at the terminal end of the ventilation system; and
 - 7.4.4.3.4** the duct is not located closer than 600 mm measured along its length to a penetration of an "A" or "B" class division, including continuous "B" class ceilings.
- 7.4.5** Stairway enclosures shall be ventilated and served by an independent fan and duct system which shall not serve any other spaces in the ventilation systems.
- 7.4.6** Exhaust ducts shall be provided with hatches for inspection and cleaning. The hatches shall be located near the fire dampers.
- 7.5 Exhaust ducts from galley ranges**
- 7.5.1.1** Requirements for passenger ships carrying more than 36 passengers
Exhaust ducts from galley ranges shall meet the requirements of paragraphs 7.2.1.2.1 and 7.2.1.2.2 and shall be fitted with:
 - 7.5.1.1.1** a grease trap readily removable for cleaning unless an alternative approved grease removal system is fitted;
 - 7.5.1.1.2** a fire damper located in the lower end of the duct which is automatically and remotely operated and, in addition, a

⁶ Refer to the recommendations published by the International Organization for Standardization, in particular publication ISO 1716:2002, *Determination of calorific potential*.

remotely operated fire damper located in the upper end of the duct;

7.5.1.1.3 a fixed means for extinguishing a fire within the duct;

7.5.1.1.4 remote-control arrangements for shutting off the exhaust fans and supply fans, for operating the fire dampers mentioned in paragraph 7.5.1.2 and for operating the fire-extinguishing system, which shall be placed in a position close to the entrance to the galley. Where a multi-branch system is installed, a remote means located with the above controls shall be provided to close all branches exhausting through the same main duct before an extinguishing medium is released into the system; and

7.5.1.1.5 suitably located hatches for inspection and cleaning.

7.5.1.2 Exhaust ducts from ranges for cooking equipment installed on open decks shall conform to paragraph 7.5.1.1, as applicable, when passing through accommodation spaces or spaces containing combustible materials.

7.5.2 Requirements for cargo ships and passenger ships carrying not more than 36 passengers

7.5.2.1 Where they pass through accommodation spaces or spaces containing combustible materials, the exhaust ducts from galley ranges shall be constructed of "A" class divisions. Each exhaust duct shall be fitted with:

7.5.2.1.1 a grease trap readily removable for cleaning;

7.5.2.1.2 a fire damper located in the lower end of the duct and, in addition, a fire damper in the upper end of the duct;

7.5.2.1.3 arrangements, operable from within the galley, for shutting off the exhaust fans; and

7.5.2.1.4 fixed means for extinguishing a fire within the duct.

7.6 Ventilation systems for main laundries in ships carrying more than 36 passengers

Exhaust ducts from main laundries shall be fitted with:

7.6.1 filters readily removable for cleaning purposes;

7.6.2 a fire damper located in the lower end of the duct which is automatically and remotely operated;

7.6.3 remote-control arrangements for shutting off the exhaust fans and supply fans from within the space and for operating the fire damper mentioned in paragraph 7.6.2; and

7.6.4 suitably located hatches for inspection and cleaning.

Regulation 10 – Fire fighting

1 Purpose

The purpose of this regulation is to suppress and swiftly extinguish a fire in the space of origin. For this purpose, the following functional requirements shall be met:

1.1 fixed fire-extinguishing systems shall be installed, having due regard to the fire growth potential of the protected spaces; and

1.2 fire-extinguishing appliances shall be readily available.

2 Water supply systems

Ships shall be provided with fire pumps, fire mains, hydrants and hoses complying with the applicable requirements of this regulation.

2.1 Fire mains and hydrants

2.1.1 General

Materials readily rendered ineffective by heat shall not be used for fire mains and hydrants unless adequately protected. The pipes and hydrants shall be so placed that the fire hoses may be easily coupled to them. The arrangement of pipes and hydrants shall be such as to avoid the possibility of freezing. Suitable drainage provisions shall be provided for fire main piping. Isolation valves shall be installed for all open deck fire main branches used for purposes other than fire fighting. In ships where deck cargo may be carried, the positions of the hydrants shall be such that they are always readily accessible and the pipes shall be arranged as far as practicable to avoid risk of damage by such cargo.

2.1.2 Ready availability of water supply

The arrangements for the ready availability of water supply shall be:

2.1.2.1 in passenger ships:

2.1.2.1.1 of 1,000 gross tonnage and upwards such that at least one effective jet of water is immediately available from any hydrant in an interior location and so as to ensure the continuation of the output of water by the automatic starting of one required fire pump;

2.1.2.1.2 of less than 1,000 gross tonnage by automatic start of at least one fire pump or by remote starting from the navigation bridge of at least one fire pump. If the pump starts automatically or if the bottom valve cannot be opened from where the pump is remotely started, the bottom valve shall always be kept open; and

2.1.2.1.3 if fitted with periodically unattended machinery spaces in accordance with regulation II-1/54, the Administration shall determine provisions for fixed water fire-extinguishing arrangements for such spaces equivalent to those required for normally attended machinery spaces;

2.1.2.2 in cargo ships:

2.1.2.2.1 to the satisfaction of the Administration; and

2.1.2.2.2 with a periodically unattended machinery space or when only one person is required on watch, there shall be immediate water delivery from the fire main system at a suitable pressure, either by remote starting of one of the main fire pumps with remote starting from the navigation bridge and fire control station, if any, or permanent pressurization of the fire main system by one of the main fire pumps, except that the Administration may waive this requirement for cargo ships of less than 1,600 gross tonnage if the fire pump starting arrangement in the machinery space is in an easily accessible position.

2.1.3 Diameter of fire mains

The diameter of the fire main and water service pipes shall be sufficient for the effective distribution of the maximum required discharge from two fire pumps operating

simultaneously, except that in the case of cargo ships the diameter need only be sufficient for the discharge of 140 m³/h.

2.1.4 Isolating valves and relief valves

2.1.4.1 Isolating valves to separate the section of the fire main within the machinery space containing the main fire pump or pumps from the rest of the fire main shall be fitted in an easily accessible and tenable position outside the machinery spaces. The fire main shall be so arranged that when the isolating valves are shut all the hydrants on the ship, except those in the machinery space referred to above, can be supplied with water by another fire pump or an emergency fire pump. The emergency fire pump, its seawater inlet, and suction and delivery pipes and isolating valves shall be located outside the machinery space. If this arrangement cannot be made, the sea-chest may be fitted in the machinery space if the valve is remotely controlled from a position in the same compartment as the emergency fire pump and the suction pipe is as short as practicable. Short lengths of suction or discharge piping may penetrate the machinery space, provided they are enclosed in a substantial steel casing or are insulated to "A-60" class standards. The pipes shall have substantial wall thickness, but in no case less than 11 mm, and shall be welded except for the flanged connection to the sea inlet valve.

2.1.4.2 A valve shall be fitted to serve each fire hydrant so that any fire hose may be removed while the fire pumps are in operation.

2.1.4.3 Relief valves shall be provided in conjunction with fire pumps if the pumps are capable of developing a pressure exceeding the design pressure of the water service pipes, hydrants and hoses. These valves shall be so placed and adjusted as to prevent excessive pressure in any part of the fire main system.

2.1.4.4 In tankers, isolation valves shall be fitted in the fire main at the poop front in a protected position and on the tank deck at intervals of not more than 40 m to preserve the integrity of the fire main system in case of fire or explosion.

2.1.5 Number and position of hydrants

2.1.5.1 The number and position of hydrants shall be such that at least two jets of water not emanating from the same hydrant, one of which shall be from a single length of hose, may reach any part of the ship normally accessible to the passengers or crew while the ship is being navigated and any part of any cargo space when empty, any ro-ro space or any vehicle space, in which latter case the two jets shall reach any part of the space, each from a single length of hose. Furthermore, such hydrants shall be positioned near the accesses to the protected spaces.

2.1.5.2 In addition to the requirements in paragraph 2.1.5.1, passenger ships shall comply with the following:

2.1.5.2.1 in the accommodation, service and machinery spaces, the number and position of hydrants shall be such that the requirements of paragraph 2.1.5.1 may be complied with

when all watertight doors and all doors in main vertical zone bulkheads are closed; and

2.1.5.2.2 where access is provided to a machinery space of category A at a low level from an adjacent shaft tunnel, two hydrants shall be provided external to, but near the entrance to, that machinery space. Where such access is provided from other spaces, in one of those spaces two hydrants shall be provided near the entrance to the machinery space of category A. Such provision need not be made where the tunnel or adjacent spaces are not part of the escape route.

2.1.6 Pressure at hydrants

With the two pumps simultaneously delivering water through the nozzles specified in paragraph 2.3.3, with the quantity of water as specified in paragraph 2.1.3, through any adjacent hydrants, the following minimum pressures shall be maintained at all hydrants:

.1 for passenger ships:

4,000 gross tonnage and upwards	0.40 N/mm ²
less than 4,000 gross tonnage	0.30 N/mm ²

.2 for cargo ships:

6,000 gross tonnage and upwards	0.27 /mm ²
less than 6,000 gross tonnage	0.25 /mm ²

.3 the maximum pressure at any hydrant shall not exceed that at which the effective control of a fire hose can be demonstrated.

2.1.7 International shore connection

2.1.7.1 Ships of 500 gross tonnage and upwards shall be provided with at least one international shore connection complying with the Fire Safety Systems Code.

2.1.7.2 Facilities shall be available enabling such a connection to be used on either side of the ship.

2.2 Fire pumps

2.2.1 Pumps accepted as fire pumps

Sanitary, ballast, bilge or general service pumps may be accepted as fire pumps, provided that they are not normally used for pumping oil and that if they are subject to occasional duty for the transfer or pumping of oil fuel, suitable change-over arrangements are fitted.

2.2.2 Number of fire pumps

Ships shall be provided with independently driven fire pumps as follows:

.1 in passenger ships of:

4,000 gross tonnage and upwards	at least three
less than 4,000 gross tonnage	at least two

.2 in cargo ships of:

1,000 gross tonnage and upwards	at least two
less than 1,000 gross tonnage <i>but above 150</i>	at least two power driven pumps, one of which shall be independently driven

2.2.3 Arrangement of fire pumps and fire mains

2.2.3.1 Fire pumps

The arrangement of sea connections, fire pumps and their sources of power shall be as to ensure that:

2.2.3.1.1 in passenger ships of 1,000 gross tonnage and upwards, in the event of a fire in any one compartment, all the fire pumps will not be put out of action; and

2.2.3.1.2 in passenger ships of less than 1,000 gross tonnage and in cargo ships *of more than 150 gross tonnage*, if a fire in any one compartment could put all the pumps out of action, there shall be an alternative means consisting of an emergency fire pump complying with the provisions of the Fire Safety Systems Code with its source of power and sea connection located outside the space where the main fire pumps or their sources of power are located.

2.2.3.2 Requirements for the space containing the emergency fire pump

2.2.3.2.1 Location of the space

The space containing the fire pump shall not be contiguous to the boundaries of machinery spaces of category A or those spaces containing main fire pumps. Where this is not practicable, the common bulkhead between the two spaces shall be insulated to a standard of structural fire protection equivalent to that required for a control station in regulation 9.2.3.3.

2.2.3.2.2 Access to the emergency fire pump

No direct access shall be permitted between the machinery space and the space containing the emergency fire pump and its source of power. When this is impracticable, the Administration may accept an arrangement where the access is by means of an airlock with the door of the machinery space being of "A-60" class standard and the other door being at least steel, both reasonably gastight, self-closing and without any hold-back arrangements. Alternatively, the access may be through a watertight door capable of being operated from a space remote from the machinery space and the space containing the emergency fire pump and unlikely to be cut off in the event of fire in those spaces. In such cases, a second means of access to the space containing the emergency fire pump and its source of power shall be provided.

2.2.3.2.3 Ventilation of the emergency fire pump space

Ventilation arrangements to the space containing the independent source of power for the emergency fire pump shall be such as to preclude, as far as practicable, the possibility of smoke from a machinery space fire entering or being drawn into that space.

2.2.3.3 Additional pumps for cargo ships

In addition, in cargo ships where other pumps, such as general service, bilge and ballast, etc., are fitted in a machinery space, arrangements shall be made to ensure that at least one of these pumps, having the

capacity and pressure required by paragraphs 2.1.6.2 and 2.2.4.2, is capable of providing water to the fire main.

2.2.4 Capacity of fire pumps

2.2.4.1 Total capacity of required fire pumps

The required fire pumps shall be capable of delivering for fire-fighting purposes a quantity of water, at the pressure specified in paragraph 2.1.6, as follows:

2.2.4.1.1 pumps in passenger ships: the quantity of water is not less than two thirds of the quantity required to be dealt with by the bilge pumps when employed for bilge pumping; and

2.2.4.1.2 pumps in cargo ships, other than any emergency pump: the quantity of water is not less than four thirds of the quantity required under regulation II-1/35-1 to be dealt with by each of the independent bilge pumps in a passenger ship of the same dimension when employed in bilge pumping, provided that in no cargo ship need the total required capacity of the fire pumps exceed 180 m³/h.

2.2.4.2 Capacity of each fire pump

Each of the required fire pumps (other than any emergency pump required in paragraph 2.2.3.1.2 for cargo ships) shall have a capacity not less than 80% of the total required capacity divided by the minimum number of required fire pumps, but in any case not less than 25 m³/h, and each such pump shall in any event be capable of delivering at least the two required jets of water. These fire pumps shall be capable of supplying the fire main system under the required conditions. Where more pumps than the minimum of required pumps are installed, such additional pumps shall have a capacity of at least 25 m³/h and shall be capable of delivering at least the two jets of water required in paragraph 2.1.5.1.

2.3 Fire hoses and nozzles

2.3.1 General specifications

Fire hoses shall be of non-perishable material approved by the Administration and shall be sufficient in length to project a jet of water to any of the spaces in which they may be required to be used. Each hose shall be provided with a nozzle and the necessary couplings. Hoses specified in this chapter as "fire hoses" shall, together with any necessary fittings and tools, be kept ready for use in conspicuous positions near the water service hydrants or connections. Additionally, in interior locations in passenger ships carrying more than 36 passengers, fire hoses shall be connected to the hydrants at all times. Fire hoses shall have a length of at least 10 m, but not more than:

.1 15 m in machinery spaces;

.2 20 m in other spaces and open decks; and

.3 25 m for open decks on ships with a maximum breadth in excess of 30 m.

2.3.1.1 Unless one hose and nozzle is provided for each hydrant in the ship, there shall be complete interchangeability of hose couplings and nozzles.

2.3.2 Number and diameter of fire hoses

2.3.2.1 Ships shall be provided with fire hoses, the number and diameter of which shall be to the satisfaction of the Administration.

2.3.2.2 In passenger ships, there shall be at least one fire hose for each of the hydrants required by paragraph 2.1.5 and these hoses shall be used only for the purposes of extinguishing fires or testing the fire-extinguishing apparatus at fire drills and surveys.

2.3.2.2.1 In cargo ships:

2.3.2.2.1.1 of 1,000 gross tonnage and upwards, the number of fire hoses to be provided shall be one for each 30 m length of the ship and one spare, but in no case less than five in all. This number does not include any hoses required in any engine room or boiler room. The Administration may increase the number of hoses required so as to ensure that hoses in sufficient number are available and accessible at all times, having regard to the type of ship and the nature of trade in which the ship is employed. Ships carrying dangerous goods in accordance with regulation 19 shall be provided with three hoses and nozzles, in addition to those required above; and

2.3.2.2.1.2 of less than 1,000 gross tonnage *but of more than 150 gross tonnage*, the number of fire hoses to be provided shall be calculated in accordance with the provisions of paragraph 2.3.2.3.1. However, the number of hoses shall in no case be less than three.

2.3.3 Size and types of nozzles

2.3.3.1 For the purposes of this chapter, standard nozzle sizes shall be 12 mm, 16 mm and 19 mm or as near thereto as possible. Larger diameter nozzles may be permitted at the discretion of the Administration.

2.3.3.2 For accommodation and service spaces, a nozzle size greater than 12 mm need not be used.

2.3.3.3 For machinery spaces and exterior locations, the nozzle size shall be such as to obtain the maximum discharge possible from two jets at the pressure mentioned in paragraph 2.1.6 from the smallest pump, provided that a nozzle size greater than 19 mm need not be used.

2.3.3.4 Nozzles shall be of an approved dual-purpose type (i.e. spray/jet type) incorporating a shutoff.

3 Portable fire extinguishers

3.1 Type and design

Portable fire extinguishers shall comply with the requirements of the Fire Safety Systems Code *and be subjected to inspections in pursuance of the provisions of annex N(3) to this chapter.*

3.2 Arrangement of fire extinguishers

- 3.2.1 Accommodation spaces, service spaces and control stations shall be provided with portable fire extinguishers of appropriate types and in sufficient number to the satisfaction of the Administration. Ships of 1,000 gross tonnage and upwards shall carry at least five portable fire extinguishers.
- 3.2.2 One of the portable fire extinguishers intended for use in any space shall be stowed near the entrance to that space.
- 3.2.3 Carbon dioxide fire extinguishers shall not be placed in accommodation spaces. In control stations and other spaces containing electrical or electronic equipment or appliances necessary for the safety of the ship, fire extinguishers shall be provided whose extinguishing media are neither electrically conductive nor harmful to the equipment and appliances.
- 3.2.4 Fire extinguishers shall be situated ready for use at easily visible places, which can be reached quickly and easily at any time in the event of a fire, and in such a way that their serviceability is not impaired by the weather, vibration or other external factors. Portable fire extinguishers shall be provided with devices which indicate whether they have been used.

3.3 Spare charges

- 3.3.1 Spare charges shall be provided for 100% of the first ten extinguishers and 50% of the remaining fire extinguishers capable of being recharged on board. Not more than sixty total spare charges are required. Instructions for recharging shall be carried on board.
- 3.3.2 For fire extinguishers which cannot be recharged on board, additional portable fire extinguishers of the same quantity, type, capacity and number as determined in paragraph 3.3.1 above shall be provided in lieu of spare charges.

4 Fixed fire-extinguishing systems

4.1 Types of fixed fire-extinguishing systems

- 4.1.1 A fixed fire-extinguishing system required by paragraph 5 below may be any of the following systems:
 - 4.1.1.1 a fixed gas fire-extinguishing system complying with the provisions of the Fire Safety Systems Code *and the provisions of annexes N(1) and N(2) to this chapter*;
 - 4.1.1.2 a fixed high-expansion foam fire extinguishing system complying with the provisions of the Fire Safety Systems Code; and
 - 4.1.1.3 a fixed pressure water-spraying fire-extinguishing system complying with the provisions of the Fire Safety Systems Code.
- 4.1.2 Where a fixed fire-extinguishing system not required by this chapter is installed, it shall meet the requirements of the relevant regulations of this chapter and the Fire Safety Systems Code.
- 4.1.3 Fire-extinguishing systems using Halon 1211, 1301, and 2402 and perfluorocarbons shall be prohibited.
- 4.1.4 In general, the Administration shall not permit the use of steam as a fire-extinguishing medium in fixed fire-extinguishing systems. Where the use of steam is permitted by the Administration, it shall be used only in restricted areas as an addition to the required fire-extinguishing system and shall comply with the requirements of the Fire Safety System Code.

4.1.5 By the first scheduled dry-docking after 1 January 2010, fixed carbon dioxide fire-extinguishing systems for the protection of machinery spaces and cargo pump-rooms on ships constructed before 1 July 2002 shall comply with the provisions of paragraph 2.2.2 of chapter 5 of the Fire Safety Systems Code.

4.2 Closing appliances for fixed gas fire-extinguishing systems

Where a fixed gas fire-extinguishing system is used, openings which may admit air to, or allow gas to escape from, a protected space shall be capable of being closed from outside the protected space.

4.3 Storage rooms of fire-extinguishing medium

When the fire-extinguishing medium is stored outside a protected space, it shall be stored in a room which is located behind the forward collision bulkhead, and is used for no other purposes. Any entrance to such a storage room shall preferably be from the open deck and shall be independent of the protected space. If the storage space is located below deck, it shall be located no more than one deck below the open deck and shall be directly accessible by a stairway or ladder from the open deck. Spaces which are located below deck or spaces where access from the open deck is not provided shall be fitted with a mechanical ventilation system designed to take exhaust air from the bottom of the space and shall be sized to provide at least 6 air changes per hour. Access doors shall open outwards, and bulkheads and decks, including doors and other means of closing any opening therein, which form the boundaries between such rooms and adjacent enclosed spaces shall be gastight. For the purpose of the application of tables 9.1 to 9.8, such storage rooms shall be treated as fire control stations.

4.4 Water pumps for other fire-extinguishing systems

Pumps, other than those serving the fire main, required for the provision of water for fire-extinguishing systems required by this chapter, their sources of power and their controls shall be installed outside the space or spaces protected by such systems and shall be so arranged that a fire in the space or spaces protected will not put any such system out of action.

5 Fire-extinguishing arrangements in machinery spaces

5.1 Machinery spaces containing oil-fired boilers or oil fuel units

5.1.1 Fixed fire-extinguishing systems

Machinery spaces of category A containing oil-fired boilers or oil fuel units shall be provided with any one of the fixed fire-extinguishing systems in paragraph 4.1. In each case, if the engine-room and boiler room are not entirely separate, or if fuel oil can drain from the boiler room into the engine-room, the combined engine and boiler rooms shall be considered as one compartment.

5.1.2 Additional fire-extinguishing arrangements

5.1.2.1 There shall be in each boiler room or at an entrance outside of the boiler room at least one portable foam applicator unit complying with the provisions of the Fire Safety Systems Code.

5.1.2.2 There shall be at least two portable foam extinguishers or equivalent in each firing space in each boiler room and in each space in which a part of the oil fuel installation is situated. There shall be not less than one approved foam-type extinguisher of at least 135 l capacity or equivalent in each boiler room. These extinguishers shall be provided with hoses on reels suitable for reaching any part of the boiler room. In the case of domestic boilers of less than 175 kW an approved foam-type extinguisher of at least 135 l capacity is not required.

- 5.1.2.3** In each firing space there shall be a receptacle containing at least 0.1 m³ sand, sawdust impregnated with soda, or other approved dry material, along with a suitable shovel for spreading the material. An approved portable extinguisher may be substituted as an alternative.

5.2 Machinery spaces containing internal combustion machinery

5.2.1 Fixed fire-extinguishing systems

Machinery spaces of category A containing internal combustion machinery shall be provided with one of the fixed fire-extinguishing systems in paragraph 4.1.

5.2.2 Additional fire-extinguishing arrangements

5.2.2.1 There shall be at least one portable foam applicator unit complying with the provisions of the Fire Safety Systems Code.

5.2.2.2 There shall be in each such space approved foam-type fire extinguishers, each of at least 45 l capacity or equivalent, sufficient in number to enable foam or its equivalent to be directed onto any part of the fuel and lubricating oil pressure systems, gearing and other fire hazards. In addition, there shall be provided a sufficient number of portable foam extinguishers or equivalent which shall be so located that no point in the space is more than 10 m walking distance from an extinguisher and that there are at least two such extinguishers in each such space. For smaller spaces of cargo ships the Administration may consider relaxing this requirement.

5.3 Machinery spaces containing steam turbines or enclosed steam engines

5.3.1 Fixed fire-extinguishing systems

In spaces containing steam turbines or enclosed steam engines used for main propulsion or other purposes having in the aggregate a total output of not less than 375 kW, one of the fire-extinguishing systems specified in paragraph 4.1 shall be provided if such spaces are periodically unattended.

5.3.2 Additional fire-extinguishing arrangements

5.3.2.1 There shall be approved foam fire extinguishers, each of at least 45 l capacity or equivalent, sufficient in number to enable foam or its equivalent to be directed on to any part of the pressure lubrication system, on to any part of the casings enclosing pressure-lubricated parts of the turbines, engines or associated gearing, and any other fire hazards. However, such extinguishers shall not be required if protection, at least equivalent to that required by this subparagraph, is provided in such spaces by a fixed fire-extinguishing system fitted in compliance with paragraph 4.1.

5.3.2.2 There shall be a sufficient number of portable foam extinguishers or equivalent which shall be so located that no point in the space is more than 10 m walking distance from an extinguisher and that there are at least two such extinguishers in each such space, except that such extinguishers shall not be required in addition to any provided in compliance with paragraph 5.1.2.2.

5.4 Other machinery spaces

Where, in the opinion of the Administration, a fire hazard exists in any machinery space for which no specific provisions for fire-extinguishing appliances are prescribed in paragraphs 5.1, 5.2 and 5.3, there shall be provided in, or adjacent to, that space such a

number of approved portable fire extinguishers or other means of fire extinction as the Administration may deem sufficient.

5.5 Additional requirements for passenger ships

In passenger ships carrying more than 36 passengers, each machinery space of category A shall be provided with at least two suitable water fog applicators.⁷

5.6 Fixed local application fire-extinguishing systems

5.6.1 Paragraph 5.6 shall apply to passenger ships of 500 gross tonnage and above and cargo ships of 2,000 gross tonnage and above.

5.6.2 Machinery spaces of category A above 500 m³ in volume shall, in addition to the fixed fire-extinguishing system required in paragraph 5.1.1, be protected by an approved type of fixed water-based or equivalent local application fire-extinguishing system, based on the guidelines developed by the Organization.⁸ In the case of periodically unattended machinery spaces, the fire-extinguishing system shall have both automatic and manual release capabilities. In the case of continuously manned machinery spaces, the fire-extinguishing system is only required to have a manual release capability.

5.6.3 Fixed local application fire-extinguishing systems are to protect areas such as the following without the necessity of engine shutdown, personnel evacuation, or sealing of the spaces:

5.6.3.1 the fire hazard portions of internal combustion machinery used for the ship's main propulsion and power generation;

5.6.3.2 boiler fronts;

5.6.3.3 the fire hazard portions of incinerators; and

5.6.3.4 purifiers for heated fuel oil.

5.6.4 Activation of any local application system shall give a visual and distinct audible alarm in the protected space and at continuously manned stations. The alarm shall indicate the specific system activated. The system alarm requirements described within this paragraph are in addition to, and not a substitute for, the detection and fire alarm system required elsewhere in this chapter.

6 Fire-extinguishing arrangements in control stations, accommodation and service spaces

6.1 Sprinkler systems in passenger ships

6.1.1 Passenger ships carrying more than 36 passengers shall be equipped with an automatic sprinkler, fire detection and fire alarm system of an approved type complying with the requirements of the Fire Safety Systems Code in all control stations, accommodation and service spaces, including corridors and stairways. Alternatively, control stations, where water may cause damage to essential equipment, may be fitted with an approved fixed fire-extinguishing system of another type. Spaces having little or no fire risk such as voids, public toilets, carbon dioxide rooms and similar spaces need not be fitted with an automatic sprinkler system.

6.1.2 In passenger ships carrying not more than 36 passengers, when a fixed smoke detection and fire alarm system complying with the provisions of the Fire

⁷ A water fog applicator might consist of a metal L-shaped pipe, the long limb being about 2 m in length, capable of being fitted to a fire hose, and the short limb being about 250 mm in length, fitted with a fixed water fog nozzle or capable of being fitted with a water spray nozzle.

⁸ Refer to the Guidelines for the approval of fixed water-based local application fire-fighting systems for use in category A machinery spaces (MSC/Circ.913).

Safety Systems Code is provided only in corridors, stairways and escape routes within accommodation spaces, an automatic sprinkler system shall be installed in accordance with regulation 7.5.3.2.

- 6.1.3** A fixed pressure water-spraying fire-extinguishing system complying with the provisions of the Fire Safety System Code shall be installed on cabin balconies of ships to which regulation 5.3.4 applies, where furniture and furnishings on such balconies are not in as defined in regulations 3.40.1, 3.40.2, 3.40.3, 3.40.6 and 3.40.7.

6.2 Sprinkler systems for cargo ships

In cargo ships in which method IIC specified in regulation 9.2.3.1.1.2 is adopted, an automatic sprinkler, fire detection and fire alarm system shall be fitted in accordance with the requirements in regulation 7.5.3.2.

6.3 Spaces containing flammable liquid

- 6.3.1** Paint lockers shall be protected by:

- 6.3.1.1** a carbon dioxide system, designed to give a minimum volume of free gas equal to 40% of the gross volume of the protected space;
- 6.3.1.2** a dry powder system, designed for at least 0.5 kg powder/m³;
- 6.3.1.3** a water spraying or sprinkler system, designed for 5 l/m² min. Water spraying systems may be connected to the fire main of the ship; or
- 6.3.1.4** a system providing equivalent protection, as determined by the Administration. In all cases, the system shall be operable from outside the protected space.

- 6.3.2** Flammable liquid lockers shall be protected by an appropriate fire-extinguishing arrangement approved by the Administration.

- 6.3.3** For lockers of a deck area of less than 4 m², which do not give access to accommodation spaces, a portable carbon dioxide fire extinguisher sized to provide a minimum volume of free gas equal to 40% of the gross volume of the space may be accepted in lieu of a fixed system. A discharge port shall be arranged in the locker to allow the discharge of the extinguisher without having to enter into the protected space. The required portable fire extinguisher shall be stowed adjacent to the port. Alternatively, a port or hose connection may be provided to facilitate the use of fire main water.

6.4 Deep-fat cooking equipment

Deep-fat cooking equipment installed in enclosed spaces or on open decks shall be fitted with the following:

- 6.4.1** an automatic or manual fire-extinguishing system tested to an international standard acceptable to the Organization;⁹
- 6.4.2** a primary and backup thermostat with an alarm to alert the operator in the event of failure of either thermostat;
- 6.4.3** arrangements for automatically shutting off the electrical power upon activation of the fire-extinguishing system;
- 6.4.4** an alarm for indicating operation of the fire-extinguishing system in the galley where the equipment is installed; and
- 6.4.5** controls for manual operation of the fire-extinguishing system which are clearly labelled for ready use by the crew.

7 Fire-extinguishing arrangements in cargo spaces

⁹ Refer to the recommendations by the International Organization for Standardization, in particular publication ISO 15371:2000, Fire-extinguishing systems for protection of galley deep-fat cooking equipment – fire tests.

7.1 Fixed gas fire-extinguishing systems for general cargo

- 7.1.1** Except as provided for in paragraph 7.2, the cargo spaces of passenger ships of 1,000 gross tonnage and upwards shall be protected by a fixed carbon dioxide or inert gas fire-extinguishing system complying with the provisions of the Fire Safety Systems Code or by a fixed high-expansion foam fire-extinguishing system which gives equivalent protection.
- 7.1.2** Where it is shown to the satisfaction of the Administration that a passenger ship is engaged on voyages of such short duration that it would be unreasonable to apply the requirements of paragraph 7.1.1 and also in ships of less than 1,000 gross tonnage, the arrangements in cargo spaces shall be to the satisfaction of the Administration, provided that the ship is fitted with steel hatch covers and effective means of closing all ventilators and other openings leading to the cargo spaces.
- 7.1.3** Except for ro-ro and vehicle spaces, cargo spaces on cargo ships of 2,000 gross tonnage and upwards shall be protected by a fixed carbon dioxide or inert gas fire-extinguishing system complying with the provisions of the Fire Safety Systems Code, or by a fire-extinguishing system which gives equivalent protection.
- 7.1.4** The Administration may exempt from the requirements of paragraphs 1.1 and 1.2 cargo spaces of any cargo ship if constructed, and solely intended, for the carriage of ore, coal, grain, unseasoned timber, non-combustible cargoes or cargoes which, in the opinion of the Administration, constitute a low fire risk.¹⁰ Such exemptions may be granted only if the ship is fitted with steel hatch covers and effective means of closing all ventilators and other openings leading to the cargo spaces. When such exemptions are granted, the Administration shall issue an Exemption Certificate, irrespective of the date of construction of the ship concerned, in accordance with regulation I/12(a)(vii), and shall ensure that the list of cargoes the ship is permitted to carry is attached to the Exemption Certificate.

7.2 Fixed gas fire-extinguishing systems for dangerous goods

A ship engaged in the carriage of dangerous goods in any cargo spaces shall be provided with a fixed carbon dioxide or inert gas fire-extinguishing system complying with the provisions of the Fire Safety Systems Code or with a fire-extinguishing system which, in the opinion of the Administration, gives equivalent protection for the cargoes carried.

8 Cargo tank protection

8.1 Fixed deck foam fire-extinguishing systems

- 8.1.1** For tankers of 20,000 tonnes deadweight and upwards, a fixed deck foam fire-extinguishing system shall be provided complying with the provisions of the Fire Safety Systems Code, except that, in lieu of the above, the Administration, after having given consideration to the ship's arrangement and equipment, may accept other fixed installations if they afford protection equivalent to the above, in accordance with regulation I/5. The requirements for alternative fixed installations shall comply with the requirements in paragraph 8.1.2.

¹⁰ Refer to the Code of Safe Practice for Solid Bulk Cargoes, emergency schedule B14, entry for coal, and to the List of solid bulk cargoes which are non-combustible or constitute a low fire risk or for which a fixed gas fire-extinguishing system is ineffective (MSC/Circ.671)

- 8.1.2 In accordance with paragraph 8.1.1, where the Administration accepts an equivalent fixed installation in lieu of the fixed deck foam fire-extinguishing system, the installation shall:
 - 8.1.2.1 be capable of extinguishing spill fires and also preclude ignition of spilled oil not yet ignited; and
 - 8.1.2.2 be capable of combating fires in ruptured tanks.
- 8.1.3 Tankers of less than 20,000 tonnes deadweight shall be provided with a deck foam fire-extinguishing system complying with the requirements of the Fire Safety Systems Code.

9 Protection of cargo pump-rooms in tankers

9.1 Fixed fire-extinguishing systems

Each cargo pump-room shall be provided with one of the following fixed fire-extinguishing systems operated from a readily accessible position outside the pumproom. Cargo pump-rooms shall be provided with a system suitable for machinery spaces of category A.

- 9.1.1 A carbon dioxide fire-extinguishing system complying with the provisions of the Fire Safety Systems Code and with the following:
 - 9.1.1.1 the alarms giving audible warning of the release of fire-extinguishing medium shall be safe for use in a flammable cargo vapour/air mixture; and
 - 9.1.1.2 a notice shall be exhibited at the controls stating that, due to the electrostatic ignition hazard, the system is to be used only for fire extinguishing and not for inerting purposes.
- 9.1.2 A high-expansion foam fire-extinguishing system complying with the provisions of the Fire Safety Systems Code, provided that the foam concentrate supply is suitable for extinguishing fires involving the cargoes carried.
- 9.1.3 A fixed pressure water-spraying fire-extinguishing system complying with the provisions of the Fire Safety Systems Code.

9.2 Quantity of fire-extinguishing medium

Where the fire-extinguishing medium used in the cargo pump-room system is also used in systems serving other spaces, the quantity of medium provided or its delivery rate need not be more than the maximum required for the largest compartment.

10 Fire-fighter's outfits

10.1 Types of fire-fighter's outfits

Fire-fighter's outfits shall comply with the Fire Safety Systems Code.

10.2 Number of fire-fighter's outfits

- 10.2.1 Ships shall carry at least two fire-fighter's outfits.
- 10.2.2 In addition, in passenger ships there shall be provided:
 - 10.2.2.1 for every 80 m, or part thereof, of the aggregate of the lengths of all passenger spaces and service spaces on the deck which carries such spaces or, if there is more than one such deck, on the deck which has the largest aggregate of such lengths, two fire-fighter's outfits and, in addition, two sets of personal equipment, each set comprising the items stipulated in the Fire Safety Systems Code. In passenger ships carrying more than 36 passengers, two additional fire-fighter's outfits shall be provided for each main vertical zone. However, for stairway enclosures which constitute individual main vertical zones and for the main vertical zones in the fore or aft end of a ship which do not

contain spaces of categories (6), (7), (8) or (12) defined in regulation 9.2.2.3, no additional firefighter's outfits are required; and

- 10.2.2.2** on ships carrying more than 36 passengers, for each pair of breathing apparatus, one water fog applicator which shall be stored adjacent to such apparatus.
- 10.2.3** In addition, in tankers, two fire-fighter's outfits shall be provided.
- 10.2.4** The Administration may require additional sets of personal equipment and breathing apparatus, having due regard to the size and type of the ship.
- 10.2.5** Two spare charges shall be provided for each required breathing apparatus *containing at least 3,600 l of air*. Passenger ships carrying not more than 36 passengers and cargo ships that are equipped with suitably located means for fully recharging the air cylinders free from contamination need carry only one spare charge for each required apparatus. *The suitable means for fully recharging the air cylinders free from contamination shall consist of at least one air compressor connected to the emergency source of power and with a capacity of 3,600 l times the number of fire-fighter's outfits required; however, the capacity need not exceed 25,000 l*. In passenger ships carrying more than 36 passengers, at least two spare charges for each breathing apparatus shall be provided *in addition to the air compressor mentioned above*.
- 10.2.6** Passenger ships carrying more than 36 passengers constructed on or after 1 July 2010 shall be fitted with a suitably located means for fully recharging breathing air cylinders, free from contamination. The means for recharging shall be either:
 - 10.2.6.1** breathing air compressors supplied from the main and emergency switchboard, or independently driven, with a minimum capacity of 60l/min per required breathing apparatus, not to exceed 420 l/min; or
 - 10.2.6.2** self-contained high-pressure storage systems of suitable pressure to recharge the breathing apparatus used on board, with a capacity of at least 1,200 l per required breathing apparatus, not to exceed 50,000 l of free air.
 - 10.2.6.3** *10.2.6 shall also apply to passenger ships carrying more than 36 passengers, constructed before 1 July 2010.*

10.3 Storage of fire-fighter's outfits

- 10.3.1** The fire-fighter's outfits or sets of personal equipment shall be kept ready for use in an easily accessible location that is permanently and clearly marked and, where more than one fire-fighter's outfit or more than one set of personal equipment is carried, they shall be stored in widely separated positions.
- 10.3.2** In passenger ships, at least two fire-fighter's outfits and, in addition, one set of personal equipment shall be available at any one position. At least two fire-fighter's outfits shall be stored in each main vertical zone.

Regulation 11 – Structural integrity

1 Purpose

The purpose of this regulation is to maintain structural integrity of the ship, preventing partial or whole collapse of the ship structures due to strength deterioration by heat. For this purpose, materials used in the ships' structure shall ensure that the structural integrity is not degraded due to fire.

2 Material of hull, superstructures, structural bulkheads, decks and deckhouses

The hull, superstructures, structural bulkheads, decks and deckhouses shall be constructed of steel or other equivalent material. For the purpose of applying the definition of steel or other equivalent material as given in regulation 3.43, the "applicable fire exposure" shall be according to the integrity and insulation standards given in tables 9.1 to 9.4. For example, where divisions such as decks or sides and ends of deckhouses are permitted to have "B-0" fire integrity, the "applicable fire exposure" shall be half an hour.

3 Structure of aluminium alloy

Unless otherwise specified in paragraph 2, in cases where any part of the structure is of aluminium alloy, the following shall apply:

3.1 the insulation of aluminium alloy components of "A" or "B" class divisions, except structure which, in the opinion of the Administration, is nonload-bearing, shall be such that the temperature of the structural core does not rise more than 200°C above the ambient temperature at any time during the applicable fire exposure to the standard fire test; and

3.2 special attention shall be given to the insulation of aluminium alloy components of columns, stanchions and other structural members required to support lifeboat and liferaft stowage, launching and embarkation areas, and "A" and "B" class divisions to ensure:

3.2.1 that for such members supporting lifeboat and liferaft areas and "A" class divisions, the temperature rise limitation specified in paragraph 3.1 shall apply at the end of one hour; and

3.2.2 that for such members required to support "B" class divisions, the temperature rise limitation specified in paragraph 3.1 shall apply at the end of half an hour.

4 Machinery spaces of category A

4.1 Crowns and casings

Crowns and casings of machinery spaces of category A shall be of steel construction and shall be insulated as required by tables 9.5 and 9.7, as appropriate.

4.2 Floor plating

The floor plating of normal passageways in machinery spaces of category A shall be made of steel.

5 Materials of overboard fittings

Materials readily rendered ineffective by heat shall not be used for overboard scuppers, sanitary discharges, and other outlets which are close to the waterline and where the failure of the material in the event of fire would give rise to danger of flooding.

6 Protection of cargo tank structure against pressure or vacuum in tankers

6.1 General

The venting arrangements shall be so designed and operated as to ensure that neither pressure nor vacuum in cargo tanks shall exceed design parameters and be such as to provide for:

6.1.1 the flow of the small volumes of vapour, air or inert gas mixtures caused by thermal variations in a cargo tank in all cases through pressure/vacuum valves; and

6.1.2 the passage of large volumes of vapour, air or inert gas mixtures during cargo loading and ballasting, or during discharging.

6.2 Openings for small flow by thermal variations

Openings for pressure release required by paragraph 6.1.1 shall:

- 6.2.1 have as great a height as is practicable above the cargo tank deck to obtain maximum dispersal of flammable vapours, but in no case less than 2 m above the cargo tank deck; and
- 6.2.2 be arranged at the furthest distance practicable, but not less than 5 m, from the nearest air intakes and openings to enclosed spaces containing a source of ignition and from deck machinery and equipment which may constitute an ignition hazard. Anchor windlass and chain locker openings constitute an ignition hazard.

6.3 Safety measures in cargo tanks

6.3.1 Preventive measures against liquid rising in the venting system

Provisions shall be made to guard against liquid rising in the venting system to a height which would exceed the design head of cargo tanks. This shall be accomplished by high-level alarms or overflow control systems or other equivalent means, together with independent gauging devices and cargo tank filling procedures. For the purposes of this regulation, spill valves are not considered equivalent to an overflow system.

6.3.2 Secondary means for pressure/vacuum relief

A secondary means of allowing full flow relief of vapour, air or inert gas mixtures shall be provided to prevent over-pressure or under-pressure in the event of failure of the arrangements in paragraph 6.1.2. Alternatively, pressure sensors may be fitted in each tank protected by the arrangement required in paragraph 6.1.2, with a monitoring system in the ship's cargo control room or the position from which cargo operations are normally carried out. Such monitoring equipment shall also provide an alarm facility which is activated by detection of over-pressure or under-pressure conditions within a tank.

6.3.3 Bypasses in vent mains

Pressure/vacuum valves required by paragraph 6.1.1 may be provided with a bypass arrangement when they are located in a vent main or masthead riser. Where such an arrangement is provided there shall be suitable indicators to show whether the bypass is open or closed.

6.3.4 Pressure/vacuum-breaking devices

One or more pressure/vacuum-breaking devices shall be provided to prevent the cargo tanks from being subject to:

- 6.3.4.1 a positive pressure, in excess of the test pressure of the cargo tank, if the cargo were to be loaded at the maximum rated capacity and all other outlets are left shut; and
- 6.3.4.2 a negative pressure in excess of 700 mm water gauge if the cargo were to be discharged at the maximum rated capacity of the cargo pumps and the inert gas blowers were to fail. Such devices shall be installed on the inert gas main unless they are installed in the venting system required by regulation 4.5.3.1 or on individual cargo tanks. The location and design of the devices shall be in accordance with regulation 4.5.3 and paragraph 6.

6.4 Size of vent outlets

Vent outlets for cargo loading, discharging and ballasting required by paragraph 6.1.2 shall be designed on the basis of the maximum designed loading rate multiplied by a factor of at least 1.25 to take account of gas evolution, in order to prevent the pressure in any cargo tank from exceeding the design pressure. The master shall be provided

with information regarding the maximum permissible loading rate for each cargo tank and, in the case of combined venting systems, for each group of cargo tanks.

Notice from the Danish Maritime Authority B – The Construction and Equipment, etc. of Ships

Chapter B II-2 D and E

Construction – Fire protection, fire detection and fire extinction

Regulation 12 – Notification of crew and passengers.....	1
Regulation 13 – Means of escape	1
Regulation 14 – Operational readiness and maintenance	9
Regulation 15 – Instructions, on-board training and drills	10
Regulation 16 – Operations.....	12

Part D – Escape

Regulation 12 – Notification of crew and passengers

1. Purpose

The purpose of this regulation is to notify crew and passengers of a fire for safe evacuation. For this purpose, a general emergency alarm system and a public address system shall be provided.

2. General emergency alarm system

A general emergency alarm system required by regulation III/6.4.2 shall be used for notifying crew and passengers of a fire.

3. Public address systems in passenger ships

A public address system or other effective means of communication complying with the requirements of regulation III/6.5 shall be available throughout the accommodation and service spaces and control stations and open decks.

Regulation 13 – Means of escape

1. Purpose

The purpose of this regulation is to provide means of escape so that persons on board can safely and swiftly escape to the lifeboat and liferaft embarkation deck. For this purpose, the following functional requirements shall be met:

- 1.1. safe escape routes shall be provided;
- 1.2. escape routes shall be maintained in a safe condition, clear of obstacles; and
- 1.3. additional aids for escape shall be provided as necessary to ensure accessibility, clear marking, and adequate design for emergency situations.

2. General requirements

- 2.1. Unless expressly provided otherwise in this regulation, at least two widely separated and ready means of escape shall be provided from all spaces or groups of spaces.
- 2.2. Lifts shall not be considered as forming one of the means of escape as required by this regulation.

3. Means of escape from control stations, accommodation spaces and service spaces

- 3.1. General requirements

- 3.1.1. Stairways and ladders shall be so arranged as to provide ready means of escape to the lifeboat and liferaft embarkation deck from passenger and crew accommodation spaces and from spaces in which the crew is normally employed, other than machinery spaces.
- 3.1.2. Unless expressly provided otherwise in this regulation, a corridor, lobby, or part of a corridor from which there is only one route of escape shall be prohibited. Dead-end corridors used in service areas which are necessary for the practical utility of the ship, such as fuel oil stations and athwartship supply corridors, shall be permitted, provided such dead-end corridors are separated from crew accommodation areas and are inaccessible from passenger accommodation areas. Also, a part of a corridor that has a depth not exceeding its width is considered a recess or local extension and is permitted.
- 3.1.3. All stairways in accommodation and service spaces and control stations shall be of steel frame construction except where the Administration sanctions the use of other equivalent material.
- 3.1.4. If a radiotelegraph station has no direct access to the open deck, two means of escape from, or access to, the station shall be provided, one of which may be a porthole or window of sufficient size or other means to the satisfaction of the Administration.
- 3.1.5. Doors in escape routes shall, in general, open in way of the direction of escape, except that:
 - 3.1.5.1. individual cabin doors may open into the cabins in order to avoid injury to persons in the corridor when the door is opened; and
 - 3.1.5.2. doors in vertical emergency escape trunks may open out of the trunk in order to permit the trunk to be used both for escape and for access.
- 3.2. **Means of escape in passenger ships¹**
 - 3.2.1. Escape from spaces below the bulkhead deck
 - 3.2.1.1. Below the bulkhead deck, two means of escape, at least one of which shall be independent of watertight doors, shall be provided from each watertight compartment or similarly restricted space or group of spaces. Exceptionally, the Administration may dispense with one of the means of escape for crew spaces that are entered only occasionally, if the required escape route is independent of watertight doors.
 - 3.2.1.2. Where the Administration has granted dispensation under the provisions of paragraph 3.2.1.1, this sole means of escape shall provide safe escape. However, stairways shall not be less than 800 mm in clear width with handrails on both sides.
 - 3.2.2. Escape from spaces above the bulkhead deck. Above the bulkhead deck there shall be at least two means of escape from each main vertical zone or similarly restricted space or group of spaces, at least one of which shall give access to a stairway forming a vertical escape.
 - 3.2.3. Direct access to stairway enclosures Stairway enclosures in accommodation and service spaces shall have direct access from the corridors and be of a sufficient area to prevent congestion, having in view the number of persons likely to use them in an emergency. Within the perimeter of such stairway enclosures, only public toilets, lockers of non-combustible material providing storage for non-hazardous safety equipment and open information counters are permitted. Only corridors,

¹ Refer to the Guidelines for evacuation analysis for new and existing passenger ships (MSC.1/Circ.1238).

lifts, public toilets, special category spaces and open ro/ro spaces to which any passengers carried can have access, other escape stairways required by paragraph 3.2.4.1 and external areas are permitted to have direct access to these stairway enclosures. Public spaces may also have direct access to stairway enclosures except for the backstage of a theatre. Small corridors or "lobbies" used to separate an enclosed stairway from galleys or main laundries may have direct access to the stairway provided they have a minimum deck area of 4.5 m², a width of no less than 900 mm and contain a fire hose station.

3.2.4. Details of means of escape

3.2.4.1. At least one of the means of escape required by paragraphs 3.2.1.1 and 3.2.2 shall consist of a readily accessible enclosed stairway, which shall provide continuous fire shelter from the level of its origin to the appropriate lifeboat and liferaft embarkation decks, or to the uppermost weather deck if the embarkation deck does not extend to the main vertical zone being considered. In the latter case, direct access to the embarkation deck by way of external open stairways and passageways shall be provided and shall have emergency lighting in accordance with regulation III/11.5 and slip-free surfaces underfoot. Boundaries facing external open stairways and passageways forming part of an escape route and boundaries in such a position that their failure during a fire would impede escape to the embarkation deck shall have fire integrity, including insulation values, in accordance with tables 9.1 to 9.4, as appropriate.

3.2.4.2. Protection of access from the stairway enclosures to the lifeboat and liferaft embarkation areas shall be provided either directly or through protected internal routes which have fire integrity and insulation values for stairway enclosures as determined by tables 9.1 to 9.4, as appropriate.

3.2.4.3. Stairways serving only a space and a balcony in that space shall not be considered as forming one of the required means of escape.

3.2.4.4. Each level within an atrium shall have two means of escape, one of which shall give direct access to an enclosed vertical means of escape meeting the requirements of paragraph 3.2.4.1.

3.2.4.5. The widths, number and continuity of escapes shall be in accordance with the requirements in the Fire Safety Systems Code.

3.2.5. Marking of escape routes

3.2.5.1. In addition to the emergency lighting required by regulations II-1/42 and III/11.5, the means of escape, including stairways and exits, shall be marked by lighting or photoluminescent strip indicators placed not more than 300 mm above the deck at all points of the escape route, including angles and intersections. The marking must enable passengers to identify the routes of escape and readily identify the escape exits. If electric illumination is used, it shall be supplied by the emergency source of power and it shall be so arranged that the failure of any single light or cut in a lighting strip will not result in the marking being ineffective. Additionally, escape route signs and fire equipment location markings shall be of photoluminescent material or marked by lighting. The Administration shall ensure that such lighting or photoluminescent

equipment has been evaluated, tested and applied in accordance with the Fire Safety Systems Code.

- 3.2.5.2. In passenger ships carrying more than 36 passengers, the requirements of the paragraph 3.2.5.1 shall also apply to the crew accommodation areas.
- 3.2.5.3. In lieu of the escape route lighting system required by paragraph 3.2.5.1, alternative evacuation guidance systems may be accepted if approved by the Administration based on the guidelines developed by the Organization.²
- 3.2.6. Normally locked doors that form part of an escape route
 - 3.2.6.1. Cabin and stateroom doors shall not require keys to unlock them from inside the room. Neither shall there be any doors along any designated escape route which require keys to unlock them when moving in the direction of escape.
 - 3.2.6.2. Escape doors from public spaces that are normally latched shall be fitted with a means of quick release. Such means shall consist of a door-latching mechanism incorporating a device that releases the latch upon the application of a force in the direction of escape flow. Quick release mechanisms shall be designed and installed to the satisfaction of the Administration and, in particular:
 - 3.2.6.2.1. consist of bars or panels, the actuating portion of which extends across at least one half of the width of the door leaf, at least 760 mm and not more than 1,120 mm above the deck;
 - 3.2.6.2.2. cause the latch to release when a force not exceeding 67 N is applied; and
 - 3.2.6.2.3. not be equipped with any locking device, set screw or other arrangement that prevents the release of the latch when pressure is applied to the releasing device.

3.3. Means of escape in cargo ships

- 3.3.1. General
 - At all levels of accommodation there shall be provided at least two widely separated means of escape from each restricted space or group of spaces.
- 3.3.2. Escape from spaces below the lowest open deck
 - Below the lowest open deck the main means of escape shall be a stairway and the second escape may be a trunk or a stairway.
- 3.3.3. Escape from spaces above the lowest open deck.
 - Above the lowest open deck the means of escape shall be stairways or doors to an open deck or a combination thereof.
- 3.3.4. Dead-end corridors. No dead-end corridors having a length of more than 7 m shall be accepted.
- 3.3.5. Width and continuity of escape routes
 - The width, number and continuity of escape routes shall be in accordance with the requirements in the Fire Safety Systems Code.
- 3.3.6. Dispensation from two means of escape

² Refer to the Functional requirements and performance standards for the assessment of evacuation guidance systems (MSC/Circ.1167) and the Interim guidelines for the testing, approval and maintenance of evacuation guidance systems used as an alternative to low-location lighting systems (MSC/Circ.1168).

Exceptionally, the Administration may dispense with one of the means of escape, for crew spaces that are entered only occasionally, if the required escape route is independent of watertight doors.

3.4. Emergency escape breathing devices³

- 3.4.1. Emergency escape breathing devices shall comply with the Fire Safety Systems Code. Spare emergency escape breathing devices shall be kept on board.
- 3.4.2. All ships shall carry at least two emergency escape breathing devices within accommodation spaces.
- 3.4.3. In all passenger ships, at least two emergency escape breathing devices shall be carried in each main vertical zone.
- 3.4.4. In all passenger ships carrying more than 36 passengers, two emergency escape breathing devices, in addition to those required in paragraph 3.4.3 above, shall be carried in each main vertical zone.
- 3.4.5. However, paragraphs 3.4.3 and 3.4.4 do not apply to stairway enclosures which constitute individual main vertical zones and to the main vertical zones in the fore or aft end of a ship which do not contain spaces of categories (6), (7), (8) or (12) as defined in regulation 9.2.2.3.

4. Means of escape from machinery spaces

4.1. Means of escape on passenger ships

Means of escape from each machinery space in passenger ships shall comply with the following provisions.

4.1.1. Escape from spaces below the bulkhead deck

Where the space is below the bulkhead deck, the two means of escape shall consist of either:

- 4.1.1.1. two sets of steel ladders, as widely separated as possible, leading to doors in the upper part of the space, similarly separated and from which access is provided to the appropriate lifeboat and liferaft embarkation decks. One of these ladders shall be located within a protected enclosure that satisfies regulation 9.2.2.3, category (2), or regulation 9.2.2.4, category (4), as appropriate, from the lower part of the space it serves to a safe position outside the space. Self-closing fire doors of the same fire integrity standards shall be fitted in the enclosure. The ladder shall be fixed in such a way that heat is not transferred into the enclosure through non-insulated fixing points. The protected enclosure shall have minimum internal dimensions of at least 800 mm x 800 mm, and shall have emergency lighting provisions; or
- 4.1.1.2. one steel ladder leading to a door in the upper part of the space from which access is provided to the embarkation deck and additionally, in the lower part of the space and in a position well separated from the ladder referred to, a steel door capable of being operated from each side and which provides access to a safe escape route from the lower part of the space to the embarkation deck.

4.1.2. Escape from spaces above the bulkhead deck

Where the space is above the bulkhead deck, the two means of escape shall be as widely separated as possible and the doors leading from such means of escape shall be in a position from which access is provided to the appropriate lifeboat and

³ Refer to the Guidelines for the performance, location, use and care of emergency escape breathing devices (MSC/Circ.849).

liferaft embarkation decks. Where such means of escape require the use of ladders, these shall be of steel.

4.1.3. Dispensation from two means of escape

In a ship of less than 1,000 gross tonnage, the Administration may dispense with one of the means of escape, due regard being paid to the width and disposition of the upper part of the space. In a ship of 1,000 gross tonnage and above, the Administration may dispense with one means of escape from any such space, including a normally unattended auxiliary machinery space, so long as either a door or a steel ladder provides a safe escape route to the embarkation deck, due regard being paid to the nature and location of the space and whether persons are normally employed in that space. In the steering gear space, a second means of escape shall be provided when the emergency steering position is located in that space unless there is direct access to the open deck.

4.1.4. Escape from machinery control rooms

Two means of escape shall be provided from a machinery control room *or a workshop room* located within a machinery space, at least one of which will provide continuous fire shelter to a safe position outside the machinery space.

4.1.5. *Ladders in machinery spaces shall be shielded on the lower side.*

4.2. **Means of escape on cargo ships**

Means of escape from each machinery space in cargo ships shall comply with the following provisions.

4.2.1. Escape from machinery spaces of category A

Except as provided in paragraph 4.2.2, two means of escape shall be provided from each machinery space of category A. In particular, one of the following provisions shall be complied with:

4.2.1.1. two sets of steel ladders, as widely separated as possible, leading to doors in the upper part of the space, similarly separated and from which access is provided to the open deck. One of these ladders shall be located within a protected enclosure that satisfies regulation 9.2.3.3, category (4), from the lower part of the space it serves to a safe position outside the space. Self-closing fire doors of the same fire integrity standards shall be fitted in the enclosure. The ladder shall be fixed in such a way that heat is not transferred into the enclosure through non-insulated fixing points. The enclosure shall have minimum internal dimensions of at least 800 mm x 800 mm, and shall have emergency lighting provisions; or

4.2.1.2. one steel ladder leading to a door in the upper part of the space from which access is provided to the open deck and, additionally, in the lower part of the space and in a position well separated from the ladder referred to, a steel door capable of being operated from each side and which provides access to a safe escape route from the lower part of the space to the open deck.

Machinery control and operation spaces as well as workshop spaces located within a machinery space shall be provided with at least two means of escape, one of which shall be independent of the machinery space and shall allow access to the open deck.

Ladders in machinery spaces shall be made of steel and be shielded on the lower side.

4.2.2. Dispensation from two means of escape

In a ship of less than 1,000 gross tonnage, the Administration may dispense with one of the means of escape required under paragraph 4.2.1, due regard being paid to the dimension and disposition of the upper part of the space. In addition, the means of escape from machinery spaces of category A need not comply with the requirement for an enclosed fire shelter listed in paragraph 4.2.1.1. In the steering gear space, a second means of escape shall be provided when the emergency steering position is located in that space unless there is direct access to the open deck.

- 4.2.3. Escape from machinery spaces other than those of category A
From machinery spaces other than those of category A, two escape routes shall be provided except that a single escape route may be accepted for spaces that are entered only occasionally and for spaces where the maximum travel distance to the door is 5 m or less.

4.3. Emergency escape breathing devices

- 4.3.1. On all ships, within the machinery spaces, emergency escape breathing devices shall be situated ready for use at easily visible places, which can be reached quickly and easily at any time in the event of fire. The location of emergency escape breathing devices shall take into account the layout of the machinery space and the number of persons normally working in the spaces.⁴
- 4.3.2. The number and location of these devices shall be indicated in the fire control plan required in regulation 15.2.4.
- 4.3.3. Emergency escape breathing devices shall comply with the Fire Safety Systems Code.

5. Means of escape on passenger ships from special category and open ro-ro spaces to which any passengers carried can have access

- 5.1. In special category and open ro-ro spaces to which any passengers carried can have access, the number and locations of the means of escape both below and above the bulkhead deck shall be to the satisfaction of the Administration and, in general, the safety of access to the embarkation deck shall be at least equivalent to that provided for under paragraphs 3.2.1.1, 3.2.2, 3.2.4.1 and 3.2.4.2. Such spaces shall be provided with designated walkways to the means of escape with a breadth of at least 600 mm. The parking arrangements for the vehicles shall maintain the walkways clear at all times.
- 5.2. One of the escape routes from the machinery spaces where the crew is normally employed shall avoid direct access to any special category space.

6. Means of escape from ro-ro spaces

At least two means of escape shall be provided in ro-ro spaces where the crew are normally employed. The escape routes shall provide a safe escape to the lifeboat and liferaft embarkation decks and shall be located at the fore and aft ends of the space.

7. Additional requirements for ro-ro passenger ships

7.1. General

- 7.1.1. Escape routes shall be provided from every normally occupied space on the ship to an assembly station. These escape routes shall be arranged so as to provide the

⁴ Refer to the Guidelines for the performance, location, use and care of emergency escape breathing devices (MSC/Circ.849).

most direct route possible to the assembly station⁵, and shall be marked with symbols based on the guidelines developed by the Organization.⁶

- 7.1.2. The escape route from cabins to stairway enclosures shall be as direct as possible, with a minimum number of changes in direction. It shall not be necessary to cross from one side of the ship to the other to reach an escape route. It shall not be necessary to climb more than two decks up or down in order to reach an assembly station or open deck from any passenger space.
 - 7.1.3. External routes shall be provided from open decks, as referred to in paragraph 7.1.2, to the survival craft embarkation stations.
 - 7.1.4. Where enclosed spaces adjoin an open deck, openings from the enclosed space to the open deck shall, where practicable, be capable of being used as an emergency exit.
 - 7.1.5. Escape routes shall not be obstructed by furniture and other obstructions. With the exception of tables and chairs which may be cleared to provide open space, cabinets and other heavy furnishings in public spaces and along escape routes shall be secured in place to prevent shifting if the ship rolls or lists. Floor coverings shall also be secured in place. When the ship is under way, escape routes shall be kept clear of obstructions such as cleaning carts, bedding, luggage and boxes of goods.
- 7.2. Instruction for safe escape**
- 7.2.1. Decks shall be sequentially numbered, starting with "1" at the tank top or lowest deck. The numbers shall be prominently displayed at stair landings and lift lobbies. Decks may also be named, but the deck number shall always be displayed with the name.
 - 7.2.2. Simple "mimic" plans showing the "you are here" position and escape routes marked by arrows shall be prominently displayed on the inside of each cabin door and in public spaces. The plan shall show the directions of escape and shall be properly oriented in relation to its position on the ship.
- 7.3. Strength of handrails and corridors**
- 7.3.1. Handrails or other handholds shall be provided in corridors along the entire escape route so that a firm handhold is available at every step of the way, where possible, to the assembly stations and embarkation stations. Such handrails shall be provided on both sides of longitudinal corridors more than 1.8 m in width and transverse corridors more than 1 m in width. Particular attention shall be paid to the need to be able to cross lobbies, atriums and other large open spaces along escape routes. Handrails and other handholds shall be of such strength as to withstand a distributed horizontal load of 750 N/m applied in the direction of the centre of the corridor or space, and a distributed vertical load of 750N/m applied in the downward direction. The two loads need not be applied simultaneously.⁷
 - 7.3.2. The lowest 0.5 m of bulkheads and other partitions forming vertical divisions along escape routes shall be able to sustain a load of 750 N/m to allow them to be used as walking surfaces from the side of the escape route with the ship at large angles of heel.

⁵ Refer to Indication of the assembly stations in passenger ships (MSC/Circ.777).

⁶ Refer to Symbols related to life-saving appliances and arrangements adopted by the Organization by resolution A.760(18), as amended by resolution MSC.82(70).

⁷ Reference is made to MSC/Circ.910, *Strength of ro-ro passenger ship "B" class bulkheads to which handrails are attached.*

7.4. Evacuation analysis⁸

Escape routes shall be evaluated by an evacuation analysis early in the design process. The analysis shall be used to identify and eliminate, as far as practicable, congestion which may develop during an abandonment, due to normal movement of passengers and crew along escape routes, including the possibility that crew may need to move along these routes in a direction opposite to the movement of passengers. In addition, the analysis shall be used to demonstrate that escape arrangements are sufficiently flexible to provide for the possibility that certain escape routes, assembly stations, embarkation stations or survival craft may not be available as a result of a casualty.

Part E – Operational requirements

Regulation 14 – Operational readiness and maintenance

1. Purpose

The purpose of this regulation is to maintain and monitor the effectiveness of the fire safety measures the ship is provided with. For this purpose, the following functional requirements shall be met:

- 1.1. fire protection systems and fire-fighting systems and appliances shall be maintained ready for use; and
- 1.2. fire protection systems and fire-fighting systems and appliances shall be properly tested and inspected.

2. General requirements

At all times while the ship is in service, the requirements of paragraph 1.1 shall be complied with. A ship is not in service when:

- 2.1. it is in for repairs or lay-up (either at anchor or in port) or in dry-dock;
- 2.2. it is declared not in service by the owner or the owner's representative; and
- 2.3. in the case of passenger ships, there are no passengers on board.

2.1 Operational readiness

2.1.1 The following fire protection systems shall be kept in good order so as to ensure their required performance if a fire occurs:

- 2.1.1.1** Structural fire protection, including fire-resisting divisions, and protection of openings and penetrations in these divisions;
- 2.1.1.2** fire detection and fire alarm systems; and
- 2.1.1.3** means of escape systems and appliances.

2.1.2 Fire-fighting systems and appliances shall be kept in good working order and readily available for immediate use. Portable extinguishers which have been discharged shall be immediately recharged or replaced with an equivalent unit.

2.2 Maintenance, testing and inspections

2.2.1 Maintenance, testing and inspections shall be carried out based on the guidelines developed by the Organization⁹ and in a manner having due regard to ensuring the reliability of fire-fighting systems and appliances.

2.2.2 The maintenance plan shall be kept on board the ship and shall be available for inspection whenever required by the Administration.

2.2.3 The maintenance plan shall include at least the following fire protection systems and fire-fighting systems and appliances, where installed:

⁸ Refer to the Guidelines for a evacuation analysis for new and existing passenger ships (MSC.1/Circ.1238).

⁹ Refer to the Guidelines on maintenance and inspection for fire protection systems and appliances (MSC/Circ.850).

- 2.2.3.1 fire mains, fire pumps and hydrants, including hoses, nozzles and international shore connections;
- 2.2.3.2 fixed fire detection and fire alarm systems;
- 2.2.3.3 fixed fire-extinguishing systems and other fire-extinguishing appliances;
- 2.2.3.4 automatic sprinkler, fire detection and fire alarm systems;
- 2.2.3.5 ventilation systems, including fire and smoke dampers, fans and their controls;
- 2.2.3.6 emergency shutdown of fuel supply;
- 2.2.3.7 fire doors, including their controls;
- 2.2.3.8 general emergency alarm systems;
- 2.2.3.9 emergency escape breathing devices;
- 2.2.3.10 portable fire extinguishers, including spare charges; and
- 2.2.3.11 fire-fighter's outfits.

2.2.4 The maintenance programme may be computer-based.

3. Additional requirements for passenger ships

In addition to the fire protection systems and appliances listed in paragraph 2.2.3, ships carrying more than 36 passengers shall develop a maintenance plan for low-location lighting and public address systems.

4. Additional requirements for tankers

In addition to the fire protection systems and appliances listed in paragraph 2.2.3, tankers shall have a maintenance plan for:

- 4.1. inert gas systems;
- 4.2. deck foam systems;
- 4.3. fire safety arrangements in cargo pumprooms; and
- 4.4. flammable gas detectors.

Regulation 15 – Instructions, on-board training and drills

1. Purpose

The purpose of this regulation is to mitigate the consequences of fire by means of proper instructions for training and drills of persons on board in correct procedures under emergency conditions. For this purpose, the crew shall have the necessary knowledge and skills to handle fire emergency cases, including passenger care.

2. General requirements

2.1. Instructions, duties and organization

- 2.1.1. Crew members shall receive instruction on fire safety on board the ship.
- 2.1.2. Crew members shall receive instructions on their assigned duties.
- 2.1.3. Parties responsible for fire extinguishing shall be organized. These parties shall have the capability to complete their duties at all times while the ship is in service.

2.2. On-board training and drills

- 2.2.1. Crew members shall be trained to be familiar with the arrangements of the ship as well as the location and operation of any fire-fighting systems and appliances that they may be called upon to use.
- 2.2.2. Training in the use of the emergency escape breathing devices shall be considered as part of on board training.
- 2.2.3. Performance of crew members assigned fire-fighting duties shall be periodically evaluated by conducting on-board training and drills to identify areas in need of

improvement, to ensure competency in fire-fighting skills is maintained, and to ensure the operational readiness of the fire-fighting organization.

2.2.4. On-board training in the use of the ship's fire-extinguishing systems and appliances shall be planned and conducted in accordance with the provisions of regulation III/19.4.1.

2.2.5. Fire drills shall be conducted and recorded in accordance with the provisions of regulations III/19.3 and III/19.5.

2.3. Training manuals

2.3.1. A training manual shall be provided in each crew mess room and recreation room or in each crew cabin.

2.3.2. The training manual shall be written in the working language of the ship.

2.3.3. The training manual, which may comprise several volumes, shall contain the instructions and information required in paragraph 2.3.4 in easily understood terms and illustrated wherever possible. Any part of such information may be provided in the form of audiovisual aids in lieu of the manual.

2.3.4. The training manual shall explain the following in detail:

2.3.4.1. general fire safety practice and precautions related to the dangers of smoking, electrical hazards, flammable liquids and similar common shipboard hazards;

2.3.4.2. general instructions on fire-fighting activities and fire-fighting procedures, including procedures for notification of a fire and use of manually operated call points;

2.3.4.3. meanings of the ship's alarms;

2.3.4.4. operation and use of fire-fighting systems and appliances;

2.3.4.5. operation and use of fire doors;

2.3.4.6. operation and use of fire and smoke dampers; and

2.3.4.7. escape systems and appliances.

2.4. Fire control plans¹⁰

2.4.1. General arrangement plans shall be permanently exhibited for the guidance of the ship's officers, showing clearly for each deck the control stations, the various fire sections enclosed by "A" class divisions, the sections enclosed by "B" class divisions together with particulars of the fire detection and fire alarm systems, the sprinkler installation, the fire-extinguishing appliances, means of access to different compartments, decks, etc., and the ventilating system, including particulars of the fan control positions, the position of dampers and identification numbers of the ventilating fans serving each section. Alternatively, at the discretion of the Administration, the aforementioned details may be set out in a booklet, a copy of which shall be supplied to each officer, and one copy shall at all times be available on board in an accessible position. Plans and booklets shall be kept up to date; any alterations thereto shall be recorded as soon as practicable. Description in such plans and booklets shall be in the language or languages required by the Administration. If the language is neither English nor French, a translation into one of those languages shall be included.

2.4.2. A duplicate set of fire control plans or a booklet containing such plans shall be permanently stored in a prominently marked weathertight enclosure outside the deckhouse for the assistance of shore-side fire-fighting personnel.¹¹

¹⁰ Refer to Graphical symbols for fire control plans, adopted by the Organization by resolution A.654(16).

3. Additional requirements for passenger ships

3.1. Fire drills

In addition to the requirement of paragraph 2.2.3, fire drills shall be conducted in accordance with the provisions of regulation III/30, having due regard to notification of passengers and movement of passengers to assembly stations and embarkation decks.

3.2. Fire control plans

In ships carrying more than 36 passengers, plans and booklets required by this regulation shall provide information regarding fire protection, fire detection and fire extinction based on the guidelines developed by the Organization.¹²

Regulation 16 – Operations

1. Purpose

The purpose of this regulation is to provide information and instructions for proper ship and cargo handling operations in relation to fire safety. For this purpose, the following functional requirements shall be met:

- 1.1. fire safety operational booklets shall be provided on board; and
- 1.2. flammable vapour releases from cargo tank venting shall be controlled.

2. Fire safety operational booklets

- 2.1. The required fire safety operational booklet shall contain the necessary information and instructions for the safe operation of the ship and cargo handling operations in relation to fire safety. The booklet shall include information concerning the crew's responsibilities for the general fire safety of the ship while loading and discharging cargo and while under way. Necessary fire safety precautions for handling general cargoes shall be explained. For ships carrying dangerous goods and flammable bulk cargoes, the fire safety operational booklet shall also provide reference to the pertinent fire-fighting and emergency cargo handling instructions contained in the Code of Safe Practice for Solid Bulk Cargoes, the International Bulk Chemical Code, the International Gas Carrier Code and the International Maritime Dangerous Goods Code, as appropriate.
- 2.2. The fire safety operational booklet shall be provided in each crew mess room and recreation room or in each crew cabin.
- 2.3. The fire safety operational booklet shall be written in the working language of the ship.
- 2.4. The fire safety operational booklet may be combined with the training manuals required in regulation 15.2.3.

3. Additional requirements for tankers

3.1. General

The fire safety operational booklet referred to in paragraph 2 shall include provisions for preventing fire spread to the cargo area due to ignition of flammable vapours and include procedures of cargo tank gas-purging and/or gas-freeing, taking into account the provisions in paragraph 3.2.

3.2. Procedures for cargo tank purging and/or gas-freeing

- 3.2.1. When the ship is provided with an inert gas system, the cargo tanks shall first be purged in accordance with the provisions of regulation 4.5.6 until the concentration of hydrocarbon vapours in the cargo tanks has been reduced to less

¹¹ Refer to the Guidance concerning the location of fire control plans for assistance of shoreside fire-fighting personnel (MSC/Circ.451).

¹² Refer to the Guidelines on the information to be provided with fire control plans and booklets required by SOLAS regulations II-2/20 and 41-2, adopted by the Organization by resolution A.756(18).

- than 2% by volume. Thereafter, gas-freeing may take place at the cargo tank deck level.
- 3.2.2. When the ship is not provided with an inert gas system, the operation shall be such that the flammable vapour is discharged initially through:
- 3.2.2.1. the vent outlets as specified in regulation 4.5.3.4;
 - 3.2.2.2. outlets at least 2 m above the cargo tank deck level with a vertical efflux velocity of at least 30 m/s maintained during the gas-freeing operation; or
 - 3.2.2.3. outlets at least 2 m above the cargo tank deck level with a vertical efflux velocity of at least 20 m/s and which are protected by suitable devices to prevent the passage of flame.
- 3.2.3. The above outlets shall be located not less than 10 m, measured horizontally, from the nearest air intakes and openings to enclosed spaces containing a source of ignition and from deck machinery, which may include anchor windlass and chain locker openings, and equipment which may constitute an ignition hazard.
- 3.2.4. When the flammable vapour concentration at the outlet has been reduced to 30% of the lower flammable limit, gas-freeing may be continued at cargo tank deck level.

**Notice from the Danish Maritime Authority B – The
Construction and Equipment, etc. of Ships**

Chapter B II-2 F

Construction – Fire protection, fire detection and fire extinction

Part F – Alternative design and arrangements

Regulation 17 – Alternative design and arrangements

1. Purpose

The purpose of this regulation is to provide a methodology for alternative design and arrangements for fire safety.

2. General

2.1. Fire safety design and arrangements may deviate from the prescriptive requirements set out in parts B, C, D, E or G, provided that the design and arrangements meet the fire safety objectives and the functional requirements.

2.2. When fire safety design or arrangements deviate from the prescriptive requirements of this chapter, engineering analysis, evaluation and approval of the alternative design and arrangements shall be carried out in accordance with this regulation.

3. Engineering analysis

The engineering analysis shall be prepared and submitted to the Administration, based on the guidelines developed by the Organization¹⁾, and shall include, as a minimum, the following elements:

- 3.1. determination of the ship type and space(s) concerned;
- 3.2. identification of prescriptive requirement(s) with which the ship or the space(s) will not comply;
- 3.3. identification of the fire and explosion hazards of the ship or the space(s) concerned, including:
 - 3.3.1. identification of the possible ignition sources;
 - 3.3.2. identification of the fire growth potential of each space concerned;
 - 3.3.3. identification of the smoke and toxic effluent generation potential for each space concerned;
 - 3.3.4. identification of the potential for the spread of fire, smoke or of toxic effluents from the space(s) concerned to other spaces;
- 3.4. determination of the required fire safety performance criteria for the ships or the space(s) concerned addressed by the prescriptive requirement(s), in particular:
 - 3.4.1. performance criteria shall be based on the fire safety objectives and on the functional requirements of this chapter;
 - 3.4.2. performance criteria shall provide a degree of safety not less than that achieved by using the prescriptive requirements; and
 - 3.4.3. performance criteria shall be quantifiable and measurable;
- 3.5. detailed description of the alternative design and arrangements, including a list of the assumptions used in the design and any proposed operational restrictions or conditions; and

¹⁾ Refer to the Guidelines on alternative design and arrangements for fire safety (MSC/Circ.1002).

3.6. technical justification demonstrating that the alternative design and arrangements meet the required fire safety performance criteria.

4. Evaluation of the alternative design and arrangements

4.1. The engineering analysis required in paragraph 3 shall be evaluated and approved by the Administration, taking into account the guidelines developed by the Organization.²⁾

4.2. A copy of the documentation, as approved by the Administration, indicating that the alternative design and arrangements comply with this regulation shall be carried on board the ship.

5. Exchange of information

The Administration shall communicate to the Organization pertinent information concerning alternative design and arrangements approved by them for circulation to all Contracting Governments.

6. Re-evaluation due to change of conditions

If the assumptions, and operational restrictions that were stipulated in the alternative design and arrangements are changed, the engineering analysis shall be carried out under the changed condition and shall be approved by the Administration.

²⁾ Refer to the Guidelines on alternative design and arrangements for fire safety (MSC/Circ.1002).

Notice from the Danish Maritime Authority B – The Construction and Equipment, etc. of Ships

Chapter B II-2 G

Construction – Fire protection, fire detection and fire extinction

Regulation 18 – Helicopter facilities	1
Regulation 19 – Carriage of dangerous goods.....	4
Regulation 20 – Protection of vehicle, special category and ro-ro spaces	11
Regulation 21 – Casualty threshold, safe return to port and safe areas.....	16
Regulation 22 – Design criteria for systems to remain operational after a fire casualty.....	17
Regulation 23 – Safety centre on passenger ships.....	18

Part G – Special requirements

Regulation 18 – Helicopter facilities

1. Purpose

The purpose of this regulation is to provide additional measures in order to address the fire safety objectives of this chapter for ships fitted with special facilities for helicopters. For this purpose, the following functional requirements shall be met:

- 1.1. helideck structure shall be adequate to protect the ship from the fire hazards associated with helicopter operations;
- 1.2. fire-fighting appliances shall be provided to adequately protect the ship from the fire hazards associated with helicopter operations;
- 1.3. refuelling and hangar facilities and operations shall provide the necessary measures to protect the ship from the fire hazards associated with helicopter operations; and
- 1.4. operation manuals and training shall be provided.

2. Application

- 2.1. In addition to complying with the requirements of regulations in parts B, C, D and E, as appropriate, ships equipped with helidecks shall comply with the requirements of this regulation.
- 2.2. Where helicopters land or conduct winching operations on an occasional or emergency basis on ships without helidecks, fire-fighting equipment fitted in accordance with the requirements in part C may be used. This equipment shall be made readily available in close proximity to the landing or winching areas during helicopter operations.
- 2.3. Notwithstanding the requirements of paragraph 2.2 above, ro-ro passenger ships without helidecks shall comply with regulation III/28.

3. Structure

3.1. Construction of steel or other equivalent material

In general, the construction of the helidecks shall be of steel or other equivalent materials. If the helideck forms the deckhead of a deckhouse or superstructure, it shall be insulated to "A-60" class standard.

- 3.2. Construction of aluminium or other low melting point metals

If the Administration permits aluminium or other low melting point metal construction that is not made equivalent to steel, the following provisions shall be satisfied:

- 3.2.1. if the platform is cantilevered over the side of the ship, after each fire on the ship or on the platform, the platform shall undergo a structural analysis to determine its suitability for further use; and
- 3.2.2. if the platform is located above the ship's deckhouse or similar structure, the following conditions shall be satisfied:
 - 3.2.2.1. the deckhouse top and bulkheads under the platform shall have no openings;
 - 3.2.2.2. windows under the platform shall be provided with steel shutters; and
 - 3.2.2.3. after each fire on the platform or in close proximity, the platform shall undergo a structural analysis to determine its suitability for further use.

4. Means of escape

A helideck shall be provided with both a main and an emergency means of escape and access for fire fighting and rescue personnel. These shall be located as far apart from each other as is practicable and preferably on opposite sides of the helideck.

5. Fire-fighting appliances

- 5.1. In close proximity to the helideck, the following fire-fighting appliances shall be provided and stored near the means of access to that helideck:
 - 5.1.1. at least two dry powder extinguishers having a total capacity of not less than 45 kg;¹
 - 5.1.2. carbon dioxide extinguishers of a total capacity of not less than 18 kg or equivalent;
 - 5.1.3. a suitable foam application system consisting of monitors or foam-making branch pipes capable of delivering foam to all parts of the helideck in all weather conditions in which helicopters can operate. The system shall be capable of delivering a discharge rate as required in table 18.1 for at least five minutes;

Table 18.1 – Foam discharge rates

Category	Helicopter overall length	Discharge rate foam solution (l/min)
H1	Up to but not including 15 m	250
H2	From 15 m up to but not including 24 m	500
H3	From 24 m up to but not including 35 m	800

- 5.1.4. the principal agent shall be suitable for use with salt water and conform to performance standards not inferior to those acceptable to the Organization;²
- 5.1.5. at least two nozzles of an approved dual-purpose type (jet/spray) and hoses sufficient to reach any part of the helideck;
- 5.1.6. in addition to the requirements of regulation 10.10, two sets of fire-fighter's outfits; and

¹ Refer to Unified interpretation of SOLAS chapter II-2 on the number and arrangement of portable fire extinguishers on board ships (MSC.1/Circ.1275).

² Refer to the International Civil Aviation Organization Airport Services Manual, part 1, Rescue and Fire Fighting, chapter 8, Extinguishing Agent Characteristics, paragraph 8.1.5, Foam Specifications table 8-1, level "B".

- 5.1.7. at least the following equipment shall be stored in a manner that provides for immediate use and protection from the elements:
 - 5.1.7.1. adjustable wrench;
 - 5.1.7.2. blanket, fire-resistant;
 - 5.1.7.3. cutters, bolt, 60 cm;
 - 5.1.7.4. hook, grab or salving;
 - 5.1.7.5. hacksaw, heavy duty complete with 6 spare blades;
 - 5.1.7.6. ladder;
 - 5.1.7.7. lift line 5 mm diameter and 15 m in length;
 - 5.1.7.8. pliers, side-cutting;
 - 5.1.7.9. a set of assorted screwdrivers; and
 - 5.1.7.10. harness knife complete with sheath.

6. Drainage facilities

Drainage facilities in way of helidecks shall be constructed of steel and shall lead directly overboard independent of any other system and shall be designed so that drainage does not fall onto any part of the ship.

7. Helicopter refuelling and hangar facilities

Where the ship has helicopter refuelling and hangar facilities, the following requirements shall be complied with:

- 7.1. a designated area shall be provided for the storage of fuel tanks which shall be:
 - 7.1.1. as remote as is practicable from accommodation spaces, escape routes and embarkation stations; and
 - 7.1.2. isolated from areas containing a source of vapour ignition;
- 7.2. the fuel storage area shall be provided with arrangements whereby fuel spillage may be collected and drained to a safe location;
- 7.3. tanks and associated equipment shall be protected against physical damage and from a fire in an adjacent space or area;
- 7.4. where portable fuel storage tanks are used, special attention shall be given to:
 - 7.4.1. design of the tank for its intended purpose;
 - 7.4.2. mounting and securing arrangements;
 - 7.4.3. electric bonding; and
 - 7.4.4. inspection procedures;
- 7.5. storage tank fuel pumps shall be provided with means which permit shutdown from a safe remote location in the event of a fire. Where a gravity fuelling system is installed, equivalent closing arrangements shall be provided to isolate the fuel source;
- 7.6. the fuel pumping unit shall be connected to one tank at a time. The piping between the tank and the pumping unit shall be of steel or equivalent material, as short as possible, and protected against damage;
- 7.7. electrical fuel pumping units and associated control equipment shall be of a type suitable for the location and potential hazards;
- 7.8. fuel pumping units shall incorporate a device which will prevent over-pressurization of the delivery or filling hose;
- 7.9. equipment used in refuelling operations shall be electrically bonded;
- 7.10. "NO SMOKING" signs shall be displayed at appropriate locations;
- 7.11. hangar, refuelling and maintenance facilities shall be treated as category A machinery spaces with regard to structural fire protection, fixed fire-extinguishing and detection system requirements;
- 7.12. enclosed hangar facilities or enclosed spaces containing refuelling installations shall be provided with mechanical ventilation, as required by

regulation 20.3 for closed ro-ro spaces of cargo ships. Ventilation fans shall be of non-sparking type; and

- 7.13. electric equipment and wiring in enclosed hangars or enclosed spaces containing refuelling installations shall comply with regulations 20.3.2, 20.3.3 and 20.3.4.

8. Operations manual and fire-fighting arrangements

- 8.1. Each helicopter facility shall have an operations manual, including a description and a checklist of safety precautions, procedures and equipment requirements. This manual may be part of the ship's emergency response procedures.
- 8.2. The procedures and precautions to be followed during refuelling operations shall be in accordance with recognized safe practices and contained in the operations manual.
- 8.3. Fire-fighting personnel, consisting of at least two persons trained for rescue and fire-fighting duties, and fire-fighting equipment shall be immediately available at all times when helicopter operations are expected.
- 8.4. Fire-fighting personnel shall be present during refuelling operations. However, the fire-fighting personnel shall not be involved with refuelling activities.
- 8.5. On-board refresher training shall be carried out and additional supplies of fire-fighting media shall be provided for training and testing of the equipment.

Regulation 19 – Carriage of dangerous goods³

1. Purpose

The purpose of this regulation is to provide additional safety measures in order to address the fire safety objectives of this chapter for ships carrying dangerous goods. For this purpose, the following functional requirements shall be met:

- 1.1. fire protection systems shall be provided to protect the ship from the added fire hazards associated with carriage of dangerous goods;
- 1.2. dangerous goods shall be adequately separated from ignition sources; and
- 1.3. appropriate personnel protective equipment shall be provided for the hazards associated with the carriage of dangerous goods.

2. General requirements

- 2.1. In addition to complying with the requirements of regulations in parts B, C, D, E and regulations 18 and 20,⁴ as appropriate, ship types and cargo spaces, referred to in paragraph 2.2, intended for the carriage of dangerous goods shall comply with the requirements of this regulation, as appropriate, except when carrying dangerous goods in limited quantities and excepted quantities⁵ unless such requirements have already been met by compliance with the requirements elsewhere in this chapter. The types of ships and modes of carriage of dangerous goods are referred to in paragraph 2.2 and in table 19.1. Cargo ships of less than 500 gross tonnage shall comply with this regulation, but Administrations may reduce the requirements and such reduced requirements shall be recorded in the document of compliance referred to in paragraph 4.
- 2.2. The following ship types and cargo spaces shall govern the application of tables 19.1 and 19.2:

³ Refer to the Interim guidelines for open-top container ships, MSC/Circ.608/Rev.1.

⁴ Refer to part 7 of the International Maritime Dangerous Goods Code.

⁵ Refer to chapter 3.5 of the IMDG Code.

- 2.2.1. ships and cargo spaces not specifically designed for the carriage of freight containers, but intended for the carriage of dangerous goods in packaged form, including goods in freight containers and portable tanks;
- 2.2.2. purpose-built containerships and cargo spaces intended for the carriage of dangerous goods in freight containers and portable tanks;
- 2.2.3. ro-ro ships and ro-ro spaces intended for the carriage of dangerous goods;
- 2.2.4. ships and cargo spaces intended for the carriage of solid dangerous goods in bulk; and
- 2.2.5. ships and cargo spaces intended for carriage of dangerous goods other than liquids and gases in bulk in shipborne barges.

3. Special requirements

Unless otherwise specified, the following requirements shall govern the application of tables 19.1, 19.2 and 19.3 to both "on-deck" and "underdeck" stowage of dangerous goods where the numbers of the following paragraphs are indicated in the first column of the tables.

3.1. Water supplies

- 3.1.1. Arrangements shall be made to ensure immediate availability of a supply of water from the fire main at the required pressure either by permanent pressurization or by suitably placed remote arrangements for the fire pumps.
- 3.1.2. The quantity of water delivered shall be capable of supplying four nozzles of a size and at pressures as specified in regulation 10.2, capable of being trained on any part of the cargo space when empty. This amount of water may be applied by equivalent means to the satisfaction of the Administration.
- 3.1.3. Means shall be provided for effectively cooling the designated under-deck cargo space by at least 5 l/ min per square metre of the horizontal area of cargo spaces, either by a fixed arrangement of spraying nozzles or by flooding the cargo space with water. Hoses may be used for this purpose in small cargo spaces and in small areas of larger cargo spaces at the discretion of the Administration. However, the drainage and pumping arrangements shall be such as to prevent the build-up of free surfaces. The drainage system shall be sized to remove no less than 125% of the combined capacity of both the water spraying system pumps and the required number of fire hose nozzles. The drainage system valves shall be operable from outside the protected space at a position in the vicinity of the extinguishing system controls. Bilge wells shall be of sufficient holding capacity and shall be arranged at the side shell of the ship at a distance from each other of not more than 40 m in each watertight compartment. If this is not possible, the adverse effect upon stability of the added weight and free surface of water shall be taken into account to the extent deemed necessary by the Administration in its approval of the stability information.⁶
- 3.1.4. Provision to flood a designated under-deck cargo space with suitable specified media may be substituted for the requirements in paragraph 3.1.3.

⁶ Refer to the Recommendation on fixed fire-extinguishing systems for special category spaces adopted by the Organization by resolution A.123(V).

- 3.1.5. The total required capacity of the water supply shall satisfy paragraphs 3.1.2 and 3.1.3, if applicable, simultaneously calculated for the largest designated cargo space. The capacity requirements of paragraph 3.1.2 shall be met by the total capacity of the main fire pump(s), not including the capacity of the emergency fire pump, if fitted. If a drencher system is used to satisfy paragraph 3.1.3, the drencher pump shall also be taken into account in this total capacity calculation.
- 3.2. **Sources of ignition**
Electrical equipment and wiring shall not be fitted in enclosed cargo spaces or vehicle spaces unless it is essential for operational purposes in the opinion of the Administration. However, if electrical equipment is fitted in such spaces, it shall be of a certified safe type⁷ for use in the dangerous environments to which it may be exposed unless it is possible to completely isolate the electrical system (e.g. by removal of links in the system, other than fuses). Cable penetrations of the decks and bulkheads shall be sealed against the passage of gas or vapour. Through runs of cables and cables within the cargo spaces shall be protected against damage from impact. Any other equipment which may constitute a source of ignition of flammable vapour shall not be permitted.
- 3.3. **Detection system**
Ro-ro spaces shall be fitted with a fixed fire detection and fire alarm system complying with the requirements of the Fire Safety Systems Code. All other types of cargo spaces shall be fitted with either a fixed fire detection and fire alarm system or a sample extraction smoke detection system complying with the requirements of the Fire Safety Systems Code. If a sample extraction smoke detection system is fitted, particular attention shall be given to paragraph 2.1.3 in chapter 10 of the Fire Safety Systems Code in order to prevent the leakage of toxic fumes into occupied areas.
- 3.4. **Ventilation arrangement**
- 3.4.1. Adequate power ventilation shall be provided in enclosed cargo spaces. The arrangement shall be such as to provide for at least six air changes per hour in the cargo space, based on an empty cargo space, and for removal of vapours from the upper or lower parts of the cargo space, as appropriate.
- 3.4.2. The fans shall be such as to avoid the possibility of ignition of flammable gas/air mixtures. Suitable wire mesh guards shall be fitted over inlet and outlet ventilation openings.
- 3.4.3. Natural ventilation shall be provided in enclosed cargo spaces intended for the carriage of solid dangerous goods in bulk, where there is no provision for mechanical ventilation.
- 3.5. **Bilge pumping**
- 3.5.1. Where it is intended to carry flammable or toxic liquids in enclosed cargo spaces, the bilge pumping system shall be designed to protect against inadvertent pumping of such liquids through machinery space piping or pumps. Where large quantities of such liquids are carried, consideration shall be given to the provision of additional means of draining those cargo spaces.
- 3.5.2. If the bilge drainage system is additional to the system served by pumps in the machinery space, the capacity of the system shall be not

⁷ Refer to the Recommendations of the International Electrotechnical Commission, in particular publication IEC 60092, Electrical installations in ships.

less than 10 m³/h per cargo space served. If the additional system is common, the capacity need not exceed 25 m³/h. The additional bilge system need not be arranged with redundancy.

- 3.5.3. Whenever flammable or toxic liquids are carried, the bilge line into the machinery space shall be isolated either by fitting a blank flange or by a closed lockable valve.
- 3.5.4. Enclosed spaces outside machinery spaces containing bilge pumps serving cargo spaces intended for carriage of flammable or toxic liquids shall be fitted with separate mechanical ventilation giving at least six air changes per hour. If the space has access from another enclosed space, the door shall be self-closing.
- 3.5.5. If bilge drainage of cargo spaces is arranged by gravity drainage, the drainage shall be either led directly overboard or to a closed drain tank located outside the machinery spaces. The tank shall be provided with a vent pipe to a safe location on the open deck. Drainage from a cargo space into bilge wells in a lower space is only permitted if that space satisfies the same requirements as the cargo space above.

3.6. **Personnel protection**

- 3.6.1. Four sets of full protective clothing, resistant to chemical attack, shall be provided in addition to the fire-fighter's outfits required by regulation 10.10 and shall be selected taking into account the hazards associated with the chemicals being transported and the standards developed by the Organization according to the class and physical state.⁸ The protective clothing shall cover all skin, so that no part of the body is unprotected.
- 3.6.2. At least two self-contained breathing apparatuses additional to those required by regulation 10.10 shall be provided. Two spare charges suitable for use with the breathing apparatus shall be provided for each required apparatus. Passenger ships carrying not more than 36 passengers and cargo ships that are equipped with suitably located means for fully recharging the air cylinders free from contamination need carry only one spare charge for each required apparatus.
- 3.6.3. *For cargo ships with a gross tonnage below 500, the extent of this equipment will be assessed in each individual case.*

3.7. **Portable fire extinguishers**

Portable fire extinguishers with a total capacity of at least 12 kg of dry powder or equivalent shall be provided for the cargo spaces. These extinguishers shall be in addition to any portable fire extinguishers required elsewhere in this chapter.

3.8. **Insulation of machinery space boundaries**

Bulkheads forming boundaries between cargo spaces and machinery spaces of category A shall be insulated to "A-60" class standard⁹, unless the dangerous goods are stowed at least 3 m horizontally away from such bulkheads. Other boundaries between such spaces shall be insulated to "A-60" class standard.

3.9. **Water-spray system (*Car deck sprinkler system*)**

⁸ For solid bulk cargoes, the protective clothing should satisfy the equipment provisions specified in the respective schedules of the IMSBC Code for the individual substances. For packaged goods, the protective clothing should satisfy the equipment provisions specified in emergency procedures (EmS) of the Supplement to the IMDG Code for the individual substances.

⁹ For container ships, see the table in paragraph 19.1.

Each open ro-ro space having a deck above it and each space deemed to be a closed ro-ro space not capable of being sealed shall be fitted with an approved fixed pressure water-spraying system for manual operation which shall protect all parts of any deck and vehicle platform in the space, except that the Administration may permit the use of any other fixed fire-extinguishing system that has been shown by full-scale test to be no less effective. However, the drainage and pumping arrangements shall be such as to prevent the build-up of free surfaces. The drainage system shall be sized to remove no less than 125% of the combined capacity of both the water-spraying system pumps and the required number of fire hose nozzles. The drainage system valves shall be operable from outside the protected space at a position in the vicinity of the extinguishing system controls. Bilge wells shall be of sufficient holding capacity and shall be arranged at the side shell of the ship at a distance from each other of not more than 40 m in each watertight compartment. If this is not possible, the adverse effect upon stability of the added weight and free surface of water shall be taken into account to the extent deemed necessary by the Administration in its approval of the stability information.¹⁰

3.10. Separation of ro-ro spaces

3.10.1. In ships having ro-ro spaces, a separation shall be provided between a closed ro-ro space and an adjacent open ro-ro space. The separation shall be such as to minimize the passage of dangerous vapours and liquids between such spaces. Alternatively, such separation need not be provided if the ro-ro space is considered to be a closed cargo space over its entire length and fully complies with the relevant special requirements of this regulation.

3.10.2. In ships having ro-ro spaces, a separation shall be provided between a closed ro-ro space and the adjacent weather deck. The separation shall be such as to minimize the passage of dangerous vapours and liquids between such spaces. Alternatively, a separation need not be provided if the arrangements of the closed ro-ro spaces are in accordance with those required for the dangerous goods carried on adjacent weather decks.

4. Document of compliance¹¹

The Administration shall provide the ship with an appropriate document as evidence of compliance of construction and equipment with the requirements of this regulation. Certification for dangerous goods, except solid dangerous goods in bulk, is not required for those cargoes specified as class 6.2 and 7 and dangerous goods in limited quantities and excepted quantities.

¹⁰ Refer to the Recommendation on fixed fire-extinguishing systems for special category spaces adopted by the Organization by resolution A.123(V).

¹¹ Refer to the Document of Compliance with the special requirements for ships carrying dangerous goods under the provisions of regulation II-2/54 of SOLAS 74, as amended (MSC/Circ.642).

Table 19.1 – Application of the requirements to different modes of carriage of dangerous goods in ships and cargo spaces

Where X appears in table 19.1, it means this requirement is applicable to all classes of dangerous goods as given in the appropriate line of table 19.3, except as indicated by the notes.

Regulation 19.2.2 →	Weather decks (.1 to .5 inclusive)	.1 Not specifically designed	.2 Container cargo spaces	.3		.4 Solid dangerous goods in bulk	.5 Shippable barges
Regulation 19 ↓				Closed ro-ro spaces ³	Open ro-ro spaces		
.3.1.1	X	X	X	X	X	For application of requirements of regulation 19 to different classes of dangerous goods, see table 19.2	X
.3.1.2	X	X	X	X	X		-
.3.1.3	-	X	X	X	X		X
.3.1.4	-	X	X	X	X		X
.3.2	-	X	X	X	X		X ⁴
.3.3	-	X	X	X	-		X ⁴
.3.4.1	-	X	X ¹	X	-		X ⁴
.3.4.2	-	X	X ¹	X	-		X ⁴
.3.5	-	X	X	X	-		-
.3.6.1	X	X	X	X	X		-
.3.6.2	X	X	X	X	X		-
.3.7	X	X	-	-	X		-
.3.8	X	X	X ²	X	X		-
.3.9	-	-	-	X ³	X		-
.3.10.1	-	-	-	X	-		-
.3.10.2	-	-	-	X	-	-	

Notes:

- For classes 4 and 5.1 not applicable to closed freight containers.
For classes 2, 3, 6.1 and 8 when carried in closed freight containers, the ventilation rate may be reduced to not less than two air changes. For the purpose of this requirement a portable tank is a closed freight container.
- Applicable to decks only.
- Applies only to closed ro-ro spaces, not capable of being sealed.
- In the special case where the barges are capable of containing flammable vapours or alternatively if they are capable of discharging flammable vapours to a safe space outside the barge carrier compartment by means of ventilation ducts connected to the barges, these requirements may be reduced or waived to the satisfaction of the Administration.
- Special category spaces shall be treated as closed ro-ro spaces when dangerous goods are carried.

Table 19.2 – Application of the requirements to different classes of dangerous goods for ships and cargo spaces carrying solid dangerous goods in bulk

Regulation 19	Class	4.1	4.2	4.3 ⁶	5.1	6.1	8	9
.3.1.1		X	x	-	x	-	-	x
.3.1.2		X	x	-	x	-	-	x
.3.2		X	x ⁷	x	x ⁸	-	-	x ⁸
.3.4.1		-	x ⁷	x	-	-	-	-
.3.4.2		x ⁹	x ⁷	x	x ^{7,9}	-	-	x ^{7,9}
.3.4.3		X	x	x	x	x	x	x
.3.6		X	x	x	x	x	x	x
.3.8		X	x	x	x ⁷	-	-	x ¹⁰

Notes:

- The hazards of substances in this class which may be carried in bulk are such that special consideration shall be given by the Administration to the construction and equipment of the ship involved in addition to meeting the requirements enumerated in this table.
- Only applicable to Seedcake containing solvent extractions, to Ammonium nitrate and to Ammonium nitrate fertilizers.
- Only applicable to Ammonium nitrate and to Ammonium nitrate fertilizers. However, a degree of protection in accordance with standards contained in the International Electrotechnical Commission publication 60079, "Electrical apparatus for explosive gas atmospheres", is sufficient.
- Only suitable wire mesh guards are required.
- The requirements of the Code of Safe Practice for Solid Bulk Cargoes, adopted by resolution A.434(XI), as amended, are sufficient.

Table 19.3 – Application of the requirements to different classes of dangerous goods except solid dangerous goods in bulk

Class →	1.1- 1.6	1.4S	2.1	2.2	2.3	3 Liquids ≤ 23°C ¹⁵	3 liquids >23°C ¹⁵ ≤ 61°C	4.1	4.2	4.3	5.1	5.2	6.1 liquids	6.1 ≤23°C ¹⁵	6.1 liquids >23°C ¹⁵ ≤61°C	6.1 solids	8 liquids	8 liquids ≤23°C ¹⁵	8 liquids >23°C ¹⁵ ≤61°C	8 solids	9
Regulation 19 ↓																					
.3.1.1	X	X	X	X	X	X	X	X	X	X	X	X	X	X	X	X	X	X	X	X	X
.3.1.2	X	X	X	X	X	X	X	X	X	X	X	X	X	X	X	X	X	X	X	X	-
.3.1.3	X	-	-	-	-	-	-	-	-	-	-	-	-	-	-	-	-	-	-	-	-
.3.1.4	X	-	-	-	-	-	-	-	-	-	-	-	-	-	-	-	-	-	-	-	-
.3.2	X	-	X	-	-	X	-	-	-	-	-	-	-	X	-	-	-	X	-	-	-
.3.3	X	X	X	X	X	X	X	X	X	X	X	-	X	X	X	X	X	X	X	X	-
.3.4.1	-	-	X	-	X	X	-	X ¹¹	X ¹¹	X	X ¹¹	-	-	X	X	X ¹¹	-	X	X	-	X ¹¹
.3.4.2	-	-	X	-	-	X	-	-	-	-	-	-	-	X	X	-	-	X	X	-	-
.3.5	-	-	-	-	-	X	-	-	-	-	-	-	X	X	X	-	-	X	-	-	-
.3.6	-	-	X	X	X	X	X	X	X	X	X	X	X	X	X	X	X	X	X	X	X ¹⁴
.3.7	-	-	-	-	-	X	X	X	X	X	X	-	-	X	X	-	-	X	X	-	-
.3.8	X ¹²	-	X	X	X	X	X	X	X	X	X ¹³	-	-	X	X	-	-	X	X	-	-
.3.9	X	X	X	X	X	X	X	X	X	X	X	X	X	X	X	X	X	X	X	X	X
.3.10.1	X	X	X	X	X	X	X	X	X	X	X	X ¹⁶	X	X	X	X	X	X	X	X	X
.3.10.2	X	X	X	X	X	X	X	X	X	X	X	X ¹⁶	X	X	X	X	X	X	X	X	X

Notes:

¹¹ When "mechanically-ventilated spaces" are required by the International Maritime Dangerous Goods Code, as amended.

¹² Stow 3 m horizontally away from the machinery space boundaries in all cases.

¹³ Refer to the International Maritime Dangerous Goods Code, as amended.

¹⁴ As appropriate to the goods to be carried.

¹⁵ Refers to flashpoint.

¹⁶ Under the provisions of the IMDG Code, as amended, stowage of class 5.2 dangerous goods under deck or in enclosed ro-ro spaces is prohibited.

Regulation 20 – Protection of vehicle, special category and ro-ro spaces

1. Purpose

The purpose of this regulation is to provide additional safety measures in order to address the fire safety objectives of this chapter for ships fitted with vehicle, special category and ro-ro spaces. For this purpose, the following functional requirements shall be met:

- 1.1. fire protection systems shall be provided to adequately protect the ship from the fire hazards associated with vehicle, special category and ro-ro spaces;
- 1.2. ignition sources shall be separated from vehicle, special category and ro-ro spaces; and
- 1.3. vehicle, special category and ro-ro spaces shall be adequately ventilated.

2. General requirements

2.1. Application

In addition to complying with the requirements of regulations in parts B, C, D and E, as appropriate, vehicle, special category and ro-ro spaces shall comply with the requirements of this regulation.

2.2. Basic principles for passenger ships

- 2.2.1. The basic principle underlying the provisions of this regulation is that the main vertical zoning required by regulation 9.2 may not be practicable in vehicle spaces of passenger ships and, therefore, equivalent protection must be obtained in such spaces on the basis of a horizontal zone concept and by the provision of an efficient fixed fire-extinguishing system. Based on this concept, a horizontal zone for the purpose of this regulation may include special category spaces on more than one deck provided that the total overall clear height for vehicles does not exceed 10 m.
- 2.2.2. The basic principle underlying the provisions of paragraph 2.2.1 is also applicable to ro-ro spaces.
- 2.2.3. The requirements of ventilation systems, openings in "A" class divisions and penetrations in "A" class divisions for maintaining the integrity of vertical zones in this chapter shall be applied equally to decks and bulkheads forming the boundaries separating horizontal zones from each other and from the remainder of the ship.

3. Precaution against ignition of flammable vapours in closed vehicle spaces, closed ro-ro spaces and special category spaces

3.1. Ventilation systems

3.1.1. Capacity of ventilation systems

There shall be provided an effective power ventilation system sufficient to give at least the following air changes:

.1 Passenger ships:

Special category spaces 10 air changes per hour

Closed ro-ro and vehicle spaces
other than special category spaces

for ships carrying more than 36 passengers 10 air changes per hour

Closed ro-ro and vehicle spaces
other than special category spaces

for ships carrying not more than 36 passenger 6 air changes per hour

.2 Cargo ships:

6 air changes per hour

The Administration may require an increased number of air changes when vehicles are being loaded and unloaded.¹²

3.1.2. Performance of ventilation systems

3.1.2.1. In passenger ships, the power ventilation system required in paragraph 3.1 shall be separate from other ventilation systems and shall be in operation at all times when vehicles are in such spaces. Ventilation ducts serving such cargo spaces capable of being effectively sealed shall be separated for each such space. The system shall be capable of being controlled from a position outside such spaces.

3.1.2.2. In cargo ships, ventilation fans shall normally be run continuously whenever vehicles are on board. Where this is impracticable, they shall be operated for a limited period daily as weather permits and in any case for a reasonable period prior to discharge, after which period the ro-ro or vehicle space shall be proved gas-free. One or more portable combustible gas detecting instruments shall be carried for this purpose. The system shall be entirely separate from other ventilating systems. Ventilation ducts serving ro-ro or vehicle spaces shall be capable of being effectively sealed for each cargo space. The system shall be capable of being controlled from a position outside such spaces.

3.1.2.3. The ventilation system shall be such as to prevent air stratification and the formation of air pockets.

3.1.3. Indication of ventilation systems

Means shall be provided on the navigation bridge to indicate any loss of the required ventilating capacity.

3.1.4. Closing appliances and ducts

3.1.4.1. Arrangements shall be provided to permit a rapid shutdown and effective closure of the ventilation system from outside of the space in case of fire, taking into account the weather and sea conditions.

3.1.4.2. Ventilation ducts, including dampers, within a common horizontal zone shall be made of steel. In passenger ships, ventilation ducts that pass through other horizontal zones or machinery spaces shall be "A-60" class steel ducts constructed in accordance with regulations 9.7.2.1.1 and 9.7.2.1.2.

3.1.5. Permanent openings

Permanent openings in the side plating, the ends or deckhead of the space shall be so situated that a fire in the cargo space does not endanger stowage areas and embarkation stations for survival craft and accommodation spaces, service spaces and control stations in superstructures and deckhouses above the cargo spaces.

3.2. **Electrical equipment and wiring**

3.2.1. Except as provided in paragraph 3.2.2, electrical equipment and wiring shall be of a type suitable for use in an explosive petrol and air mixture.¹³

¹² Reference is made to MSC/Circ.729, Recommendation on constructional and operational guidelines for ventilation system in ro-ro spaces as well as to DS/EN ISO 9785, Ventilation of cargo spaces for cars with combustion engine – Calculation of theoretical quantity of air

As to the inspection of the degree of purity of air, reference is made to Notice A from the Danish Maritime Authority, technical regulation on occupational health on board ships (Limit values for substances and materials).

¹³ Refer to the recommendations of the International Electrotechnical Commission, in particular publication 60079.

3.2.2. In case of other than special category spaces below the bulkhead deck, notwithstanding the provisions in paragraph 3.2.1, above a height of 450 mm from the deck and from each platform for vehicles, if fitted, except platforms with openings of sufficient size permitting penetration of petrol gases downwards, electrical equipment of a type so enclosed and protected as to prevent the escape of sparks shall be permitted as an alternative, on condition that the ventilation system is so designed and operated as to provide continuous ventilation of the cargo spaces at the rate of at least ten air changes per hour whenever vehicles are on board.

3.3. Electrical equipment and wiring in exhaust ventilation ducts

Electrical equipment and wiring, if installed in an exhaust ventilation duct, shall be of a type approved for use in explosive petrol and air mixtures and the outlet from any exhaust duct shall be sited in a safe position, having regard to other possible sources of ignition.

3.4. Other ignition sources

Other equipment which may constitute a source of ignition of flammable vapours shall not be permitted.

3.5. Scuppers and discharges

Scuppers shall not be led to machinery or other spaces where sources of ignition may be present.

4. Detection and alarm

4.1. Fixed fire detection and fire alarm systems

Except as provided in paragraph 4.3.1, there shall be provided a fixed fire detection and fire alarm system complying with the requirements of the Fire Safety Systems Code. The fixed fire detection system shall be capable of rapidly detecting the onset of fire. The type of detectors and their spacing and location shall be to the satisfaction of the Administration, taking into account the effects of ventilation and other relevant factors. After being installed, the system shall be tested under normal ventilation conditions and shall give an overall response time to the satisfaction of the Administration.

4.2. Sample extraction smoke detection systems

Except open ro-ro spaces, open vehicle spaces and special category spaces, a sample extraction smoke detection system complying with the requirements of the Fire Safety Systems Code may be used as an alternative for the fixed fire detection and fire alarm system required in paragraph 4.1.

4.3. Special category spaces

4.3.1. An efficient fire patrol system shall be maintained in special category spaces. If an efficient fire patrol system is maintained by a continuous fire watch at all times during the voyage, a fixed fire detection and fire alarm system is not required.

4.3.2. Manually operated call points shall be spaced so that no part of the space is more than 20 m from a manually operated call point, and one shall be placed close to each exit from such spaces.

5. Structural fire protection

Notwithstanding the provisions of regulation 9.2.2, in passenger ships carrying more than 36 passengers, the boundary bulkheads and decks of special category spaces and ro-ro spaces shall be insulated to "A-60" class standard. However, where a category (5), (9) or (10) space, as defined in regulation 9.2.2.3, is on one side of the division, the standard may be reduced to "A-0". Where fuel oil tanks are below a special category space or a ro-ro space, the integrity of the deck between such spaces may be reduced to "A-0" standard.

6. Fire extinction

6.1. Fixed fire-extinguishing systems¹⁴

- 6.1.1. Vehicle spaces and ro-ro spaces which are not special category spaces and are capable of being sealed from a location outside of the cargo spaces shall be fitted with a fixed gas fire-extinguishing system which shall comply with the provisions of the Fire Safety Systems Code, except that:
- 6.1.1.1. if a carbon dioxide fire-extinguishing system is fitted, the quantity of gas available shall be at least sufficient to give a minimum volume of free gas equal to 45% of the gross volume of the largest such cargo space which is capable of being sealed, and the arrangements shall be such as to ensure that at least two thirds of the gas required for the relevant space shall be introduced within 10 min;
 - 6.1.1.2. any other fixed inert gas fire-extinguishing system or fixed high-expansion foam fire-extinguishing system may be fitted provided the Administration is satisfied that an equivalent protection is achieved; and
 - 6.1.1.3. as an alternative, a fire-extinguishing system meeting the requirements of paragraph 6.1.2 may be fitted.
- 6.1.2. Ro-ro and vehicle spaces not capable of being sealed and special category spaces shall be fitted with an approved fixed pressure water-spraying system¹⁵ for manual operation which shall protect all parts of any deck and vehicle platform in such spaces. Such water spray systems shall have:
- 6.1.2.1. a pressure gauge on the valve manifold;
 - 6.1.2.2. clear marking on each manifold valve indicating the spaces served;
 - 6.1.2.3. instructions for maintenance and operation located in the valve room; and
 - 6.1.2.4. a sufficient number of drainage valves.
- 6.1.3. The Administration may permit the use of any other fixed fire-extinguishing system¹⁶ that has been shown, by a full-scale test in conditions simulating a flowing petrol fire in a vehicle space or a ro-ro space, to be not less effective in controlling fires likely to occur in such a space.
- 6.1.4. The requirements of this paragraph shall apply to ships constructed on or after 1 January 2010. Ships constructed on or after 1 July 2002 and before 1 January 2010 shall comply with the previously applicable requirements of paragraph 6.1.4, as amended by resolution MSC.99(73). When fixed pressure water-spraying systems are fitted, in view of the serious loss of stability which could arise due to large quantities of water accumulating on the deck or decks during the operation of the fixed pressure water-spraying system, the following arrangements shall be provided¹⁷:
- 6.1.4.1. in passenger ships:
 - 6.1.4.1.1. in the spaces above the bulkhead deck, scuppers shall be fitted so as to ensure that such water is rapidly

¹⁴ Refer to the Guidelines for the approval of alternative fixed water-based fire-fighting systems for special category spaces (MSC/Circ. 914).

¹⁵ Refer to the Recommendation on fixed fire-extinguishing systems for special category spaces adopted by the Organization by resolution A.123(V).

¹⁶ Refer to the Guidelines for the approval of alternative fixed water-based fire-fighting systems for special category spaces (MSC/Circ.914).

¹⁷ See furthermore chapter II-1, regulations 21.1.6.1 to 1.6.5.

discharged directly overboard, taking into account the guidelines developed by the Organization;¹⁸

6.1.4.1.2.

6.1.4.1.2.1. in ro-ro passenger ships, discharge valves for scuppers, fitted with positive means of closing operable from a position above the bulkhead deck in accordance with the requirements of the International Convention on Load Lines in force, shall be kept open while the ships are at sea;

6.1.4.1.2.2. any operation of valves referred to in paragraph 6.1.4.1.2.1 shall be recorded in the log-book;

6.1.4.1.3.

in the spaces below the bulkhead deck, the Administration may require pumping and drainage facilities to be provided additional to the requirements of regulation II-1/35-1. In such case, the drainage system shall be sized to remove no less than 125% of the combined capacity of both the water-spraying system pumps and the required number of fire hose nozzles, taking into account the guidelines developed by the Organization.¹⁹ The drainage system valves shall be operable from outside the protected space at a position in the vicinity of the extinguishing system controls. Bilge wells shall be of sufficient holding capacity and shall be arranged at the side shell of the ship at a distance from each other of not more than 40 m in each watertight compartment;

6.1.4.2. in cargo ships, the drainage and pumping arrangements shall be such as to prevent the build-up of free surfaces. In such case, the drainage system shall be sized to remove no less than 125% of the combined capacity of both the water-spraying system pumps and the required number of fire hose nozzles, taking into account the guidelines developed by the Organization.²⁰ The drainage system valves shall be operable from outside the protected space at a position in the vicinity of the extinguishing system controls. Bilge wells shall be of sufficient holding capacity and shall be arranged at the side shell of the ship at a distance from each other of not more than 40 m in each watertight compartment. If this is not possible, the adverse effect upon stability of the added weight and free surface of water shall be taken into account to the extent deemed necessary by the Administration in its

¹⁸ Refer to the Guidelines for drainage systems in closed vehicle and ro-ro spaces and special category spaces, to be developed by the Organization.

¹⁹ Refer to the Guidelines for drainage systems in closed vehicle and ro-ro spaces and special category spaces, to be developed by the Organization.

²⁰ Refer to the Guidelines for drainage systems in closed vehicle and ro-ro spaces and special category spaces, to be developed by the Organization.

approval of the stability information²¹. Such information shall be included in the stability information supplied to the master as required by regulation II-1/5-1.

6.1.5. On all ships, for closed vehicles and ro-ro spaces and special category spaces, where fixed pressure water-spraying systems are fitted, means shall be provided to prevent the blockage of drainage arrangements, taking into account the guidelines developed by the Organization.²² Ships constructed before 1 January 2010 shall comply with the requirements of this paragraph by the first survey after 1 January 2010.

6.2. Portable fire extinguishers

6.2.1. Portable fire extinguishers shall be provided at each deck level in each hold or compartment where vehicles are carried, spaced not more than 20 m apart on both sides of the space. At least one portable fire extinguisher shall be located at each access to such a cargo space.

6.2.2. In addition to the provision of paragraph 6.2.1, the following fire-extinguishing appliances shall be provided in vehicle, ro-ro and special category spaces intended for the carriage of motor vehicles with fuel in their tanks for their own propulsion:

6.2.2.1. at least three water-fog applicators; and

6.2.2.2. one portable foam applicator unit complying with the provisions of the Fire Safety Systems Code, provided that at least two such units are available in the ship for use in such spaces.

Regulation 21 – Casualty threshold, safe return to port and safe areas

1. Application

Passenger ships constructed on or after 1 July 2010 having length, as defined in regulation II-1/2.5, of 120 m or more or having three or more main vertical zones shall comply with the provisions of this regulation.

2. Purpose

The purpose of this regulation is to establish design criteria for a ship's safe return to port under its own propulsion after a casualty that does not exceed the casualty threshold stipulated in paragraph 3 and also provides functional requirements and performance standards for safe areas.

3. Casualty threshold

The casualty threshold, in the context of a fire, includes:

3.1. loss of space of origin up to the nearest "A" class boundaries, which may be a part of the space of origin, if the space of origin is protected by a fixed fire extinguishing system; or

3.2. loss of the space of origin and adjacent spaces up to the nearest "A" class boundaries, which are not part of the space of origin.

4. Safe return to port²³

When fire damage does not exceed the casualty threshold indicated in paragraph 3, the ship shall be capable of returning to port while providing a safe area as defined in regulation 3. To be deemed capable of returning to port, the following systems shall remain operational in the remaining part of the ship not affected by fire:

²¹ Refer to the Recommendations on fixed fire-extinguishing systems for special category spaces adopted by the Organization by resolution A.123(V).

²² Refer to the Guidelines for drainage systems in closed vehicle and ro-ro spaces and special category spaces, to be developed by the Organization.

²³ Refer to the Performance standards for the systems and services to remain operational on passenger ships for safe return to port and orderly evacuation and abandonment after a casualty (MSC.1/Circ.1214).

- 4.1. propulsion;
 - 4.2. steering systems and steering-control systems;
 - 4.3. navigational systems;
 - 4.4. systems for fill, transfer and service of fuel oil;
 - 4.5. internal communication between the bridge, engineering spaces, safety centre, fire-fighting and damage control teams, and as required for passenger and crew notification and mustering;
 - 4.6. external communication;
 - 4.7. fire main system;
 - 4.8. fixed fire-extinguishing systems;
 - 4.9. fire and smoke detection system;
 - 4.10. bilge and ballast system;
 - 4.11. power-operated watertight and semi-watertight doors;
 - 4.12. systems intended to support “safe areas” as indicated in paragraph 5.1.2;
 - 4.13. flooding detection systems; and
 - 4.14. other systems determined by the Administration to be vital to damage control efforts.
5. **Safe area(s)**
- 5.1. **Functional requirements**
 - 5.1.1. the safe area(s) shall generally be internal space(s); however, the use of an external space as a safe area may be allowed by the Administration taking into account any restriction due to the area of operation and relevant expected environmental conditions;
 - 5.1.2. the safe area(s) shall provide all occupants with the following basic services²⁴ to ensure that the health of passengers and crew is maintained:
 - 5.1.2.1. sanitation;
 - 5.1.2.2. water;
 - 5.1.2.3. food;
 - 5.1.2.4. alternate space for medical care;
 - 5.1.2.5. shelter from the weather;
 - 5.1.2.6. means of preventing heat stress and hypothermia;
 - 5.1.2.7. light; and
 - 5.1.2.8. ventilation;
 - 5.1.3. ventilation design shall reduce the risk that smoke and hot gases could affect the use of the safe area(s); and
 - 5.1.4. means of access to life-saving appliances shall be provided from each area identified or used as a safe area, taking into account that a main vertical zone may not be available for internal transit.
 - 5.2. **Alternate space for medical care**
Alternate space for medical care shall conform to a standard acceptable to the Administration.²⁵

Regulation 22 – Design criteria for systems to remain operational after a fire casualty

1. Application

²⁴ Refer to the Performance standards for the systems and services to remain operational on passenger ships for safe return to port and orderly evacuation and abandonment after a casualty (MSC.1/Circ.1214).

²⁵ Refer to the Guidance on the establishment of medical and sanitation related programmes for passenger ships (MSC./Circ.1129).

Passenger ships constructed on or after 1 July 2010 having length, as defined in regulation II-1/2.2, of 120 m or more or having three or more main vertical zones shall comply with the provisions of this regulation.

2. Purpose

The purpose of this regulation is to provide design criteria for systems required to remain operational for supporting the orderly evacuation and abandonment of a ship, if the casualty threshold, as defined in regulation 21.3, is exceeded.

3. Systems²⁶

- 3.1. In case any one main vertical zone is unserviceable due to fire, the following systems shall be so arranged and segregated as to remain operational:
 - 3.1.1. fire main;
 - 3.1.2. internal communications (in support of fire-fighting as required for passenger and crew notification and evacuation);
 - 3.1.3. means of external communications;
 - 3.1.4. bilge systems for removal of fire-fighting water;
 - 3.1.5. lighting along escape routes, at assembly stations and at embarkation stations of life-saving appliances; and
 - 3.1.6. guidance systems for evacuation shall be available.
- 3.2. The above systems shall be capable of operation for at least 3 h on the assumption of no damage outside the unserviceable main vertical zone. These systems are not required to remain operational within the unserviceable main vertical zones.
- 3.3. Cabling and piping within a trunk constructed to an “A-60” standard shall be deemed to remain intact and serviceable while passing through the unserviceable main vertical zone for the purposes of paragraph 3.1. An equivalent degree of protection for cabling and piping may be approved by the Administration.

Regulation 23 – Safety centre on passenger ships

1. Application

Passenger ships constructed on or after 1 July 2010 shall have on board a safety centre complying with the requirements of this regulation.

2. Purpose

The purpose of this regulation is to provide a space to assist with the management of emergency situations.

3. Location and arrangement

The safety centre shall either be a part of the navigation bridge or be located in a separate space adjacent to and having direct access to the navigation bridge, so that the management of emergencies can be performed without distracting watch officers from their navigational duties.

4. Layout and ergonomic design

The layout and ergonomic design of the safety centre shall take into account the guidelines developed by the Organization²⁷, as appropriate.

5. Communications

Means of communication between the safety centre, the central control station, the navigation bridge, the engine control room, the storage room(s) for fire extinguishing system(s) and fire equipment lockers shall be provided.

6. Control and monitoring of safety systems

²⁶ Refer to the Performance standards for the systems and services to remain operational on passenger ships for safe return to port and orderly evacuation and abandonment after a casualty (MSC.1/Circ.1214).

²⁷ Refer to guidelines to be developed by the Organization.

Notwithstanding the requirements set out elsewhere in the SOLAS Convention, the full functionality (operational, control, monitoring or any combination thereof, as required) of the safety systems listed below shall be available from the safety centre:

- 6.1. all powered ventilation systems;
- 6.2. fire doors;
- 6.3. general emergency alarm system;
- 6.4. public address system;
- 6.5. electrically powered evacuation guidance systems;
- 6.6. watertight and semi-watertight doors;
- 6.7. indicators for shell doors, loading doors and other closing appliances;
- 6.8. water leakage of inner/outer bow doors, stern doors and any other shell door;
- 6.9. television surveillance system;
- 6.10. fire detection and alarm system;
- 6.11. fixed fire-fighting local application system(s);
- 6.12. sprinkler and equivalent systems;
- 6.13. water-based systems for machinery spaces;
- 6.14. alarm to summon the crew;
- 6.15. atrium smoke extraction system;
- 6.16. flooding detection systems; and
- 6.17. fire pumps and emergency fire pumps.

Notice from the Danish Maritime Authority B –

The Construction and Equipment, etc. of Ships

Chapter B II-2 N(1)

Fire protection, fire detection and fire extinction

The provisions of this chapter consists of chapter 5 of the “Fire Safety Systems Code” (FSS Code) as well as national Danish requirements for fixed fire-extinguishing systems. The provisions of the FSS Code are in ordinary typescript, while the national Danish provisions are in italics.

Part A – High-pressure CO₂ systems

1 Application

This chapter details the specifications for fixed gas fire-extinguishing systems as required by chapter II-2 of the Convention.

2 Engineering specifications

2.1 General

2.1.1 Fire-extinguishing medium

2.1.1.1 Where the quantity of the fire-extinguishing medium is required to protect more than one space, the quantity of medium available need not be more than the largest quantity required for any one space so protected. The system shall be fitted with normally closed control valves arranged to direct the agent into the appropriate space.

2.1.1.2 The volume of starting air receivers, converted to free air volume, shall be added to the gross volume of the machinery space when calculating the necessary quantity of the fire-extinguishing medium. Alternatively, a discharge pipe from the safety valves may be fitted and led directly to the open air.

2.1.1.3 Means shall be provided for the crew to safely check the quantity of the fire-extinguishing medium in the containers.

2.1.1.4 Containers for the storage of fire-extinguishing medium, piping and associated pressure components shall be designed to pressure codes of practice to the satisfaction of the Administration having regard to their locations and maximum ambient temperatures expected in service.¹

2.1.2 Installation requirements

2.1.2.1 The piping for the distribution of fire-extinguishing medium shall be arranged and discharge nozzles so positioned that a uniform distribution of the medium is obtained. System flow calculations shall be performed using a calculation technique acceptable to the Administration.

2.1.2.2 Except as otherwise permitted by the Administration, pressure containers required for the storage of fire-extinguishing medium, other than steam, shall be located outside the protected spaces in accordance with regulation II-2/10.4.3 of the Convention.

2.1.2.3 Spare parts for the system shall be stored on board and be to the satisfaction of the Administration.

¹ Chapter B II-1 N(1) ISO – 9809-1: Refillable seamless steel gas cylinders (design, construction and testing).

- 2.1.2.4 In piping sections where valve arrangements introduce sections of closed piping, such sections shall be fitted with a pressure relief valve and the outlet of the valve shall be led to open deck.
- 2.1.2.5 All discharge piping, fittings and nozzles in the protected spaces shall be constructed of materials having a melting temperature which exceeds 925°C. The piping and associated equipment shall be adequately supported.
- 2.1.2.6 A fitting shall be installed in the discharge piping to permit the air testing as required by paragraph 2.2.3.1.
- 2.1.3 **System control requirements**
- 2.1.3.1 The necessary pipes for conveying fire-extinguishing medium into the protected spaces shall be provided with control valves so marked as to indicate clearly the spaces to which the pipes are led. Suitable provisions shall be made to prevent inadvertent release of the medium into the space. Where a cargo space fitted with a gas fire-extinguishing system is used as a passenger space, the gas connection shall be blanked during such use. The pipes may pass through accommodations providing that they are of substantial thickness and that their tightness is verified with a pressure test, after their installation, at a pressure head not less than 5 N/mm². In addition, pipes passing through accommodation areas shall be joined only by welding and shall not be fitted with drains or other openings within such spaces. The pipes shall not pass through refrigerated spaces.
- 2.1.3.2 Means shall be provided for automatically giving audible and visual warning of the release of fire-extinguishing medium into any ro-ro spaces and other spaces in which personnel normally work or to which they have access. The audible alarms shall be located so as to be audible throughout the protected space with all machinery operating, and the alarms should be distinguished from other audible alarms by adjustment of sound pressure or sound patterns. The pre-discharge alarm shall be automatically activated (e.g., by opening of the release cabinet door). The alarm shall operate for the length of time needed to evacuate the space, but in no case less than 20 s before the medium is released. Conventional cargo spaces and small spaces (such as compressor rooms, paint lockers, etc.) with only a local release need not be provided with such an alarm.
- 2.1.3.3 The means of control of any fixed gas fire-extinguishing system shall be readily accessible, simple to operate and shall be grouped together in as few locations as possible at positions not likely to be cut off by a fire in a protected space. At each location there shall be clear instructions relating to the operation of the system having regard to the safety of personnel.
- 2.1.3.4 Automatic release of fire-extinguishing medium shall not be permitted, except as permitted by the Administration.
- 2.2 **Carbon dioxide systems**
- 2.2.1 **Quantity of fire-extinguishing medium**
- 2.2.1.1 For cargo spaces, the quantity of carbon dioxide available shall, unless otherwise provided, be sufficient to give a minimum volume of free gas equal to 30% of the gross volume of the largest cargo space to be protected in the ship.
- 2.2.1.2 For machinery spaces, the quantity of carbon dioxide carried shall be sufficient to give a minimum volume of free gas equal to the larger of the following volumes, either:
 - 2.2.1.2.1 40% of the gross volume of the largest machinery space so protected, the volume to exclude that part of the casing above the level at which the horizontal area of the casing is 40% or less of the horizontal area of the space concerned taken midway between the tank top and the lowest part of the casing; or
 - 2.2.1.2.2 35% of the gross volume of the largest machinery space protected, including the casing.

- 2.2.1.3** The percentages specified in paragraph 2.2.1.2 above may be reduced to 35% and 30%, respectively, for cargo ships of less than 2,000 gross tonnage where two or more machinery spaces, which are not entirely separate, are considered as forming one space.
- 2.2.1.4** For the purpose of this paragraph the volume of free carbon dioxide shall be calculated at 0.56 m³/kg.
- 2.2.1.5** For machinery spaces, the fixed piping system shall be such that 85% of the gas can be discharged into the space within 2 min.

2.2.2 Controls

Carbon dioxide systems shall comply with the following requirements:

- 2.2.2.1** two separate controls shall be provided for releasing carbon dioxide into a protected space and to ensure the activation of the alarm. One control shall be used for opening the valve of the piping which conveys the gas into the protected space and a second control shall be used to discharge the gas from its storage containers. Positive means shall be provided so they can only be operated in that order; and
- 2.2.2.2** the two controls shall be located inside a release box clearly identified for the particular space. If the box containing the controls is to be locked, a key to the box shall be in a break-glass-type enclosure conspicuously located adjacent to the box.
- 2.2.2.3 Release arrangement**
- 2.2.2.3.1** *If the CO₂ quantity exceeds 225 kg, a servo-operated arrangement for release of the containers shall be available for opening container valves and main stop valves. Wire control arrangements shall not be permitted in such systems.*
- 2.2.2.3.2** *Servo-operated release stations shall be located outside the CO₂ space.*
- 2.2.2.3.3** *The servo-operated arrangement shall be arranged and made so that it can be ventilated at the release station and that any fault in the manoeuvre sequence does not prevent the release of the CO₂ quantity.*
- 2.2.2.3.4** *It shall be possible to manually open and close main stop valves locally at the maximum CO₂ pressure in the manifold. The valve shall be provided with indicators for open and closed position, and it shall be so placed that it is easily accessible.*
- 2.2.2.3.5** *Where a pneumatic and/or hydraulic servo-arrangement is used, an intermediate stop valve shall be fitted in the pipeline operable from the release station.*
- 2.2.2.3.6** *If CO₂ is used for the operation of the servo arrangement, it shall not be possible to vent the installation to an enclosed space, such as the CO₂ space, unless the concentration of CO₂ will become less than 0.5 per cent of the space in question.*
- 2.2.2.3.7** *Operating devices and all components associated with the servo arrangements, including any power sources and pipelines, shall, in terms of fire technology, be independent of the space or spaces protected by the installation.*
- 2.2.2.3.8** *Pipes in the control system from the release cabinet to CO₂ spaces shall be made of stainless steel.*
- 2.2.2.3.9** *Time-delay relays in release circuits shall function in all conditions ("dead ship", etc.). It shall be possible to disconnect the time-delay function, and it shall be clearly stated at each release arrangement and at the time-delay relay how they function and how they are disconnected.*
- 2.2.2.4. Alarm equipment, etc. for "total flooding" installations**
- 2.2.2.4.1** *In CO₂ protected spaces, a visual and acoustic alarm shall be fitted marked "CO₂ ALARM". The alarm system shall be made in accordance with the provisions of the "Code on Alarm and Indicators".*
- 2.2.2.4.2** *Adequate measures shall be taken to secure the reliability of the alarm system. Such measures include the marking and locking in the open position of certain valves for*

propelling gas and special marking of electric switches and fuses. It shall not be possible to put the alarm out of operation because of a fire in the CO₂ protected space, and electric alarm equipment shall be supplied from the emergency source of power. Alarm signal devices propelled by the released CO₂ gas cannot be approved as prescribed alarm signal devices in working spaces.

2.2.2.4.3 *Manifolds shall be provided with a pressure gauge and a pressure transmitter. The pressure transmitter shall be connected to the engine alarm system or other suitable alarm systems.*

2.2.2.5 CO₂ spaces

2.2.2.5.1 *Spaces where CO₂ containers are stored shall be separately ventilated, shall have direct access from open deck and may not be used for other purposes. Access to the CO₂ space may not be by means of vertical ladders.*

2.2.2.5.2 *The spaces shall be insulated, ventilated and arranged in such a way that the temperature shall not normally exceed 40°C.*

2.2.2.5.3 *Extraction blowers shall have a capacity of at least 6 air changes per hour. The blowing engine shall be power supplied from the ship's emergency switchboard.*

2.2.2.5.4 *Any drainage shall be led separately over board or to the open deck.*

2.2.2.5.5 *All doors and hatches shall be easily operable from both sides.*

2.2.2.5.6 *Communication shall be possible by means of ordinary telephones between the navigation bridge or the fire control room and the release stations of the system. In small ships, portable radio telephones or the like may be accepted.*

2.2.2.5.7 *CO₂ containers shall be solidly fixed in an upright position and arranged in such a way that the container valves are easily accessible for control². Furthermore, the containers shall be isolated from the deck to prevent outside corrosion.*

2.2.2.6 CO₂ containers

2.2.2.6.1 *The CO₂ containers shall comply with the Danish regulations for such containers in force at any time. CO₂ containers complying with foreign standards may be used provided that they comply with the rules of a recognised classification society.*

2.2.2.6.2 *Every container or container valve³ shall be provided with a frangible disc guaranteed by the manufacturer to protect the container against harmful overpressure, and the arrangement shall permit free passage of gas from the container if the frangible disc breaks.*

2.2.2.6.3 *Tare and gross weights, month and year of the latest pressure test as well as the test pressure shall be stamped on the container.*

2.2.2.6.4 *The companies that charge the containers are responsible for the content, which may not exceed 0.67 kg per litre of the container volume. The companies shall issue a certificate stating the content of each container.*

2.2.2.6.5 *If a weight loss of 10 per cent or more of the charged weight stamped on the container is observed in connection with a control measurement of CO₂ containers, the container in question shall be recharged, however the extinguishing capacity required shall always be available.*

2.2.2.6.6 *CO₂ containers shall be pressure-tested every 10 years. A discharged container may not be recharged until a new pressure test has been carried out with a satisfactory result if more than 5 years have passed since the latest pressure test.*

² Reference is also made to the Guidance on installations with high-pressure CO₂ systems for the protection of machinery spaces issued by the Danish Maritime Authority.

³ Reference is also made to the Guidance on installations with high-pressure CO₂ systems for the protection of machinery spaces issued by the Danish Maritime Authority.

- 2.2.2.6.6.1** *If the CO₂ containers are found at an external inspection in connection with the annual inspections to be in satisfactory condition with an intact surfacing, the first pressure-test period may be extended for up to 20 years. This does not apply to CO₂ containers that have been emptied, have lost their pressure or weight, cf. 2.2.2.6.5, or to CO₂ containers that have corroded or are in any other way externally damaged.*
- 2.2.2.6.6.2** *Subsequent pressure-test periods shall be for 10 years.*
- 2.2.2.7 CO₂ piping, etc.**
- 2.2.2.7.1** *All pipes outside machinery and boiler spaces shall be externally and internally galvanised, and the fittings used shall be corrosion-resistant.*
- 2.2.2.7.2** *Only flexible high-pressure hoses⁴ approved for the purpose shall be permitted between container valves and the manifold of the CO₂ containers.*
- 2.2.2.7.3** *The internal diameter of CO₂ containers' connections to manifolds shall be at least 10 mm.*
- 2.2.2.7.4** *Non-return valves shall be fitted between each individual container and the manifold in such a way that a container may, if necessary, be disconnected from the manifold without putting the system out of operation. The non-return valve shall be permanently fitted on the manifold.*
- 2.2.2.7.5** *Immediately after the main stop valve, a connection facility for testing the free flow of air through the whole distributing system shall be fitted, cf. 2.1.2.6 and 2.2.3.1.*
- 2.2.2.7.6** *The CO₂ piping including the manifold shall be made of certificated seamless steel pipes. Only flanges for pressure level 10 N/mm² may be used. Manifolds shall be fitted with a safety pressure release valve with an outlet pipe leading to the open air. The valve shall open at 13 N/mm² and have a size so as to prevent dangerous overpressure in the manifold. External diameters and wall thicknesses shall be in accordance with table 1. Wall thickness deviations may be permitted for pipes manufactured in accordance with other standards, cf. 2.1.1.4.*

*Table 1
Manifolds, including pipes to blind flange after main stop valve*

<i>Nominal diameter in mm</i>	<i>Wall thickness in mm</i>
20	3.2
25	4.0
32	4.0
40	4.0
50	4.5
65	5.0
80	5.6
100	7.1
125	8.0
150	8.8

- 2.2.2.7.7** *Distributing valves for cargo spaces shall be of the quick-opening type in order to prevent freezing and the cargo space or spaces to which they are connected shall be clearly indicated by marking.*

⁴ *Reference is also made to the Guidance on installations with high-pressure CO₂ systems for the protection of machinery spaces issued by the Danish Maritime Authority.*

2.2.2.7.8 All the fittings used between container valves and main stop valves and distributing valve manifold shall be made of steel. Threaded fittings may be used only up to 2" pipe thread.

2.2.2.7.9 Main stop valves shall be made of steel and be designed for a working pressure of 10 N/mm².

2.2.2.7.10 All fittings used between main stop valves and between distributing valve manifold and outlet nozzles may be made of annealed castings or tough-hard iron, and the joints shall be made without free threads. Manifolds and pipes for the blind valve shall at least have an external diameter and wall thickness as given in table 1. Pipes from main stop valve or distributing valve manifold to outlet nozzles shall be calculated for a working pressure of 5N/mm² and at least have a wall thickness as stated in table 2. Wall thickness deviations may be permitted for pipes manufactured according to other standards, cf. 2.1.1.4.

Table 2

Pipes from main stop valve/distributing valve manifold to outlet nozzles

Nominal diameter in mm	Wall thickness in mm
20	2.6
25	3.2
32	3.2
40	3.2
50	3.6
65	3.6
80	4.0
100	4.5
125	5.0
150	5.6

2.2.2.7.11 CO₂ pipes for "total flooding" systems for machinery spaces shall be designed in accordance with the amount of CO₂ that they are meant to carry. The maximum amount of CO₂ may not exceed the values stated in table 3.

Table 3

Maximum amount of CO₂ through pipes and main stop valves in total flooding systems

CO ₂ quantity	Internal pipe diameter
45 kg	13 mm
100 kg	19 mm
135 kg	25 mm
275 kg	32 mm
450 kg	38 mm
1,100 kg	50 mm
2,000 kg	76 mm
3,250 kg	89 mm
4,750 kg	101 mm
6,800 kg	114 mm
9,500 kg	127 mm
15,250 kg	152 mm

2.2.2.8 Pressure testing of pipes

2.2.2.8.1 The entire pipe system shall be hydraulically pressure-tested.

2.2.2.8.2 The test pressure for the manifold, i.e. the pipe system between the non-return valves in the container connections and the protection against inadvertent release, shall be at least 19 N/mm².

2.2.2.8.3 The test pressure between the protection against inadvertent release and outlet nozzles shall be at least 2.5 N/mm².

2.2.2.8.4 The test pressure of pipes in the control system shall be at least 1.3 times the working pressure.

2.2.2.8.5 The pressure-tests of manifolds stipulated in 2.2.2.8.2 may be carried out before installed on board if a pressure test certificate from the manufacturer can be presented.

2.2.2.8.6 The pressure-tests stipulated in 2.2.2.8.3 and 2.2.2.8.4 shall be carried out after the installation on board the ship.

2.2.3 Testing of the installation

When the system has been installed, pressure-tested and inspected, the following shall be carried out:

2.2.3.1 a test of the free air flow in all pipes and nozzles;

2.2.3.2 a functional test of the alarm equipment; and

2.2.3.2.1 *the operation of the control equipment⁵, including release of the system to the main stop valve with the protection mentioned in 2.2.3.3.1 against inadvertent release activated (“total flooding” test).*

2.2.3.3. Special provisions

2.2.3.3.1 *It shall be possible to protect the system against inadvertent release during maintenance, dry-docking and the like, cf. 2.1.3.1. This may be done by means of a valve locked in the closed position or by inserting blank flange (sliding flange) after the main stop valve. It shall be possible to test the system, cf. 2.2.3.2.1, when the system is protected against inadvertent release.*

2.2.3.3.2 *Local CO₂ systems installed for the purpose of extinguishing fires in machinery, such as scavenging air fires in diesel engines, are permitted if installed in a suitable place in the engine room and provided the CO₂ concentration does not exceed 0.5 per cent in the space in question.*

2.2.3.3.3 *All doors to spaces protected by a CO₂ system shall have a clear sign stating that the space is protected by a CO₂ fire-extinguishing system and that the space shall be left immediately if the alarm sounds.*

2.2.3.4. Inspection, control and maintenance

2.2.3.4.1 *Suppliers of CO₂ systems shall provide a description of the system, including a checklist for maintenance, in Danish and/or English.*

2.2.3.4.2 *The CO₂ system shall be maintained and inspected in accordance with the checklist for maintenance mentioned in 2.2.3.4.1 as well as in accordance with recognised guidelines for maintenance and inspection of fixed CO₂ fire-extinguishing systems.⁶*

2.2.3.4.3 *The quantity of CO₂ shall be checked at least once a year. The quantity shall be checked through measurements.*

2.2.3.4.4 *The on-going maintenance, etc. performed by the chief engineer or on the initiative of the ship's management shall be recorded in the annex file of the ship or in the ship's safety*

⁵ Reference is also made to the Guidance on testing of CO₂ systems issued by the Danish Maritime Authority.

⁶ IMO Guidelines on the maintenance and inspections of fixed carbon dioxide fire-extinguishing systems (MSC.1/Circ.1318).

management system, stating the extent of the inspection and any repairs and improvements made.

Part B – Low-pressure CO₂ systems

2.2.4 Low-pressure CO₂ system

Where a low pressure CO₂ system is fitted to comply with this regulation, the following applies.

2.2.4.1 The system control devices and the refrigerating plants shall be located within the same room where the pressure vessels are stored.

2.2.4.1.1 *Except for the item on CO₂ containers, the provisions on high-pressure CO₂ systems shall apply by analogy, though pipe and nozzle calculations shall be submitted to the Danish Maritime Authority in each individual case.*

2.2.4.1.2 *Vessels for storing CO₂ (CO₂ vessels) shall, as regards their construction, materials, scantling and test pressure, comply with rules corresponding to those used by a recognised classification society or by a recognised authority. The vessels shall be marked so that it is possible to identify them and be marked with the test pressure and test date as well as the working pressure, cubic contents and supervisor mark.*

2.2.4.2 The rated amount of liquid carbon dioxide shall be stored in vessel(s) under the working pressure in the range of 1.8 N/mm² to 2.2 N/mm². The normal liquid charge in the container shall be limited to provide sufficient vapour space to allow for expansion of the liquid under the maximum storage temperatures than can be obtained corresponding to the setting of the pressure relief valves but shall not exceed 95% of the volumetric capacity of the container.

2.2.4.3 Provision shall be made for:

2.2.4.3.1 pressure gauge;

2.2.4.3.1.1 *It shall be possible to close the pressure gauge from the vessel;*

2.2.4.3.2 high pressure alarm: not more than setting of the relief valve;

2.2.4.3.3 low pressure alarm: not less than 1.8 N/mm²;

2.2.4.3.4 branch pipes with stop valves for filling the vessel;

2.2.4.3.4.1 *it shall be possible to isolate all pipes exiting from the vessel, with the exception of the nozzle for the safety valve, by a means of closing directly on the vessel;*

2.2.4.3.5 discharge pipes;

2.2.4.3.6 liquid CO₂ level indicator, fitted on the vessel(s);

2.2.4.3.6.1 *on each vessel, an external pipe for measuring the CO₂ liquid level shall be fitted, and each vessel shall have an automatically functioning level control activating an alarm at 95% minimum CO₂ contents;*

2.2.4.3.6.2 *means for checking the CO₂ quantity shall be designed so that damage will not cause leakage;*

2.2.4.3.7 two safety valves; and

2.2.4.3.7.1 *it shall be possible to lock the main stop valve on the CO₂ vessel in the closed position.*

2.2.4.4 The two safety relief valves shall be arranged so that either valve can be shut off while the other is connected to the vessel. The setting of the relief valves shall not be less than 1.1 times working pressure. The capacity of each valve shall be such that the vapours generated under fire condition can be discharged with a pressure rise not more than 20% above the setting pressure. The discharge from the safety valves shall be led to the open.

2.2.4.4.1 *A three-way valve may be fitted between the safety valves and the vessel when the valve is arranged so that it is possible to close only one safety valve at a time and when there is always a free flow of air irrespective of the position of the valve.*

- 2.2.4.4.2** *The exit of outlet pipes from safety valves that shall be led to open deck, cf. 2.2.4.4, shall be located so that CO₂ cannot flow into the inner part of the ship. The flow area of the pipe shall be at least 2 times the total flow area of the valves.*
- 2.2.4.5** The vessel(s) and outgoing pipes permanently filled with carbon dioxide shall have thermal insulation preventing the operation of the safety valve in 24 h after de-energizing the plant, at ambient temperature of 45 °C and an initial pressure equal to the starting pressure of the refrigeration unit.
- 2.2.4.6** The vessel(s) shall be serviced by two automated completely independent refrigerating units solely intended for this purpose, each comprising a compressor and the relevant prime mover, evaporator and condenser.
- 2.2.4.7** The refrigerating capacity and the automatic control of each unit shall be so as to maintain the required temperature under conditions of continuous operation during 24 h at sea temperatures up to 32 °C and ambient air temperatures up to 45 °C.
- 2.2.4.8** Each electric refrigerating unit shall be supplied from the main switchboard busbars by a separate feeder.
- 2.2.4.8.1** One of the refrigerating units shall be supplied from the emergency switchboard, and it need not be supplied from the main switchboard as well.
- 2.2.4.9** Cooling water supply to the refrigerating plant (where required) shall be provided from at least two circulating pumps one of which being used as a stand-by. The stand-by pump may be a pump used for other services so long as its use for cooling would not interfere with any other essential service of the ship. Cooling water shall be taken from not less than two sea connections, preferably one port and one starboard.
- 2.2.4.10** Safety relief devices shall be provided in each section of pipe that may be isolated by block valves and in which there could be a build-up of pressure in excess of the design pressure of any of the components.
- 2.2.4.11** Audible and visual alarms shall be given in a central control station or, in accordance with regulation II-1/51, where a central control station is not provided, when:
- 2.2.4.11.1** the pressure in the vessel(s) reaches the low and high values according to paragraph 2.2.4.2;
- 2.2.4.11.2** any one of the refrigerating units fails to operate; or
- 2.2.4.11.3** the lowest permissible level of the liquid in the vessels is reached.
- 2.2.4.12** If the system serves more than one space, means for control of discharge quantities of CO₂ shall be provided, e.g. automatic timer or accurate level indicators located at the control position(s).
- 2.2.4.13** If a device is provided which automatically regulates the discharge of the rated quantity of carbon dioxide into the protected spaces, it shall be also possible to regulate the discharge manually.
- 2.2.4.14** ***Pressure-testing and inspection***
- 2.2.4.14.1** *CO₂ tanks shall be pressure-tested before installed on board, and subsequently the tanks together with fittings shall be inspected externally every 5 years. At the external inspections every 5 years, the insulation material of the vessel shall be removed only at the points at which this is considered necessary. Pipes and valves at transitional points between insulated and un-insulated areas (cold-conductors) as well as vessel supports, flange sockets and valves shall be covered by the external inspection every 5 years.*
- 2.2.4.14.2** *The installation shall be inspected on an ongoing basis in accordance with the description of the installation supplied by the manufacturer, including a checklist for maintenance. At least once a year, a thorough external inspection of the vessel supports, flange sockets and valves mentioned in 2.2.4.14.1 shall be carried out. In addition, the CO₂*

installation shall be maintained and inspected in accordance with the relevant parts of the recognised guidelines on the maintenance and inspection of fixed CO₂ fire-extinguishing systems.⁷

2.2.4.14.3 *The result and the extent of the external inspections referred to in 2.2.4.14.1 and 2.2.4.14.2 as well as any repairs and improvements made shall be recorded in the annex file of the ship or the ship's safety management system.*

2.2.4.15 Leakage alarm

2.2.4.15.1 *An automatic alarm for CO₂ leakage in the vessel space shall be provided. The alarm shall be connected to the engine alarm panel, and it shall come into operation before the concentration of CO₂ gas in the room has reached 0.5 per cent.*

2.3 Requirements of steam systems

The boiler or boilers available for supplying steam shall have an evaporation of at least 1 kg of steam per hour for each 0.75 m³ of the gross volume of the largest space so protected. In addition to complying with the foregoing requirements, the systems in all respects shall be as determined by, and to the satisfaction of, the Administration.

2.4 Systems using gaseous products of fuel combustion

2.4.1 General

Where gas other than carbon dioxide or steam, as permitted by paragraph 2.3, is produced on the ship and is used as a fire-extinguishing medium, the system shall comply with the requirements in paragraph 2.4.2.

2.4.2 Requirements of the systems

2.4.2.1 Gaseous products

Gas shall be a gaseous product of fuel combustion in which the oxygen content, the carbon monoxide content, the corrosive elements and any solid combustible elements in a gaseous product shall have been reduced to a permissible minimum.

2.4.2.2 Capacity of fire-extinguishing systems

2.4.2.2.1 Where such gas is used as the fire-extinguishing medium in a fixed fire-extinguishing system for the protection of machinery spaces, it shall afford protection equivalent to that provided by a fixed system using carbon dioxide as the medium.

2.4.2.2.2 Where such gas is used as the fire-extinguishing medium in a fixed fire-extinguishing system for the protection of cargo spaces, a sufficient quantity of such gas shall be available to supply hourly a volume of free gas at least equal to 25% of the gross volume of the largest space protected in this way for a period of 72 h.

2.5 Equivalent fixed gas fire-extinguishing systems for machinery spaces and cargo pump-rooms

Fixed gas fire-extinguishing systems equivalent to those specified in paragraphs 2.2 to 2.4 shall be approved by the Administration based on the guidelines developed by the Organization.

⁷ IMO Guidelines on the maintenance and inspections of fixed carbon dioxide fire-extinguishing systems (MSC.1/Circ.1318).

Notice from the Danish Maritime Authority B –

The Construction and Equipment, etc. of Ships

Chapter B II-2 N(2)

Supplement to the provisions of the Fire Safety Systems Code (FSS Code), chapter 5

<i>1. General.....</i>	<i>1</i>
<i>2. Tests</i>	<i>1</i>
<i>3. Installation</i>	<i>1</i>
<i>4. Testing on board</i>	<i>2</i>
<i>5. Installation of pressure containers and surveillance system</i>	<i>3</i>
<i>6. Pressure containers.....</i>	<i>4</i>
<i>7. Alarm and release arrangement</i>	<i>4</i>
<i>8. Local, automatic systems</i>	<i>5</i>
<i>9. Inspection and checks</i>	<i>5</i>

Installation and testing of fire extinction systems with mixed atmospheric gases in engine spaces on board ships

1. General

The provisions of chapter 5 of "the Fire Safety Systems Code" shall apply by analogy.

2. Tests

- 2.1. Each individual mixture of gases shall be tested in accordance with the standard tests stipulated in MSC/Circ.848.*
- 2.2. A recognised test company shall test the mixture of gases with a satisfactory result in accordance with the standard tests referred to in .1 above. The approval certificate from such a test company shall, among other things, state the composition of the mixture and the minimum and maximum oxygen concentrations permitted in the protected space when the extinguishant has been released (the concentration of extinguishant).*

3. Installation

- 3.1. Under normal circumstances, the system may be designed only for manual release.*
- 3.2. In special cases, the Danish Maritime Authority may, however, permit automatic release of both new and existing fire extinction systems provided that:
 - 3.2.1. the ship in question is not covered by the provisions of the SOLAS Convention;*
 - 3.2.2. a green indicator lamp and a sign on the release panel indicate when the system has been set for manual release;**

3.2.3. a red indicator lamp and a sign on the release panel indicate when the system has been set for automatic release;

3.2.4. a conspicuous red sign with white letters (about 30 pitch) is affixed below the red indicator lamp with the following text:

"When at sea, the system may not be set for automatic release."

- 3.3. *If the system is intended to serve more than one space, its storage and release functions shall be arranged so as to ensure that the required volumes of extinguishant are released into the spaces.*
- 3.4. *Means shall be provided for automatic stop of all ventilators serving the protected space before the extinguishant is released.*
- 3.5. *At the release point or points, written instructions shall be available clearly stating that all ventilation and all combustion engines must be stopped and that all fire dampers and hatches shall be closed before the system is released.*
- 3.6. *The release arrangement shall be designed so that 85% of the amount of extinguishant required according to the approval certificate is released within a maximum period of 120 seconds.*
- 3.7. *It shall be possible to maintain the minimum concentration of extinguishant in the space for at least 15 minutes.*
- 3.8. *The system shall be designed to resist temperatures, vibrations, shocks and mechanical impact, fouling and corrosion as well as moist that may occur in the space where the system is installed.*
- 3.9. *The release of the system as well as any release via the frangible discs of the containers may not present any danger to personnel engaged in the maintenance of equipment or using the normal access ladders to and exits from the space.*
- 3.10. *It shall be possible for the crew to check the pressure (the content) of the containers without any risk.*
- 3.11. *Unless otherwise provided, the amount of the mixture of gases available for cargo spaces shall be sufficient to produce the minimum volume of free mixture stated on the approval certificate. If two or more cargo spaces are connected through ventilation ducts, such spaces shall be considered one space.*
- 3.12. *The amount of the mixture of gases available for engine spaces shall be sufficient to produce the minimum volume of free mixture stated on the approval certificate. Two or more engine spaces of category A that are not separate shall be considered one space.*
- 3.13. *The number and location of nozzles shall be such as to achieve a homogenous distribution of the mixture of gases in the space.*
- 3.14. *All doors leading to spaces protected by a system with atmospheric gases shall be clearly marked with a sign stating that the space is protected by a system with atmospheric gases and that the space shall be left when the alarm sounds.*

4. Testing on board

- 4.1. *The distribution and extinguishing capacity of each system installed shall be demonstrated in practice on board.*
- 4.2. *The extinguishant shall be tested in connection with a test fire that is under control in the form of fires caused by burning alcohol fuels in small trays placed at different levels in the engine room; during the test, the combustion engines and the ventilation shall have been stopped and the fire dampers shall have been closed. The fires shall be distributed evenly throughout the space.*

- 4.3. *When the extinguishant has been released, the concentration of oxygen in the engine space is measured in order to prove that the extinguishant has been well distributed. The concentration of oxygen may, at no point in time, be below 10% and not above 12%.
In addition, the following shall be checked:*
- 4.3.1. *How long time it takes to discharge the extinguishant into the space.*
- 4.3.2. *How long time it takes from the release of the system has taken place until all fires in the trays have been extinguished.*
- 4.3.3. *For how long time the concentration capable of extinguishing a fire is maintained (in accordance with the approval).*
- 4.3.4. *If, during the above tests, doubt arises as to the efficiency of the extinguishant, the Danish Maritime Authority may require further tests to be carried out.
The Danish Maritime Authority may, however, sustain from requiring such a test if previous tests carried out in spaces of the same design and size and with approximately the same number and location of nozzles have proved satisfactory.*
- 4.3.5. *The release arrangement shall be designed so that the release function can be demonstrated through activation of the valve arrangement. Such a check shall be demonstrated for the Danish Maritime Authority with a satisfactory result before the system is put into operation.*

5. Installation of pressure containers and surveillance system

- 5.1. *The mixture of gases may be stored in the protected space, cf. however paragraph 3.8. The location of the containers in the protected space and the release arrangement shall be such that at least 5/6 of the extinguishant may be discharged even if one of the release connections have been damaged because of fire or explosion. The containers shall always be divided into at least two sections.*
- 5.2. *A manual, servo-driven or electrically driven release arrangement shall be provided outside the protected space. Two sources of power shall be connected to this release arrangement, both of which shall be located outside the protected space and shall be readily available. In the case of engine rooms, one of the said sources of power may, however, be located in the protected space.*
- 5.3. *Electrical circuits shall be under surveillance for defects and power failure by means of visual and acoustic alarms.*
- 5.4. *Pneumatic, hydraulic or electrical release circuits connecting the containers shall be available in duplicate. Pneumatic or hydraulic sources of pressure shall be under surveillance for pressure failure by means of visual and acoustic alarms.*
- 5.5. *In the protected space, the electrical circuits needed to release the system shall be carried in fire-proof cables in accordance with the standards of the IEC. The required piping for hydraulic or pneumatic operation shall be made of steel or another similar heat-resistant material, which the Danish Maritime Authority can approve.*
- 5.6. *All doors leading to the protected space shall be marked with the following text:
"The space is connected to a fire-extinguishing system using fire-extinguishing gases and must be left immediately if the alarm sounds."*
- 5.7. *Arrangements in connection with systems serving spaces that require only one or two containers of ordinary size shall be executed to the satisfaction of the Danish Maritime Authority.*

6. Pressure containers

- 6.1. *The containers shall comply with the Danish or any other EU and EEA state provisions on containers of the type in question in force at any time. Containers manufactured in other countries may be permitted provided that they comply with a recognised standard in the country in question and that the safety level of this standard is similar to that of the EU or EEA states or provided that they comply with the regulations on such containers used by a recognised classification society. A maximum pressure of 30 N/mm² shall be permitted.*
- 6.2. *Any container or container valve shall be fitted with a frangible disc which, according to the manufacturer's guarantees, protects the container against harmful overpressure, and the arrangement shall allow gas to flow freely from the container if the frangible disc bursts.*
- 6.3. *The tare and gross weight, month and year of the latest pressure test as well as the test pressure shall be stamped on the containers.*
- 6.4. *Only the manufacturer or other companies approved by the manufacturer may charge the containers.
The companies are responsible for the charging of the containers and the composition of the mixture of gases.
The companies shall issue a certificate stating the composition of the mixture and this certificate shall be delivered together with the container.
Furthermore, in a conspicuous place, a durable label shall be affixed to the containers stating:*
 - 6.4.1. *the composition of the mixed, atmospheric mixture of gases;*
 - 6.4.2. *date and year of the charging;*
 - 6.4.3. *the name and address of the company responsible for the charging.*
- 6.5. *The containers shall be fixed and placed so that it is easy to check the container valves. Furthermore, they shall be stored above the floor and be protected against corrosion. The marking of the containers, including their label and the size of the connection for the outlet nozzle on both the container valve and container manifold shall be executed in accordance with the standards in force.*
- 6.6. *The containers shall be pressure tested every 10 years by a recognised test institute, a recognised classification society or by the chief engineer of the ship in question (only on board ships where a certificate of competency as a chief engineer officer is required in accordance with the STCW Convention, chapter III, regulation III-2).*
- 6.7. *If more than 5 years have passed since the latest pressure test, a discharged container may not be recharged until a renewed pressure test has been carried out with satisfactory result.*
- 6.8. *If, in connection with the inspection of the containers, a 10% loss of pressure or more is found, the container in question shall be recharged.*

7. Alarm and release arrangement

- 7.1. *Alarms for the surveillance of the system shall be located at a central point so that they are easily accessible to the responsible crewmembers at all times when the ship is at sea or in port.*
- 7.2. *The electrical circuits and/or pipes necessary to release a system as well as the location of the containers shall be such that it will be possible to release the entire fire-extinguishing volume prescribed in paragraph 3.11 or 3.12 to the protected space in case one of the release pipes is damaged by a fire or explosion in the space in question.*

7.3. *The containers shall be under surveillance for a drop in pressure caused by leakage and release. Visual and acoustic alarms shall be fitted that sound when 80% of the recharging pressure has been reached at 20 C.*

8. Local, automatic systems

- 8.1. *Local, automatic, permanently installed fire-extinguishing systems located in encased areas (in engine spaces) presenting a great fire hazard may be permitted provided that they are independent of the prescribed, permanently installed fire-extinguishing system.*
- 8.2. *The area where such an additional, local protection is provided shall primarily be at a working deck and at the same level as the access to the space. More than one working deck may be permitted at the discretion of the Danish Maritime Authority if means of access are provided at each level.*
- 8.3. *The size of the space and the means of access thereto as well as the location of the machinery shall be arranged so that it is possible to leave all points in the space in less than 10 seconds.*
- 8.4. *The activation of a system shall be indicated both visually and acoustically outside any means of access to the engine space and on the navigation bridge or in the space where the fire control equipment is located.*
- 8.5. *A sign stating that the space contains one or more automatic fire-extinguishing systems and giving the extinguishant used shall be affixed outside any means of access thereto.*
- 8.6. *Outlet nozzles and frangible discs shall be located so that the release does not present any danger to personnel using ordinary access ladders to and exits from the space. Furthermore, it shall be ensured that personnel engaged in the maintenance of machinery are protected against inadvertent release of extinguishants.*
- 8.7. *The system shall be designed to resist temperatures, vibrations, shocks and mechanical impact, fouling and corrosion as well as moist that may occur in the space where the system is installed.*
- 8.8. *Measures shall be taken to allow the crew to check the pressure (the content) of the containers without any risk.*
- 8.9. *The total amount of extinguishant in the local, automatic installations shall be such that the maximum permitted concentration of the mixture of gases, based on the net cubic capacity of the encased space, is not exceeded, cf. paragraph 4.3. This requirement shall be applied when either a local, automatic system or a permanently installed system has been released, but not if both systems have been released.*
- 8.10. *Local, automatic fire-extinguishing systems shall be designed so that their release does not lead to loss of electrical power or deterioration of the ship's manoeuvrability.*

9. Inspection and checks

- 9.1. *Manufacturers of systems shall also provide customers with a description of the system, including a checklist for maintenance.*
- 9.2. *The ship's chief engineer or a classification society or company recognised by the Danish Maritime Authority shall check the system at least once a year.*
- 9.3. *The continuous inspections, etc. carried out by the chief engineer or by order of the ship's management shall be recorded in the ship's survey book or in the ship's safety management system stating the extent of the survey, any repairs made as well as the date of the inspection.*

Notice from the Danish Maritime Authority B –

The Construction and Equipment, etc. of Ships

Chapter B II-2 N(3)

Additional Danish regulations

Supplement to the provisions of the Fire Safety Systems Code (FSS Code), chapter 4

<i>1. General.....</i>	<i>1</i>
<i>2. Monthly inspections of certain foam-extinguishers</i>	<i>1</i>
<i>3. Annual inspections of all types of fire-extinguishers</i>	<i>1</i>
<i>4. Periodical pressure tests, etc.</i>	<i>2</i>

Periodic surveys, etc. of fire-extinguishers

1. General

- 1.1. Fire-extinguishers and spare charges shall be ready for use at any time and be subjected to routine checks.*
- 1.2. The functioning of a suitable number of the ship's portable fire-extinguishers from both accommodation and engine spaces shall be systematically tested in connection with fire drills.*
- 1.3. The inspections prescribed in regulations 2 and 3 may be carried out on board on the responsibility of the master, chief engineer or chief officer of the ship in question provided that the manufacturer's service instructions for each individual type of extinguisher on board are followed. The chief engineer of the ship in question may carry out the pressure tests mentioned in regulation 4 provided that he or she holds a certificate of competency as a chief engineer. If the said inspections and pressure tests are not carried out on board, they shall be carried out by recognised companies, persons or test institutes in this country. Abroad inspections and tests may be carried out by local, recognised companies.*

2. Monthly inspections of certain foam-extinguishers

As to protein foam-extinguishers with mixed foam-charges located in engine spaces or in spaces where the temperature normally exceeds 25° C, the charge shall be replaced every four months by a new spare charge on which the manufacturer has stamped the date of manufacture which may not be older than one year. Spare charges shall be stored at a temperature below 15° C.

3. Annual inspections of all types of fire-extinguishers

3.1 CO₂ fire-extinguishers

The weight of the fire-extinguisher shall be checked after it has been fitted on board. If a reduction of more than 10% of the charged weight stamped on the container is found, the fire-extinguisher shall be recharged.

3.2 Powder fire-extinguishers charged with nitrogen or CO₂

The functioning of the pressure gauge shall be checked. Furthermore, it shall be checked that the correct pressure is indicated by the pressure gauge at normal temperatures. If the pressure is below the normal range stamped on the pressure gauge, the fire-extinguisher shall

be recharged. In connection with the pressure tests prescribed under regulation 4, the powder charge shall be replaced.

3.3 Cartridge-driven powder, water and foam fire-extinguishers

3.3.1 The cartridge, etc. shall be removed, and the charge shall be replaced by a new one.

However, powder charges shall not be replaced if it can be proved in an effective way that the powder is “easy-flowing” and absolutely dry.

3.3.2 The cartridge shall be cleaned, and its weight shall be checked. If a reduction of more than 10% of the weight stamped on the cartridge is not found, the cartridge may be reused. In connection with the pressure tests prescribed in paragraph 4, the cartridge shall be replaced by a new one.

3.4 Common to the fire-extinguishers mentioned in paragraphs 3.1, 3.2 and 3.3

3.4.1 The container shall be inspected for external deformities and any external corrosion.

The container for the fire-extinguishers mentioned in paragraph 3 shall also be inspected on the inside. If any corrosion is found, it shall be removed, and the container shall be repainted. In case of considerable external deformities and/or massive external corrosion, the container shall be either discarded or pressure-tested and inspected on the inside in pursuance of regulation 4 with a satisfactory result.

3.4.2 Valve and hose, etc. shall be undamaged. Any damaged parts shall be replaced. It must be carefully checked that air can flow free. In connection with any replacement of damaged parts, the following shall be complied with:

3.4.2.1 Packings shall be made of rubber resistant to oil, weather and aging and of a good quality or of another material with similar properties.

3.4.2.2 Hoses shall have an appropriate length and be made of rubber resistant to oil, weather and aging and of a good quality or of another material with similar properties.

3.4.2.3 Hoses with associated fittings for CO₂ fire-extinguishers shall be able to resist a test pressure of 25 N/m² and other types of fire-extinguishers shall be able to resist twice the operating pressure.

3.4.3 It shall be checked that the instruction manual for the fire-extinguisher is undamaged and easily legible. If not, it shall be replaced.

3.4.4 When the inspection has been carried out, the operating handle of the fire extinguisher shall be sealed, and an inspection label shall be affixed firmly to the fire-extinguisher stating:

3.4.4.1 The month and year of the latest annual inspection;

3.4.4.2 The name and address of the person or the company which has carried out the inspection, cf. paragraph 1.3 above.

4. Periodical pressure tests, etc.

4.1 CO₂ fire-extinguishers

4.1.1 Containers for CO₂ fire-extinguishers shall be cleaned and inspected internally as well as pressure-tested every ten years. The test pressure shall be 20 N/mm² or 25 N/mm² depending on the test pressure stamped on the container.

4.1.2 If more than five years have passed since the latest pressure test, a discharged CO₂ fire-extinguisher may not be recharged until a new pressure test has been carried out with a satisfactory result.

4.2 Fire-extinguishers charged with nitrogen or CO₂

4.2.1 Containers for pressure-charged fire-extinguishers shall be cleaned and inspected internally as well as pressure-tested every ten years. The test pressure shall be 1.5 times

the pre-charged pressure, however not below 1 N/mm², cf. the test pressure stamped on the container.

4.2.2 If more than five years have passed since the latest pressure test, a charged fire extinguisher may not be recharged until a new pressure test has been carried out with a satisfactory result.

4.3 Cartridge-driven powder, water and foam fire-extinguishers

4.3.1 Containers for cartridge-driven fire-extinguishers shall be cleaned and inspected internally as well as pressure-tested every five years. The test pressure shall be 1.5 times the operating pressure, however not below 1 N/mm², cf. the test pressure stamped on the container.

4.4 Common to the fire-extinguishers mentioned in paragraphs 4.1, 4.2 and 4.3

4.4.1 All pressure tests shall be carried out hydraulically by the chief engineer of the ship (only on board ships where a certificate of competency as a chief engineer officer is required in pursuance of the STCW Convention, chapter III, regulation III-2), and it shall be carefully checked that the container is completely filled with liquid. The test pressure shall be constant for at least 15 seconds, and the containers may show now signs of leakage or permanent deformity. After the pressure test, the container shall be carefully dried.

4.4.2 The month and year of the pressure test shall be stamped on the container in a durable way.

**Notice from the Danish Maritime Authority B –
The Construction and Equipment, etc. of Ships**

Chapter B II-3

Accommodation etc.¹⁾

<i>Regulation 1 – Definitions</i>	<i>1</i>
<i>Regulation 2 – Application</i>	<i>2</i>
<i>Regulation 3 – Approval and surveys</i>	<i>2</i>
<i>Regulation 4 – Exemptions and equivalents</i>	<i>3</i>
<i>Regulation 5 – Location, construction and arrangement</i>	<i>4</i>
<i>Regulation 6 – Ventilation, air-conditioning and mosquito nets</i>	<i>5</i>
<i>Regulation 7 – Heating</i>	<i>6</i>
<i>Regulation 8 – Lighting.....</i>	<i>7</i>
<i>Regulation 9 – Sleeping rooms: Location, size, arrangement, etc.</i>	<i>7</i>
<i>Regulation 10 – Berths.....</i>	<i>9</i>
<i>Regulation 11 – Lockers for work clothes</i>	<i>9</i>
<i>Regulation 12 – Dining rooms</i>	<i>10</i>
<i>Regulation 13 – Recreation rooms.....</i>	<i>11</i>
<i>Regulation 14 – Toilets and bathrooms</i>	<i>11</i>
<i>Regulation 15 – Separate toilets and changing rooms</i>	<i>12</i>
<i>Regulation 16 – Laundry rooms, etc.</i>	<i>13</i>
<i>Regulation 17 – Headroom in accommodation, etc.</i>	<i>13</i>
<i>Regulation 18 – Corridors, staircases and doors</i>	<i>14</i>
<i>Regulation 19 – Galleys and provision stores</i>	<i>14</i>
<i>Regulation 20 – Drinking water systems</i>	<i>15</i>
<i>Regulation 21 – Infirmary and hoist stretcher.....</i>	<i>16</i>
<i>Regulation 22 – Offices.....</i>	<i>18</i>
<i>Regulation 23 – Cleaning and inspection</i>	<i>18</i>
<i>Regulation 24 – Exits</i>	<i>18</i>
<i>Regulation 25 – Passenger accommodation, etc.</i>	<i>19</i>
<i>Regulation 26 – Location.....</i>	<i>19</i>
<i>Regulation 27 – Determination of the number of passengers in individual rooms</i>	<i>19</i>
<i>Regulation 28 – Toilets</i>	<i>20</i>
<i>Regulation 29 – Hospital</i>	<i>20</i>
<i>Regulation 30 – Persons with reduced mobility</i>	<i>21</i>

Part I – Definitions, etc.

Regulation 1 – Definitions

For the purposes of this chapter, the following definitions shall apply:

¹⁾ Parts I and II of this chapter include provisions implementing ILO Convention no. 92 of 18 June 1949 and no. 133 of 30 October 1970 on the accommodation of crews.

1. *“New ship” is a ship the keel of which is laid or which is at a similar stage of construction on or after 1 January 2002.*
2. *“Existing ship” means a ship which is not a new ship.*
3. *“Passenger ship” means a ship which carries more than 12 passengers.*
4. *“Cargo ship” means any ship which is not a passenger ship or fishing vessel.*
5. *“Officer” means any person, apart from the master, who is deemed an officer under legislation, collective agreements or custom.*
6. *“Accommodation (Living quarters)” means such sleeping rooms, dining rooms, toilets and bathrooms, sickbays, recreational spaces and offices as are provided for the use of the crew and passengers.*
7. *“Ship’s crew or crew” means any person serving on board the ship, apart from the master.*
8. *“Adult” means a person who is at least 18 years of age.*
9. *“Seagoing ship” means a ship for which the area of navigation is not restricted to port areas.*
10. *“Port area” means an area other than a sea area extending to the outermost permanent harbour works forming an integral part of the harbour system, or to the limits defined by natural geographical features protecting a(n) river mouth /estuary or similar sheltered area.*
11. *“Gross tonnage” means the gross tonnage (GT) measured in accordance with provisions in force concerning the tonnage measurement of ships. In the case of ships with a length of 24 metres and above, in accordance with the International Convention of Tonnage Measurement of Ships, 1969.*

Regulation 2 – Application

1. *The provisions of this chapter shall apply to new cargo ships with a length (L)²⁾ of 15 m or above or with a scantling number (cf. definition in chapter B I) of 100 or above and to passenger ships engaged on international voyages with a gross tonnage of 20 or above.*
2. *Existing ships shall, insofar as is deemed reasonable given their arrangement, be made to meet the provisions of this chapter when they undergo major alterations or when structural alterations are made which lead to material changes in the size of the ship’s crew.*

Regulation 3 – Approval and surveys

1. *For all new ships, drawings as well as information about the ship’s service area and expected gross tonnage as well as the number of crew members and passengers, if any, and their distribution by category shall be forwarded to the Danish Maritime Authority for approval, etc. The drawings shall show the location, size and arrangement of the accommodation, the utilisation of the space, the placing of furniture and accessories as well as the arrangement of heating, ventilation, exits, etc.*
2. *Equivalent drawings and information shall be submitted to the Danish Maritime Authority before the accommodation in an existing ship undergoes alterations or modifications.*

²⁾ *“Length (L)” shall be taken as 96% of the total length on a waterline at 85% of the least moulded depth measured from the keel line, or as the length from the foreside of the stem to the axis of the rudder stock on that waterline, if that be greater. In ships designed with a rake of keel, the waterline on which this length is measured shall be parallel to the designed waterline.*

3. *A complete survey of the accommodation, etc. shall be carried out before the ship is put into service.*
4. *Depending on the circumstances, either a complete or a partial survey shall be carried out following major repairs or alterations involving considerable changes to the accommodation.*
5. *The Danish Maritime Authority or an organisation authorised by the Danish Maritime Authority may, at any time, carry out an unannounced inspection of the accommodation on board.*

Regulation 4 – Exemptions and equivalents

1. *Taking into consideration the special circumstances that apply to each individual ship and following negotiations with the relevant shipowner and crew organisations, the Danish Maritime Authority may allow deviations from the provisions of this chapter concerning the crew accommodation in respect of the following:*
 - 1.1. *Ferries or similar ships not constantly manned with a permanent crew.*
 - 1.2. *The accommodation, etc. intended for repair personnel or special personnel when these persons are temporarily carried in addition to the ship's crew.*
 - 1.3. *Ships engaged on short voyages that allow the crew members to go home or make use of equivalent possibilities for part of the day.*
 - 1.4. *Ships for special purposes, such as cable-laying ships, factory ships and the like, with a need for considerable special personnel in addition to the ship's crew as such.*
2. *Furthermore, following the negotiations referred to in paragraph 1, the Danish Maritime Authority may allow deviations from the provisions of regulations 5 to 11, 13 to 16, 18 to 22, 26 and 28 when conditions otherwise indicate this in consideration of the special circumstances of each individual ship.*
3. *In ships with a gross tonnage below 250, the Danish Maritime Authority may allow deviations from the provisions when conditions otherwise indicate this in consideration of the special circumstances of each individual ship.*
4. *In ships where it is, during manning and without any differential treatment, necessary to take consideration of conditions of importance to crews with different specific religious and social customs and practices, the Danish Maritime Authority may, following negotiations with the shipowner and crew organisations of the relevant seamen and subject to agreement between the said two parties, allow deviations from the provisions of regulations 9.1.3, 9.3, 9.5 and 14.2, provided that such deviations do not mean that the facilities as a whole become less appropriate than they would have been had the provisions of the technical regulation been applied.*
5. *Equivalents*
 - 5.1. *Any provision of part II of this chapter may be departed from if, following negotiations with the relevant shipowner and crew organisations, the Danish Maritime Authority is satisfied that such deviations would result in such advantages that the conditions as a whole are not less favourable than they would have been had the provisions been applied in full.*

Part II – Crew accommodation

Regulation 5 – Location, construction and arrangement

- 1.1. *The location, conditions of access, construction and placing in relation to other rooms shall be such as to provide sufficient safety, protection against weather and sea, insulation from heat, cold and noise pollution and air pollution from other rooms³⁾.*
- 1.2. *The accommodation shall be located as far as seems reasonable from rooms in which substantial noise occurs, such as rooms for main machinery, auxiliary machinery, steering gear and deck machinery, and from rooms in which strong heat or cold may occur; neither shall it be located directly above the propeller.*
- 1.3. *Direct access to sleeping rooms shall not be provided from the rooms mentioned in paragraph 1.2 or from cargo spaces, galleys, chain lockers, lamp rooms, paint stores, stores rooms, drying rooms, laundry rooms and toilets intended for more than two persons. Bulkheads separating such rooms from sleeping rooms as well as external bulkheads to accommodation spaces shall be made of steel or another approved material and shall be watertight and gas-tight; furthermore, they shall be adequately insulated both against noise and heat and cold.*
- 1.4. *Direct access shall not be provided from galleys and dining rooms to toilets and bathrooms.*
2.
 - 2.1. *The accommodation and corridors leading to the accommodation shall be insulated against heat transmission from the casing, galleys and other rooms in which heat may arise as well as against heat transmission from steam and hot water pipes and against effects from rooms that are cooled.*
 - 2.2. *Internal bulkheads shall be made of an approved, sound-insulating material that does not represent a risk in respect of vermin.*
 - 2.3. *Sleeping rooms, dining rooms, recreation rooms and corridors in the crew accommodation shall be insulated to prevent condensation or overheating.*
3. *Main steam pipes and return steam pipes for winches and similar machinery shall not be carried through the accommodation or through corridors leading to the accommodation.*
4.
 - 4.1. *The internal panelling or internal wall coverings shall be made of a material with a surface that is easy to keep clean.*
 - 4.2. *Planed off and matched boards or any other kind of construction that may involve a risk of vermin shall not be used.*
5. *Each accommodation section shall have at least two exits.*
6.
 - 6.1. *Ceilings and bulkheads in the accommodation shall be easy to keep clean and, if they have been painted, they shall be kept in light colours and shall be renewed or repaired*

³⁾ Reference is made to Notice A from the Danish Maritime Authority, chapter III, part B-1 on noise in ships, which applies to all commercial work on board new and existing ships.

when necessary. Pipes, cables and ducts shall be covered with lining sheets as far as possible.

- 6.2. *In all accommodation spaces, the floor shall be of an approved material and design, and the surface shall be impervious to moisture and easy to keep clean.*
7. *The transition between the bulkhead/wall panelling and the floor shall not have cracks.*
8. *Sufficient drainage shall be provided for water from both condensation and fire fighting. In corridors and large spaces, it shall be possible for water from fire fighting to be quickly drained off.*

Regulation 6 – Ventilation, air-conditioning and mosquito nets

1.

- 1.1. *The accommodation and corridors leading to other rooms in the accommodation as well as workrooms where the crew are to carry out work for longer periods of time, e.g. radio rooms and engine control rooms, shall be ventilated so that a sufficient exchange of air is ensured under all circumstances when doors, side scuttles, skylights and the like are closed. The same applies to navigation rooms.*
- 1.2. *If the exchange of air takes place exclusively through natural ventilation, the inlet and outlet openings shall have a clear flow area of at least 30 cm² for every person for which the room is intended.*

2.

- 2.1. *In ships with a gross tonnage of 200 or more, the ventilation shall be mechanical and the exchange of air shall comply with the following requirements:*
 - 2.1.1. *The ventilation of sleeping rooms, dining rooms, recreation rooms, offices, radio rooms, navigation rooms and equivalent workrooms shall be effected by means of the blowing in of air equivalent to six air changes per hour.*
 - 2.1.2. *The outlet of air may take place via air gratings in the doors to corridors provided with a return air duct or directly to the open air.*
 - 2.1.3. *Recirculation of up to 50 per cent of the air supply may be permitted on the condition that toilets and bathrooms are provided with separate mechanical extraction. The supply of fresh air to sleeping rooms shall, however, be at least 30 m³ per hour for each person for which the room is intended.*
- 2.2. *The inlet openings shall be placed appropriately, relative to the arrangement of the rooms and may not give rise to bothersome draughts over a berth.*

3. *In ships with a gross tonnage of 200 or more, toilet rooms and bathrooms shall be ventilated by a separate extraction system leading directly to the open air. The extraction system shall be designed for ten air changes per hour. The air supply to toilet rooms and bathrooms with access from adjoining sleeping rooms may take place through the door there from.*

A common extraction system from accommodation spaces and toilets where the air is led to the open air through a heat exchanger is acceptable if it can be documented that the ventilation with a common duct and heat exchanger without the reuse of air is equivalent to a separate extraction system.

4. *The galley shall be ventilated by a separate extraction system. An exhaust hood with a vent pipe leading to the open air shall be fitted above the cooking stove.*

5. *The ventilation system shall be constantly switched on during the operation of the ship. Maintenance of the mechanical ventilation shall be ensured by means of the necessary spare parts⁴⁾ or in some other satisfactory way.*
6. *In infirmaries and special changing rooms on board ships carrying dangerous substances, the ventilation shall be constructed so that air from the said rooms cannot penetrate into other parts of the accommodation. Doors to corridors leading to other parts of the accommodation may not be provided with ventilation openings and any ventilation ducts shall be provided with a non-return flap, or else other arrangements shall be put in place to ensure that the air does not penetrate into the rest of the accommodation.*
7. *Ships regularly engaged in trade between 30° N and 30° S shall be equipped with air conditioning in sleeping rooms, living spaces, infirmaries, dining rooms, recreation rooms, offices, radio rooms, navigation rooms, including the wheelhouse, as well as in engine control rooms.*
8. *The air-conditioning system may be a central system or consist of separate units and shall be designed so that, at 35° C and 70 per cent relative humidity outside, it can maintain 29° C and about 50 per cent relative humidity inside. No more than 50 per cent return air may be used.*
9. *Furthermore, the cooling machinery and air coolers of the system shall be designed so that, at 28° C and 80 per cent relative humidity outside, they can maintain 24° C and about 50 per cent relative humidity inside. It shall be possible to achieve such conditions with the quantities of fresh air mentioned in paragraph 2.1.*
10. *Ventilation and air-conditioning systems shall be provided with appropriate filters at air inlets and shall be designed for the special conditions characteristic of operation at sea and may not cause noise nuisance or vibrations.*
11. *Mosquito nets.*
 - 11.1. *In ships regularly calling at mosquito-plagued ports, measures shall be taken to protect the accommodation from the penetration of mosquitoes by placing suitable nets in front of side scuttles, ventilators and doors to the open air.*
 - 11.2. *Ships provided with air-conditioning systems meeting the requirements of paragraphs 7 to 10 shall be exempted from meeting the requirement for mosquito nets.*

Regulation 7 – Heating

1.
 - 1.1. *A suitable heating system for the accommodation shall be fitted in all ships.*
 - 1.2. *The heating system shall constantly be switched on during the operation of the ship when circumstances necessitate its use. The capacity shall be sufficient to maintain a room temperature of at least 20° C under all circumstances.*
2. *In ships with a gross tonnage above 100, heating by means of naked flames shall not be permitted.*

⁴⁾ *The following spare parts shall be considered necessary as a minimum:*

- 1) *One spare motor for each type of motor in the ventilation systems.*
- 2) *One set of extra bearings for each type of motor both in the ventilation and the air-conditioning systems.*
- 3) *One set of extra bearings for the ventilator, where this is driven by a belt drive from a motor.*
- 4) *100 per cent spare stock of air filters.*
- 5) *One set of V-belts of each type.*
- 6) *One spares box containing special tools, small spare parts and O-rings.*

3. Radiators and other heating systems shall be arranged and shielded so that they do not represent a danger or inconvenience.
4. Electric heaters and gas heaters shall be of an approved type.

Regulation 8 – Lighting

1. The accommodation shall be properly lit.
2. Sleeping rooms, living spaces, dining rooms, recreation rooms and infirmaries shall be lit by daylight. This need not, however, apply to hobby rooms and similar rooms. The supply of daylight shall be sufficient to read ordinary newsprint in clear weather anywhere in the room where persons may normally be. On passenger ships, however, special arrangements may be permitted.
3. In all ships, the accommodation shall be provided with electric lighting arranged so that it offers the greatest possible benefit to the persons in the room. In sleeping rooms, an electric reading lamp shall be fitted at the head of each berth.
4. The following guidelines are laid down as to the luminous power that shall be considered suitable for artificial lighting:
 - 4.1. Sleeping rooms and separate day rooms:
 - a) General lighting 50 lux
 - b) Lighting at tables where reading and writing take place 200 lux
 - 4.2. Dining rooms and recreation rooms:
 - a) General lighting 50 lux
 - b) Lighting on dining tables 150 lux
 - c) Lighting on tables where reading writing and game-playing etc. take place 200 lux
 - 4.3. Bathrooms and toilets:
 - a) General lighting 50 lux
 - b) At mirrors 200 lux
 - 4.4. Corridors and staircases:
 - a) General lighting 50 lux

In other rooms not mentioned here and as equivalence to the luminous powers mentioned above, the luminous powers recommended by the Danish Standards Association⁵⁾ may be used.

5. The general lighting is measured at a horizontal plane 0.85 m above floor level.

Regulation 9 – Sleeping rooms: Location, size, arrangement, etc.

1.
 - 1.1. Sleeping rooms shall be located amidships or aft, and no part of a sleeping room may be located below the highest load line mark or the highest operating waterline on ships not provided with load line marks. Under no circumstances may living quarters be located fore of the collision bulkhead or below corridors in which work causing noise nuisance is regularly carried out.

⁵⁾ Reference is made to DS 700, Artificial lighting in work premises.

1.2. *In special cases, if the size, type or use of the ship makes the location of the sleeping rooms amidships or aft inappropriate, permission may be given to place them further forward, but never in front of the collision bulkhead. In passenger ships, permission may be given to locate sleeping rooms partly below the highest load line mark on condition that there is satisfactory lighting and ventilation. In new ro-ro passenger ships, passenger cabins may not be placed below the ro-ro deck (the bulkhead deck). Furthermore, reference is made to the requirements on escape routes in chapter II-2, regulation 13.*

In ships with a gross tonnage below 250 built for special purposes, such as tug/tow-boats, permission may be given to locate sleeping rooms partly below the deepest operating waterline on condition that there is satisfactory lighting and ventilation.

1.3. *The floor area in sleeping rooms shall have at least the following size:*

<i>Gross tonnage of ship</i>	<i>Minimum floor area (m²)</i>				
	<i>Cargo ships</i>		<i>Passenger ships</i>		
	<i>1 person</i>	<i>2 persons</i>	<i>1 person</i>	<i>2 persons</i>	<i>3 persons</i>
<i>20 – 499</i>	<i>3.00</i>	<i>4.00</i>	<i>3.00</i>	<i>4.00</i>	<i>6.00</i>
<i>500 – 999</i>	<i>3.50</i>	<i>4.50</i>	<i>3.00</i>	<i>4.00</i>	<i>6.00</i>
<i>1,000 – 2,999</i>	<i>3.75</i>	<i>5.50</i>	<i>3.75</i>	<i>5.00</i>	<i>7.00</i>
<i>3,000 – 9,999</i>	<i>4.25</i>	<i>6.50</i>	<i>3.75</i>	<i>6.00</i>	<i>9.00</i>
<i>10,000 and above</i>	<i>4.75</i>	<i>7.50</i>	<i>3.75</i>	<i>6.00</i>	<i>9.00</i>

1.4. *Sleeping rooms for officers shall have a floor area of at least 6.50 m² in ships with a gross tonnage below 3000 and of 7.50 m² in ships with a gross tonnage of 3000 or more.*

1.5. *The floor area taken up by fixed furniture such as berths, lockers, chests of drawers, tables and benches shall be included in the floor area mentioned above. Small⁶⁾ or inappropriate areas that are not available for free movement and that cannot be used for placing furniture shall not be included.*

2. *In ships of 3000 tons or more, the chief engineer and the chief mate shall, in addition to their sleeping rooms, have an adjoining dayroom or living room.*
3. *In cargo ships, the number of persons in a sleeping room may not exceed two, and in passenger ships this number may not exceed three.*
4. *Each officer shall have his own sleeping room.*
5. *In ships with a gross tonnage of 500 or more, apart from passenger ships, each adult member of the crew shall have a separate sleeping cabin.*
6. *All sleeping rooms shall be arranged and equipped so that they provide the crew with reasonable comfort and are easy to keep tidy.*
7. *The furniture shall consist of the following, as a minimum:*

⁶⁾ *Of less than 0.6 x 0.6 m.*

- 7.1. *A wardrobe with a shelf and hanging rail for each person for which the room is intended. The wardrobe shall have a height of at least 1.50 m to the underside of the shelf, and the cross-sectional area shall be at least 0.193 m².*
- 7.2. *A table and seats for the number of persons for which the room is intended.*
- 7.3. *Drawers or the like with a capacity of at least 0.10 m³ for every person for whom the room is intended.*
- 7.4. *A mirror, small lockers for toiletries, a bookshelf and a suitable coat-hook arrangement.*

At least one locker or drawer for each person shall be lockable with an individual key.

- 8. *Side scuttles in sleeping rooms shall be provided with curtains.*
- 9. *Each sleeping cabin shall be clearly marked inside with the number of persons for which it is intended and for which it has been approved.*
- 10. *It shall be specified outside the room, either on or next to the door, for whom the cabin is intended.*
- 11. *Exits to the open deck shall be well protected and, in ships with a gross tonnage of 100 or more, exits from sleeping rooms may not solely lead only to the open deck.*

Regulation 10 – Berths

- 1. *Each crew member shall have a separate berth.*
- 2. *The internal dimensions of a berth shall be at least 1.98 m x 0.80 m.*
- 3. *Berths may not be placed immediately next to each other.*
- 4. *More than two berths may not be placed on top of each other. The distance between the bottoms of the berths as well as between the bottom of the top berth and the underside of the ceiling panelling shall be at least 0.75 m. The bottom of the berth shall be at least 0.30 m above the floor.*
- 5. *As far as possible, berths may not be located along the side of the ship. Where necessary in exceptional cases, there may only be a single berth if there is a sidescuttle above the berth.*
- 6. *The berths shall be made of wood or another material that is hard, smooth, corrosion-free and which does not represent a risk of vermin. If tubes are used, they shall be completely sealed so that they cannot provide living space for vermin.*
- 7. *The berths shall be provided with spring mattresses or a spring bottom and mattresses of a generally recognized type. The mattresses may not contain material in which vermin could live.*
- 8. *Top berths shall be provided with a base of wood or another suitable dust-tight material.*

Regulation 11 – Lockers for work clothes

- 1. *Ships with a gross tonnage of 75 or more shall provide one or more well-ventilated lockers of a suitable size and arrangement for work clothes, oil clothes, sea boots and the like, outside the sleeping rooms.*

Regulation 12 – Dining rooms

1. *In ships with a gross tonnage of 500 or more, separate dining rooms shall be provided for officers and deck and engine crew. In ships with a gross tonnage below 250, the galley may be used as a dining room for the crew.*
2. *In ships with a gross tonnage of 3000 or more, separate dining rooms shall also be available for the catering and serving staff if their number exceeds four.*
3. *The provisions of paragraphs 1 and 2 may be departed from if discussions with the relevant shipowner and crew organisations have concluded that other arrangements are preferable. An agreement has been reached with the said organisations on a practice and a system of equivalents as regards the use of joint dining rooms on board cargo ships⁷⁾.*
4. *In ships where no separate dining room is required, tables and seats shall be located in the galley or in another suitable place where the crew can eat, and suitable storage arrangements shall be available for provisions and eating utensils.*
5. *Dining rooms shall be conveniently located in relation to sleeping rooms and galleys.*
6. *The floor area in dining rooms shall be at least 1.0 m² for each person who is to use the room. When the floor area is calculated, the space taken up by dining tables, benches and chairs may be included.*
7. *Dining rooms shall be equipped with tables and approved fixed or loose seats in such a number that the crew members for whom the room is intended can eat their meals at the same time. On ships carrying special personnel for repairs and the like, it may be accepted that they do not eat at the same time as the crew. There shall be at least 0.6 m of table space for each seat at the tables.*
8. *The necessary lockers for the storage of tableware shall be provided, and such facilities as are required to clean the tableware shall be provided outside the dining room(s).*
9. *The surfaces of tables and seats shall be easy to clean and resistant to cracks and damp.*
10. *On ships with a gross tonnage of 250 or more, there shall at all times be:*
 - 10.1. *access to appropriately placed cooling equipment with a capacity corresponding to the number of persons using the dining room(s). The capacity shall be at least 10 l per person for up to ten persons, and 5 l per person for each additional person;*
 - 10.2. *facilities for getting hot drinks; and*
 - 10.3. *facilities for getting chilled drinking water.*
11. *The Danish Maritime Authority may allow such deviations from the provisions of paragraphs 4 to 7 on dining rooms as are necessary with regard to the particular conditions on board passenger ships.*

⁷⁾ *If a joint dining room (mess room) is provided on board cargo ships with a gross tonnage of or above 500 for officers, deck and engine staff as well as catering and serving staff, at least one joint “duty mess” shall also be provided, and in ships with a gross tonnage of 3000 or more a smoking room shall also be provided. For the time being, details of such arrangements shall, for each cargo ship or the first ship in a series of sister ships aiming to have a joint dining room, be forwarded to the 3F, Fælles Fagligt Forbund (United Federation of Danish Workers) and to Søfartens Ledere (Danish Maritime Officers) for comments. For the time being, details of equivalent arrangements on passenger ships shall be forwarded to all the relevant shipowner and crew organisations for comments.*

Regulation 13 – Recreation rooms

1. *In ships with a gross tonnage of 250 or more, one or more places shall be set up on open deck to which the crew has access to in their spare-time. Such space(s) shall be of a suitable size in consideration of the size and arrangement of the crew and the ship. Ships regularly engaged on voyages between 30° northern latitude and 30° southern latitude and in the Persian Gulf, the spaces shall be provided with awnings or other cover.*
2. *In ships with a gross tonnage of 250 or above, but below 8000, appropriately located and suitably equipped rooms intended for the crew to spend their spare time in shall be provided. The furniture in such rooms shall include a bookcase as well as furniture providing the opportunity to read, write and play games.*
3. *In ships of a gross tonnage below 1000, such rooms may be dispensed with, provided that the dining room(s) are of such a size and are furnished and arranged in such a way that they are suitable for the passing of spare time. The total floor area shall be at least twice the required area of a dining room.*
4. *In ships with a gross tonnage of 1000 or above, it shall be examined whether there is a possibility of setting up a canteen when the recreation and dining rooms are planned.*
5. *In ships with a gross tonnage of 8000 or above, a smoking room or reading room shall be provided; there shall also be a room for other recreational activities, including exercises and other physical activities. In one of the rooms, it shall be possible to watch films or television.*
6. *In ships with a gross tonnage of 8000 or above, a swimming pool shall be provided if the Danish Maritime Authority considers that it would be reasonable and possible.*

Regulation 14 – Toilets and bathrooms

1. *In all ships, toilets and bathrooms shall be conveniently situated in relation to sleeping rooms and other parts of the accommodation.*
2. *In all ships with a gross tonnage of 250 or above, there shall be at least one toilet and one shower for every six persons or fewer in each of the groups of officers and other crew members, disregarding persons who have their own bathroom adjoining their sleeping cabin with a washbasin, shower and toilet. Where female staff serves on board, they shall have separate toilets and bathrooms.*
3. *Regardless of the stipulations of paragraph 2, there shall be at least the following number of separate toilets, including the separate toilets required under regulation 15:*
 - 3.1. *In ships with a gross tonnage of 500 or above, but below 800: three.*
 - 3.2. *In ships with a gross tonnage of 800 or above, but below 3000: four.*
 - 3.3. *In ships of 3000 tonnes gross tonnage or above: six.*
4. *In ships with a gross tonnage of 75 or above, the toilets shall be provided with adequate flushing facilities and drainage. Both flushing facilities and drainage shall be properly fitted out and ensured for all climatic conditions and always be ready for use whilst the ship is in operation. All toilets shall be provided with a washbasin with running hot and cold fresh water.*
5. *All bathrooms shall be provided with at least one shower for every six persons or fewer and one washbasin for every three persons or fewer for whom the room is intended. Washbasins shall be of a suitable size and shall be made of stainless steel, porcelain or another approved material.*

6. *In ships with a gross tonnage of 5000 or above, each officer shall have a separate bathroom provided with toilet, shower and washbasin with running hot and cold fresh water adjoining his or her sleeping rooms.*
7. *In ships with a gross tonnage of 25000 or above, except for passenger ships, at least one bathroom shall be provided for every two members of the rest of the crew. The bathroom shall be located either opposite the entrance to the rooms to which the bathroom belongs or in some other convenient location.*
8. *An adequate supply of hot and cold fresh water shall be provided in all bathrooms.*
9. *Toilets and bathrooms shall otherwise meet the following requirements:*
 - 9.1. *The floor shall be made of an approved and durable material that is easy to clean, impervious to water, non-slip and provided with the necessary drainage, though floor drainage shall not be required in separate toilets.*
 - 9.2. *The bulkheads shall be tight and made of steel or another approved material and shall be impervious to water.*
 - 9.3. *The rooms shall be properly lit and heated. Bathrooms shall have separate heating if they are not surrounded by heated rooms on all sides or if adequate heating is secured by other means.*
 - 9.4. *If intended for more than two persons, shared toilets shall be separate from sleeping rooms and bathrooms. Direct access may not be provided from sleeping rooms to toilets or bathrooms intended for more than two persons.*
 - 9.5. *Toilets shall be sufficiently screened from each other.*

Regulation 15 – Separate toilets and changing rooms

1. *In ships with a gross tonnage of 250 or above, a separate toilet with a washbasin with running hot and cold fresh water shall be provided conveniently close to the navigation bridge.*
2. *In ships with a gross tonnage of 1000 or above, a toilet with a washbasin with running hot and cold fresh water shall be provided conveniently close to the engine room if one has not been installed close to the engine control room.*
3. *In ships with a gross tonnage of 1000 or above, except for ships where one-man or two-man bathrooms are provided for the crew in the engine section, changing rooms for the crew employed in the engine room shall be provided outside the engine room but with easy access and provided with wardrobes for each crew member and with washbasins and showers with running hot and cold fresh water.*
4. *Changing rooms in ships carrying dangerous substances.*
 - 4.1. *In all new ships approved to carry carcinogenic substances in bulk (e.g. crude oil, petrol, benzene, vinyl chloride, butadiene, etc.), separate bathrooms and changing rooms shall be provided if it is assessed, cf. regulation 6 of Notice A from the Danish Maritime Authority, chapter A II C, that there is a risk of work clothes being contaminated. Carcinogenic substances and materials shall mean those mentioned in Notice A from the Danish Maritime Authority, chapter A II C, Annex 1. Furthermore, it shall either be possible, in a reasonable manner, either to collect and pack work clothes in containers for laundry ashore or else laundry facilities shall be provided on board for work clothes. If disposable clothes or equipment is used, closed, suitable waste containers shall be available for this purpose.*

- 4.2. *Special bathrooms and changing rooms shall be divided into a changing room for work clothes and one for general clothes with bathing facilities between the two rooms.*
- The room for work clothes may be used as a changing room only by the part of the crew who has been contaminated. The room for general clothes may be used as a changing room only by the part of the crew who has not been contaminated.*
- 4.3. *There shall be direct access from open deck to special bathrooms and changing rooms for contaminated work clothes.*
- 4.4. *A toilet with a washbasin shall be provided in connection with the changing room.*
- 4.5. *Bathrooms shall be provided with showers and washbasins with hot and cold water and be arranged as stipulated in regulation 14.5.*
- 4.6. *Bathrooms and changing rooms for work clothes may not be intended for use by persons other than those exposed to the contamination in question.*
- 4.7. *Changing rooms shall be provided with lockers for everyone who is to use the rooms. The lockers shall be made of a suitable material that is easy to clean and they shall be provided with ventilation apertures, top and bottom.*
- 4.8. *When separate laundry facilities are set up for laundering the said work clothes on board, cf. paragraph 4.1, they shall be equipped with a washing machine and a drying machine or drying rooms of sufficient capacity. The laundry facilities for such work clothes may not be used for other clothes.*
- 4.9. *In existing ships approved to carry carcinogenic substances in bulk, the requirements for the special bathing and changing facilities should be met operationally. In most cases, this would be by dividing the changing room into a clean section and a dirty one, such as by means of markings on the floor.*

Regulation 16 – Laundry rooms, etc.

1. *In ships with a gross tonnage of 250 or above, rooms shall be provided for laundry of clothes with ample supply of hot and cold fresh water and with a possibility of drying and ironing clothes to the extent appropriate for the size of the crew and the normal duration of voyages.*
2. *The equipment shall include:*
 - 2.1. *Washing machines.*
 - 2.2. *Drying machines or appropriately heated and ventilated drying rooms.*
 - 2.3. *Irons and ironing boards or the like.*
3. *Laundry and drying rooms shall be situated conveniently in relation to the living quarters.*

Regulation 17 – Headroom in accommodation, etc.

In all accommodation spaces and corridors, the clear headroom measured from the top of the deck covering to the lower edge of the deck beams or their covering (the ceiling) shall be at least 1.98 m. If, for design reasons, there is a desire to make the headroom smaller than stipulated above at individual points in the rooms or in individual rooms for special use (saunas or the like), the Danish Maritime Authority may permit this if it is assessed that it will not cause inconvenience.

Regulation 18 – Corridors, staircases and doors

1. *In general, the breadth of corridors serving as entrances to accommodation spaces shall be at least 90 cm, measured between the divisional bulkheads.*
2. *Stairs shall in general have a breadth between the divisional bulkheads of 80 cm, possess a suitable inclination and be provided with handrails on at least one side.*
3.
 - 3.1. *Permission may be granted to place fire hose cabinets, ventilation ducts, cable tracks and the like on the divisional bulkheads in corridors and on staircases when it is considered not to cause inconvenience when passing. However, the room for free passage may not be less than 60 cm at any point.*
 - 3.2. *In short, enclosed corridors and associated staircases that are normally used by only one or two persons, permission may be granted to reduce the breadth provided that it is not less than 60 cm.*
4. *In general⁸⁾ doors⁹⁾ that provide access to shared accommodation, staircases and the like shall have a breadth that is not less than 90 cm on passenger ships and 80 cm on cargo ships, measured as the internal dimension of the doorframe.*
 - 4.1. *In general, doors that provide access to cabins and the like shall not have a breadth below 75 cm measured as the internal dimension of the doorframe.*
 - 4.2. *Doors leading to one-man cabins or usually to be used by only one person, shall, in general, have a breadth of 70 cm.*
 - 4.3. *In general, doors that provide access to toilets or bathrooms and the like shall not have a breadth below 60 cm.*
5. *On ships with a gross tonnage below 500 and ships for special purposes, the Danish Maritime Authority may accept deviations considering the space available on board; however, normally doorways of less than 60 cm will not be accepted.*
6. *The height of the doorway shall be at least 1.88 m above the deck covering.*

Regulation 19 – Galleys and provision stores

1. *In all ships, the cooker shall be located in a separate room, which may, however, also be used as a crew dining room in ships with a gross tonnage below 250.*
2. *The room shall have a suitable size and be well lit and ventilated. A hood with a vent pipe leading to the open air shall be fitted above the cooking stove.*
3. *The cooking stove shall be properly set up and secured. Any woodwork shall be protected against catching fire.*
4. *In the galley, fresh water shall be supplied by means of a pipe system. No seawater tap shall be located in this room.*

⁸⁾ *In this connection, the term “in general” shall be interpreted such that a minus deviation may be acceptable from the internal dimensions of approximately 5 per cent of the nominally stipulated breadth, except for doors to infirmaries and doors for use by handicapped persons on board passenger ships.*

⁹⁾ *Reference is also made to the fact that, in pursuance of chapter B II-2, regulation 13, “Means of escape”, mandatory requirements for the minimum size of joint means of access and means of escape apply as from 1 July 2002 in IMO’s “Fire Safety Systems Code” (the FSS Code), chapter 13. This is mandatory for all passenger ships and cargo ships with a gross tonnage of 500 or above, the keels of which are laid on or after 1 July 2002.*

5. *The galley shall be provided with the necessary sinks with drainage, and there shall also be drainage in the floor. The bulkheads and the floor shall be made of a material that is impervious to water and easy to keep clean. Furniture, lockers, tables and drawers shall be made of materials that are easy to clean and that are hygienic. Ordinary, joined wood of dressed and matched boards may not be used.*
6. *Suitable facilities shall be provided for the storage of provisions as well as for the refrigeration and freezing facilities of perishable foods.*

Regulation 20 – Drinking water systems

1. *Fixed drinking water tanks shall have a cofferdam separating them from tanks that may be used for other liquids, oil or the like. However, cofferdams may be dispensed with as separation from tanks intended for seawater. In riveted ships, the ship's side below the loaded waterline shall not form boundaries of a drinking water tank.*
2. *Drinking water tanks shall be fitted with the necessary manholes and shall, as far as possible, be accessible for both external and internal inspection. If their design and size do not permit access to the inside, they shall be provided with an adequate number of cleaning holes. Manholes and/or cleaning holes and their covers shall be designed so as to prevent the accumulation of impurities on top of the covers.*
 - 2.1. *Manhole covers and cleaning hole covers shall be fitted on frames that have a height of at least 50 mm and shall be marked "Drinking water tank".*
 - 2.2. *All steel in drinking water tanks shall be fully welded. All internal surfaces, including surfaces in smaller containers and the like, shall have a suitable finish approved by the Danish Maritime Authority, by other health authorities accepted by the Danish Maritime Authority or by recognised organisations in accordance with accepted standards.*
 - 2.3. *Pipes forming part of piping systems may not pass through drinking water tanks.*
 - 2.4. *It shall be possible to fully empty tanks, either by suction from the tank's lowest point or via a bottom screw.*
3. *Air pipes and filling pipes for tanks shall be carried to proper heights above deck, minimum 400 mm. The outlet of an air pipe shall be designed so that impurities cannot enter the tanks by this means. Filling pipes shall be provided with covers which it must not be possible to mistake for covers for tanks for other purposes.*
4. *Drinking water tanks shall be provided with standpipes or some other approved sounding device fitted such that it is not possible to introduce pollution to the water by this means. If sounding pipes for sounding rods/tapes have been fitted, the means of closing these shall be lockable, e.g. with a padlock, and they shall be marked "Drinking water tank".*
5. *For ventilation purposes, drinking water tanks shall normally be provided with at least two air pipes that shall be fitted with a fine-meshed net.*
6. *Pumps shall be of the membrane or centrifugal type or another suitable type that does not require lubrication of the parts that are in contact with the drinking water.*

7. *The pipe system may not be connected to other pipe systems in the ship, and only materials and components suitable for the purpose (e.g. those that have been VA-approved) may be used¹⁰⁾. If the pipelines to the drinking water system have been marked, such marking shall comply with the standardisation rules in force. Dead-end service pipes on main pipes shall be provided with a stop valve at the main pipe.*

If a sprinkler system is arranged so that it is capable of taking water only from freshwater tanks and/or the freshwater pipe system, it shall be ensured that the freshwater system cannot be contaminated by salt water.

Pipes that could be exposed to temperatures below 0°C shall be sufficiently insulated or otherwise protected against freezing. Pipes for drinking water may not pass through tanks intended for other liquids, with the exception of tanks for seawater.

8. *If fresh water generators and the like are installed, the sea suction from the fresh water generators and similar apparatuses shall be located clear of all drains from the ship.*
9. *When water has been put into the drinking water system, but before it is taken into use, a bacteriological analysis of drinking water samples from the system shall be carried out.*

The water samples, one of which shall be from the galley, shall be taken by a recognised laboratory (such as the Danish Food Inspectorate (Levnedsmiddelkontrollen)) and analysed by a recognised laboratory. The Danish Maritime Authority shall be guided in its decision on approval by the analysis report produced by the laboratory containing chemical and bacteriological analysis and a conclusion.

When a drinking water system has been found to be contaminated, disinfection shall be carried out in accordance with the guidance on disinfection during the cleaning of drinking water tanks and drinking water pipes on ships issued by the National Board of Health.

Regulation 21 – Infirmary and hoist stretcher

1. *In any ship engaged in more than limited trade or more than trade in the English Channel and around the British Isles, and where the number of crew members exceeds 12, a separate infirmary shall be set up. The infirmary shall contain at least one bed when the number of crew members is 18 or less and otherwise two beds.*
2. *In ships where each crew member has his or her own sleeping cabin with toilet and bath, a treatment room (casualty room) may be set up instead of the infirmary required under paragraph 1, such treatment room to be appropriately fitted out, including a washbasin and an emergency treatment area. One bed/examination couch in the treatment room shall suffice, irrespective of the size of the ship.*
3.
 - 3.1. *Infirmaries and treatment rooms shall be located in a suitable place where the inconvenience caused by noise and vibrations is as little as possible so that the patients may be given good conditions and be properly looked after in all kinds of weather.*
 - 3.2. *It shall be possible to enter the rooms in a convenient way with a person lying on a stretcher; the doorway shall be at least 75 cm wide.*

¹⁰⁾ “VA-approved” shall mean material that has been approved by the approval committee of the National Agency for Enterprise and Housing for use with water and drainage.

4.
 - 4.1. *The bed(s) shall be spaced out to provide accessibility from at least three sides. Bunk beds are not permitted.*
 - 4.2. *Next to each bed, there shall be a pushbutton with a wire connection ringing a bell located at a suitable place (a place that is normally manned) or another facility for calling help, such as an internal telephone.*
5. *A washroom with a toilet and a washbasin shall be located immediately next to the infirmary/treatment room with direct access there from. The washbasin shall be supplied with hot and cold fresh water.*
6. *In ships with a gross tonnage below 3000, the floor area in the infirmary/treatment room shall be at least 6.50 m² for every bed in the room, and in ships with a gross tonnage of 3000 or more, it shall be at least 7.50 m² for every bed.*
7. *The lighting in the infirmary/treatment room shall be variable, possibly through the installation of several fixed sources of light. The lighting at the beds shall, however, as a minimum, meet the standards for work lighting set out in regulation 8; in addition, a reading light shall be fitted at the bed(s) and a night light in the room.*
8.
 - 8.1. *There shall be an emergency treatment area in connection with infirmaries/treatment rooms. This shall comprise a floor area of a minimum of 2 x 3 metres with drainage and an anti-skid floor covering corresponding to the requirements for bathrooms. The area may be arranged in a corridor area or similar with minor traffic in the immediate vicinity of the treatment room.*
 - 8.2. *Access to the emergency treatment area shall satisfy the requirements in paragraph 3.2.*
 - 8.3. *The area shall be well lit as a work station with the facility to switch the light on/off locally.*
 - 8.4. *The following shall be within reach of the person providing treatment who is kneeling next to a patient situated roughly in the middle of the floor:*
 - 8.4.1. *Hand showers with individual cubicle and holder. The water supply (fresh hot and cold water) shall be thermostatically controlled.*
 - 8.4.2. *Telephone connected to the ship's internal telephone system with hands-free operation and, where appropriate, a head set, allowing the medical practitioner to be put through to the ship's communications system enabling direct communication with Radio Medical.*
 - 8.4.3. *A thin, water-repellent rubber mattress.*
 - 8.5. *For existing ships built before 1 August 2007, a bath tub may be equivalent to the stated emergency treatment area.*
9. *Infirmaries/treatment rooms shall be marked as such and may not be used for other purposes.*
10. *As to the ship's supply of medicaments, the existing provisions shall apply.*
11. *Hoist stretcher.*

Ships with a gross tonnage of 150 tonnes and upwards shall carry a hoist stretcher of a suitable type¹¹⁾ located in a suitable place.

Regulation 22 – Offices

- 1. In ships with a gross tonnage above 3000, one or more separate rooms shall be arranged as offices for the crew in the deck and engine section.*
- 2. Such rooms shall have a floor area of at least 6 m², and shall, as far as possible, be supplied with daylight and shall be equipped with the necessary furniture and fittings for office use.*

Regulation 23 – Cleaning and inspection

- 1. The accommodation shall be kept clean and tidy. It shall be cleaned daily. The rooms may be used only for goods or supplies belonging to the person(s) for whom the room is intended.*
- 2. The accommodation shall be disinfected as necessary after any infectious illness on board.*
- 3. Accommodation where vermin are found shall be cleaned and disinfected immediately.*
- 4. The master, or the person to whom he has delegated this task, shall, together with one or more crew members, inspect all parts of the accommodation at least once a week. The result hereof shall be entered in the log-book, where one is kept, or otherwise in the survey book.*

Regulation 24 – Exits¹²⁾

- 1. On each deck, there shall be at least two means of exit from each larger space or group of spaces, as widely separated from each other as possible.*
- 2. Furthermore, exits shall be located so that a fire at one deck level cannot cause persons to be trapped at another deck level.*
- 3. One of the exits may be an emergency exit through a hatchway/door or a sidescuttle/window, for which the following requirements are laid down:*
 - 3.1. A hatchway/door to open deck shall have a minimum clear opening of 0.60 x 0.60 m.*
 - 3.2. It shall be possible to open the hatchway/door directly from the inside, without using keys or tools. It shall also be possible to open the hatchway/door directly from the outside, although it is permissible for handles or other fittings to be removable and kept in a central place, e.g. the bridge. The hatchway/door may not be provided with padlock fittings.*
 - 3.3. A sidescuttle or window that is used as an emergency exit shall have a minimum clear opening of 0.45 m for sidescuttles and a minimum inside width across of 0.45 m for windows.*
 - 3.4. If the route from the accommodation space to the emergency exit is via separate spaces (steering gear room, other cabins, etc.), doors to such spaces may not be capable of being locked, unless they are fitted with kick hatches which can be removed in the direction of escape.*
 - 3.5. Any ladders, steps and handholds/handles necessary to facilitate passage through the emergency exits shall be fitted.*

¹¹⁾ Cf. the requirements for hoist stretchers in the Annex to Notices A from the Danish Maritime Authority, Chapter IX, Part B, Medical treatment and medicine on board ships.

¹²⁾ Reference is also made to chapter II-2, regulation 13.

- 3.6. Appropriate places, e.g. doors, “kick out escape panels”, at windows/sidescuttles, etc., shall be marked: “EMERGENCY EXIT”.

Part III – Passenger accommodation

Regulation 25 – Passenger accommodation, etc.

The definitions and provisions stipulated in part II, regulation 5, except for paragraphs 1.2 and 2.2, as well as regulation 6, regulation 7, regulation 9, regulation 10, paragraph 2, regulation 17, regulation 18¹³⁾ and regulation 24 shall also be applied, irrespective of the gross tonnage of the ship, unless mentioned otherwise below.

Regulation 26 – Location

1. The accommodation may not be located in superstructures that are not of a permanent character, neither fore of the collision bulkhead nor on the deck beneath the one that lies immediately below the waterline at the maximum permissible draught. In new ro-ro passenger ships, passenger cabins may not be placed below the ro-ro deck (the bulkhead deck). Furthermore, reference is made to the requirements on escape routes in chapter II-2, regulation 13.7.
2. Passengers may not be accommodated in rooms not approved for this purpose.
3. Sleeping rooms shall be separated from adjoining rooms in a suitable way, and they shall be provided with a clear marking of the maximum number of persons that they are intended for.

Regulation 27 – Determination of the number of passengers in individual rooms

1. For passenger ships on voyages lasting for more than one night:
 - 1.1. A berth or an approved permanent couchette shall be provided for all passengers.
 - 1.2. The number of persons in sleeping rooms shall be determined by dividing the free floor area of the sleeping rooms by 1.1 m². If sleeping rooms are fitted out with separate bathrooms or a bathroom with a toilet, the free floor area of these rooms may be included when calculating the number of persons. Irregular floor areas where the length and width are below 0.6 m are not included in the calculation. A shower cabinet with the said minimum dimensions may be included in the free area.
 - 1.3. On open deck to which the passengers have access, there shall be at least 0.5 m² free deck area for each passenger, in addition to the area mentioned in paragraph 1.2. Those parts of the deck where passengers cannot comfortably stand or sit are not included in this calculation.
2. For passenger ships on voyages that do not last for more than one night:
 - 2.1. Ships on night voyages, i.e. between 10 pm and 6 am, of more than six hours' duration shall have enclosed spaces for all passengers.
 - 2.2. The number of passengers in rooms other than the sleeping rooms shall be fixed as the lowest of the following figures:
 - 2.2.1. The floor area – measured in m² – available to the passengers, i.e. excluding serving counters and access to them as well as exits and the like, divided by 0.85 m².

¹³⁾ Reference is also made to chapter II-2, regulation 13.

- 2.2.2. *The floor area mentioned in paragraph 2.2.1 multiplied by the average height – measured in m – of the room measured from the top of the deck covering to the lower side of the deck beams or their panelling divided by 1.9 m³.*
- 2.2.3. *The number of seats in the room.*
- 2.3. *The number of persons in sleeping rooms shall be determined by dividing the free floor area of the sleeping rooms by 0.85 m². If sleeping rooms are fitted out with separate bathrooms or a bathroom with a toilet, the said free floor area may be included when calculating the number of persons. Irregular floor areas where the length and width are below 0.6 m are not included in the calculation.*
- 2.4. *The Danish Maritime Authority may permit deviations from the provisions of paragraphs 2.2 and 2.3 in the period from 1 May to 30 September.*
3. *For passenger ships engaged on daytime voyages:*
- 3.1. *For ships engaged on daytime voyages, i.e. voyages not lasting for more than six hours within the period from 10 pm to 6 am, 0.85 m² free floor area shall be calculated for each passenger in enclosed rooms that are not sleeping rooms; the room may not, however, be calculated for more passengers than there are seats for.*
- 3.2. *The provisions of paragraph 2.3 shall apply to any sleeping rooms.*
- 3.3. *During the period from 1 May until 30 September, in addition to the number of passengers permitted in enclosed spaces, it may be permitted to carry passengers on open deck, whereby at least 0.55m² floor area shall be calculated for each passenger. When calculating the passenger number, the space needed for the navigation etc. of the ship shall be excluded, including space for the handling and embarkation of life-saving appliances, together with all the areas of the deck in which passengers cannot comfortably sit or stand.*
- 3.4. *In ships or vessels with decks where, during the period from 1 May until 30 September, it is permitted to carry passengers on open deck, as stated above, there shall be enclosed spaces for at least 1/6 of the maximum permissible number of passengers.*

Regulation 28 – Toilets

1. *One toilet and one washbasin shall be provided for every 50 passengers or part thereof.*
2. *Such toilets shall be properly protected against the sea and the weather and be provided with the necessary flushing facilities.*
3. *All toilet facilities shall be well lit and ventilated.*
4. *The provisions of paragraphs 1 to 3 shall not apply to open vessels.*

Regulation 29 – Hospital

1. *In ships engaged in trade outside European waters and on which, taken together, the number of crew members and the maximum permitted number of passengers exceed 100, a hospital shall be provided on board. The hospital shall be well lit and well ventilated, insulated from the rooms that are intended for the crew and the passengers and shall be located at a place in the ship suitable and appropriate for this purpose where the inconvenience caused by noise and vibrations is as little as possible.*

2. *The hospital shall have four beds and, in addition, if the number of persons on board exceeds 120, one bed for every further 60 persons or part thereof.*
3. *The total floor area less the space taken up for beds shall be at least 1.1 m² for each person that the room is intended for; nonetheless there shall be reasonable space for stretcher transport and access to the beds.*
4. *The beds shall be made of a material with a hard, smooth surface that does not corrode, their internal dimensions shall be at least 1.98 m x 0.8 m, and they shall be arranged in such a way that they are easily accessible. The beds may not be placed on top of each other.*
5. *Next to each bed, there shall be a pushbutton with a wire connection ringing a bell located at a suitable place (that is normally manned).*
6. *The hospital shall include the following:*
 - 6.1. *A dedicated lockable space for the storage of medicine (dispensary).*
 - 6.2. *An operating room (possibly the dispensary) or another room the size of which is sufficient to set up an operating table that is accessible from all sides.*
 - 6.3. *A bathroom with a shower and emergency treatment area that complies with the provisions of regulation 21, paragraphs 5 and 8.*
 - 6.4. *A toilet with a washbasin for each of the hospital wards.*
 - 6.5. *The ventilation facility shall comply with the requirements of regulation 6.*
 - 6.6. *In ships engaged on voyages of quite short duration and where it may be anticipated that medical assistance will be available, the Danish Maritime Authority may permit deviations from the above provisions.*

Regulation 30 – Persons with reduced mobility

1. *Where it is practically possible, appropriate measures based on the following guidelines shall be implemented to ensure the safe access for persons with reduced mobility to all passenger ships and to all high-speed craft used for public transport and on which the keel is laid, or which are at a similar stage of construction, on 1 October 2004 or later.*
 - 1.1. *The IMO circular MSC/735 of 24 June 1996 entitled Recommendation on the design and operation of passenger ships to respond to elderly and disabled persons' needs shall be followed.*
 - 1.2. *Ships should be constructed and equipped in such a way that a person with reduced mobility can embark and disembark easily and safely, and can be ensured access between decks, either unassisted or by means of ramps, elevators or lifting platforms. Signed directions to such access facilities shall be posted at the other access points to the ship and at other appropriate locations throughout the ship.*
 - 1.3. *Signs provided for the orientation of passengers on board the ship shall be accessible and easy to read for persons with reduced mobility (including persons with sensory disabilities) and be positioned at key points.*
 - 1.4. *The operator shall have the means on board the vessel visually and verbally to provide announcements, such as those regarding delays, schedule changes and on board services, to persons with various forms of reduced mobility.*

- 1.5. *The alarm system and alarm buttons shall be designed so as to be accessible by and be able to alert all passengers with reduced mobility, including persons with sensory disabilities and persons with learning disabilities.*
- 1.6. *Handrails, corridors and passageways, doorways and doors shall accommodate the movement of a person in a wheelchair. Elevators, vehicle decks, passenger lounges, facilities and washrooms shall be designed in order to be accessible in a reasonable and proportionate manner to persons with reduced mobility.*
2. *The Danish Maritime Authority co-operates and consults with organisations representing persons with reduced mobility with regard to the implementation of the guidelines in regulation 30.1.*
3. *When passenger ships and high-speed craft used for public transportation and of which the keel is laid, or which are at a similar stage of construction, before 1 October 2004, are renovated, the guidelines in regulation 30.1 shall apply insofar as is economically reasonable and practicable.*

Notice from the Danish Maritime Authority B –

The Construction and Equipment, etc. of Ships

Chapter B II-4 A

Work space and workstations arrangement and equipment

<i>Introduction.....</i>	<i>1</i>
<i>Regulation 1 – Application</i>	<i>1</i>
<i>Regulation 2 – Definitions</i>	<i>1</i>
<i>Regulation 3 – General provisions on work spaces and arrangement of workstations</i>	<i>2</i>
<i>Regulation 4 – Mechanical Extraction from Working Spaces.....</i>	<i>3</i>
<i>Regulation 5 – Work space for storage and handling of paint, etc.</i>	<i>3</i>
<i>Regulation 6 – Galley equipment.....</i>	<i>4</i>
<i>Regulation 7 – Prevention of falls.....</i>	<i>4</i>
<i>Remarks to Regulations 6 and 7</i>	<i>5</i>

Introduction

This chapter contains constructive provisions for selected work areas as a consequence of the provisions contained in "Notices from the Danish Maritime Authority A, Regulations relating to Health and Safety on board Ships". If the provisions in this chapter are complied with, the requirements of the Danish Maritime Authority concerning good working conditions from the point of view of health and safety will normally be fulfilled in the said areas

On the basis of a concrete assessment, the Danish Maritime Authority may, however, lay down further requirements should it be determined that the mariner is exposed to unnecessary risk to health and safety.

Regulation 1 – Application

- 1. The provisions of this chapter apply to new ships.*

Regulation 2 – Definitions

- 1. "Work space": Any room on board the ship where work is carried out, e.g. wheelhouses, engine rooms, galleys, rooms from where machinery is supervised and operated, workshops, working rooms where substances and materials are handled, offices, etc.*
- 2. "Permanent workstation": The area in a work space or in another place where work is regularly carried out, i.e. at work benches, machine tools, cleaning vessels, pressure testing stands, cooking areas, or areas where paint is mixed and the tools used in relation hereto are cleaned, etc., and similar areas.*
- 3. "Separate mechanical extraction": Mechanical extraction system not connected to other ventilation systems.*
- 4. "Local mechanical extraction": Extraction that removes airborne particles, fumes and gases, aerosols, etc. as close to the source of pollution as possible.*

5. *"Galley equipment": Fittings, technical aids, including electrical machinery and apparatuses of any kind used in the preparation of foodstuffs, e.g. mixers, slicing machines, vegetable slicers, shredders, bread slicers, waste grinders, tilting roasting pans, and tilting saucepans.*
6. *"Unnecessary effect": An effect that can be significantly reduced and against which it seems reasonable to take preventive measures.*
7. *"New ship": A ship whose keel has been laid or which is at a similar stage of construction on 1 January 2001 or later.*
8. *"Open deck": A deck that is completely open above and on at least two sides.*

Regulation 3 – General provisions on work spaces and arrangement of workstations

1. *Work spaces and workstations on board the ship shall be arranged in such a way that as much consideration as possible is given to the conditions related to health and safety both from a separate and an overall assessment of the conditions of the working environment, including the motion of the ship in the sea, which may have an effect on the physical or mental health in the short or long term.*
2. *Where consideration of health and safety renders it necessary, the workstation shall be arranged in such a way that the work can be carried out in proper work spaces, unless the work is of a kind that is carried out on open deck or unless the requirement would be obviously unreasonable or inappropriate.*
3. *Work spaces and workstations shall be properly and appropriately arranged and located in consideration of the work processes that shall be carried out. This shall include ensuring that unnecessary effects from substances and materials, radiation, high temperatures, bad smells, noise, vibrations, etc. from the surroundings are avoided or, alternatively, reduced as much as possible.*
4. *The individual workstation shall be spacious enough for the necessary equipment, facilities, and materials to be put in mutually appropriate places so that all the functions of the work can be carried out safely and with the correct working postures and movements.*
5. *If the work can be carried out seated without inconvenience and without reducing the level of safety, the workstation shall be arranged accordingly. In the case of standing work or work that involves movement, there shall, if possible, be seats that can be used during work breaks.*
6. *The lighting at the workspace and at the workstation shall be sufficient for the work and the through-traffic to be carried out in a completely safe manner.¹*
7. *If practicable and if it does not reduce safety on board the ship, including fire safety, the work space shall have access to daylight through windows or similar.*
8. *Work spaces and workstations shall be designed and arranged in consideration of the conditions relating to cleaning, orderliness, and maintenance.*
9. *Where it is practicable, the temperature at the work spaces and at workstations where work is carried out regularly shall be adjusted to the human organism during the course of the work taking into consideration the methods used and the physical strain.*
10. *Hatches where the force required to open the hatch covers is 160 N or more shall be provided with a device helping to open the hatch. It shall be possible to secure all hatches in the open position.*

¹ Reference is made to Danish Standard 700 on artificial lighting in working rooms and guidelines in MSC/circ. 834 – Guidelines for Engineroom Layout, Design and Arrangement.

Regulation 4 – Mechanical Extraction from Working Spaces

1. If, during a process at a permanent workstation, dust, fumes, gases, aerosols or similar are produced superfluously or they are harmful to health, explosive, or disturbing, a permanent local mechanical extraction shall be installed.²
2. A local extraction system shall, therefore, be installed at welding benches, pressure testing stands, cleaning vessels for the washing of machinery parts, frying areas in galleys, fairly large dishwaters, and similar permanent workstations where substances and materials are handled and equipment used in this connection are cleaned, etc.
 - 2.1. The local extraction system shall have a suitable capture velocity (at a distance from the person working) dependent on the type of pollution, e.g.:
 - 2.1.1. Welding 0.5-1.0m/s
 - 2.1.2. Cleaning vessels (heated and unheated) 0.2-0.5 m/s
 - 2.1.3. Mixing/cleaning area in paint workshop 0.2-0.5 m/s
3. At workstations that cannot be regarded as permanent and where the same effects may occur as stated in paragraph 1 of this regulation, portable extraction equipment and/or appropriate personal protection equipment shall be used.
4. At any workspaces shall be supplied with sufficient fresh supplemental air of a suitable temperature and without any annoying draft. The amount of supplemental air shall be sufficient and the dimensioning of the inlet and outlet shall be well balanced.
5. The air outlet shall go to the open deck and it shall not be possible to return the air to the work space or other rooms in the ship via the ventilation systems (re-circulation). As regards machinery spaces and the like, the air extracted shall be led to either open deck or to the outlet flow from the room as close to the outlet to open deck as practicable and so that it is ensured that the air extracted is let out.
6. All extraction systems at permanent workstations shall be fitted with an operation indicator to show inadequate functioning.

Regulation 5 – Work space for storage and handling of paint, etc.

1. If painting work is to be carried out on board the ship during its operation, a workspace shall be established for the handling of paint, organic solvents, and flammable liquids. The workspace shall have access to the open deck or a ro-ro deck with ventilation that complies with the relevant regulations and be appropriately arranged, which includes a free floor area of at least 4 m². The work space and the room for storage of paint, organic solvents, flammable liquids, etc. may be combined.
2. Work space for the handling of paint shall be equipped with a local mechanical extraction at the workstation. The air in the work space shall be exchanged at least six times per hour.
 - 2.1. It shall be possible to stop the ventilation from outside the work space in connection with the release station for the required permanent fire-extinguishing system.
 - 2.2. As regards the capture velocity for the local extraction system, reference is made to regulation 4, paragraph 3.
3. Storage rooms that are only used to store paint, organic solvents, flammable liquids, etc. shall be equipped with a room extraction system which shall exchange the air at least six times per hour.

² Reference is made to Sector Specific Guidance no. 2, Point Extraction – paintshop, engine room, workshop, The Danish Maritime Occupational Health Service.

4. When mechanical extraction systems³⁾ are installed in rooms for storage and handling of paint, the provisions given in Notices from the Danish Maritime Authority B, Chapter 11-1, Part D, Regulation 45.10, and Chapter 11-2, Part C, Regulations 9.7 and 10.6.3, shall also be observed.

Regulation 6 – Galley equipment

1. Galley equipment shall be constructed and designed to comply with the current requirements for equipment sold in Denmark, which, *inter alia*, means
 - 1.1. that the equipment is constructed or shielded in such a way that persons cannot come into contact with moveable parts and other hazardous places during operation,
 - 1.2. that the shielding and other protective measures cannot simply be removed or put out of operation, and
 - 1.3. that removed or missing shielding or protective devices prevent the operation of the equipment and stop the equipment if removed during operation and that the equipment can be restarted only by reactivating the start switch.
2. Galley equipment that is CE-marked is normally regarded as complying with the provisions given in paragraph 1 of this regulation.
3. It must be possible to hold tilting roasting pans and tilting saucepans in all positions during the tilting motion. Tilting roasting pans and tilting saucepans which are cardanically suspended shall have a fixing device with a suitable number of settings. Control panels shall be placed appropriately.
4. Instructions shall be available containing adequate information about the use, maintenance, and cleaning of the galley equipment, and any hazards associated with the use of the equipment, if any, as well as instructions on how to avoid the hazards.

Regulation 7 – Prevention of falls

1. In areas where it can be foreseen that there is a risk of falling more than 2 m to the level below in connection with work carried out, this risk shall be met effectively. This can be done by setting up rails, fences, coverings and similar measures with the same level of safety. Where this is not possible, arrangements for fitting fall protection equipment shall be established.
2. Around hatches, companionways or similar openings in decks the coaming height of which is less than 0.75 metres measured from the top edge of the deck and which lead to spaces with a depth of more than 1.5 metres, it shall be possible to set up fencing of a height of at least 0.90 metres consisting of rails, handropes, chains or the like. In connection with these hatches, openings, secure ladders and/or steps on the hatch coaming shall be provided. The necessary space shall be provided around hatch coamings.⁴⁾
3. In engine rooms, cargo tanks, cargo holds, pump rooms, storerooms and similar places, staircases and ladders between level differences of 2 m or more shall be designed in such a way that it is possible to pass from one level to the next completely safely. Thus, staircases and ladders shall have a suitable inclination, which shall be less than 70 degrees in relation to the horizontal plane, and which shall have railings⁵⁾ along their entire length. In exceptional circumstances, where this is not possible, regulation 7.4 shall be observed.
4. Staircases or ladders with an inclination in relation to the horizontal plane of 70 degrees or more and with a height of more than 5 m above the deck or similar surface shall be provided with fittings to prevent falls when people pass between the levels. Such fittings shall, in the first

³⁾ Reference is made to the standard issued by the International Electrical Commission, IEC, 60092.

⁴⁾ Reference is made to ILO Convention no. 152.

⁵⁾ As to detailed design of staircases and ladders, reference is made to the Danish Maritime Authority's Guidance no. 2 of 6 June 1994 on safe access to and work in large tanks and large cargo spaces.

instance, be either ladder hoops or arrangements for fall prevention equipment in the form of rails or wires⁶⁾.

- 4.1. Ladder hoops shall be fitted from a height of 2.20 m above the surface. The ladder hoops shall continue at least 1 m above the level that the ladder leads to and shall at least comply with DVS 50027 or similar standards. Rest platforms shall be established at every 5 m. At the platforms, the sections of the ladder shall be displaced by at least 90 degrees in relation to each other.
 - 4.2. The arrangements in the form of wires or rails shall be mounted uninterruptedly along the entire length of the access route and at least 1 m above the level that the ladder leads to. Rest platforms shall be established at appropriate places so that the overall distance of the staircase/ladder section does not exceed 15 m.
 - 4.3. The rest platforms shall be of an appropriate size, but at least 600 x 600 mm, and be provided with anti-slip covering and a guardrail with knee and toe rails at least 1 m in height.
5. Where it is not possible to mount ladder hoops or arrangements for fall protection equipment, measures with the same level of safety shall be taken to prevent falls when people pass between levels.

Remarks to Regulations 6 and 7

Equipment that is CE marked is normally regarded as complying with the requirements that apply to the relevant equipment within the EU.

With regard to galley equipment, this means compliance with the requirements of Directive 89/392/EEC on the approximation of the laws of the member states relating to machinery (Machinery Directive) with later amendments, which is implemented in Denmark by way of the National Working Environment Authority's Order no. 561 of 24 June 1994 on the arrangement of technical aids.

With regard to fall protection equipment, this means compliance with the requirements of Directive 89/686/EEC on the approximation of the laws of the member states relating to personal protective equipment, with later amendments, which is implemented in Denmark by way of the National Working Environment Authority's Order no. 1273 of 18 December 1996 on safety requirements etc. for personal protective equipment. Personal life-saving appliances as required in accordance with the SOLAS Convention are not covered by these provisions.

⁶⁾ Reference is made to Sector Specific Guidance, Fall Arrest Systems, The Danish Maritime Occupational Health Service, 2000.

***Notice from the Danish Maritime Authority B –
The Construction and Equipment, etc. of Ships***

Chapter B II-4 B

Working Spaces – Arrangement and Equipment

<i>Regulation 1 – General Provisions</i>	1
<i>Regulation 2 – Containers</i>	1
<i>Regulation 3 – Arrangement of Containers</i>	2
<i>Regulation 4 – Pipe Installations</i>	2
<i>Regulation 5 – Control prior to Installation</i>	4
<i>Regulation 6 – Control of Flushing and Leakage Tests after Installation</i>	4
<i>Regulation 7 – Authorization</i>	4
<i>Regulation 8 – Portable Equipment for welding with acetylene and oxygen</i>	4

Part B – Central Systems for Welding with Acetylene and Oxygen

Regulation 1 – General Provisions

1. Acetylene (C^2H^2) shall be stored in special containers (1.5-1.8 N/mm² at 15°C).
2. Oxygen (O^2) shall be stored in gaseous condition in special containers (15-20 N/mm² at 15°C).
3. The central system shall be arranged in a separate container space or in a separate container cabinet, cf. regulation 3, with a permanent arrangement for each gas – including high-pressure manifolds with a closable high-pressure non-return valve for each connected container, any high-pressure hoses, a main regulator including pressure gauges for high- and low-pressure, safety valves, fixing arrangements for containers and operating instructions.
4. A welding station shall consist of an arrangement comprising stop valves with connections to the low-pressure piping, a backflash valve for acetylene ending in a 3/8" left-hand thread, oxygen reduction valve with a pressure gauge, a backflash valve for oxygen ending in a 3/8" right-hand thread as well as a hose connection fitted with a coupling for each gas.
5. The burners, stop valves, main regulators and valves, backflash valves and hoses shall be of a recognized and accepted type. Burners shall be of the straight tube type.
6. Operating and maintenance instructions for the equipment shall be available.

Regulation 2 – Containers

1. The containers shall be approved by a recognized authority/institution or by a recognized classification society.
2. Only containers of 50 litres or less may be used.
3. The containers shall be stamped with the tare and gross weight, the month and year of the latest pressure test and the test pressure.

4. *The containers, including spare containers, shall be stored in an upright position and shall be secured properly. The securing arrangement shall be designed so that rapid dismounting of the containers may be carried out.*

Regulation 3 – Arrangement of Containers

1. *Regardless of their number, the containers shall be placed above the bulkhead deck outside engine rooms and areas presenting an explosion hazard, i.e. outside areas where other readily ignitable and/or explosive gases or fumes may be expected to be present.*
2. *A container space shall be a separate room enclosed by gas-tight steel bulkheads, steel decks, etc. against the inside of the ship. Access to the room shall be possible only from the open deck, and the door to the room shall open outwards.*
 - 2.1. *The room shall be insulated, ventilated and arranged so that the room temperature will not normally exceed 40°C. If temperature conditions permit, natural ventilation may be used.*
3. *A container cabinet shall be made in steel and it shall be solidly installed on the free deck. The cabinet doors shall open outwards.*
 - 3.1. *The cabinet shall be ventilated and arranged so that the cabinet temperature will not normally exceed 40°C.*
4. *Electric installations and components – including switches, light fittings, ventilation motors, etc. – in rooms/cabinets shall be of an explosion-proof design.*
5. *A sign with the following text shall be placed on the outside of doors to rooms and cabinets:*

<p style="text-align: center;">PRESSURE BOTTLES TO BE REMOVED IN CASE OF FIRE NAKED FLAME PROHIBITED</p>

6. *It shall be possible to get access to the room/cabinet rapidly and easily regardless of whether the doors are locked, and fixed tools for the closing of stop valves as well as for the dismounting of containers and fittings shall be available.*
7. *In the room/cabinet, durably designed instructions for the handling of acetylene and oxygen as well as for the operation of the system shall be available. The contents of such instructions shall be written in a simple and clear manner to avoid wrong operation.*
 - 7.1. *The instructions shall, among other things, underline that oil products and fatty substances may under no circumstances be introduced into the room/cabinet, that the room/cabinet may not be entered by persons whose skin (hands) or clothing are significantly contaminated with oil or a fatty substance, and that portable electric equipment may not be brought into the room or introduced into the container cabinet.*

Regulation 4 – Pipe Installations

1. The High-Pressure Side for Acetylene

- 1.1. *Manifolds shall be made of seamless steel tubing. Pipes and fittings shall be dimensioned for 30 N/mm² and shall be hydraulically pressure-tested with the said pressure before being fitted. Copper or copper alloys with a copper content of 65 per cent by weight or more may not be used.*

- 1.2. *If more than one container is connected to the manifold, a stop valve shall be fitted for each container directly on the manifold.*
2. **The High-Pressure Side for Oxygen**
 - 2.1. *Manifolds shall be made of either seamless copper tubing or seamless steel tubing dimensioned and pressure-tested as stipulated in Regulation 4, Paragraph 1.1.*
 - 2.2. *Stop valves shall be fitted as stipulated in paragraph 1.2.*
3. **The Low-Pressure Side for Acetylene and Oxygen**
 - 3.1. *Low-pressure pipes for acetylene shall be made of seamless steel tubing. The internal diameter shall not exceed 30 mm.*
 - 3.2. *Low-pressure pipes for oxygen shall be made of either seamless copper tubing or seamless steel tubing.*
 - 3.3. *The low-pressure side for acetylene shall be connected to the high-pressure side via a reduction valve reducing the acetylene pressure to a maximum of 0.09 N/mm². Immediately after the reduction valve, a safety valve that opens between 0.15 N/mm² and 0.17 N/mm² shall be installed. The discharge pipe from the safety valve shall lead to the open air.*
 - 3.4. *The low-pressure side for oxygen shall be connected to the high-pressure side via a reduction valve reducing the oxygen pressure to a maximum of 1.5 N/mm². Immediately after the reduction valve, a safety valve shall be installed preventing the pressure from exceeding 2.25 N/mm². The discharge pipe from the safety valve shall lead to the open air.*
 - 3.5. *The low-pressure piping shall be installed outside the crew and passenger accommodation and shall be accessible for inspection. Furthermore, the pipelines shall be installed outside non-ventilated spaces and cabinets.*
 - 3.6. *The pipelines shall be permanently installed with the necessary scope for expansion and in a way so that they may not easily be exposed to mechanical overload.*
 - 3.7. *The number of pipe joints shall be as few as possible. Joints shall primarily be produced by welding or brazing. Silver brazing may not be used in connection with fittings and pipelines for acetylene.*
 - 3.8. *Where the pipelines penetrate non-watertight bulkheads and decks, they shall be protected by protective tubing made of hard plastic fibre or the like. Where the pipelines penetrate watertight bulkheads and decks, a watertight stuffing box shall be fitted.*
 - 3.9. *The stuffing material shall be suitable for acetylene (aluminium or fibre) and oxygen (copper, aluminium or fibre), respectively.*
 - 3.10. *The seamless steel tubing mentioned in this regulation shall be tested according to DS/EN 10246.*
4. **Welding Stations**
 - 4.1. *Normally, welding stations may be placed only in engine rooms and/or workshops.*
 - 4.2. *At every welding station, there shall be a solidly fitted sign stating, among other things, that the valves of the welding station and stop valves in the room/cabinet shall be closed when the welding equipment is not in use.*

Regulation 5 – Control prior to Installation

1. *In addition to the pressure tests mentioned in regulation 4, paragraphs 1 and 2, the following shall be carried out before the installation may be carried out on board the ship: The pipelines, joints and fittings, etc. for oxygen shall be carefully cleaned for fatty substances. Trichloroethylene or a similar cleaning agent may be used for the cleaning – petrol may not be used. When the cleaning has been carried out, the pipes, joints and fittings, etc. shall be finally cleaned with a 10 per cent trisodium phosphate solution to remove residues of cleaning fluids and then the pipes shall be flushed with nitrogen.*
2. *A written statement that the control mentioned in paragraph 1 has been carried out shall be present on board and be shown on request.*

Regulation 6 – Control of Flushing and Leakage Tests after Installation

1. *Nitrogen shall be used for the flushing of pipelines for acetylene, while either nitrogen or fat-free, purified compressed air shall be used for the flushing of pipelines for oxygen. The container containing the medium to be used for the flushing shall be connected to the low-pressure side. Regulators, backflash valves, pressure gauges, etc. shall be dismantled during the flushing, which shall last until the pipes are clean.*
 - 1.1. *When flushing pipelines for acetylene, the pressure shall gradually be increased to about 0.8 N/mm².*
 - 1.2. *When flushing pipelines for oxygen, the pressure shall gradually be increased to about 1.5 N/mm².*
2. *The leakage test of pipelines for acetylene shall be carried out with nitrogen. During the testing, the valves, joints, etc. shall be brushed with soapy water and be examined for any leaks.*
 - 2.1. *The high-pressure side shall be leakage-tested with 6 N/mm² and the low-pressure side with 0.8-1 N/mm²*
 - 2.2. *After 8 hours, the pressure drop on the low-pressure side may not exceed 0.04 N/mm².*
3. *The leakage test of pipelines for oxygen shall be carried out with either nitrogen or fat-free, purified air, and the pipelines shall be brushed with soapy water and examined.*
 - 3.1. *The high-pressure side shall be leakage-tested with 20 N/mm² and the low-pressure side with 2.25 N/mm².*
4. *A written statement that the control mentioned in regulation 6, paragraphs 1, 2 and 3 has been carried out shall be submitted to the Danish Maritime Authority or the classification society in connection with a survey of a new system, cf. Regulation 7.*

Regulation 7 – Authorization

1. *The relevant classification society or the chief engineer of the ship is authorized to carry out the tests and examinations required in regulations 5 and 6 and to issue the necessary written documentation.*

Regulation 8 – Portable Equipment for welding with acetylene and oxygen

1. *Burners shall be of the straight tube type and be fitted with a backflash valve for acetylene.*
2. *The provisions of regulation 1, paragraphs 1, 2 and 5 and of regulation 2, paragraph 3 shall be complied with.*

***Notice from the Danish Maritime Authority B –
The Construction and Equipment, etc. of Ships
Chapter B II-4 C***

Working Spaces – Arrangement and equipment

The provisions of this part are in accordance with those of the international standard IEC/TS 62081 (1999), "Arc welding equipment – installation and use".

<i>Regulation 1 – Application</i>	<i>1</i>
<i>Regulation 2 – Definitions</i>	<i>1</i>
<i>Regulation 3 – Installation.....</i>	<i>2</i>
<i>Regulation 4 – Use of welding equipment</i>	<i>3</i>

Part C – Installation and use of equipment for arc welding and allied processes

Regulation 1 – Application

1. *These provisions shall apply to the installation and use of welding power sources, equipment and accessories for arc welding and allied processes on board ships, the most common of which are:*

- Manual metal arc welding (MMA);*
- Tungsten inert gas arc welding (TIG);*
- Metal inert gas welding (MIG);*
- Metal active gas welding (MAG);*

but which also comprise:

- Powder welding;*
- Plasma welding;*
- Plasma cutting;*
- Arc cutting;*
- Flame-spraying;*
- Plasma-spraying;*
- and others.*

Regulation 2 – Definitions

1. *"Welding circuit" means a circuit that includes all conductive material, including the arc, through which the welding current is intended to flow.*

2. *"Extraneous conductive part" means a conductive part that does not form a part of the electrical installation and is liable to introduce a certain potential, generally the earth potential (under ordinary conditions, the ship is an extraneous conductive part).*
3. *"Work piece" means one or more metal pieces on which welding or allied processes are performed.*
4. *"Personal protective means" means protective clothing and accessories (e.g. gloves, hand shields, head masks, filter lenses) used to diminish electric shock risks, to protect against welding fumes and spatter, and to protect the eyes and the skin against radiation and heat.*
5. *"Environments with increased hazard of electric shock" means environments where the hazard of electric shock by welding is increased in relation to normal welding conditions, e.g. where freedom of movement is restricted, in locations fully or partially limited by conductive elements, and in wet, damp and hot locations.*
6. *"Expert" means a welder who can judge the work assigned to him or her and who can recognise possible hazards on the basis of professional training, cf. the requirement of regulation 4.6, knowledge, experience and knowledge of the relevant equipment.*

Regulation 3 – Installation

1. General

- 1.1. *Welding power sources, equipment, cables and accessories used in installations for electrical arc welding shall be CE-marked in accordance with Council Directive 73/23/EEC of 19 February 1973 on the harmonization of the laws of Member States relating to electrical equipment designed for use within certain voltage limits, "the Low Voltage Directive", as amended, cf. Order no. 797 of 30 August 1994 on the entry into force of the said Directives.*
- 1.2. *The electromagnetic compatibility (EMC) requirements shall be taken into consideration during installation.*
- 1.3. *Full use shall be made of all technical data relevant to the welding equipment, including the manufacturer's instructions.*
- 1.4. *Specific advice shall be obtained from the manufacturer of the welding equipment as necessary.*

2. Selection of supply cable and protection against overload

- 2.1. *Supply cables for welding power sources and their overload protection shall be selected on the basis of information given by the manufacturer of the welding equipment.*
- 2.2. *Supply cables shall be placed or armoured so that they cannot be damaged in use. In order to reduce the risk of electric shock in connection with any damaged cables, a sensitive residual current circuit breaker with a leakage current not exceeding 30 mA may be used.*

3. Supply disconnecting device

If the welding equipment is not fitted with a supply disconnecting device, the person installing the welding equipment shall ensure that such a disconnecting device is fitted at the point of supply.

4. Emergency stopping device

Emergency stopping devices shall comply with paragraph 1.1.

5. Protection against electric shock from the mains supply

The equipment shall be constructed according to paragraph 1.1.

6. Isolation from the mains supply

The welding circuit and circuits electrically connected to the welding circuit shall be electrically isolated from the mains supply. This shall be verified by the foreman.

7. Welding voltage supply

7.1. *In cases where more than one welding power source is in use at the same time, their no-load voltages can be cumulative and create an increased hazard of electric shock. Welding power sources shall be installed so as to minimise this risk. Guidance is given in the associated annex on voltages and connections.*

7.2. *Where more than one welding power source is installed, the individual welding power sources with their separate controls and connections shall be clearly marked to show which items belong to any one welding circuit.*

8. Location of gas cylinders

Measures shall be taken to prevent gas cylinders in the vicinity of the work piece becoming part of the welding circuit.

Regulation 4 – Use of welding equipment

1. General

1.1. *Arc welding equipment and accessories shall be CE-marked in accordance with the provisions of regulation 3.1.1. Before welding equipment is put into service, the user shall take account of the instructions provided by the manufacturer and any other relevant requirements.*

1.2. *Consideration shall be given to the environment in which the welding equipment is used as specific precautions may need to be taken.*

2. Connection between several welding power sources

2.1. *If more welding power sources are to be connected in parallel or in series, this shall be carried out by an expert in accordance with the manufacturer's recommendations and the foreman's verification. The equipment may not be used until a test has been carried out to ensure that the permissible no-load voltage cannot be exceeded. Reference is also made to the associated annex on voltages and connections.*

2.2. *When a welding power source connected in parallel or in series is taken out of service, this power source shall be disconnected from the mains supply and the welding circuit so as to preclude any hazards that might be caused by feed-back voltages.*

3. Inspection and maintenance of the welding installation

3.1. *On installation and periodically thereafter, the foreman shall check the following:*

3.1.1. *that the welding equipment has been correctly selected and connected for the work to be carried out in accordance with the manufacturer's instructions;*

3.1.2. *that all connections are clean and tight; and*

3.1.3. *that the welding equipment is in good condition.*

3.2. *Furthermore, all protective earthing shall be checked for effectiveness. Any defects found shall be repaired. Particular attention shall be paid to the installation of supply and welding cables, electrode holders and coupling devices. The operator shall be instructed to check all external connections each time a reconnection is made. Any defects found shall be reported, and faulty equipment may not be used. The welding current return clamp (the earth clamp) shall be connected directly to the work piece as close as*

practicable to the point of welding or to the welding bench on which the work piece is situated or to the work-handling device.

3.3. *For plasma cutting where the no-load voltages are higher than with welding, particular care shall be taken when carrying out inspection and maintenance procedures. Particular attention shall be paid to the water cooling equipment to ensure that any leaks do not affect the insulation.*

3.4. *Before carrying out arc welding on equipment having associated transformers, such transformers shall be disconnected to avoid the hazard of shock from induced voltages on the input side of the transformers.*

4. Disconnection of welding power sources and/or welding circuits

4.1. *When operators interrupt their work or leave their work place, the power source shall be switched off.*

4.2. *If the supply cable is liable to damage when the welding power source is moved to another location, the welding power source, including its supply cable, shall be disconnected from the mains supply before it is moved.*

4.3. *When maintenance or repair work is carried out on the welding equipment, the input and output should be disconnected.*

5. Guards

Guards and removable parts shall be in position before the welding equipment is made live.

6. Operator training and obligation to provide operators with instructions and information

Welders shall have attended and passed at least the module of the ship's assistant training containing requirements for welding skills, other equivalent training or have several years of practical experience with the welding technique in question. Any assistants to operators shall have received sufficient instructions of a professional and safety-related character about the welding process in question. Other persons working in the vicinity of the welding operation shall be warned of the hazards and informed about protective measures concerning arc processes.

Annex

Voltages and connections

1. Voltages between electrode holders or torches (more welding power sources)

- 1.1. When working with several welding power sources on a single work piece or on conductively connected work pieces, a hazardous sum of no-load voltages may arise between two electrode holders or torches. This voltage may reach twice the value of the admissible no-load voltage (see also regulation 3.7).
- 1.2. The foreman shall ensure that a measuring device is used to determine whether there is a hazard.
- 1.3. Operators shall:
 - 1.3.1. be warned of this hazard;
 - 1.3.2. never touch two electrode holders or torches at the same time;
 - 1.3.3. work out of reach of each other, where practicable.
- 1.4. The following examples show schematically the influence that the connection to the mains supply and the polarity for welding may have on the sum of welding voltages between electrode holders and torches. It is assumed that the no-load voltages for each welding power source are identical, but in practice they may differ (see items (5) to (7) below).
- 1.5. Direct current
 - 1.5.1. The connections to the mains supply have no influence on the sum of no-load voltages. The voltage "U" depends on the polarity of the output connections (see figure A).

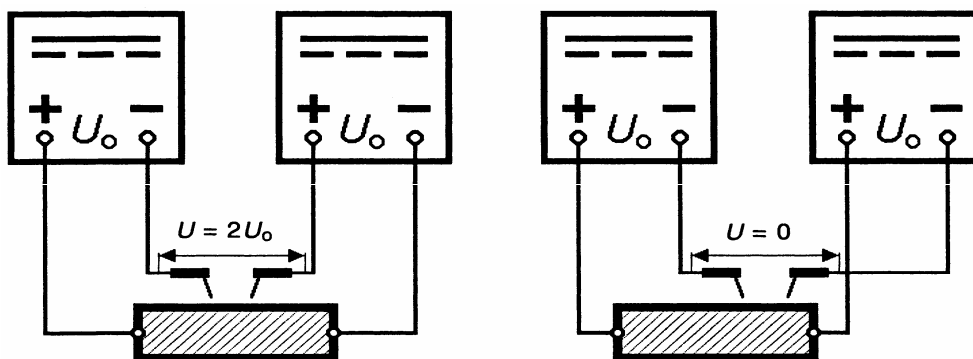

Figure A: Example of d.c. voltage between electrode holders or torches

- 1.6. Alternating current single-phase welding power sources
 - 1.6.1. The connections to the mains supply and the output connections will influence the sum "U" of the no-load voltages (see figure B).

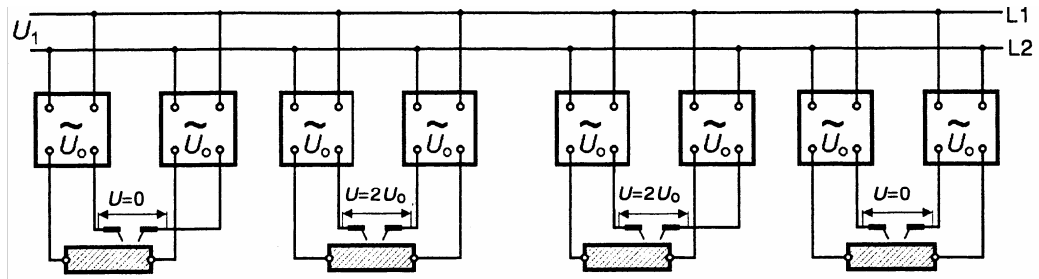

Figure B: Example of a.c. voltage between electrode holders or torches – Single-phased supply from the same pair of lines of a three-phase mains supply

1.6.2. If the connections to a three-phase mains supply are made across different pairs of lines, the sum "U" of the no-load voltages will always be greater than zero (see figure C).

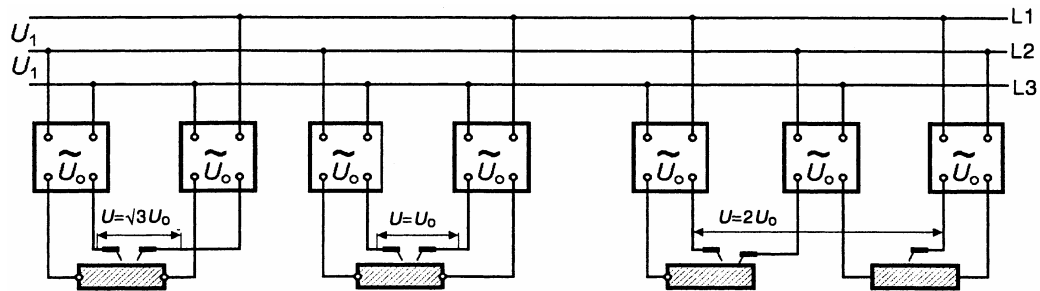

Figure C: Example of a.c. voltage between electrode holders or torches – Single-phase supply from different pairs of lines of a three-phase mains supply

1.6.3. Increased a.c. voltages can be avoided by reversing:

1.6.3.1. the welding cable connections; or

1.6.3.2. the mains supply connections to the welding power source (see regulation 4.2).

1.7. Three-phase multi-operator welding transformer

1.7.1. The connections to the mains supply have no influence on the sum "U" of the no-load voltages (see figure D).

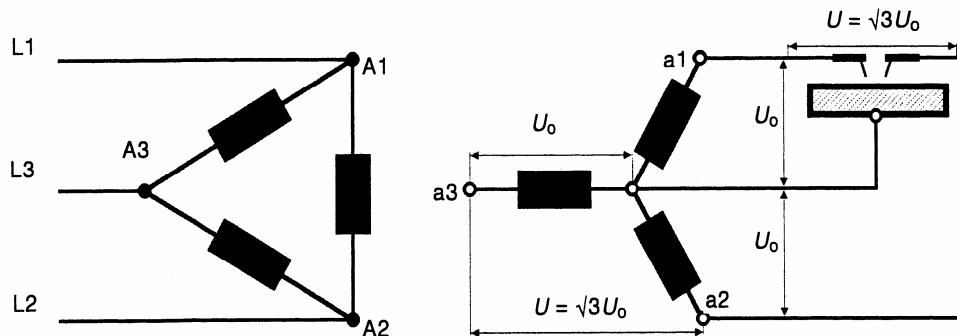

Figure D: Example of a.c. voltage between different electrode holders connected between different lines of output

2. Connection between the welding power source and the work piece

2.1. When the welding current does not flow entirely in the welding circuit, part of the welding current occurs as harmonics (stray currents). These may cause damage and shall be eliminated by the following means:

- 2.1.1. The electrical connection between the welding power source and the work piece shall be made as direct as practicable by means of an insulated welding return cable (earth connection) having an adequate current carrying capacity.
- 2.1.2. Extraneous conductive parts, such as metal rails, pipes and frames, may not be used as part of the welding return circuit, unless they constitute part of the work piece itself.
- 2.1.3. The welding current return clamp shall be located as near as practicable to the welding arc.
- 2.1.4. The welding circuit shall not be earthed (see paragraph 3 below).
- 2.1.5. Connection of the welding return cable to the work piece shall be ensured by the use of devices having suitable means for cable connection, a fastening system not liable to come loose accidentally, and good electrical contact. Magnetic devices only present a good electrical contact if the contact surfaces of the magnetic device and the contact area of the work piece are sufficiently large, even, conductive and clean (e.g. free from rust and primer) and if the contact area of the work piece is magnetic.
- 2.1.6. Connection devices for non-stationary, flexible welding cables in the welding circuit shall:
 - 2.1.6.1. have an adequate covering of insulating material to prevent inadvertent contact with voltage carrying parts when connected (with the exception of the welding return current clamp at the work piece itself);
 - 2.1.6.2. be suitable for the sizes of cables used and the welding current;
 - 2.1.6.3. be effectively connected to the welding cables and in good electrical contact with them.

- 2.2. *Both the welding cable and the connection device shall be used within their specified current rating. The connection device may not be fitted with a cable smaller in diameter than specified by the manufacturer of the connection device.*
- 2.3. *When coupling devices are used, they shall comply with regulation 3.1.1.*
3. ***Earthing of the work piece***
 - 3.1. *The welding circuit shall not be earthed since it may increase the risk of harmonics (stray welding currents) (see paragraph 2 above). Earthing of the welding circuit may also increase the area of metal through which a person in contact with the welding circuit, e.g. the welding electrode, could receive a shock.*
 - 3.2. *An assessment of the welding circuit and the welding area shall ensure that welding current will not flow through a connection intended for the protective earth connection of equipment frame conduit or any object connected to earth but not intended or capable to carry the welding current.*
 - 3.3. *If electrical tools are used which may come into contact with the work piece, such tools shall be of class II equipment , i.e. with double or reinforced insulation without protective earth connection.*
 - 3.4. *Precautions shall be taken to insulate the operator from earth as well as from the work piece.*
4. ***Welding in an environment with increased hazard of electric shock***
 - 4.1. *When welding is carried out in an environment with increased hazard of electric shock, operators shall only be permitted to weld when other persons who have been instructed and who are able to help in case of an emergency are in the immediate vicinity. Means for electrically disconnecting the welding power source or the welding circuit quickly shall be provided within easy access to these persons.*
 - 4.2. *The following precautions shall be taken to reduce the risk of an electric shock from the voltage between the welding electrode and earth.*
 - 4.2.1. *The welding power source shall be out of normal reach of the operator during welding. Additional protection against a shock from current from the mains supply under fault conditions may be provided by the use of a residual current circuit breaker that is capable of operating at a leakage current not exceeding 30 mA and feeds all mains powered equipment in the vicinity.*
 - 4.2.2. *Remote controls shall be supplied with the protective measure "safety extra low voltage" (SELV).*
 - 4.2.3. *Only welding power sources and welding equipment intended for use in environments with increased hazard of electric shock shall be used. Where appropriate, voltage reducing devices shall be used. This shall be verified by the foreman unless the welding power source is marked with the symbol S.*
 - 4.2.4. *Electrode holders shall conform to type A or B.*
 - 4.2.5. *Insulating platforms or mats shall be used wherever possible.*

**Notice from the Danish Maritime Authority B –
The Construction and Equipment, etc. of Ships**

Chapter B II-5 A

**REVISED ARTICLES OF INTERNATIONAL CONVENTION ON LOAD
LINES, 1966**

INTERNATIONAL CONVENTION ON LOAD LINES, 1966

Article 1.....	3
General Obligation under the Convention	3
Article 2.....	3
Definitions.....	3
Article 3.....	4
General Provisions	4
Article 4.....	4
Application.....	4
Article 5.....	4
Exceptions.....	4
Article 6.....	5
Exemptions.....	5
Article 7.....	5
Force Majeure	5
Article 8.....	5
Equivalentents.....	5
Article 9.....	6
Approvals for Experimental Purposes	6
Article 10.....	6
Repairs, Alterations and Modifications	6
Article 11.....	6
Zones and Areas.....	6
Article 12.....	6
Submersion.....	6
Article 13.....	7
Surveys and Marking	7
Article 14.....	7
Initial and Periodical Surveys and Inspections	7
Article 15.....	8
Maintenance of Conditions after Survey	8

Article 16.....	8
Issue of Certificates.....	8
Article 17.....	8
Issue or Endorsement of Certificates by Another Government	8
Article 18.....	8
Form of Certificates	8
Article 19.....	9
Duration and Validity of Certificates.....	9
Article 20.....	10
Acceptance of Certificates	10
Article 21.....	10
Control	10
Article 22.....	11
Privileges.....	11
Article 23.....	11
Casualties	11
Article 24.....	11
Prior Treaties and Conventions.....	11
Article 25.....	12
Special Rules drawn up by Agreement	12
Article 26.....	12
Communication of Information	12
Article 27.....	12
Signature, Acceptance and Accession	12
Article 28.....	12
Coming into force	12
Article 29.....	13
Amendments	13
Article 30.....	14
Denunciation	14
Article 31.....	15
Suspension	15
Article 32.....	15
Territories.....	15
Article 33.....	16
Registration	16
Article 34.....	16
Languages	16

The Contracting Governments,

DESIRING to establish uniform principles and rules with respect to the limits to which ships on international voyages may be loaded having regard to the need for safeguarding life and property at sea;

CONSIDERING that this end may best be achieved by conclusion of a Convention,

HAVE AGREED as follows:

Article 1

General Obligation under the Convention

- (1) The Contracting Governments undertake to give effect to the provisions of the present Convention and the Annexes hereto, which shall constitute an integral part of the present Convention. Every reference to the present Convention constitutes at the same time a reference to the Annexes.
- (2) The Contracting Governments shall undertake all measures which may be necessary to give effect to the present Convention.

Article 2

Definitions

For the purpose of the present Convention, unless expressly provided otherwise:

- (1) "Regulations" means the Regulations annexed to the present Convention.
- (2) "Administration" means the Government of the State whose flag the ship is flying.
- (3) "Approved" means approved by the Administration.
- (4) "International voyage" means a sea voyage from a country to which the present Convention applies to a port outside such country, or conversely. For this purpose, every territory for the international relations of which a Contracting Government is responsible or for which the United Nations are the administering authority is regarded as a separate country.
- (5) A "fishing vessel" is a ship used for catching fish, whales, seals, walrus or other living resources of the sea.
- (6) "New ship" means a ship the keel of which is laid, or which is at a similar stage of construction, on or after the date of coming into force of the present Convention for each Contracting Government.
- (7) "Existing ship" means a ship which is not a new ship.
- (8) "Length" means 96 % of the total length on a waterline at 85 % of the least moulded depth measured from the top of the keel, or the length from the fore-side of the stem to the axis of the rudder stock on that waterline, if that be greater. Where the stem contour is concave above the waterline at 85 % of the least moulded depth, both the forward terminal of the total length and the fore-side of the stem respectively shall be taken at the vertical projection to that waterline of the after most point of the stem contour (above that waterline). In ships designed with a rake of keel the waterline on which this length is measured shall be parallel to the designed waterline.
- (9) "Anniversary date" means the day and the month of each year which will correspond to the date of expire of the relevant certificate.

Article 3

General Provisions

- (1) No ship to which the present Convention applies shall proceed to sea on an international voyage after the date on which the present Convention comes into force unless it has been surveyed, marked and provided with an International Load Line Certificate or, where appropriate, an International Load Line Exemption Certificate in accordance with the provisions of the present Convention.
- (2) Nothing in this Convention shall prevent an Administration from assigning a greater freeboard than the minimum freeboard determined in accordance with Annex I.

Article 4

Application

- (1) The present Convention shall apply to :
 - (1)(a) ships registered in countries the Governments of which are Contracting Governments;
 - (1)(b) ships registered in territories to which the present Convention is extended under Article 32; and
 - (1)(c) unregistered ships flying the flag of a State, the Government of which is a Contracting Government.
- (2) The present Convention shall apply to ships engaged on international voyages.
- (3) The regulations contained in annex I, unless expressly provided otherwise, are applicable to new ships.
- (4) Existing ships which do not fully comply with the requirements of the Regulations contained in Annex I or any part thereof shall meet at least such lesser related requirements as the Administration applied to ships on international voyages prior to the coming into force of the present Convention; in no case shall such ships be required to increase their freeboards. In order to take advantage of any reduction in freeboard from that previously assigned, existing ships shall comply with all the requirements of the present Convention.
- (5) The Regulations contained in Annex II are applicable to new and existing ships to which the present Convention applies.

Article 5

Exceptions

- (1) The present Convention shall not apply to:
 - (1)(a) ships of war;
 - (1)(b) new ships of less than 24 metres (79 feet) in length;
 - (1)(c) (e) existing ships of less than 150 tons gross;
 - (1)(d) pleasure yachts not engaged in trade;
 - (1)(e) fishing vessels.
- (2) Nothing herein shall apply to ships solely navigating:
 - (2)(a) the Great Lakes of North America and the River St. Lawrence as far east ,as a rhumb line drawn from Cap des Rosiers to West Point, Anticosti Island, and, on the north side of Anticosti Island, the meridian of longitude 63°W;
 - (2)(b) the Caspian Sea;

- (2)(c) the Plate, Parana and Uruguay Rivers as far east as a rhumb line drawn between Punta Rasa (Cabo San Antonio), Argentina, and Punta del Este, Uruguay.

Article 6

Exemptions

- (1) Ships when engaged on international voyages between the near neighbouring ports of two or more States may be exempted by the Administration from the provisions of the present Convention, so long as they shall remain engaged on such voyages, if the Governments of the States in which such ports are situated shall be satisfied that the sheltered nature or conditions of such voyages between such ports make it unreasonable or impracticable to apply the provisions of the present Convention to ships engaged on such voyages.
- (2) The Administration may exempt any ship which embodies features of a novel kind from any of the provisions of this Convention the application of which might seriously impede research into the development of such features and their incorporation in ships engaged on international voyages. Any such ship shall, however, comply with safety requirements, which, in the opinion of that Administration, are adequate for the service for which it is intended and are such as to ensure the overall safety of the ship and which are acceptable to the Governments of the States to be visited by the ship.
- (3) The Administration which allows any exemption under paragraphs (1) and (2) of this Article shall communicate to the International Maritime Organization (hereinafter called the Organization) particulars of the same and reasons therefor which the Organization shall circulate to the Contracting Governments for their information.
- (4) A ship which is not normally engaged on international voyages but which, in exceptional circumstances, is required to undertake a single international voyage may be exempted by the Administration from any of the requirements of the present Convention, provided that it complies with safety requirements which, in the opinion of that Administration, are adequate for the voyage which is to be undertaken by the ship.

Article 7

Force Majeure

- (1) A ship which is not subject to the provisions of the present Convention at the time of its departure on any voyage shall not become subject to such provisions on account of any deviation from its intended voyage due to stress of weather or any other cause of force majeure.
- (2) In applying the provisions of the present Convention, the Contracting Governments shall give due consideration to any deviation or delay caused to any ship owing to stress of weather or any other cause of force majeure.

Article 8

Equivalents

- (1) The Administration may allow any fitting, material, appliance or apparatus to be fitted, or any other provision to be made in a ship, other than that required by the present Convention, if it is

satisfied by trial thereof or otherwise that such fitting, material, appliance or apparatus, or provision, is at least as effective as that required by the Convention.

- (2) The Administration which allows a fitting, material, appliance or apparatus, or provision, other than that required by the present Convention, shall communicate to the Organization for circulation to the Contracting Governments particulars thereof, together with a report on any trials made.

Article 9

Approvals for Experimental Purposes

- (1) Nothing in the present Convention shall prevent an Administration from making specific approvals for experimental purposes in respect of a ship to which the Convention applies.
- (2) An Administration which makes any such approval shall communicate to the Organization for circulation to the Contracting Governments particulars thereof.

Article 10

Repairs, Alterations and Modifications

- (1) A ship which undergoes repairs, alterations, modifications and outfitting related thereto shall continue to comply with at least the requirements previously applicable to the ship. An existing ship in such a case shall not, as a rule, comply to a lesser extent with the requirements for a new ship than it did before.
- (2) Repairs, alterations and modifications of a major character and outfitting related thereto should meet the requirements for a new ship in so far as the Administration deems reasonable and practicable.

Article 11

Zones and Areas

- (1) A ship to which the present Convention applies shall comply with the requirements applicable to that ship in the zones and areas described in Annex II.
- (2) A port standing on the boundary line between two zones or areas shall be regarded as within the zone or area from or into which the ship arrives or departs

Article 12

Submersion

- (1) Except as provided in paragraphs (2) and (3) of this Article, the appropriate load lines on the sides of the ship corresponding to the season of the year and the zone or area in which the ship may be shall not be submerged at any time when the ship puts to sea, during the voyage or on arrival.
- (2) When a ship is in fresh water of unit density the appropriate load line may be submerged by the amount of the fresh water allowance shown on the International Load Line Certificate. Where

the density is other than unity, an allowance shall be made proportional to the difference between 1.025 and the actual density.

- (3) When a ship departs from a port situated on a river or inland waters, deeper loading shall be permitted corresponding to the weight of fuel and all other materials required for consumption between the point of departure and the sea.

Article 13

Surveys and Marking

The surveys and marking of ships, as regards the enforcement of the provisions of the present Convention and the granting of exemptions therefrom, shall be carried out by officers of the Administration. The Administration may, however, entrust the surveys and marking either to surveyors nominated for the purpose or to organizations recognized by it. In every case the Administration concerned fully guarantees the completeness and efficiency of the surveys and marking.

Article 14

Initial and Periodical Surveys and Inspections

- (1) A ship shall be subjected to the surveys specified below:
 - (1)(a) An initial survey before the ship is put in service, which shall include a complete inspection of its structure and equipment in so far as the ship is covered by the present Convention. The survey shall be such as to ensure that the arrangements, materials and scantlings fully comply with the requirements of the present Convention.
 - (1)(b) A renewal survey at intervals specified by the Administration but not exceed 5 years, except where paragraphs (2), (5), (6) and (7) of article 19 are applicable, which shall be such as to ensure that the structure, equipment, arrangements, materials and scantlings fully comply with the requirements of the present Convention.
 - (1)(c) An annual survey within 3 months before or after each anniversary date of the certificate to ensure that:
 - (1)(c)(i) alterations have not been made to the hull or superstructures which would affect the calculations determining the position of the load line;
 - (1)(c)(ii) the fittings and appliances for the protection of openings guard rails, freeing ports and means of access to crew's quarters are maintained in an effective condition;
 - (1)(c)(iii) the freeboard marks are correctly and permanently indicated;
 - (1)(c)(iv) the information required by regulation 10 is provided.
- (2) The annual surveys referred to in paragraph (1) (c) of this article shall be endorsed on the International Load Line Certificate or the International Load Line Exemption Certificate issued to a ship exempted under paragraph (2) of article 6 of the present Convention.

Article 15

Maintenance of Conditions after Survey

After any survey of the ship under Article 14 has been completed, no change shall be made in the structure, equipment, arrangements, material or scantlings covered by the survey, without the sanction of the Administration.

Article 16

Issue of Certificates

- (1) An International Load Line Certificate shall be issued to every ship which has been surveyed and marked in accordance with the present Convention.
- (2) An International Load Line Exemption Certificate shall be issued to any ship to which an exemption has been granted under and in accordance with paragraph (2) or (4) of Article 6.
- (3) Such certificates shall be issued by the Administration or by any person or organization duly authorized by it. In every case, the Administration assumes full responsibility for the certificate.

Article 17

Issue or Endorsement of Certificates by Another Government

- (1) A Contracting Government may at the request of another Contracting Government cause a ship to be surveyed and, if satisfied that the provisions of the present Convention are complied with, shall issue or authorize the issue of the International Load Line Certificate to the ship and, where appropriate, endorse or authorize the endorsement of the certificate on the ship in accordance with the present Convention.
- (2) A copy of the certificate, a copy of the survey report used for computing the freeboard, and a copy of the computations shall be transmitted as early as possible to the requesting Government.
- (3) A certificate so issued must contain a statement to the effect that it has been issued at the request of the Government of the State whose flag the ship is or will be flying and it shall have the same force and receive the same recognition as a certificate issued under Article 16.
- (4) No International Load Line Certificate shall be issued to a ship which is flying the flag of a State the Government of which is not a Contracting Government.

Article 18

Form of Certificates

The certificates shall be drawn up in the form corresponding to the models given in Annex III to the present Convention. If the language used is neither English nor French, the text shall include a translation into one of these languages.

Article 19

Duration and Validity of Certificates

- (1) An International Load Line Certificate shall be issued for a period specified by the Administration, which shall not exceed 5 years.
- (2)
 - (2)(a) Notwithstanding the requirements of paragraph (1), when the renewal survey is completed within 3 months before the expiry date of the existing certificate, the new certificate shall be valid from the date of completion of the renewal survey to a date not exceeding 5 years from the date of expiry of the existing certificate.
 - (2)(b) When the renewal survey is completed after the expiry date of the existing certificate, the new certificate shall be valid from the date of completion of the renewal survey to a date not exceeding 5 years from the date of expiry of the existing certificate.
 - (2)(c) When the renewal survey is completed more than 3 months before the expiry date of the existing certificate, the new certificate shall be valid from the date of completion of the renewal survey to a date not exceeding 5 years from the date of completion of the renewal survey.
- (3) If a certificate is issued for a period of less than 5 years, the Administration may extend the validity of a certificate beyond the expiry date to the maximum period specified in paragraph (1), provided that the annual surveys referred to in article 14 applicable when a certificate is issued for a period of 5 years are carried out as appropriate.
- (4) If, after the renewal survey referred to in paragraph (1)(b) of article 14, a new certificate cannot be issued to the ship before the expiry date of the existing certificate, the person or organisation carrying out the survey may extend the validity of the existing certificate for a period which shall not exceed 5 months. This extension shall be endorsed on the certificate, and shall be granted only where there have been no alterations in the structure, equipment, arrangements, materials or scantlings which affect the ship's freeboard.
- (5) If a ship at the time when a certificate expires is not in a port in which it is to be surveyed, the Administration may extend the period of validity of the certificate but this extension shall be granted only for the purpose of allowing the ship to complete its voyage to the port in which it is to be surveyed, and then only in cases where it appears proper and reasonable to do so. No certificate shall be extended for a period longer than 3 months, and a ship to which an extension is granted shall not, on its arrival in the port in which it is to be surveyed, be entitled by virtue of such extension to leave that port without having a new certificate. When the renewal survey is completed, the new certificate shall be valid to a date not exceeding 5 years from the date of expiry of the existing certificate before the extension was granted.
- (6) A certificate issued to a ship engaged on short voyages which has not been extended under the foregoing provisions of this article may be extended by the Administration for a period of grace of up to one month from the date of expiry stated on it. When the renewal survey is completed the new certificate shall be valid to a date not exceeding 5 years from the date of expiry of the existing certificate before the extension was granted.
- (7) In special circumstances, as determined by the Administration, a new certificate need not be dated from the date of expiry of the existing certificate as required by paragraphs (2), (5) and (6). In these special circumstances, the new certificate shall be valid to a date not exceeding 5 years from the date of completion of the renewal survey.
- (8) If an annual survey is completed before the period specified in article 14 then:

- (8)(a) the anniversary date shown on the certificate shall be amended by endorsement to a date which shall not be more than 3 months later than the date on which the survey was completed;
 - (8)(b) the subsequent annual survey required by article 14 shall be completed at the intervals prescribed by that article using the new anniversary date;
 - (8)(c) the expiry date may remain unchanged provided one or more annual surveys are carried out so that the maximum intervals between the surveys prescribed by article 14 are not exceeded.
- (9) An International Load Line Certificate shall cease to be valid if any of the following circumstances exist:
- (9)(a) material alterations have taken place in the hull or superstructures of the ship such as would necessitate the assignment of an increased freeboard;
 - (9)(b) the fittings and appliances mentioned in paragraph (1)(c) of article 14 are not maintained in an effective condition;
 - (9)(c) the certificate is not endorsed to show that the ship has been surveyed as provided in paragraph (1)(c) of article 14;
 - (9)(d) the structural strength of the ship is lowered to such an extent that the ship is unsafe.
- (10)
- (10)(a) The duration of an International Load Line Exemption Certificate issued by an Administration to a ship exempted under paragraph (2) of article 6 shall not exceed 5 years. Such certificate shall be subject to a renewal, endorsement, extension and cancellation procedure similar to that provided for an International Load Line Certificate under this article.
 - (10)(b) The duration of an International Load Line Exemption Certificate issued to a ship exempted under paragraph (4) of article 6 shall be limited to the single voyage for which it is issued.
- (11) A certificate issued to a ship by an Administration shall cease to be valid upon the transfer of such a ship to the flag of another State.

Article 20

Acceptance of Certificates

The certificates issued under the authority of a Contracting Government in accordance with the present Convention shall be accepted by the other Contracting Governments and regarded for all purposes covered by the present Convention as having the same force as certificates issued by them.

Article 21

Control

- (1) Ships holding a certificate issued under Article 16 or Article 17 are subject, when in the ports of other Contracting Governments, to control by officers duly authorized by such Governments. Contracting Governments shall ensure that such control is exercised as far as is reasonable and practicable with a view to verifying that there is on board a valid certificate under the present Convention. If there is a valid International Load Line Certificate on board the ship, such control shall be limited to the purpose of determining that:
- (1)(a) the ship is not loaded beyond the limits allowed by the certificate;

- (1)(b) the position of the load line of the ship corresponds with the certificate; and
- (1)(c) the ship has not been so materially altered in respect of the matters set out in sub-paragraphs (a) and (b) of paragraph (9) of Article 19 that the ship is manifestly unfit to proceed to sea without danger to human life. If there is a valid International Load Line Exemption Certificate on board, such control shall be limited to the purpose of determining that any conditions stipulated in that certificate are complied with.
- (2) If such control is exercised under sub-paragraph (c) of paragraph (1) of this Article, it shall only be exercised in so far as may be necessary to ensure that the ship shall not sail until it can proceed to sea without danger to the passengers or the crew.
- (3) In the event of the control provided for in this Article giving rise to intervention of any kind, the officer carrying out the control shall immediately inform in writing the Consul or the diplomatic representative of the State whose flag the ship is flying of this decision and of all the circumstances in which intervention was deemed to be necessary.

Article 22

Privileges

The privileges of the present Convention may not be claimed in favour of any ship unless it holds a valid certificate under the Convention.

Article 23

Casualties

- (1) Each Administration undertakes to conduct an investigation of any casualty occurring to ships for which it is responsible and which are subject to the provisions of the present Convention when it judges that such an investigation may assist in determining what changes in the Convention might be desirable.
- (2) Each Contracting Government undertakes to supply the Organization with the pertinent information concerning the findings of such investigations. No reports or recommendations of the Organization based upon such information shall disclose the identity or nationality of the ships concerned or in any manner fix or imply responsibility upon any ship or person.

Article 24

Prior Treaties and Conventions

- (1) All other treaties, conventions and arrangements relating to load line matters at present in force between Governments Parties to the present Convention shall continue to have full and complete effect during the terms thereof as regards:
 - (1)(a) ships to which the present Convention does not apply; and
 - (1)(b) ships to which the present Convention applies, in respect of matters for which it has not expressly provided.
- (2) To the extent, however, that such treaties, conventions or arrangements conflict with the provisions of the present Convention, the provisions of the present Convention shall prevail.

Article 25

Special Rules drawn up by Agreement

When in accordance with the present Convention special rules are drawn up by agreement among all or some of the Contracting Governments, such rules shall be communicated to the Organization for circulation to all Contracting Governments.

Article 26

Communication of Information

- (1) The Contracting Governments undertake to communicate to and deposit with the Organization:
 - (1)(a) a sufficient number of specimens of their certificates issued under the provisions of the present Convention for circulation to the Contracting Governments;
 - (1)(b) the text of the laws, decrees, orders, regulations and other instruments which shall have been promulgated on the various matters within the scope of the present Convention; and
 - (1)(c) a list of non-governmental agencies which are authorized to act in their behalf in the administration of load lien matter of circulation to the Contracting Governments.
- (2) Each Contracting Government agrees to make its strength standards avail to any other Contracting Government, upon request.

Article 27

Signature, Acceptance and Accession

- (1) The present Convention shall remain open for signature for three months from 5 April 1966 and shall thereafter remain open for accession. Governments of States Members of the United Nations, or of any of the Specialized Agencies, or of the International Atomic Energy Agency, or parties to the Statute of the International Court of Justice may become parties to the Convention by:
 - (1)(a) signature without reservation as to acceptance;
 - (1)(b) signature subject to acceptance followed by acceptance; or
 - (1)(c) accession.
- (2) Acceptance or accession shall be effected by the deposit of an instrument of acceptance or accession with the Organization which shall inform all Governments that have signed the Convention or acceded to it of each new acceptance or accession and of the date of its deposit.

Article 28

Coming into force

- (1) The present Convention shall come into force twelve months after the date on which not less than fifteen Governments of States, including seven each with not less than one million gross tons of shipping, have signed without reservation as to acceptance or deposited instruments of acceptance or accession in accordance with Article 27. The Organization shall inform all Governments which have signed or acceded to the present Convention of the date on which it comes into force.

- (2) For Governments which have deposited an instrument of acceptance of or accession to the present Convention during the twelve months mentioned in paragraph (1) of this Article, the acceptance or accession shall take effect on the coming into force of the present Convention or three months after the date of deposit of the instrument of acceptance or accession, whichever is the later date.
- (3) For Governments which have deposited an instrument of acceptance of or accession to the present Convention after the date on which it comes into force, the Convention shall come into force three months after the date of the deposit of such instrument.
- (4) After the date on which all the measures required to bring an amendment to the present Convention into force have been completed, or all necessary acceptances are deemed to have been given under sub-paragraph (b) of paragraph (2) of Article 29 in case of amendment by unanimous acceptance, any instrument of acceptance or accession deposited shall be deemed to apply to the Convention as amended.

Article 29

Amendments

- (1) The present Convention may be amended upon the proposal of a Contracting Government by any of the procedures specified in this Article.
- (2) Amendment by unanimous acceptance:
 - (2)(a) Upon the request of a Contracting Government, any amendment proposed by it to the present Convention shall be communicated by the Organization to all Contracting Governments for consideration with a view to unanimous acceptance.
 - (2)(b) Any such amendment shall enter into force twelve months after the date of its acceptance by all Contracting Governments unless an earlier date is agreed upon. A Contracting Government which does not communicate its acceptance or rejection of the amendment to the Organization within three years of its first communication by the latter shall be deemed to have accepted the amendment.
 - (2)(c) Any proposed amendment shall be deemed to be rejected if it is not accepted under sub-paragraph (b) of the present paragraph within three years after it has been first communicated to all Contracting Governments by the Organization.
- (3) Amendment after consideration in the Organization:
 - (3)(a) Upon the request of a Contracting Government, any amendment proposed by it to the present Convention will be considered in the Organization. If adopted by a majority of two-thirds of those present and voting in the Maritime Safety Committee of the Organization, such amendment shall be communicated to all Members of the Organization and all Contracting Governments at least six months prior to its consideration by the Assembly of the Organization
 - (3)(b) If adopted by a two-thirds majority of those present and voting in the Assembly, the amendment shall be communicated by the Organization to all Contracting Governments for their acceptance.
 - (3)(c) Such amendment shall come into force twelve months after the date on which it is accepted by two-thirds of the Contracting Governments. The amendment shall come into force with respect to all Contracting Governments except those which, before it comes into force, make a declaration that they do not accept the amendment.
 - (3)(d) The Assembly, by a two-thirds majority of those present and voting, including two-thirds of the Governments represented on the Maritime Safety Committee and present and

voting in the Assembly, may propose a determination at the time of its adoption that an amendment is of such an important nature that any Contracting Government which makes a declaration under sub-paragraph (c), and which does not accept the amendment within a period of twelve months after it comes into force, shall cease to be a party to the present Convention upon the expiry of that period. This determination shall be subject to the prior acceptance of two-thirds of the Contracting Governments to the present Convention.

- (3)(e) Nothing in this paragraph shall prevent the Contracting Government which first proposed action under this paragraph on an amendment to the present Convention from taking at any time such alternative action as it deems desirable in accordance with paragraph (2) or (4) of this Article.
- (4) Amendment by a conference:
 - (4)(a) Upon the request of a Contracting Government, concurred in by at least one-third of the Contracting Governments, a conference of Governments will be convened by the Organization to consider amendments to the present Convention.
 - (4)(b) Every amendment adopted by such a conference by a two-third majority of those present and voting of the Contracting Governments shall be communicated by the Organization to all Contracting Governments for their acceptance.
 - (4)(c) Such amendment shall come into force twelve months after the date on which it is accepted by two-thirds of the Contracting Governments. The amendment shall come into force with respect to all Contracting Governments except those which, before it comes into force, make a declaration that they do not accept the amendment.
 - (4)(d) By a two-thirds majority of those present and voting, a conference convened under sub-paragraph (a) may determine at the time of its adoption that an amendment is of such an important nature that any Contracting Government which makes a declaration under sub-paragraph (c), and which does not accept the amendment within a period of twelve months after it comes into force, shall cease to be a party to the present Convention upon the expiry of that period.
- (5) Any amendments to the present Convention made under this Article which relate to the structure of a ship shall apply only to ships the keels of which are laid, or which are at a similar stage of construction, on or after the date on which the amendment comes into force.
- (6) The Organization shall inform all Contracting Government of any amendments which come into force under this Article, together with the date on which each such amendment will come into force.
- (7) Any acceptance or declaration under this Article shall be made by a notification in writing to the Organization which shall notify all Contracting Governments of the receipt of the acceptance or declaration.

Article 30

Denunciation

- (1) The present Convention may be denounced by any Contracting Government at any time after the expiry of five years from the date on which the Convention comes into force for that Government.
- (2) Denunciation shall be effected by a notification in writing addressed to the Organization which shall inform all the other Contracting Governments of any such notification received and of the date of its receipt.

- (3) A denunciation shall take effect one year, or such longer period as may be specified in the notification, after its receipt by the Organization.

Article 31

Suspension

- (1) In case of hostilities or other extraordinary circumstances which affect the vital interests of a State the Government of which is a Contracting Government, that Government may suspend the operation of the whole or any part of the present Convention. The suspending Government shall immediately give notice of any such suspension to the Organization .
- (2) Such suspension shall not deprive other Contracting Governments of any right of control under the present Convention over the ships of the suspending Government when such ships are within their ports.
- (3) The suspending Government may at any time terminate such suspension and shall immediately give notice of such termination to the Organization.
- (4) The Organization shall notify all Contracting Governments of any suspension or termination of suspension under this Article.

Article 32

Territories

- (1)
 - (1)(a) The United Nations, in cases where they are the administering authority for a territory, or any Contracting Government responsible for the international relations of a territory, shall as soon as possible consult with such territory in an endeavour to extend the present Convention to that territory and may at any time by notification in writing to the Organization declare that the Present Convention shall extend to such territory.
 - (1)(b) The present Convention shall, from the date of the receipt of the notification or from such other date as may be specified in the notification, extend to the territory named therein .
- (2)
 - (2)(a) The United Nations, or any Contracting Government which has made a declaration under sub-paragraph (a) of paragraph (1) of this Article, at any time after the expiry of a period of five years from the date on which the Convention has been so extended to any territory, may by notification in writing to the Organization declare that the present Convention shall cease to extend to any such territory named in the notification.
 - (2)(b) The present Convention shall cease to extend to any territory mentioned in such notification one year, or such longer period as may be specified therein, after the date of receipt of the notification by the Organization.
- (3) The Organization shall inform all the Contracting Governments of the extension of the present Convention to any territories under paragraph (1) of this Article, and of the termination of any such extension under the provisions of paragraph (2), stating in each case the date from which the present Convention has been or will cease to be so extended.

Article 33

Registration

- (1) The present Convention shall be deposited with the Organization and the Secretary-General of the Organization shall transmit certified true copies thereof to all Signatory Governments and to all Governments which accede to the present Convention.
- (2) As soon as the present Convention comes into force it shall be registered by the Organization in accordance with Article 102 of the Charter of the United Nations.

Article 34

Languages

The present Convention is established in a single copy in the English and French languages, both texts being equally authentic. Official translations in the Russian and Spanish languages shall be prepared and deposited with the signed original.

IN WITNESS WHEREOF the undersigned being duly authorized by their respective Governments for that purpose have signed the present Convention .

**Notice from the Danish Maritime Authority B –
The Construction and Equipment, etc. of Ships**

Chapter B II-5 A(I-I)

**REVISED ARTICLES OF INTERNATIONAL CONVENTION ON LOAD
LINES, 1966**

INTERNATIONAL CONVENTION ON LOAD LINES, 1966

Annex I

REGULATIONS FOR DETERMINING LOAD LINES

CHAPTER I

GENERAL

Regulation 1 – Strength and intact stability of ship	1
Regulation 2 – Application	2
Regulation 2-1 – Authorization of recognized organizations	3
Regulation 3 – Definitions of terms used in the Annexes.....	3
Regulation 4 – Deck line.....	8
Regulation 5 – Load line mark.....	9
Regulation 6 – Lines to be used with the load line mark.....	9
Regulation 7 – Mark of assigning Authority	11
Regulation 8 – Details of marking	11
Regulation 9 – Verification of marks.....	11

The Regulations assume that the nature and stowage of the cargo, ballast, etc., are such as to secure sufficient stability of the ship and the avoidance of excessive structural stress.

The Regulations also assume that where there are international requirements relating to stability or subdivision, these requirements have been complied with.

Regulation 1 – Strength and intact stability of ship

- (1) The Administration shall satisfy itself that the general structural strength of the ship is adequate for the draught corresponding to the freeboard assigned.
- (2) A ship which is designed, constructed and maintained in compliance with the appropriate requirements of an organization, including a classification society, which is recognized by the

Administration or with applicable national standards of the Administration in accordance with the provisions of regulation 2-1, may be considered to provide an acceptable level of strength. The above provisions shall apply to all structures, equipment and fittings covered by this annex for which standards for strength and construction are not expressly provided.

(3) Compliance

(3)(a) Ships constructed before 1 July 2010 shall comply with an intact stability standard acceptable to the Administration.

(3)(b) Ships constructed on or after 1 July 2010 shall, as a minimum, comply with the requirements of part A of the 2008 IS Code.

Regulation 2 – Application

- (1) Ships with mechanical means of propulsion or lighters, barges or other ships without independent means of propulsion shall be assigned freeboards in accordance with the provisions of regulations 1 to 40, inclusive.
- (2) Ships carrying timber deck cargoes may be assigned, in addition to the freeboards prescribed in paragraph (1), timber freeboards in accordance with the provisions of regulations 41 to 45.
- (3) Ships designed to carry sail, whether as the sole means of propulsion or as a supplementary means, and tugs, shall be assigned freeboards in accordance with the provisions of regulations 1 to 40, inclusive. Additional freeboard may be required as determined by the Administration.
- (4) Ships of wood or of composite construction, or of other materials the use of which the Administration has approved, or ships whose constructional features are such as to render the application of the provisions of this Annex unreasonable or impracticable, shall be assigned freeboards as determined by the Administration.
- (5) Regulations 10 to 26, inclusive, shall apply to every ship to which a minimum freeboard is assigned. Relaxations from these requirements may be granted to a ship to which a greater than minimum freeboard is assigned, on condition that the Administration is satisfied with the safety conditions provided.
- (6) Where the assigned summer freeboard is increased such that the resulting draught is not more than that corresponding to a minimum summer freeboard for the same ship, but with an assumed freeboard deck located a distance below the actual freeboard deck at least equal to the standard superstructure height, the conditions of assignment in accordance with regulations 12, 14-1 through 20, 23, 24 and 25, as applicable, to the actual freeboard deck may be as required for a superstructure deck.
- (7) Unless expressly provided otherwise, the regulations of this Annex shall apply to ships the keels of which are laid or which are at a similar stage of construction on or after 1 January 2005.
- (8) For ships the keels of which are laid or which are at a similar stage of construction before 1 January 2005, the Administration shall ensure that the requirements which are applicable under the International Convention on Load Lines, 1966, as modified by the Protocol of 1988 relating thereto, adopted by the International Conference on Harmonized System of Survey and Certification, 1988, are complied with.
- (9) High-speed craft which comply with the requirements of the International Code of Safety for High-Speed Craft, 2000 (2000 HSC Code), adopted by the Maritime Safety Committee of the Organization by resolution MSC.97(73) and which have been surveyed and certified as provided in the Code shall be deemed to have complied with the requirements of this Annex. The certificates and permits issued under the 2000 HSC Code shall have the same force and the same recognition as the certificates issued under this Annex.

Regulation 2-1 – Authorization of recognized organizations

Organizations, including classification societies, referred to in article 13 of the Convention and regulation 1(2) shall comply with the guidelines adopted by the Organization by resolution A.739(18), as may be amended by the Organization, and the specifications adopted by the Organization by resolution A.789(19), as may be amended by the Organization, provided that such amendments are adopted, brought into force and take effect in accordance with the provisions of article VI of the present Protocol.

Regulation 3 – Definitions of terms used in the Annexes

(1) “Length”

- (1)(a) The length (L) shall be taken as 96% of the total length on a waterline at 85% of the least moulded depth measured from the top of the keel, or as the length from the fore side of the stem to the axis of the rudder stock on that waterline, if that be greater.
- (1)(b) For ships without a rudder stock, the length (L) is to be taken as 96% of the waterline at 85% of the least moulded depth.
- (1)(c) Where the stem contour is concave above the waterline at 85% of the least moulded depth, both the forward terminal of the total length and the fore-side of the stem respectively shall be taken at the vertical projection to that waterline of the aftermost point of the stem contour (above that waterline) (see figure 3.1).
- (1)(d) In ships designed with a rake of keel the waterline on which this length is measured shall be parallel to the designed waterline at 85% of the least moulded depth D_{min} , found by drawing a line parallel to the keel line of the vessel (including skeg) tangent to the moulded sheer line of the freeboard deck. The least moulded depth is the vertical distance measured from the top of the keel to the top of the freeboard deck beam at side at the point of tangency (see figure 3.2).

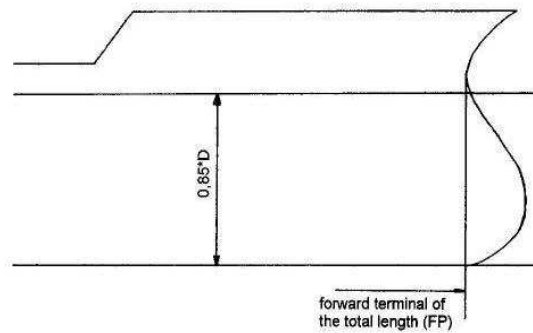

Figure 3.1

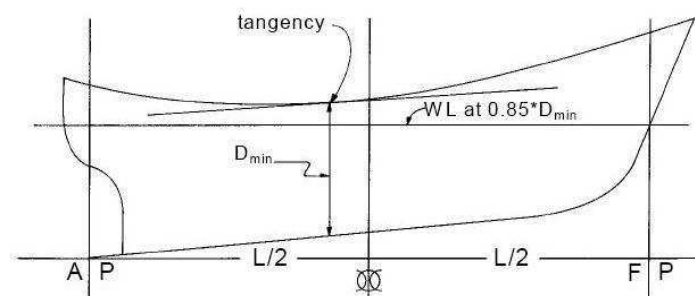

Figure 3.2

- (2) "Perpendiculars." The forward and after perpendiculars shall be taken at the forward and after ends of the length (L). The forward perpendicular shall coincide with the foreside of the stem on the waterline on which the length is measured.
- (3) "Amidships". Amidships is at the middle of the length (L).
- (4) "Breadth". Unless expressly provided otherwise, the breadth (B) is the maximum breadth of the ship, measured amidships to the moulded line of the frame in a ship with a metal shell and to the outer surface of the hull in a ship with a shell of any other material.
- (5) "Moulded depth"
 - (5)(a) The moulded depth is the vertical distance measured from the top of the keel to the top of the freeboard deck beam at side. In wood and composite ships the distance is measured from the lower edge of the keel rabbet. Where the form at the lower part of the midship section is of a hollow character, or where thick garboards are fitted, the distance is measured from the point where the line of the flat of the bottom continued inwards cuts the side of the keel.
 - (5)(b) In ships having rounded gunwales, the moulded depth shall be measured to the point of intersection of the moulded lines of deck and sides, the lines extending as though the gunwale were of angular design.
 - (5)(c) Where the freeboard deck is stepped and the raised part of the deck extends over the point at which the moulded depth is to be determined, the moulded depth shall be measured to a line of reference extending from the lower part of the deck along a line parallel with the raised part.
- (6) "Depth for freeboard" (D)

- (6)(a) The depth for freeboard (D) is the moulded depth amidships, plus the freeboard deck thickness at side.
- (6)(b) The depth for freeboard (D) in a ship having a rounded gunwale with a radius greater than 4% of the breadth (B) or having topsides of unusual form is the depth for freeboard of a ship having a midship section with vertical topsides and with the same round of beam and area of topside section equal to that provided by the actual midship section.
- (7) “Block coefficient”
 - (7)(a) The block coefficient (C_b) is given by:

$$C_b = \frac{\nabla}{L * B * d_1}, \text{ where}$$

∇ is the volume of the moulded displacement of the ship, excluding appendages, in a ship with a metal shell, and is the volume of displacement to the outer surface of the hull in a ship with a shell of any other material, both taken at a moulded draught of d_1 ; and where

d_1 is 85% of the least moulded depth.

- (7)(b) When calculating the block coefficient of a multi-hull craft, the full breadth (B) as defined in paragraph (4) is to be used and not the breadth of a single hull.
- (8) “Freeboard”. The freeboard assigned is the distance measured vertically downwards amidships from the upper edge of the deck line to the upper edge of the related load line.
- (9) “Freeboard deck”
 - (9)(a) The freeboard deck is normally the uppermost complete deck exposed to weather and sea, which has permanent means of closing all openings in the weather part thereof, and below which all openings in the sides of the ship are fitted with permanent means of watertight closing.
 - (9)(b) Lower deck as a freeboard deck

At the option of the owner and subject to the approval of the Administration, a lower deck may be designated as the freeboard deck provided it is a complete and permanent deck continuous in a fore and aft direction at least between the machinery space and peak bulkheads and continuous athwartships.

- (9)(b)(i) When this lower deck is stepped the lowest line of the deck and the continuation of that line parallel to the upper part of the deck is taken as the freeboard deck.
- (9)(b)(ii) When a lower deck is designated as the freeboard deck, that part of the hull which extends above the freeboard deck is treated as a superstructure so far as concerns the application of the conditions of assignment and the calculation of freeboard. It is from this deck that the freeboard is calculated.
- (9)(b)(iii) When a lower deck is designated as the freeboard deck, such deck as a minimum shall consist of suitably framed stringers at the ship sides and transversely at each watertight bulkhead which extends to the upper deck, within cargo spaces. The width of these stringers shall not be less than can be conveniently fitted having regard to the structure and the

operation of the ship. Any arrangement of stringers shall be such that structural requirement can also be met.

- (9)(c) Discontinuous freeboard deck, stepped freeboard deck.
 - (9)(c)(i) Where a recess in the freeboard deck extends to the sides of the ship and is in excess of one metre in length, the lowest line of the exposed deck and the continuation of that line parallel to the upper part of the deck is taken as the freeboard deck (see figure 3.3).
 - (9)(c)(ii) Where a recess in the freeboard deck does not extend to the sides of the ship, the upper part of the deck is taken as the freeboard deck.
 - (9)(c)(iii) Recesses not extending from side to side in a deck below the exposed deck, designated as the freeboard deck, may be disregarded, provided all openings in the weather deck are fitted with weathertight closing appliances.
 - (9)(c)(iv) Due regard shall be given to the drainage of exposed recesses and to free surface effects on stability.
 - (9)(c)(v) Provisions of subparagraphs (i) through (iv) are not intended to apply to dredgers, hopper barges or other similar types of ships with large open holds, where each case requires individual consideration.

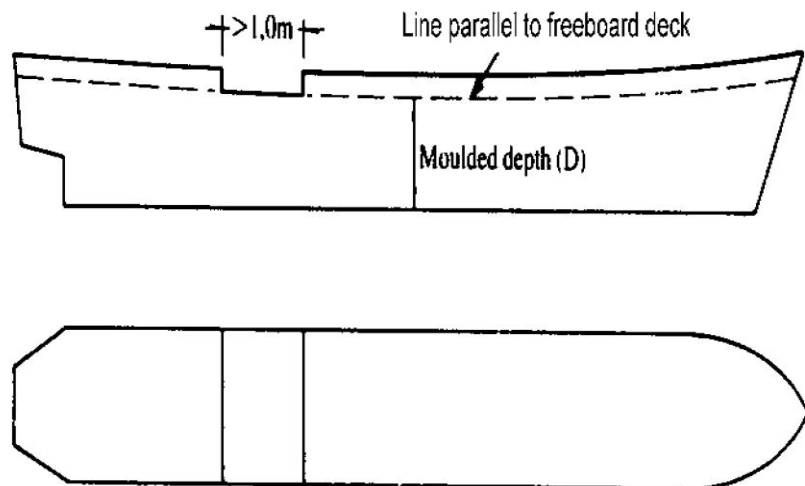

Figure 3.3

- (10) “Superstructure“
 - (10)(a) A superstructure is a decked structure on the freeboard deck, extending from side to side of the ship or with the side plating not being inboard of the shell plating more than 4% of the breadth (B).
 - (10)(b) An enclosed superstructure is a superstructure with:
 - (10)(b)(i) enclosing bulkheads of efficient construction;
 - (10)(b)(ii) access openings, if any, in these bulkheads fitted with doors complying with the requirements of regulation 12;

- (10)(b)(iii) all other openings in sides or ends of the superstructure fitted with efficient weathertight means of closing.

A bridge or poop shall not be regarded as enclosed unless access is provided for the crew starting from any point on the uppermost complete exposed deck or higher to reach machinery and other working spaces inside these superstructures by alternative means which are available at all times when bulkhead openings are closed.

- (10)(c) The height of a superstructure is the least vertical height measured at side from the top of the superstructure deck beams to the top of the freeboard deck beams.
- (10)(d) The length of a superstructure (S) is the mean length of the part of the superstructure which lies within the length (L).
- (10)(e) "Bridge". A bridge is a superstructure which does not extend to either the forward or after perpendicular.
- (10)(f) "Poop". A poop is a superstructure which extends from the after perpendicular forward to a point which is aft of the forward perpendicular. The poop may originate from a point aft of the aft perpendicular.
- (10)(g) "Forecastle". A forecastle is a superstructure which extends from the forward perpendicular aft to a point which is forward of the after perpendicular. The forecastle may originate from a point forward of the forward perpendicular.
- (10)(h) "Full superstructure". A full superstructure is a superstructure which, as a minimum, extends from the forward to the after perpendicular.
- (10)(i) "Raised quarterdeck". A raised quarterdeck is a superstructure which extends forward from the after perpendicular, generally has a height less than a normal superstructure, and has an intact front bulkhead (sidescuttles of the non-opening type fitted with efficient deadlights and bolted man hole covers) (see figure 3.4). Where the forward bulkhead is not intact due to doors and access openings, the superstructure is then to be considered as a poop.

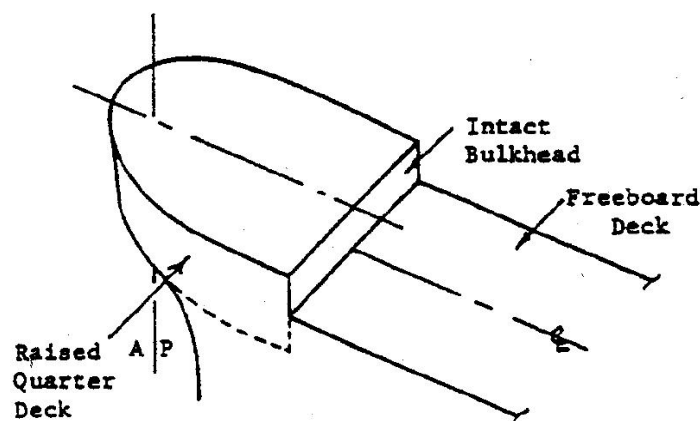

Figure 3.4

- (11) “Superstructure deck”. A superstructure deck is a deck forming the upper boundary of a superstructure.
- (12) “Flush deck ship”. A flush deck ship is one which has no superstructure on the freeboard deck.
- (13) “Weathertight”. Weathertight means that in any sea conditions water will not penetrate into the ship.
- (14) “Watertight”. Watertight means capable of preventing the passage of water through the structure in either direction with a proper margin of resistance under the pressure due to the maximum head of water which it might have to sustain.
- (15) “Well”. A well is any area on the deck exposed to the weather, where water may be entrapped. Wells are considered to be deck areas bounded on two or more sides by deck structures.
- (16) “2008 IS Code” means the International Code on Intact Stability, 2008, consisting of an introduction, part A (the provisions of which shall be treated as mandatory) and part B (the provisions of which shall be treated as recommendatory).

Regulation 4 – Deck line

The deck line is a horizontal line 300 mm in length and 25 mm in breadth. It shall be marked amidships on each side of the ship, and its upper edge shall normally pass through the point where the continuation outwards of the upper surface of the freeboard deck intersects the outer surface of the shell (as illustrated in figure 4.1), provided that the deck line may be placed with reference to another fixed point on the ship on condition that the freeboard is correspondingly corrected. The location of the reference point and the identification of the freeboard deck shall in all cases be indicated on the International Load Line Certificate.

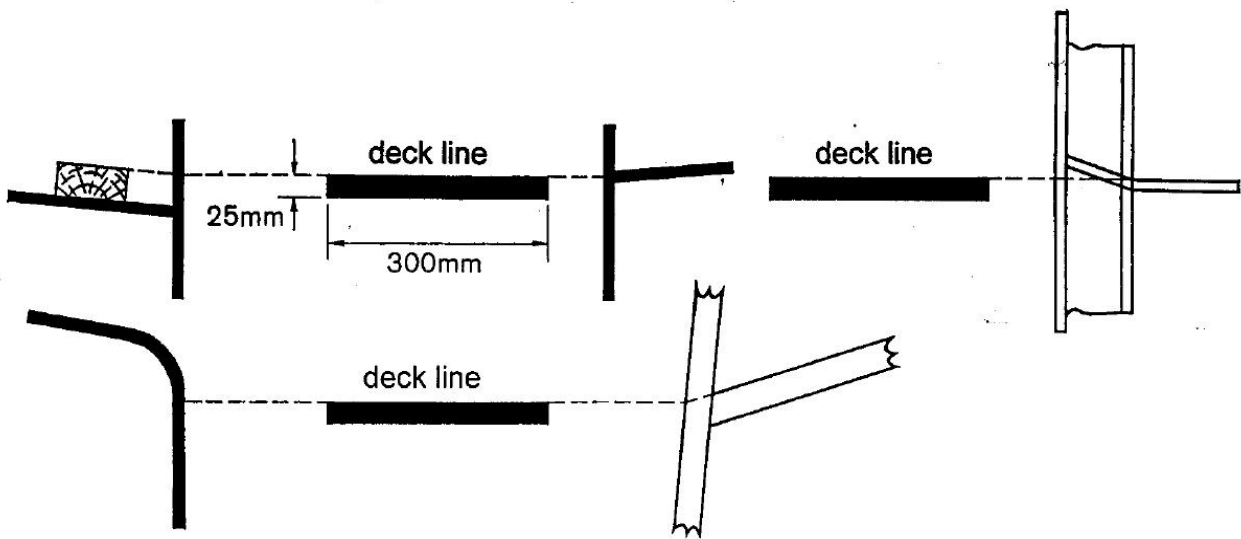

Figure 4.1 Deck line

Regulation 5 – Load line mark

The load line mark shall consist of a ring 300 mm in outside diameter and 25 mm wide which is intersected by a horizontal line 450 mm in length and 25 mm in breadth, the upper edge of which passes through the centre of the ring. The centre of the ring shall be placed amidships and at a distance equal to the assigned summer freeboard measured vertically below the upper edge of the deck line (as illustrated in figure 6.1).

Regulation 6 – Lines to be used with the load line mark

- (1) The lines which indicate the load line assigned in accordance with these regulations shall be horizontal lines 230 mm in length and 25 mm in breadth which extend forward of, unless expressly provided otherwise, and at right angles to, a vertical line 25 mm in breadth marked at a distance 540 mm forward of the centre of the ring (as illustrated in figure 6.1).
- (2) The following load lines shall be used:
 - (2)(a) The Summer Load Line indicated by the upper edge of the line which passes through the centre of the ring and also by a line marked S.
 - (2)(b) The Winter Load Line indicated by the upper edge of a line marked W.
 - (2)(c) The Winter North Atlantic Load Line indicated by the upper edge of a line marked WNA.
 - (2)(d) The Tropical Load Line indicated by the upper edge of a line marked T.
 - (2)(e) The Fresh Water Load Line in summer indicated by the upper edge of a line marked F. The Fresh Water Load Line in summer is marked abaft the vertical line. The difference between the Fresh Water Load Line in summer and the Summer Load Line is the allowance to be made for loading in fresh water at the other load lines.
 - (2)(f) The Tropical Fresh Water Load Line indicated by the upper edge of a line marked TF and marked abaft the vertical line.
- (3) If timber freeboards are assigned in accordance with these regulations, the timber load lines shall be marked in addition to ordinary load lines. These lines shall be horizontal lines 230 mm in length and 25 mm in breadth which extend abaft unless expressly provided otherwise, and are at right angles to, a vertical line 25 mm in breadth marked at a distance 540 mm abaft the centre of the ring (as illustrated in figure 6.2).

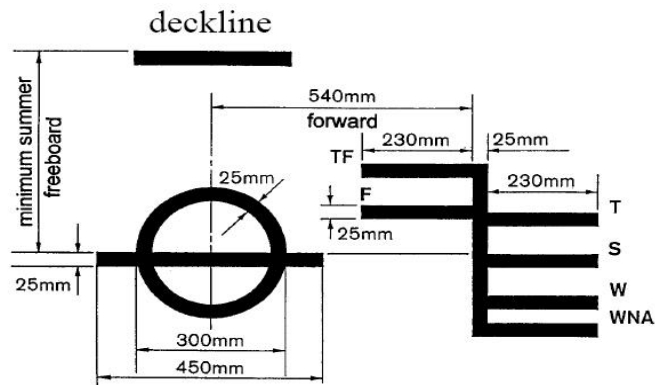

Figure 6.1 Load line mark and lines to be used with this mark

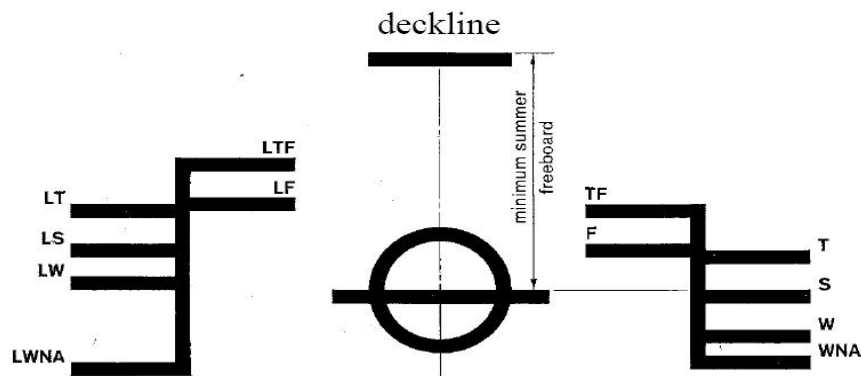

Figure 6.2 Timber load line mark and lines to be used with this mark

- (4) The following timber load lines shall be used:
- (4)(a) The Summer Timber Load Line indicated by the upper edge of a line marked LS.
 - (4)(b) The Winter Timber Load Line indicated by the upper edge of a line marked LW.
 - (4)(c) The Winter North Atlantic Timber Load Line indicated by the upper edge of a line marked LWNA.
 - (4)(d) The Tropical Timber Load Line indicated by the upper edge of a line marked LT.
 - (4)(e) The Fresh Water Timber Load Line in summer indicated by the upper edge of a line marked LF and marked forward of the vertical line. The difference between the Fresh Water Timber Load Line in summer and the Summer Timber Load Line is the allowance to be made for loading in fresh water at the other timber load lines.
 - (4)(f) The Tropical Fresh Water Timber Load Line indicated by the upper edge of a line marked LTF and marked forward of the vertical line.
- (5) Where the characteristics of a ship or the nature of the ship's service or navigational limits make any of the seasonal lines inapplicable, these lines may be omitted.
- (6) Where a ship is assigned a greater than minimum freeboard so that the load line is marked at a position corresponding to, or lower than, the lowest seasonal load line assigned at minimum freeboard in accordance with the present Protocol, only the Fresh Water Load Line need be marked.
- (7) Where a Winter North Atlantic Load Line is identical with the Winter Load Line corresponding to the same vertical line, this load line shall be marked W.

- (8) Alternative/additional load lines required by other international conventions in force may be marked at right angles to and abaft the vertical line specified in paragraph (1).

Regulation 7 – Mark of assigning Authority

The mark of the Authority by whom the load lines are assigned may be indicated alongside the load line ring above the horizontal line which passes through the centre of the ring, or above and below it. This mark shall consist of not more than four initials to identify the Authority's name, each measuring approximately 115 mm in height and 75 mm in width

Regulation 8 – Details of marking

The ring, lines and letters shall be painted in white or yellow on a dark ground or in black on a light ground. They shall also be permanently marked on the sides of the ships to the satisfaction of the Administration. The marks shall be plainly visible and, if necessary, special arrangements shall be made for this purpose.

Regulation 9 – Verification of marks

The International Load Line Certificate shall not be delivered to the ship until the officer or surveyor acting under the provisions of article 13 of the Convention has certified that the marks are correctly and permanently indicated on the ship's sides.

**Notice from the Danish Maritime Authority B –
The Construction and Equipment, etc. of Ships**

Chapter B II-5 A(I-II)

**REVISED ARTICLES OF INTERNATIONAL CONVENTION ON LOAD
LINES, 1966**

INTERNATIONAL CONVENTION ON LOAD LINES, 1966

ANNEX I

REGULATIONS FOR DETERMINING LOAD LINES

CHAPTER II

CONDITIONS OF ASSIGNMENT OF FREEBOARD

Regulation 10 Information to be supplied to the master.....	2
Regulation 11 Superstructure end bulkheads.....	2
Regulation 12 Doors	2
Regulation 13 Position of hatchways, doorways and ventilators.....	3
Regulation 14 Cargo and other hatchways	3
Regulation 14-1 Hatchway coamings	3
Regulation 15 Hatchways closed by portable covers and secured weathertight by tarpaulins and battening devices	3
Regulation 16 Hatchways closed by Weathertight Covers of Steel or other equivalent material ...	5
Regulation 17 Machinery space openings	7
Regulation 18 Miscellaneous openings in freeboard and superstructure decks.....	7
Regulation 19 Ventilators	8
Regulation 20 Air pipes	8
Regulation 21 Cargo ports and other similar openings.....	8
Regulation 22 Scuppers, inlets and discharges	9
Regulation 22-1 Garbage chutes	11
Regulation 22-2 Spurling pipes and cable lockers.....	12
Regulation 23 Side scuttles, windows and skylights	12
Regulation 24 Freeing ports.....	13
Regulation 25 Protection of the crew.....	17
Regulation 25-1 Means for safe passage of crew	17
Regulation 26 Special conditions of assignment for type 'A' ships	20

Regulation 10 Information to be supplied to the master

- (1) The master of every new ship shall be supplied with information to arrange for the loading and ballasting of his ship in such a way as to avoid the creation of any unacceptable stresses in the ship's structure, provided that this requirement need not apply to any particular length, design or class of ship where the Administration considers it to be unnecessary.
- (2) Information shall be provided to the master in a form that is approved by the Administration or a recognised organization. Stability information, and loading information also related to ship strength when required under paragraph (1), shall be carried on board at all times together with evidence that the information has been approved by the Administration.
- (3) A ship which is not required under the International Convention for Safety of Life at Sea in force to undergo an inclining test upon its completion shall:
 - (3)(a) be so inclined and the actual displacement and position of the centre of gravity shall be determined for the lightship condition;
 - (3)(b) if the Administration so approves, have its inclining test on completion dispensed with, provided basic stability data are available from the inclining test of a sister ship and it is shown to the satisfaction of the Administration that reliable stability information for the ship can be obtained from such basic data;
 - (3)(c) if the Administration decides that the performance of an inclining experiment is not practicable or safe or yields inaccurate results due to the specific proportions, arrangements, strength or hull form of a ship, have the ship's lightship characteristics determined by a detailed weight estimate confirmed by a lightweight survey;
 - (3)(d) have such information^{*} supplied for the use of its master as is necessary to enable the master, by rapid and simple processes, to obtain accurate guidance as to the stability of the ship under all conditions likely to be encountered in normal service; and
 - (3)(e) carry on board at all times its approved stability information together with evidence that the information has been approved by the Administration.
- (4) Where any alterations are made to a ship so as to materially affect the loading or stability information supplied to the master, amended information shall be provided. If necessary the ship shall be re-inclined.

Regulation 11 Superstructure end bulkheads

Bulkheads at exposed ends of enclosed superstructures shall be of an acceptable level of strength.

Regulation 12 Doors

- (1) All access openings in bulkheads at ends of enclosed superstructures shall be fitted with doors of steel or other equivalent material, permanently and strongly attached to the bulkhead, and framed, stiffened and fitted so that the whole structure is of equivalent strength to the unpierced bulkhead and weathertight when closed. The means for securing these doors weathertight shall consist of gaskets and clamping devices or other equivalent means and shall be permanently attached to the bulkhead or to the doors themselves, and the doors shall be so arranged that they can be operated from both sides of the bulkhead.
- (2) Unless otherwise permitted by the Administration, doors shall open outwards to provide additional security against the impact of the sea.

^{*} Refer to the Code on Intact Stability for All Types of Ships covered by IMO Instruments, adopted by the Organization by resolution A.749(18), as amended.

- (3) Except as otherwise provided in these regulations, the height of the sills of access openings in bulkheads at ends of enclosed superstructures shall be at least 380 mm above the deck.
- (4) Portable sills shall be avoided. However, in order to facilitate the loading/unloading of heavy spare parts or similar, portable sills may be fitted on the following conditions:
 - (4)(a) they shall be installed before the ship leaves port; and
 - (4)(b) they shall be gasketed and fastened by closely spaced through bolts

Regulation 13 Position of hatchways, doorways and ventilators

For the purpose of these regulations, two positions of hatchways, doorways and ventilators are defined as follows:

- Position 1 Upon exposed freeboard and raised quarter decks, and upon exposed superstructure decks situated forward of a point located a quarter of the ship's length from the forward perpendicular.
- Position 2 Upon exposed superstructure decks situated abaft a quarter of the ship's length from the forward perpendicular and located at least one standard height of superstructure above the freeboard deck. Upon exposed superstructure decks situated forward of a point located a quarter of the ship's length from the forward perpendicular and located at least two standard heights of superstructure above the freeboard deck.

Regulation 14 Cargo and other hatchways

- (1) The construction and means for securing the weathertightness of cargo and other hatchways in position 1 and 2 shall be at least equivalent to the requirements of regulation 16, unless the application of regulation 15 to such hatchways is granted by the Administration.
- (2) Coamings and hatchway covers to exposed hatchways on decks above the superstructure deck shall comply with the requirements of the Administration.

Regulation 14-1 Hatchway coamings

- (1) The coamings of hatchways shall be of substantial construction in accordance with their position, and their height above the deck shall be at least as follows:
 - (1)(a) 600 mm if in position 1; and
 - (1)(b) 450 mm if in position 2.
- (2) In the case of hatchways which comply with regulation 16(2) through (5), the height of these coamings may be reduced, or the coamings omitted entirely, on condition that the Administration is satisfied that the safety of the ship is not thereby impaired in any sea conditions.

Regulation 15 Hatchways closed by portable covers and secured weathertight by tarpaulins and battening devices

Hatchway covers

- (1) The width of each bearing surface for hatchway covers shall be at least 65 mm.
- (2) Where covers are made of wood, the finished thickness shall be at least 60 mm in association with a span of not more than 1.5 m.
- (3) Where covers are made of mild steel the strength shall be calculated in accordance with the requirement of regulation 16(2) to (4) and the product of the maximum stress thus calculated

and the factor 1.25 shall not exceed the minimum upper yield point strength of the material. They shall be so designed as to limit the deflection to not more than 0.0056 times the span under these loads.

Portable beams

- (4) Where portable beams for supporting hatchway covers are made of mild steel, the strength shall be calculated with assumed loads not less than 3.5 t/m² on hatchways in position 1 and not less than 2.6 t/m² on hatchways in position 2 and the product of the maximum stress thus calculated and the factor 1.47 shall not exceed the minimum upper yield point strength of the material. They shall be so designed as to limit the deflection to not more than 0.0044 times the span under these loads.
- (5) The assumed loads on hatchways in position 1 may be reduced to 2 t/m² for ships 24 m in length and shall be not less than 3.5 t/m² for ships 100 m in length. The corresponding loads on hatchways in position 2 may be reduced to 1.5 t/m² and 2.6 t/m², respectively. In all cases, values at intermediate lengths shall be obtained by linear interpolation.

Pontoon covers

- (6) Where pontoon covers used in place of portable beams and covers are made of mild steel, the strength shall be calculated in accordance with the requirement of regulation 16(2) to (4) and the product of the maximum stress thus calculated and the factor 1.47 shall not exceed the minimum upper yield point strength of the material. They shall be so designed as to limit the deflection to not more than 0.0044 times the span. Mild steel plating forming the tops of covers shall be not less in thickness than 1% of the spacing of stiffeners or 6 mm if that be greater.
- (7) The strength and stiffness of covers made of materials other than mild steel shall be equivalent to those of mild steel to the satisfaction of the Administration.

Carriers or sockets

- (8) Carriers or sockets for portable beams shall be of substantial construction, and shall provide means for the efficient fitting and securing of the beams. Where rolling types of beams are used, the arrangements shall ensure that the beams remain properly in position when the hatchway is closed.

Cleats

- (9) Cleats shall be set to fit the taper of the wedges. They shall be at least 65 mm wide and spaced not more than 600 mm centre to centre; the cleats along each side or end shall be not more than 150 mm from the hatch corners.

Battens and wedges

- (10) Battens and wedges shall be efficient and in good condition. Wedges shall be of tough wood or other equivalent material. They shall have a taper of not more than 1 in 6 and shall be not less than 13 mm thick at the toes.

Tarpaulins

- (11) At least two layers of tarpaulin in good condition shall be provided for each hatchway in position 1 or 2. The tarpaulins shall be waterproof and of ample strength. They shall be of a material of at least an approved standard weight and quality.

Securing of hatchway covers

- (12) For all hatchways in position 1 or 2 steel bars or other equivalent means shall be provided in order efficiently and independently to secure each section of hatchway covers after the tarpaulins are battened down. Hatchway covers of more than 1.5 m in length shall be secured by at least two such securing appliances.

Regulation 16 Hatchways closed by Weathertight Covers of Steel or other equivalent material

- (1) All hatchways in position 1 and 2 shall be fitted with hatch covers of steel or other equivalent material. Except as provided in regulation 14(2), such covers shall be weathertight and fitted with gaskets and clamping devices. The means for securing and maintaining weathertightness shall be to the satisfaction of the Administration. The arrangements shall ensure that the tightness can be maintained in any sea conditions, and for this purpose tests for tightness shall be required at the initial survey, and may be required at renewal and annual surveys or at more frequent intervals.

Hatch cover minimum design loads

- (2) For ships of 100 m in length and above:
(2)(a) Position 1 hatch covers located in the forward quarter of the ship's length shall be designed for wave loads at the forward perpendicular, calculated from the following equation:

$$\text{Load} = 5 + (\text{LH}-100)a \text{ t/m}^2$$

where :

L_H is L for ships of not more than 340 m but not less than 100 m in length and equal to 340 m for ships of more than 340 m in length;

L is the length of the ship (meters), as defined in regulation 3;

a is given in table 16.1,

and reduced linearly to 3.5 t/m² at the end of the forward quarter's length, as shown in table 16.2. The design load used for each hatch cover panel shall be that determined at its midpoint location.

- (2)(b) All other position 1 hatch covers shall be designed to 3.5 t/m².
(2)(c) Position 2 hatch covers shall be designed to 2.6 t/m².
(2)(d) Where a position 1 hatchway is located at least one superstructure standard height higher than the freeboard deck, it may be designed to 3.5 t/m².

Table 16.1

	a
Type B freeboard ships	0.0074
Ships assigned reduced freeboard by regulation 27(9) or (10)	0.0363

- (3) For ships 24 m in length:
- (3)(a) Position 1 hatch covers located in the forward quarter of the ship's length shall be designed for wave loads of 2.43 t/m^2 at the forward perpendicular and reduced linearly to 2 t/m^2 at the end of the forward quarter's length as shown in table 16.2. The design load used for each hatch cover panel shall be that determined at its midpoint location.
- (3)(b) All other position 1 hatch covers shall be designed to 2 t/m^2 .
- (3)(c) Position 2 hatch covers shall be designed to 1.5 t/m^2 .
- (3)(d) Where a position 1 hatchway is located at least one superstructure standard height higher than the freeboard deck, it may be designed to 2 t/m^2 .
- (4) For ships between 24 m and 100 m in length, and for positions between FP and $0.25L$, wave loads shall be obtained by linear interpolation of the values shown in table 16.2.

Table 16.2

	Longitudinal position		
	FP	0.25L	Aft of 0.25L
	L > 100 m		
Freeboard deck	Equation in 16(2)(a)	3.5 t/m^2	3.5 t/m^2
Superstructure deck	3.5 t/m^2	3.5 t/m^2	2.6 t/m^2
	L=100 m		
Freeboard deck	5 t/m^2	3.5 t/m^2	3.5 t/m^2
Superstructure deck	3.5 t/m^2	3.5 t/m^2	2.6 t/m^2
	L=24 m		
Freeboard deck	2.43 t/m^2	2 t/m^2	2 t/m^2
Superstructure deck	2 t/m^2	2 t/m^2	1.5 t/m^2

- (5) All hatch covers shall be designed such that:
- (5)(a) the product of the maximum stress determined in accordance with the above loads and the factor of 1.25 does not exceed the minimum upper yield point strength of the material in tension and the critical buckling strength in compression;
- (5)(b) the deflection is limited to not more than 0.0056 times the span;
- (5)(c) steel plating forming the tops of covers is not less in thickness than 1% of the spacing of stiffeners or 6 mm if that be greater; and
- (5)(d) an appropriate corrosion margin is incorporated.

Securing arrangements

- (6) The means for securing and maintaining weathertightness by other means than gaskets and clamping shall be to the satisfaction of the Administration.
- (7) Hatch covers which rest on coamings shall be located in their closed position by means capable of withstanding horizontally acting loads in any sea conditions.

Regulation 17 Machinery space openings

- (1) Machinery space openings in position 1 or 2 shall be properly framed and efficiently enclosed by steel casings of ample strength, and where the casings are not protected by other structures their strength shall be specially considered. Access openings in such casings shall be fitted with doors complying with the requirements of regulation 12(1), the sills of which shall be at least 600 mm above the deck if in position 1, and at least 380 mm above the deck if in position 2. Other openings in such casings shall be fitted with equivalent covers, permanently attached in their proper positions.
- (2) Where machinery casings are not protected by other structures, double doors (i.e. inner and outer doors complying with the requirements of regulation 12(1)) shall be required for ships assigned freeboards less than those based on table 28.2 of regulation 28. An inner sill of 230 mm in conjunction with the outer sill of 600 mm shall be provided.
- (3) Coamings of any fiddley, funnel or machinery space ventilator in an exposed position on the freeboard deck or superstructure deck shall be as high above the deck as is reasonable and practicable. In general, ventilators necessary to continuously supply the machinery space shall have coamings of sufficient height to comply with regulation 19(3), without having to fit weathertight closing appliances. Ventilators necessary to continuously supply the emergency generator room, if this is considered buoyant in the stability calculation or protecting opening leading below, shall have coamings of sufficient height to comply with regulation 19(3), without having to fit weathertight closing appliances.
- (4) Where due to ship size and arrangement this is not practicable, lesser heights for machinery space and emergency generator room ventilator coamings, fitted with weathertight closing appliances in accordance with regulation 19(4), may be permitted by the Administration in combination with other suitable arrangements to ensure an uninterrupted, adequate supply of ventilation to these spaces.
- (5) Fiddley openings shall be fitted with strong covers of steel or other equivalent material permanently attached in their proper positions and capable of being secured weathertight.

Regulation 18 Miscellaneous openings in freeboard and superstructure decks

- (1) Manholes and flush scuttles in position 1 or 2 or within superstructures other than enclosed superstructures shall be closed by substantial covers capable of being made watertight. Unless secured by closely spaced bolts, the covers shall be permanently attached.
- (2) Openings in freeboard decks other than hatchways, machinery space openings, manholes and flush scuttles shall be protected by an enclosed superstructure, or by a deckhouse or companionway of equivalent strength and weathertightness. Similarly, any such opening in an exposed superstructure deck, in the top of a deckhouse on the freeboard deck which gives access to a space below the freeboard deck or a space within an enclosed superstructure shall be protected by an efficient deckhouse or companionway. Doorways in such companionways or deckhouses that lead or give access to stairways leading below, shall be fitted with doors in accordance with regulation 12(1). Alternatively, if stairways within a deckhouse are enclosed within properly constructed companionways fitted with doors complying with regulation 12(1), the external door need not be weathertight.
- (3) Openings in the top of a deckhouse on a raised quarterdeck or superstructure of less than standard height, having a height equal to or greater than the standard quarterdeck height, shall be provided with an acceptable means of closing but need not be protected by an efficient deckhouse or companionway as defined in the regulation, provided that the height of the deckhouse is at least the standard height of a superstructure. Openings in the top of the deck

house on a deck house of less than a standard superstructure height may be treated in a similar manner.

- (4) In position 1 the height above the deck of sills to the doorways in companionways shall be at least 600 mm. In position 2 it shall be at least 380 mm.
- (5) Where access is provided from the deck above as an alternative to access from the freeboard deck in accordance with regulation 3(10)(b), then the height of sills into a bridge or poop shall be 380 mm. The same shall apply to deckhouses on the freeboard deck.
- (6) Where access is not provided from above, the height of the sills to doorways in deckhouses on the freeboard deck shall be 600 mm.
- (7) Where the closing appliances of access openings in superstructures and deckhouses are not in accordance with regulation 12(1), interior deck openings shall be considered exposed (i.e. situated in the open deck).

Regulation 19 Ventilators

- (1) Ventilators in position 1 or 2 to spaces below freeboard deck or decks of enclosed superstructures shall have coamings of steel or other equivalent material, substantially constructed and efficiently connected to the deck. Ventilators in position 1 shall have coamings of a height of at least 900 mm above the deck; in position 2 the coamings shall be of a height at least 760 mm above the deck. Where the coaming of any ventilator exceeds 900 mm in height it shall be specially supported.
- (2) Ventilators passing through superstructures other than enclosed superstructures shall have substantially constructed coamings of steel or other equivalent material at the freeboard deck.
- (3) Ventilators in position 1 the coamings of which extend to more than 4.5 m above the deck, and in position 2 the coamings of which extend to more than 2.3 m above the deck, need not be fitted with closing arrangements unless specifically required by the Administration.
- (4) Except as provided in paragraph (3), ventilator openings shall be provided with weathertight closing appliances of steel or other equivalent material. In ships of not more than 100 m in length the closing appliances shall be permanently attached; where not so provided in other ships, they shall be conveniently stowed near the ventilators to which they are to be fitted.
- (5) In exposed locations, the height of coamings may be increased to the satisfaction of the Administration.

Regulation 20 Air pipes

- (1) Where air pipes to ballast and other tanks extend above the freeboard or superstructure decks, the exposed parts of the pipes shall be of substantial construction; the height from the deck to the point where water may have access below shall be at least 760 mm on the freeboard deck and 450 mm on the superstructure deck.
- (2) Where these heights may interfere with the working of the ship, a lower height may be approved, provided that the Administration is satisfied that the closing arrangements and other circumstances justify a lower height.
- (3) Air pipes shall be provided with automatic closing devices.
- (4) Pressure-vacuum valves (PV valves) may be accepted on tankers

Regulation 21 Cargo ports and other similar openings

- (1) Cargo ports and other similar openings in the sides of ships below the freeboard deck shall be fitted with doors so designed as to ensure the same watertightness and structural integrity as the surrounding shell plating. Unless otherwise granted by the Administration, these opening

shall open outwards. The number of such openings shall be the minimum compatible with the design and proper working of the ship.

- (2) Unless otherwise permitted by the Administration, the lower edge of openings referred to in paragraph (1) shall not be below a line drawn parallel to the freeboard deck at side, which is at its lowest point at least 230 mm above the upper edge of the uppermost load line.
- (3) Where it is permitted to arrange cargo ports and other similar openings with their lower edge below the line specified in paragraph (2), additional features shall be fitted to maintain the watertight integrity.
- (4) The fitting of a second door of equivalent strength and watertightness is one acceptable arrangement. A leakage detection device shall be provided in the compartment between the two doors. Drainage of this compartment to the bilges, controlled by a readily accessible screw down valve, shall be arranged. The outer door shall open outwards.
- (5) Arrangements for bow doors and their inner doors, side doors and stern doors and their securings shall be in compliance with the requirements of a recognised organization, or with the applicable national standards of the Administration which provide an equivalent level of safety.

Regulation 22 Scuppers, inlets and discharges

- (1)
 - (1)(a) Discharges led through the shell either from spaces below the freeboard deck or from within superstructures and deckhouses on the freeboard deck fitted with doors complying with the requirements of regulation 12 shall, except as provided in paragraph (2), be fitted with efficient and accessible means for preventing water from passing inboard. Normally each separate discharge shall have one automatic non-return valve with a positive means of closing it from a position above the freeboard deck. Where the inboard end of the discharge pipe is located at least 0.01L above the Summer Load Line, the discharge may have two automatic non-return valves without positive means of closing. Where that vertical distance exceeds 0.02L, a single automatic non-return valve without positive means of closing may be accepted. The means for operating the positive action valve shall be readily accessible and provided with an indicator showing whether the valve is open or closed.
 - (1)(b) One automatic non-return valve and one sluice valve controlled from above the freeboard deck instead of one automatic non-return valve with a positive means of closing from a position above the freeboard deck, is acceptable.
 - (1)(c) Where two automatic non-return valves are required, the inboard valve shall always be accessible for examination under service conditions (i.e., the inboard valve shall be above the level of the Tropical Load Line). If this is not practicable, the inboard valve need not be located above the Tropical Load Line, provided that a locally controlled sluice valve is fitted between the two automatic non-return valves.
 - (1)(d) Where sanitary discharges and scuppers lead overboard through the shell in way of machinery spaces, a locally operated positive closing valve at the shell, together with a non-return valve inboard, is acceptable. The controls of the valves shall be in an easily accessible position.
 - (1)(e) The position of the inboard end of discharges shall be related to the Summer Timber Load Line when a timber freeboard is assigned.
 - (1)(f) The requirements for non-return valves are applicable only to those discharges which remain open during the normal operation of a ship. For discharges which are to be kept closed at sea, a single screw down valve operated from the deck is acceptable.

(1)(g) Table 22.1 provides the acceptable arrangements of scuppers, inlets and discharges.









Discharges coming from enclosed spaces below the freeboard deck or on the freeboard deck		Discharges coming from other spaces	
General requirement Reg. 22(1) where inboard end \leq 0.01L above SWL	Discharges through machinery space	outboard end > 450mm below FB deck or \leq 600mm above SWL Reg. 22(3)	otherwise Reg. 22(3)
Superstructure or Deckhouse Deck	Alternatives (Reg. 22(1)) where inboard end > 0.01L above SWL	outboard end > 450mm below FB deck or \leq 600mm above SWL Reg. 22(4)	
FB Deck	FB Deck	FB Deck	FB Deck
SWL	SWL	SWL	SWL
Symbols:  inboard end of pipes  outboard end of pipes  pipes terminating on the open deck	 non return valve without positive means of closing  non return valve with positive means of closing locally  valve controlled locally	 remote control  normal thickness  substantial thickness	

Table 22.1

- (2) Scuppers led through the shell from enclosed superstructures used for the carriage of cargo shall be permitted only where the edge of the freeboard deck is not immersed when the ship heels 5° either way. In other cases the drainage shall be led inboard in accordance with the requirements of the International Convention for the Safety of Life at Sea in force.
- (3) In manned machinery spaces, main and auxiliary sea inlets and discharges in connection with the operation of machinery may be controlled locally. The controls shall be readily accessible and shall be provided with indicators showing whether the valves are open or closed.
- (4) Scuppers and discharge pipes originating at any level and penetrating the shell either more than 450 mm below the freeboard deck or less than 600 mm above the Summer Load Line shall be provided with a non-return valve at the shell. This valve, unless required by

paragraph (2), may be omitted if the piping is of substantial thickness (see paragraph (7) below).

- (5) Scuppers leading from superstructures or deckhouses not fitted with doors complying with the requirements of regulation 12 shall be led overboard.
- (6) All shell fittings and the valves required by this regulation shall be of steel, bronze or other approved ductile material. Valves of ordinary cast iron or similar material are not acceptable. All pipes to which this regulation refers shall be of steel or other equivalent material to the satisfaction of the Administration.
- (7) Scupper and discharge pipes:
 - (7)(a) For scupper and discharge pipes, where substantial thickness is not required:
 - (7)(a)(i) for pipes having an external diameter equal to or less than 155 mm, the thickness shall not be less than 4.5 mm;
 - (7)(a)(ii) for pipes having an external diameter equal to or more than 230 mm, the thickness shall not be less than 6 mm.

Intermediate sizes shall be determined by linear interpolation.

- (7)(b) For scupper and discharge pipes, where substantial thickness is required:
 - (7)(b)(i) for pipes having an external diameter equal to or less than 80 mm, the thickness shall not be less than 7 mm;
 - (7)(b)(ii) for pipes having an external diameter of 180 mm, the thickness shall not be less than 10 mm;
 - (7)(b)(iii) for pipes having an external diameter equal to or more than 220 mm, the thickness shall not be less than 12.5 mm.

Intermediate sizes shall be determined by linear interpolation.

Regulation 22-1 Garbage chutes

- (1) Two gate valves controlled from the working deck of the chute instead of the nonreturn valve with a positive means of closing from a position above the freeboard deck which comply with the following requirements are acceptable:
 - (1)(a) the lower gate valve shall be controlled from a position above the freeboard deck. An interlock system between the two valves shall be arranged;
 - (1)(b) the inboard end shall be located above the waterline formed by an 8.5° heel to port or starboard at a draft corresponding to the assigned summer freeboard, but not less than 1,000 mm above the summer waterline. Where the inboard end exceeds 0.01L above the summer waterline, valve control from the freeboard deck is not required, provided the inboard gate valve is always accessible under service conditions; and
 - (1)(c) alternatively, the upper and lower gate valves may be replaced by a hinged weathertight cover at the inboard end of the chute together with a discharge flap. The cover and flap shall be arranged with an interlock so that the discharge flap cannot be operated until the hopper cover is closed.
- (2) The entire chute, including the cover, shall be constructed of material of substantial thickness.
- (3) The controls for the gate valves and/or hinged covers shall be clearly marked: "Keep closed when not in use".
- (4) Where the inboard end of the chute is below the freeboard deck of a passenger ship or the equilibrium waterlines of a cargo ship to which damage stability requirements apply, then:
 - (4)(a) the inboard end hinged cover/valve shall be watertight;

- (4)(b) the valve shall be a screw-down non-return valve fitted in an easily accessible position above the deepest load line; and
- (4)(c) the screw-down non-return valve shall be controlled from a position above the bulkhead deck and provided with open/closed indicators. The valve control shall be clearly marked: "Keep closed when not in use".

Regulation 22-2 Spurling pipes and cable lockers

- (1) Spurling pipes and cable lockers shall be watertight up to the deck exposed to weather.
- (2) Where means of access are provided, they shall be closed by a substantial cover and secured by closely spaced bolts.
- (3) Spurling pipes through which anchor cables are led shall be provided with permanently attached closing appliances to minimize water ingress.

Regulation 23 Side scuttles, windows and skylights

- (1) Side scuttles and windows, together with their glasses, deadlights and storm covers^{*}, if fitted, shall be of an approved design and substantial construction. Non-metallic frames are not acceptable.
- (2) Side scuttles are defined as being round or oval openings with an area not exceeding 0.16 m². Round or oval openings having areas exceeding 0.16 m² shall be treated as windows.
- (3) Windows are defined as being rectangular openings generally, having a radius at each corner relative to the window size and round or oval openings with an area exceeding 0.16 m².
- (4) Side scuttles to the following spaces shall be fitted with hinged inside deadlights:
 - (4)(a) spaces below freeboard deck;
 - (4)(b) spaces within the first tier of enclosed superstructures; and
 - (4)(c) first tier deckhouses on the freeboard deck protecting openings leading below or considered buoyant in stability calculations.

Deadlights shall be capable of being closed and secured watertight if fitted below the freeboard deck and weathertight if fitted above.

- (5) Side scuttles shall not be fitted in such a position that their sills are below a line drawn parallel to the freeboard deck at side and having its lowest point 2.5% of the breadth (B), or 500 mm, whichever is the greatest distance, above the Summer Load Line (or Timber Summer Load Line if assigned).
- (6) If the required damage stability calculations indicate that the side scuttles would become immersed at any intermediate stage of flooding or the final equilibrium waterline, they shall be of the non-opening type.
- (7) Windows shall not be fitted in the following locations:
 - (7)(a) below the freeboard deck;
 - (7)(b) in the first tier end bulkheads or sides of enclosed superstructures; or
 - (7)(c) in first tier deckhouses that are considered buoyant in the stability calculations.
- (8) Side scuttles and windows at the side shell in the second tier shall be provided with hinged inside deadlights capable of being closed and secured weathertight if the superstructure protects direct access to an opening leading below or is considered buoyant in the stability calculations.

^{*} Deadlights are fitted to the inside of windows and side scuttles, while storm covers are fitted to the outside of windows, where accessible, and may be hinged or portable.

- (9) Side scuttles and windows in side bulkheads set inboard from the side shell in the second tier which protect direct access below to spaces listed in paragraph (4) shall be provided with either hinged inside deadlights or, where they are accessible, permanently attached external storm covers which are capable of being closed and secured weathertight.
- (10) Cabin bulkheads and doors in the second tier and above separating side scuttles and windows from a direct access leading below or the second tier considered buoyant in the stability calculations may be accepted in place of deadlights or storm covers fitted to the side scuttles and windows.
- (11) Deckhouses situated on a raised quarter deck or on the deck of a superstructure of less than standard height may be regarded as being in the second tier as far as the requirements for deadlights are concerned, provided that the height of the raised quarter deck or superstructure is equal to or greater than the standard quarter deck height.
- (12) Fixed or opening skylights shall have a glass thickness appropriate to their size and position as required for side scuttles and windows. Skylight glasses in any position shall be protected from mechanical damage and, where fitted in position 1 or 2, shall be provided with permanently attached deadlights or storm covers.

Regulation 24 Freeing ports

- (1)
 - (1)(a) Where bulwarks on the weather portions of freeboard or superstructure decks form wells, ample provision shall be made for rapidly freeing the decks of water and for draining them.
 - (1)(b) Except as provided in paragraphs (1)(c) and (2), the minimum freeing port area (A) on each side of the ship for each well on the freeboard deck shall be that given by the following formulae in cases where the sheer in way of the well is standard or greater than standard.

The minimum area for each well on superstructure decks shall be one-half of the area given by the following formulae:

Where the length of bulwark (ℓ) in the well is 20 m or less:

$$A = 0.7 + 0.035 \ell \text{ m}^2;$$

where ℓ exceeds 20 m:

$$A = 0.07 \ell \text{ m}^2.$$

ℓ need in no case be taken as greater than 0.7L.

If the bulwark is more than 1.2 m in average height, the required area shall be increased by 0.004 m² per metre of length of well for each 0.1 m difference in height. If the bulwark is less than 0.9 m in average height, the required area may be decreased by 0.004 m² per m of length of well for each 0.1 m difference in height.

- (1)(c) In ships with no sheer, the area calculated according to paragraph (b) shall be increased by 50%. Where the sheer is less than the standard, the percentage shall be obtained by linear interpolation.

- (1)(d) On a flush deck ship with a deckhouse amidships having a breadth at least 80% of the beam of the ship and the passageways along the side of the ship not exceeding 1.5 m in width, two wells are formed. Each shall be given the required freeing port area based upon the length of each well.
 - (1)(e) Where a screen bulkhead is fitted completely across the ship at the forward end of a midship deckhouse, the exposed deck is divided into two wells and there is no limitation on the breadth of the deckhouse.
 - (1)(f) Wells on raised quarterdecks shall be treated as being on freeboard decks.
 - (1)(g) Gutter bars greater than 300 mm in height fitted around the weather decks of tankers in way of cargo manifolds and cargo piping shall be treated as bulwarks. Freeing ports shall be arranged in accordance with this regulation. Closures attached to the freeing ports for use during loading and discharge operations are to be arranged in such a way that jamming cannot occur while at sea.
- (2) Where a ship fitted with a trunk does not comply with the requirements of regulation 36(1)(e) or where continuous or substantially continuous hatchway side coamings are fitted between detached superstructures, the minimum area of the freeing port openings shall be calculated from the following table:

BREADTH OF HATCHWAY OR TRUNK IN RELATION OF THE BREADTH OF SHIP	AREA OF FREEING PORTS IN RELATION TO THE TOTAL AREA OF THE BULWARKS
40% or less	20%
75% or more	10%

The area of freeing ports at intermediate breadths shall be obtained by linear interpolation.

- (3) The effectiveness of the freeing area in bulwarks required by paragraph (1) depends on the free flow area across the deck of a ship.

The free flow area on deck is the net area of gaps between hatchways, and between hatchways and superstructures and deckhouses up to the actual height of the bulwark.

The freeing port area in bulwarks shall be assessed in relation to the net free flow area as follows:

- (3)(a) If the free flow area is not less than the freeing area calculated from paragraph (2) as if the hatchway coamings were continuous, then the minimum freeing port area calculated from paragraph (1) shall be deemed sufficient.
- (3)(b) If the free flow area is equal to, or less than the area calculated from paragraph (1), the minimum freeing area in the bulwarks shall be determined from paragraph (2).
- (3)(c) If the free flow area is smaller than calculated from paragraph (2), but greater than calculated from paragraph (1), the minimum freeing area in the bulwark shall be determined from the following formula:

$$F = F_1 + F_2 - fp \text{ m}^2$$

where:

F_1 is the minimum freeing area calculated from paragraph (1);

F_2 is the minimum freeing area calculated from paragraph (2); and

f_p is the total net area of passages and gaps between hatch ends and superstructures or deckhouses up to the actual height of bulwark.

- (4) In ships having superstructures on the freeboard deck or superstructure decks, which are open at either or both ends to wells formed by bulwarks on the open decks, adequate provision for freeing the open spaces within the superstructures shall be provided.

The minimum freeing port area on each side of the ship for the open superstructure (A_s) and for the open well (A_w), shall be calculated in accordance with the following procedure:

- (4)(a) Determine the total well length (l_t) equal to the sum of the length of the open deck enclosed by bulwarks (l_w) and the length of the common space within the open superstructure (l_s).
- (4)(b) To determine A_s :
- (4)(b)(i) calculate the freeing port area (A) required for an open well of length l_t in accordance with paragraph (1) with standard height bulwark assumed;
- (4)(b)(ii) multiply by a factor of 1.5 to correct for the absence of sheer, if applicable, in accordance with paragraph (1)(c);
- (4)(b)(iii) multiply by the factor (b_o / l_t) to adjust the freeing port area for the breadth (b_o) of the openings in the end bulkhead of the enclosed superstructure;
- (4)(b)(iv) to adjust the freeing port area for that part of the entire length of the well which is enclosed by the open superstructure, multiply by the factor:

$$1 - \left(\frac{l_w}{l_t} \right)^2$$

where l_w and l_t are defined in paragraph (4)(a);

- (4)(b)(v) (v) to adjust the freeing port area for the distance of the well deck above the freeboard deck, for decks located more than $0.5 h_s$ above the freeboard deck, multiply by the factor:

$$0.5 \left(\frac{h_s}{h_w} \right)$$

where h_w is the distance of the well deck above the freeboard deck and

h_s is one standard superstructure height.

- (4)(c) To determine A_w :
- (4)(c)(i) the freeing port area for the open well (A_w) shall be calculated in accordance with paragraph (b)(i), using l_w to calculate a nominal freeing

port area (A'), and then adjusted for the actual height of the bulwark (h_b) by the application of one of the following area corrections, whichever is applicable:

for bulwarks greater than 1.2 m in height:

$$A_c = l_w \left(\frac{h_b - 1.2}{0.10} \right) (0.004) \text{ m}^2$$

for bulwarks less than 0.9 m in height:

$$A_c = l_w \left(\frac{h_b - 0.9}{0.10} \right) (0.004) \text{ m}^2$$

for bulwarks between 1.2 m and 0.9 m in height there is no correction (i.e. $A_c = 0$);

(4)(c)(ii) the corrected freeing port area ($A_w = A' + A_c$) shall then be adjusted for absence of sheer, if applicable, and height above freeboard deck as in paragraphs (b)(ii) and (b)(v), using h_s and h_w .

(4)(d) The resulting freeing port areas for the open superstructure (A_s) and for the open well (A_w) shall be provided along each side of the open space covered by the open superstructure and each side of the open well, respectively.

(4)(e) The above relationships are summarised by the following equations, assuming l_t , the sum of l_w and l_s , is greater than 20 m:

freeing port area A_w for the open well:

$$A_w = (0.071 l_w + A_c) \left(\frac{0.5 h_s}{h_w} \right);$$

freeing port area A_s for the open superstructure:

$$A_s = (0.07 l_s) \left(\frac{b_o}{l_t \left(1 - \left(\frac{l_w}{l_t} \right)^2 \right)} \right) \left(\frac{0.5 h_s}{h_w} \right);$$

where l_t is 20 m or less, the basic freeing port area is $A = 0.7 + 0.035 l_t$ in accordance with paragraph (1).

(5) The lower edges of freeing ports shall be as near the deck as practicable. Two thirds of the freeing port area required shall be provided in the half of the well nearest the lowest point of the sheer curve. One third of the freeing port area required shall be evenly spread along the remaining length of the well. With zero or little sheer on the exposed freeboard deck or an

exposed superstructure deck the freeing port area shall be evenly spread along the length of the well.

- (6) All freeing port openings in the bulwarks shall be protected by rails or bars spaced approximately 230 mm apart. If shutters are fitted to freeing ports, ample clearance shall be provided to prevent jamming. Hinges shall have pins or bearings of non-corrodible material. Shutters shall not be fitted with securing appliances.

Regulation 25 Protection of the crew

- (1) The deckhouses used for the accommodation of the crew shall be constructed to an acceptable level of strength.
- (2) Guard rails or bulwarks shall be fitted around all exposed decks. The height of the bulwarks or guard rails shall be at least 1 m from the deck, provided that where this height would interfere with the normal operation of the ship, a lesser height may be approved, if the Administration is satisfied that adequate protection is provided.
- (3) Guard rails fitted on superstructure and freeboard decks shall have at least three courses. The opening below the lowest course of the guard rails shall not exceed 230 mm. The other courses shall be not more than 380 mm apart. In the case of ships with rounded gunwales the guard rail supports shall be placed on the flat of the deck. In other locations, guardrails with at least two courses shall be fitted. Guard rails shall comply with the following provisions:
 - (3)(a) fixed, removable or hinged stanchions shall be fitted about 1.5 m apart. Removable or hinged stanchions shall be capable of being locked in the upright position;
 - (3)(b) at least every third stanchion shall be supported by a bracket or stay;
 - (3)(c) where necessary for the normal operation of the ship, steel wire ropes may be accepted in lieu of guard rails. Wires shall be made taut by means of turnbuckles; and
 - (3)(d) where necessary for the normal operation of the ship, chains fitted between two fixed stanchions and/or bulwarks are acceptable in lieu of guard rails.
- (4) Satisfactory means for safe passage required by regulation 25-1 (in the form of guard rails, lifelines, gangways or underdeck passages, etc.) shall be provided for the protection of the crew in getting to and from their quarters, the machinery space and any other spaces used in the essential operation of the ship.
- (5) Deck cargo carried on any ship shall be so stowed that any opening which is in way of the cargo and which gives access to and from the crew's quarters, the machinery space and all other parts used in the essential operation of the ship can be closed and secured against water ingress. Protection for the crew in the form of guard rails or lifelines shall be provided above the deck cargo if there is no convenient passage on or below the deck of the ship.

Regulation 25-1 Means for safe passage of crew

- (1) The safe passage of crew shall be provided by at least one of the means prescribed in table 25-1.1 below:

Type of ship	Locations of access in ship	Assigned summer freeboard	Acceptable arrangements according to type of freeboard assigned***			
			Type 'A'	Type 'B-100'	Type 'B-60'	Type 'B' and 'B+'
All ships other than oil tankers*, chemical tankers* and gas carriers*	1.1 Access to midship quarters	≤ 3,000 mm	(a)	(a)	(a)	(a)
	1.1.1 Between poop and bridge, or		(b)	(b)	(b)	(b)
	1.1.2 Between poop and deckhouse containing living accommodation or navigating equipment, or both.	> 3,000 mm	(e)	(e)	(c)(i)	(c)(i)
					(e)	(c)(ii)
					(f)(i)	(c)(iv)
			(a)	(a)	(a)	(d)(i)
			(b)	(b)	(b)	(d)(ii)
			(e)	(e)	(c)(i)	(d)(iii)
				(c)(ii)	(e)	
				(e)	(f)(i)	
				(f)(i)	(f)(ii)	
				(f)(ii)	(f)(iv)	
All ships other than oil tankers*, chemical tankers* and gas carriers*	1.2 Access to ends	≤ 3,000 mm	(a)	(a)	(a)	
	1.2.1 Between poop and bow (if there is no bridge).		(b)	(b)	(b)	
	1.2.2 Between bridge and bow, or	> 3,000 mm	(c)(i)	(c)(i)	(c)(i)	
			(e)	(c)(ii)	(c)(ii)	
	1.2.3 Between a deckhouse containing living accommodation or navigating equipment, or both, and bow, or		(f)(i)	(e)	(e)	
	1.2.4 In the case of a flush deck ship, between crew accommodation and the forward and after ends of ship.			(f)(i)	(f)(i)	
				(f)(ii)	(f)(ii)	
			(a)	(a)	(a)	
		(b)	(b)	(b)		
		(c)(i)	(c)(i)	(c)(i)		
		(d)(i)	(c)(ii)	(c)(ii)		
		(e)	(d)(i)	(c)(iv)		
		(f)(i)	(d)(ii)	(d)(i)		
			(e)	(d)(ii)		
			(f)(i)	(d)(iii)		
			(f)(ii)	(e)		
				(f)(i)		
				(f)(ii)		
				(f)(iv)		
Oil tankers*, chemical tankers* and gas carriers*	2.1 Access to bow	≤ (A _f + H _s)**				
	2.1.1 Between poop and bow or		(a)			
	2.1.2 Between a deckhouse containing living accommodation or navigating equipment, or both, and bow, or	> (A _f + H _s)**	(e)			
	2.1.3 In the case of a flush deck ship, between crew accommodation and the forward ends of ship.		(f)(i)			
		(f)(v)				
			(a)			
			(e)			
			(f)(i)			
			(f)(ii)			
2.2 Access to after end	In the case of a flush deck ship, between crew accommodation and the after end of ship.	As required in 1.2.4 for other types of ships				

Table 25-1.1

* Oil tankers, chemical tankers and gas carriers as defined in regulations II-1/2.12, VII/8.2 and VII/11.2, respectively, of the International Convention for the Safety of Life at Sea, 1974, as amended.

** A_f: the minimum summer freeboard calculated as type 'A' ship regardless of the type freeboard actually assigned.

H_s: the standard height of superstructure as defined in regulation 33.

*** Arrangements (a)-(f) are described in paragraph (2) below. Locations (i)-(v) are described in paragraph (3) below.

(2) Acceptable arrangements referred to in table 25-1.1 are defined as follows:

- (2)(a) A well lighted and ventilated under-deck passageway (with a clear opening of at least 0.8 m wide and 2 m high), as close as practicable to the freeboard deck, connecting and providing access to the locations in question.
- (2)(b) A permanent and efficiently constructed gangway, fitted at or above the level of the superstructure deck, on or as near as practicable to the centre line of the ship, providing a continuous platform at least 0.6 m in width and a non-slip surface and with guard rails extending on each side throughout its length. Guard rails shall be at least 1 m high with three courses and constructed as required in regulation 25(3). A foot-stop shall be provided.
- (2)(c) A permanent walkway at least 0.6 m in width, fitted at freeboard deck level and consisting of two rows of guard rails with stanchions spaced not more than 3 m. The number of courses of rails and their spacing shall be in accordance with regulation 25(3). On type 'B' ships, hatchway coamings not less than 0.6 m in height may be accepted as forming one side of the walkway, provided that two rows of guard rails are fitted between the hatchways.
- (2)(d) A wire rope lifeline not less than 10 mm in diameter, supported by stanchions not more than 10 m apart, or a single hand rail or wire rope attached to hatch coamings, continued and supported between hatchways.
- (2)(e) A permanent gangway that is:
 - (2)(e)(i) located at or above the level of the superstructure deck;
 - (2)(e)(ii) located on or as near as practicable to the centre line of the ship;
 - (2)(e)(iii) located so as not to hinder easy access across the working areas of the deck;
 - (2)(e)(iv) providing a continuous platform at least 1 m in width;
 - (2)(e)(v) constructed of fire resistant and non-slip material;
 - (2)(e)(vi) fitted with guard rails extending on each side throughout its length; guard rails shall be at least 1 m high with courses as required by regulation 25(3) and supported by stanchions spaced not more than 1.5 m apart;
 - (2)(e)(vii) provided with a foot-stop on each side;
 - (2)(e)(viii) having openings, with ladders where appropriate, to and from the deck. Openings shall not be more than 40 m apart; and
 - (2)(e)(ix) having shelters set in way of the gangway at intervals not exceeding 45 m if the length of the exposed deck to be traversed exceeds 70 m. Every such shelter shall be capable of accommodating at least one person and be so constructed as to afford weather protection on the forward, port and starboard sides.
- (2)(f) A permanent walkway located at the freeboard deck level, on or as near as practicable to the centre line of the ship, having the same specifications as those for a permanent gangway listed in (e), except for foot-stops. On type 'B' ships (certified for the carriage of liquids in bulk) with a combined height of hatch coaming and fitted hatch cover of not less than 1 m in height, the hatchway coamings may be accepted as forming one side of the walkway, provided that two rows of guard rails are fitted between the hatchways.
- (3) Permitted transverse locations for arrangements in paragraphs (2)(c), (d) and (f) above, where appropriate:
 - (3)(a)(i) at or near the centre line of the ship; or fitted on hatchways at or near the centre line of the ship;
 - (3)(a)(ii) fitted on each side of the ship;

- (3)(a)(iii) fitted on one side of the ship, provision being made for fitting on either side;
 - (3)(a)(iv) fitted on one side of the ship only;
 - (3)(a)(v) fitted on each side of the hatchways, as near to the centre line as practicable.
- (4)
- (4)(a) Where wire ropes are fitted, turnbuckles shall be provided to ensure their tautness.
 - (4)(b) Where necessary for the normal operation of the ship, steel wire ropes may be accepted in lieu of guard rails.
 - (4)(c) Where necessary for the normal operation of the ship, chains fitted between two fixed stanchions are acceptable in lieu of guard rails.
 - (4)(d) Where stanchions are fitted, every third stanchion shall be supported by a bracket or stay.
 - (4)(e) Removable or hinged stanchions shall be capable of being locked in the upright position.
 - (4)(f) A means of passage over obstructions such as pipes or other fittings of a permanent nature, shall be provided.
 - (4)(g) Generally, the width of the gangway or deck-level walkway should not exceed 1.5 m.
- (5) For tankers less than 100 m in length, the minimum width of the gangway platform or deck-level walkway fitted in accordance with paragraphs (2)(e) or (f) above, respectively, may be reduced to 0.6 m.

Regulation 26 Special conditions of assignment for type 'A' ships

Machinery casings

- (1) Machinery casings on type 'A' ships, as defined in regulation 27, shall be protected by one of the following arrangements:
- (1)(a) an enclosed poop or bridge of at least standard height; or
 - (1)(b) a deckhouse of equal height and equivalent strength.
- (2) Machinery casings may, however, be exposed if there are no openings giving direct access from the freeboard deck to the machinery space. A door complying with the requirements of regulation 12 is acceptable in the machinery casing, provided that it leads to a space or passageway which is as strongly constructed as the casing and is separated from the stairway to the engine-room by a second weathertight door of steel or other equivalent material.

Gangway and access

- (3) A fore and aft permanent gangway, constructed in accordance with the provisions of regulation 25-1(2)(e), shall be fitted on type 'A' ships at the level of the superstructure deck between the poop and the midship bridge or deckhouse where fitted. The arrangement contained in regulation 25-1(2)(a) is considered an equivalent means of access to carry out the purpose of the gangway.
- (4) Safe access from the gangway level shall be available between separate crew accommodations and also between crew accommodations and the machinery space.

Hatchways

- (5) Exposed hatchways on the freeboard and forecastle decks or on the tops of expansion trunks on type 'A' ships shall be provided with efficient watertight covers of steel or other equivalent material.

Freeing arrangements

- (6) Type 'A' ships with bulwarks shall have open rails fitted for at least half the length of the weather deck or other equivalent freeing arrangements. A freeing port area, in the lower part of the bulwarks, of 33% of the total area of the bulwarks, is an acceptable equivalent freeing arrangement. The upper edge of the sheer strake shall be kept as low as practicable.
- (7) Where superstructures are connected by trunks, open rails shall be fitted for the whole length of the exposed parts of the freeboard deck.

**Notice from the Danish Maritime Authority B –
The Construction and Equipment, etc. of Ships**

Chapter B II-5 A(I-III)

REVISED ARTICLES OF INTERNATIONAL CONVENTION ON LOAD LINES,
1966

INTERNATIONAL CONVENTION ON LOAD LINES, 1966

ANNEX I

REGULATIONS FOR DETERMINING LOAD LINES

CHAPTER III

CONDITIONS OF ASSIGNMENT OF FREEBOARD

Regulation 27 Types of ships.....	1
Regulation 28 Freeboard tables.....	7
Regulation 29 Correction to the freeboard for ships under 100 m in length	14
Regulation 30 Correction for block coefficient	15
Regulation 31 Correction for depth	15
Regulation 32 Correction for position of deck line.....	15
Regulation 32-1 Correction for recess in freeboard deck	15
Regulation 33 Standard height of superstructure.....	16
Regulation 34 Length of superstructure.....	17
Regulation 35 Effective length of superstructure	18
Regulation 36 Trunks.....	19
Regulation 37 Deduction for superstructures and trunks.....	20
Regulation 38 Sheer.....	21
Regulation 39 Minimum bow height and reserve buoyancy	25
Regulation 40 Minimum freeboards	28

Regulation 27 Types of ships

(1) For the purposes of freeboard computation, ships shall be divided into type 'A' and type 'B'.

Type 'A' ships

(2) A type 'A' ship is one which:

- (2)(a) is designed to carry only liquid cargoes in bulk;
 - (2)(b) has a high integrity of the exposed deck with only small access openings to cargo compartments, closed by watertight gasketed covers of steel or equivalent material; and
 - (2)(c) has low permeability of loaded cargo compartments.
- (3) A type 'A' ship, if over 150 m in length, to which a freeboard less than type 'B' has been assigned, when loaded in accordance with the requirements of paragraph (11), shall be able to withstand the flooding of any compartment or compartments, with an assumed permeability of 0.95, consequent upon the damage assumptions specified in paragraph (12), and shall remain afloat in a satisfactory condition of equilibrium, as specified in paragraph (13). In such a ship, the machinery space shall be treated as a floodable compartment, but with a permeability of 0.85.
- (4) A type 'A' ship shall be assigned a freeboard not less than that based on table 28.1.

Type 'B' ships

- (5) All ships which do not come within the provisions regarding type 'A' ships in paragraphs (2) and (3) shall be considered as type 'B' ships.
- (6) Type 'B' ships, which in position 1 have hatch covers which are permitted by the Administration to comply with the requirements of regulation 15 (other than paragraph (6)) or which are fitted with securing arrangements accepted under the provisions of regulation 16(6), shall be assigned freeboards based upon the values given in table 28.2, increased by the values given in table 27.1:

Table 27.1
Freeboard increase over tabular freeboard for type ‘B’ ships, for ships with hatch covers complying with the provisions of regulation 15 (other than paragraph (6))

Length of ship (m)	Freeboard increase (mm)	Length of ship (m)	Freeboard increase (mm)	Length of ship (m)	Freeboard increase (mm)
≤108	50	139	175	170	290
109	52	140	181	171	292
110	55	141	186	172	294
111	57	142	191	173	297
112	59	143	196	174	299
113	62	144	201	175	301
114	64	145	206	176	304
115	68	146	210	177	306
116	70	147	215	178	308
117	73	148	219	179	311
118	76	149	224	180	313
119	80	150	228	181	315
120	84	151	232	182	318
121	87	152	236	183	320
122	91	153	240	184	322
123	95	154	244	185	325
124	99	155	247	186	327
125	103	156	251	187	329
126	108	157	254	188	332
127	112	158	258	189	334
128	116	159	261	190	336
129	121	160	264	191	339
130	126	161	267	192	341
131	131	162	270	193	343
132	136	163	273	194	346
133	142	164	275	195	348
134	147	165	278	196	350
135	153	166	280	197	353
136	159	167	283	198	355
137	164	168	285	199	357
138	170	169	287	200	358

Freeboards at intermediate lengths of ship shall be obtained by linear interpolation. Ships above 200 m in length shall be dealt with by the Administration.

- (7) Type 'B' ships, which in position 1 have hatchways fitted with hatch covers complying with the requirements of regulation 16(2) through (5), shall, except as provided in paragraphs (8) to (13) inclusive, be assigned freeboards based on table 28.2.
- (8) Any type 'B' ship of over 100 m in length may be assigned freeboards less than those required under paragraph (7), provided that, in relation to the amount of reduction granted, the Administration is satisfied that:
 - (8)(a) the measures provided for the protection of the crew are adequate;
 - (8)(b) the freeing arrangements are adequate;
 - (8)(c) the covers in position 1 and 2 comply with the provisions of regulation 16(1) through (5) and (7); and

- (8)(d) the ship, when loaded in accordance with the requirements of paragraph (11), shall be able to withstand the flooding of any compartment or compartments, with an assumed permeability of 0.95, consequent upon the damage assumptions specified in paragraph (12), and shall remain afloat in a satisfactory condition of equilibrium, as specified in paragraph (13). In such a ship, if over 150 m in length, the machinery space shall be treated as a floodable compartment, but with a permeability of 0.85.
- (9) In calculating the freeboards for type 'B' ships which comply with the requirements of paragraphs (8), (11), (12) and (13), the values from table 28.2 shall not be reduced by more than 60% of the difference between the tabular values in tables 28.1 and 28.2 for the appropriate ship lengths.
- (10)
 - (10)(a) The reduction in tabular freeboard allowed under paragraph (9) may be increased up to the total difference between the values in table 28.1 and those in table 28.2 on condition that the ship complies with the requirements of:
 - (10)(a)(i) regulation 26, other than paragraph (5), as if it were a type 'A' ship;
 - (10)(a)(ii) paragraphs (8), (11) and (13); and
 - (10)(a)(iii) paragraph (12), provided that throughout the length of the ship any one transverse bulkhead will be assumed to be damaged, such that two adjacent fore and aft compartments shall be flooded simultaneously, except that such damage will not apply to the boundary bulkheads of a machinery space.
 - (10)(b) In such a ship, if over 150 m in length, the machinery space shall be treated as a floodable compartment, but with a permeability of 0.85.

Initial condition of loading

- (11) The initial condition of loading before flooding shall be determined as follows:
 - (11)(a) The ship is loaded to its summer load waterline on an imaginary even keel.
 - (11)(b) When calculating the vertical centre of gravity, the following principles apply:
 - (11)(b)(i) homogeneous cargo is carried;
 - (11)(b)(ii) all cargo compartments, except those referred to under subparagraph (iii), but including compartments intended to be partially filled, shall be considered fully loaded except that in the case of fluid cargoes each compartment shall be treated as 98% full;
 - (11)(b)(iii) if the ship is intended to operate at its summer load waterline with empty compartments, such compartments shall be considered empty, provided the height of the centre of gravity so calculated is not less than as calculated under subparagraph (ii);
 - (11)(b)(iv) 50% of the individual total capacity of all tanks and spaces fitted to contain consumable liquids and stores is allowed for. It shall be assumed that for each type of liquid at least one transverse pair or a single centreline tank has maximum free surface, and the tank or combination of tanks to be taken into account shall be those where the effect of free surfaces is the greatest; in each tank the centre of gravity of the contents shall be taken at the centre of volume of the tank. The remaining tanks shall be assumed either completely empty or completely filled, and the distribution of consumable liquids between these tanks shall be effected so as to obtain the greatest possible height above the keel for the centre of gravity;

- (11)(b)(v) at an angle of heel of not more than 5° in each compartment containing liquids, as prescribed in subparagraph (ii), except that in the case of compartments containing consumable fluids, as prescribed in subparagraph (iv), the maximum free surface effect shall be taken into account. Alternatively, the actual free surface effects may be used, provided the methods of calculation are acceptable to the Administration;
- (11)(b)(vi) weights shall be calculated on the basis of the following values for specific gravities:

salt water	1.025
fresh water	1.000
oil fuel	0.950
diesel oil	0.900
lubricating oil	0.900.

Damage assumptions

- (12) The following principles regarding the character of the assumed damage apply:
- (12)(a) The vertical extent of damage in all cases is assumed to be from the base line upwards without limit.
- (12)(b) The transverse extent of damage is equal to B/5 or 11.5 m, whichever is the lesser, measured inboard from the side of the ship perpendicularly to the centreline at the level of the summer load waterline.
- (12)(c) If damage of a lesser extent than specified in subparagraphs (a) and (b) results in a more severe condition, such lesser extent shall be assumed.
- (12)(d) Except where otherwise required by paragraph (10)(a), the flooding shall be confined to a single compartment between adjacent transverse bulkheads, provided that the inner longitudinal boundary of the compartment is not in a position within the transverse extent of assumed damage. Transverse boundary bulkheads of wing tanks, which do not extend over the full breadth of the ship shall be assumed not to be damaged, provided that they extend beyond the transverse extent of assumed damage prescribed in subparagraph (b). If in a transverse bulkhead there are steps or recesses of not more than 3 m in length, located within the transverse extent of assumed damage as defined in subparagraph (b), such transverse bulkhead may be considered intact and the adjacent compartment may be floodable singly. If, however, within the transverse extent of assumed damage there is a step or recess of more than 3 m in length in a transverse bulkhead, the two compartments adjacent to this bulkhead shall be considered as flooded. The step formed by the afterpeak bulkhead and the afterpeak tank top shall not be regarded as a step for the purpose of this regulation.
- (12)(e) Where a main transverse bulkhead is located within the transverse extent of assumed damage and is stepped in way of a double bottom or side tank by more than 3 m, the double bottom or side tanks adjacent to the stepped portion of the main transverse bulkhead shall be considered as flooded simultaneously. If this side tank has openings into one or several holds, such as grain feeding holes, such hold or holds shall be considered as flooded simultaneously. Similarly, in a ship designed for the carriage of fluid cargoes, if a side tank has openings into adjacent compartments, such adjacent compartments shall be considered as empty and as being flooded simultaneously. This provision is applicable even where such openings are fitted with closing appliances, except in the case of sluice valves fitted in bulkheads

between tanks and where the valves are controlled from the deck. Manhole covers with closely spaced bolts are considered equivalent to the unpierced bulkhead, except in the case of openings in topside tanks making the topside tanks common to the holds.

- (12)(f) Where the flooding of any two adjacent fore and aft compartments is envisaged, main transverse watertight bulkheads shall be spaced at least $1/3L$ $2/3$ or 14.5 m, whichever is the lesser, in order to be considered effective. Where transverse bulkheads are spaced at a lesser distance, one or more of these bulkheads shall be assumed as non-existent in order to achieve the minimum spacing between bulkheads.

Condition of equilibrium

(13) The condition of equilibrium after flooding shall be regarded as satisfactory provided:

- (13)(a) The final waterline after flooding, taking into account sinkage, heel and trim, is below the lower edge of any opening through which progressive downflooding may take place. Such openings shall include air pipes, ventilators (even if they comply with regulation 19(4)) and openings which are closed by means of weathertight doors (even if they comply with regulation 12) or hatch covers (even if they comply with regulation 16(1) through (5)), and may exclude those openings closed by means of manhole covers and flush scuttles (which comply with regulation 18), cargo hatch covers of the type described in regulation 27(2), remotely operated sliding watertight doors, and sidescuttles of the non-opening type (which comply with regulation 23). However, in the case of doors separating a main machinery space from a steering gear compartment, watertight doors may be of a hinged, quick-acting type kept closed at sea whilst not in use, provided also that the lower sill of such doors is above the summer load waterline.
- (13)(b) If pipes, ducts or tunnels are situated within the assumed extent of damage penetration as defined in paragraph (12)(b), arrangements shall be made so that progressive flooding cannot thereby extend to compartments other than those assumed to be floodable in the calculation for each case of damage.
- (13)(c) The angle of heel due to unsymmetrical flooding does not exceed 15° . If no part of the deck is immersed, an angle of heel of up to 17° may be accepted.
- (13)(d) The metacentric height in the flooded condition is positive.
- (13)(e) When any part of the deck outside the compartment assumed flooded in a particular case of damage is immersed, or in any case where the margin of stability in the flooded condition may be considered doubtful, the residual stability is to be investigated. It may be regarded as sufficient if the righting lever curve has a minimum range of 20° beyond the position of equilibrium with a maximum righting lever of at least 0.1 m within this range. The area under the righting lever curve within this range shall be not less than 0.0175 m.rad. The Administration shall give consideration to the potential hazard presented by protected or unprotected openings which may become temporarily immersed within the range of residual stability.
- (13)(f) The Administration is satisfied that the stability is sufficient during intermediate stages of flooding.

Ships without means of propulsion

- (14) A lighter, barge or other ship without independent means of propulsion shall be assigned a freeboard in accordance with the provisions of these regulations. Barges which meet the requirements of paragraphs (2) and (3) may be assigned type 'A' freeboards:
- (14)(a) The Administration should especially consider the stability of barges with cargo on the weather deck. Deck cargo can only be carried on barges to which the ordinary type 'B' freeboard is assigned.
- (14)(b) However, in the case of barges which are unmanned, the requirements of regulations 25, 26(3), 26(4) and 39 shall not apply.
- (14)(c) Such unmanned barges which have on the freeboard deck only small access openings closed by watertight gasketed covers of steel or equivalent material may be assigned a freeboard 25% less than those calculated in accordance with these regulations.

Regulation 28 Freeboard tables

Type 'A' ships

- (1) The tabular freeboard for type 'A' ships shall be determined from table 28.1:

Table 28.1
Freeboard table for type 'A' ships

Length of ship (m)	Freeboard (mm)	Length of ship (m)	Freeboard (mm)
24	200	52	467
25	208	53	478
26	217	54	490
27	225	55	503
28	233	56	516
29	242	57	530
30	250	58	544
31	258	59	559
32	267	60	573
33	275	61	587
34	283	62	600
35	292	63	613
36	300	64	626
37	308	65	639
38	316	66	653
39	325	67	666
40	334	68	680
41	344	69	693
42	354	70	706
43	364	71	720
44	374	72	733
45	385	73	746
46	396	74	760
47	408	75	773
48	420	76	786
49	432	77	800
50	443	78	814

Length of ship (m)	Freeboard (mm)	Length of ship (m)	Freeboard (mm)
51	455	79	828
80	841	118	1426
81	855	119	1442
82	869	120	1459
83	883	121	1476
84	897	122	1494
85	911	123	1511
86	926	124	1528
87	940	125	1546
88	955	126	1563
89	969	127	1580
90	984	128	1598
91	999	129	1615
92	1014	130	1632
93	1029	131	1650
94	1044	132	1667
95	1059	133	1684
96	1074	134	1702
97	1089	135	1719
98	1105	136	1736
99	1120	137	1753
100	1135	138	1770
101	1151	139	1787
102	1166	140	1803
103	1181	141	1820
104	1196	142	1837
105	1212	143	1853
106	1228	144	1870
107	1244	145	1886
108	1260	146	1903
109	1276	147	1919
110	1293	148	1935
111	1309	149	1952
112	1326	150	1968
113	1342	151	1984
114	1359	152	2000
115	1376	153	2016
116	1392	154	2032
117	1409	155	2048
156	2064	194	2552
157	2080	195	2562
158	2096	196	2572
159	2111	197	2582
160	2126	198	2592
161	2141	199	2602
162	2155	200	2612
163	2169	201	2622
164	2184	202	2632
165	2198	203	2641

Length of ship (m)	Freeboard (mm)	Length of ship (m)	Freeboard (mm)
166	2212	204	2650
167	2226	205	2659
168	2240	206	2669
169	2254	207	2678
170	2268	208	2687
171	2281	209	2696
172	2294	210	2705
173	2307	211	2714
174	2320	212	2723
175	2332	213	2732
176	2345	214	2741
177	2357	215	2749
178	2369	216	2768
179	2381	217	2767
180	2393	218	2775
181	2405	219	2784
182	2416	220	2792
183	2428	221	2801
184	2440	222	2809
185	2451	223	2817
186	2463	224	2825
187	2474	225	2833
188	2486	226	2841
189	2497	227	2849
190	2508	228	2857
191	2519	229	2865
192	2530	230	2872
193	2541	231	2880
232	2888	270	3128
233	2895	271	3133
234	2903	272	3138
235	2910	273	3143
236	2918	274	3148
237	2925	275	3153
238	2932	276	3158
239	2939	277	3163
240	2946	278	3167
241	2953	279	3172
242	2959	280	3176
243	2966	281	3181
244	2973	282	3185
245	2979	283	3189
246	2986	284	3194
247	2993	285	3198
248	3000	286	3202
249	3006	287	3207
250	3012	288	3211
251	3018	289	3215
252	3024	290	3220

Length of ship (m)	Freeboard (mm)	Length of ship (m)	Freeboard (mm)
253	3030	291	3224
254	3036	292	3228
255	3042	293	3233
256	3048	294	3237
257	3054	295	3241
258	3060	296	3246
259	3066	297	3250
260	3072	298	3254
261	3078	299	3258
262	3084	300	3262
263	3089	301	3266
264	3095	302	3270
265	3101	303	3274
266	3106	304	3278
267	3112	305	3281
268	3117	306	3285
269	3123	307	3288
308	3292	337	3375
309	3295	338	3378
310	3298	339	3380
311	3302	340	3382
312	3305	341	3385
313	3308	342	3387
314	3312	343	3389
315	3315	344	3392
316	3318	345	3394
317	3322	346	3396
318	3325	347	3399
319	3328	348	3401
320	3331	349	3403
321	3334	350	3406
322	3337	351	3408
323	3339	352	3410
324	3342	353	3412
325	3345	354	3414
326	3347	355	3416
327	3350	356	3418
328	3353	357	3420
329	3355	358	3422
330	3358	359	3423
331	3361	360	3425
332	3363	361	3427
333	3366	362	3428
334	3368	363	3430
335	3371	364	3432
336	3373	365	3433

Freeboards at intermediate lengths of ship shall be obtained by linear interpolation.
Ships above 365 m in length shall be dealt with by the Administration.

Type 'B' ships

(2) The tabular freeboard for type 'B' ships shall be determined from table 28.2:

Table 28.2
Freeboard table for type 'B' ships

Length of ship (m)	Freeboard (mm)	Length of ship (m)	Freeboard (mm)
24	200	54	490
25	208	55	503
26	217	56	516
27	225	57	530
28	233	58	544
29	242	59	559
30	250	60	573
31	258	61	587
32	267	62	601
33	275	63	615
34	283	64	629
35	292	65	644
36	300	66	659
37	308	67	674
38	316	68	689
39	325	69	705
40	334	70	721
41	344	71	738
42	354	72	754
43	364	73	769
44	374	74	784
45	385	75	800
46	396	76	816
47	408	77	833
48	420	78	850
49	432	79	868
50	443	80	887
51	455	81	905
52	467	82	923
53	478	83	942
84	960	122	1729
85	978	123	1750
86	996	124	1771
87	1015	125	1793
88	1034	126	1815
89	1054	127	1837
90	1075	128	1859
91	1096	129	1880
92	1116	130	1901
93	1135	131	1921
94	1154	132	1940
95	1172	133	1959
96	1190	134	1979

Length of ship (m)	Freeboard (mm)	Length of ship (m)	Freeboard (mm)
97	1209	135	2000
98	1229	136	2021
99	1250	137	2043
100	1271	138	2065
101	1293	139	2087
102	1315	140	2109
103	1337	141	2130
104	1359	142	2151
105	1380	143	2171
106	1401	144	2190
107	1421	145	2209
108	1440	146	2229
109	1459	147	2250
110	1479	148	2271
111	1500	149	2293
112	1521	150	2315
113	1543	151	2334
114	1565	152	2354
115	1587	153	2375
116	1609	154	2396
117	1630	155	2418
118	1651	156	2440
119	1671	157	2460
120	1690	158	2480
121	1709	159	2500
160	2520	198	3235
161	2540	199	3249
162	2560	200	3264
163	2580	201	3280
164	2600	202	3296
165	2620	203	3313
166	2640	204	3330
167	2660	205	3347
168	2680	206	3363
169	2698	207	3380
170	2716	208	3397
171	2735	209	3413
172	2754	210	3430
173	2774	211	3445
174	2795	212	3460
175	2815	213	3475
176	2835	214	3490
177	2855	215	3505
178	2875	216	3520
179	2895	217	3537
180	2915	218	3554
181	2933	219	3570
182	2952	220	3586
183	2970	221	3601

Length of ship (m)	Freeboard (mm)	Length of ship (m)	Freeboard (mm)
184	2988	222	3615
185	3007	223	3630
186	3025	224	3645
187	3044	225	3660
188	3062	226	3675
189	3080	227	3690
190	3098	228	3705
191	3116	229	3720
192	3134	230	3735
193	3151	231	3750
194	4167	232	3765
195	3185	233	3780
196	3202	234	3795
197	3219	235	3808
236	3821	274	4327
237	3835	275	4339
238	3849	276	4350
239	3864	277	4362
240	3880	278	4373
241	3893	279	4385
242	3906	280	4397
243	3920	281	4408
244	3934	282	4420
245	3949	283	4432
246	3965	284	4443
247	3978	285	4455
248	3992	286	4467
249	4005	287	4478
250	4018	288	4490
251	4032	289	4502
252	4045	290	4513
253	4058	291	4525
254	4072	292	4537
255	4085	293	4548
256	4098	294	4560
257	4112	295	4572
258	4125	296	4583
259	4139	297	4594
260	4152	298	4607
261	4165	299	4618
262	4177	300	4630
263	4189	301	4642
264	4201	302	4654
265	4214	303	4665
266	4227	304	4676
267	4240	305	4686
268	4252	306	4695
269	4264	307	4704
270	4276	308	4714

Length of ship (m)	Freeboard (mm)	Length of ship (m)	Freeboard (mm)
271	4289	309	4725
272	4302	310	4736
273	4315	311	4748
312	4757	339	5045
313	4768	340	5055
314	4779	341	5065
315	4790	342	5075
316	4801	343	5086
317	4812	344	5097
318	4823	345	5108
319	4834	346	5119
320	4844	347	5130
321	4855	348	5140
322	4866	349	5150
323	4878	350	5160
324	4890	351	5170
325	4899	352	5180
326	4909	353	5190
327	4920	354	5200
328	4931	355	5210
329	3943	356	5220
330	4955	357	5230
331	4965	358	5240
332	4975	359	5250
333	4985	360	5260
334	4995	361	5268
335	5005	362	5276
336	5015	363	5285
337	5025	364	5294
338	5035	365	5303

Freeboard at intermediate lengths of ship shall be obtained by linear interpolation. Ships above 365 m in length shall be dealt with by the Administration.

Regulation 29 Correction to the freeboard for ships under 100 m in length

The tabular freeboard for a type 'B' ship of between 24 m and 100 m in length having enclosed superstructures with an effective length of up to 35% of the length of the ship shall be increased by:

$$7,5 (100 - L) \left(0,35 - \frac{E_1}{L} \right) (\text{mm})$$

where L is the length of the ship in m; and

E₁ is the effective length E of superstructure

Regulation 30 Correction for block coefficient

Where the block coefficient (C_b) exceeds 0.68, the tabular freeboard specified in regulation 28 as modified, if applicable, by regulations 27(8), 27(10) and 29 shall be multiplied by the factor:

$$\frac{C_b + 0,68}{1,36}$$

The block coefficient is not to be taken greater than 1.0.

Regulation 31 Correction for depth

- (1) Where D exceeds $\frac{L}{15}$,
the freeboard shall be increased by

$$\left(D - \frac{L}{15}\right) R \text{ mm, where } R \text{ is } \frac{L}{0,48} \text{ at lengths}$$

less than 120 m and 250 at 120 m length and above.

- (2) Where D is less than $\frac{L}{15}$, no reduction shall be made, except in a ship with an enclosed superstructure covering at least $0.6L$ amidships, with a complete trunk, or combination of detached enclosed superstructures and trunks which extend all fore and aft, where the freeboard shall be reduced at the rate prescribed in paragraph (1).
- (3) Where the height of the superstructure or trunk is less than the corresponding standard height, the calculated reduction shall be corrected in the ratio of the height of the actual superstructure or trunk to the applicable standard height, as defined in regulation 33.

Regulation 32 Correction for position of deck line

Where the actual depth to the upper edge of the deck line is greater or less than D , the difference between the depths shall be added to or deducted from the freeboard.

Regulation 32-1 Correction for recess in freeboard deck

- (1) Where a recess is arranged in the freeboard deck, and it does not extend to the sides of the ship, the freeboard calculated without regard to the recess shall be corrected for the consequent loss of buoyancy. The correction shall be equal to the value obtained by dividing the volume of the recess by the waterplane area of the ship at 85% of the least moulded depth (see figure 32-1.1).
- (2) The correction shall be an addition to the freeboard obtained after all other corrections have been applied, except bow height correction.
- (3) Where the freeboard, corrected for lost buoyancy as above, is greater than the minimum geometric freeboard determined on the basis of a moulded depth measured to the bottom of the recess, the latter value may be used.

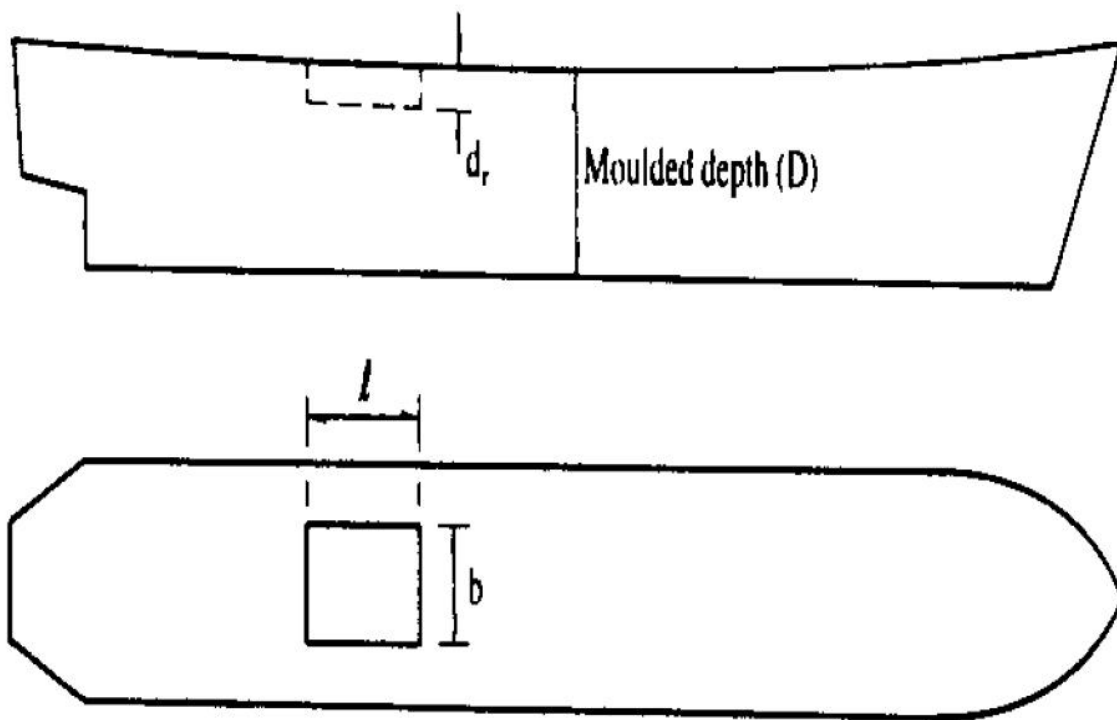

Figure 32-1.1

Correction is the addition to freeboard equal to:

$$\frac{l \times b \times d_r}{WP \text{ areal ved } 0,85D}$$

Regulation 33 Standard height of superstructure

The standard height of a superstructure shall be as given in the following table:

Table 33.1

L (m)	Standard height (in m)	
	Raised quarterdeck	All other superstructures
30 or less	0.9	1.8
75	1.2	1.8
125 or more	1.8	2.3

The standard heights at intermediate lengths of the ship shall be obtained by linear interpolation.

Regulation 34 Length of superstructure

- (1) Except as provided in paragraph (2), the length of a superstructure (S) shall be the mean length of the parts of the superstructure which lie within the length (L).

Where a superstructure bulkhead is recessed, the effective length of the superstructure shall be reduced by an amount equal to the area of the recess in plan view divided by the breadth of the superstructure at the midlength of the recess. Where the recess is unsymmetrical about the centreline, the largest portion of the recess shall be considered as applying to both sides of the ship. A recess need not be decked over.

- (2) Where the end bulkhead of an enclosed superstructure extends in a fair convex curve beyond its intersection with the superstructure sides, the length of the superstructure may be increased on the basis of an equivalent plane bulkhead. This increase shall be two-thirds of the fore and aft extent of the curvature. The maximum curvature which may be taken into account in determining this increase is one-half the breadth of the superstructure at the point of intersection of the curved end of the superstructure with its side.

Where there is an extension to a superstructure, which extension has a breadth on each side of the centre line at least 30% of the breadth of the ship, the effective length of the superstructure may be increased by considering an equivalent superstructure bulkhead in the form of a parabola. This parabola shall extend from the extension at the centreline and pass through the junction of the actual superstructure bulkhead with the sides of the extension and extend to the sides of the ship. This parabola shall be completely contained within the boundary of the superstructure and its extensions.

If the superstructure is set-in from the side, up to the limit allowed under regulation 3(10), the equivalent bulkhead should be calculated on the basis of the actual breadth of the superstructure (and not the breadth of the ship).

- (3) Superstructures which have sloped end bulkheads shall be dealt with in the following manner:
 - (3)(a) When the height of superstructure, clear of the slope, is equal to or smaller than the standard height, length S is to be obtained as shown in figure 34.1.
 - (3)(b) When the height is greater than the standard, length S is to be obtained as shown in figure 34.2.
 - (3)(c) The foregoing will apply only when the slope, related to the base line, is 15° or greater. Where the slope is less than 15°, the configuration shall be treated as sheer.

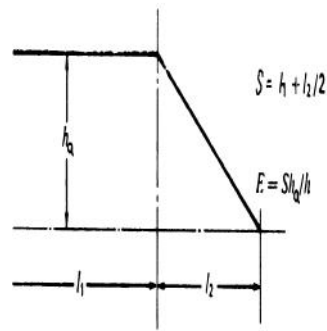

Figure 34.1 Height of superstructure equal to or smaller than the standard height h

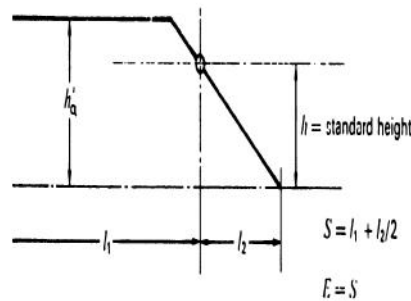

Figure 34.2 Height of superstructure greater than the standard height

Regulation 35 Effective length of superstructure

- (1) Except as provided for in paragraph (2), the effective length (E) of an enclosed superstructure of standard height shall be its length.
- (2) In all cases where an enclosed superstructure of standard height is set-in from the sides of the ship as permitted in regulation 3(10), the effective length shall be the length modified by the ratio of b/B_s , where:

b is the breadth of the superstructure at the middle of its length; and

B_s is the breadth of the ship at the middle of the length of the superstructure.

- (3) Where a superstructure is set-in for a part of its length, this modification shall be applied only to the set-in part.

Where the height of an enclosed superstructure is less than the standard height, the effective length shall be its length reduced in the ratio of the actual height to the standard height. Where the height exceeds the standard, no increase shall be made to the effective length of the superstructure (see figures 34.1 and 34.2).

Where the height, clear of the slope, of a superstructure which has sloped end bulkheads is less than the standard height, its effective length E shall be its length S as obtained from figure 34.1, reduced in the ratio of the actual height to the standard height.

- (4) Where a poop or forecastle of less than standard height is fitted on a ship with excessive sheer but without any superstructure within $0.2L$ amidships, credit may be given to the height of the poop or forecastle by increasing the actual height by the difference between the actual and the standard sheer profiles. The deduction for excess sheer in accordance with regulation 38(16) is not to be granted.

The effective length of a raised quarter deck, if fitted with an intact front bulkhead, shall be its length up to a maximum of $0.6L$. Where the bulkhead is not intact, the raised quarter deck shall be treated as a poop of less than standard height.

- (5) The maximum effective length of $0.6L$ of a raised quarterdeck is to be measured from the after perpendicular, even where a poop is fitted in conjunction with the raised quarterdeck.
- (6) Superstructures which are not enclosed shall have no effective length.

Regulation 36 Trunks

- (1) A trunk or similar structure which does not extend to the sides of the ship shall be regarded as efficient on the following conditions:
 - (1)(a) the trunk is at least as strong as a superstructure;
 - (1)(b) the hatchways are in the trunk deck, the hatchway coamings and covers comply with the requirements of regulations 13 to 16 inclusive and the width of the trunk deck stringer provides a satisfactory gangway and sufficient lateral stiffness. However, small access openings with watertight covers may be permitted in the freeboard deck;
 - (1)(c) a permanent working platform fore and aft fitted with guard rails is provided by the trunk deck, or by detached trunks connected to superstructures by efficient permanent gangways;
 - (1)(d) ventilators are protected by the trunk, by watertight covers or by other equivalent means;
 - (1)(e) open rails are fitted on the weather parts of the freeboard deck in way of the trunk for at least half their length or, alternatively, freeing port area in the lower part of the bulwarks, subject to regulation 24(2), of 33% of the total area of the bulwarks is provided;
 - (1)(f) the machinery casings are protected by the trunk, by a superstructure of at least standard height, or by a deckhouse of the same height and of equivalent strength;
 - (1)(g) the breadth of the trunk is at least 60% of the breadth of the ship; and
 - (1)(h) where there is no superstructure, the length of the trunk is at least $0.6L$.
- (2) The full length of an efficient trunk reduced in the ratio of its mean breadth to B shall be its effective length.
- (3) The standard height of a trunk is the standard height of a superstructure other than a raised quarter deck.
- (4) Where the height of a trunk is less than the standard height, its effective length shall be reduced in the ratio of the actual to the standard height. Where the height of hatchway coamings on the trunk deck is less than that required under regulation 14-1, a reduction from

the actual height of trunk shall be made which corresponds to the difference between the actual and the required height of coaming.

- (5) Where the trunk height is less than standard and the trunk hatch coamings are also of less than standard height, or omitted entirely, the reduction from the actual height of trunk on account of insufficient hatch coaming height shall be taken as the difference between 600 mm and the actual height of coaming, or 600 mm if no hatch coamings are fitted. Reduction in the actual height of trunk shall not be required in cases where only small hatches with less than standard height are fitted in the trunk deck for which dispensation from the requirement of standard coaming height may be given.
- (6) Continuous hatchways may be treated as a trunk in the freeboard computation, provided the provisions of this paragraph are complied with in all respects.

The trunk deck stringer referred to in paragraph (1)(b) may be fitted outboard of the trunk side bulkhead in association with the following:

- (6)(a) the stringer so formed is to provide a clear walkway of at least 450 mm in width on each side of the ship;
- (6)(b) the stringer is to be of solid plate, efficiently supported and stiffened;
- (6)(c) the stringer is to be as high above the freeboard deck as practicable. In the freeboard calculation, the trunk height is to be reduced by at least 600 mm or by the actual difference between the top of the trunk and the stringer, whichever is greater;
- (6)(d) hatch cover securing appliances are to be accessible from the stringer or walkway; and
- (6)(e) the breadth of the trunk is to be measured between the trunk side bulkheads.
- (7) Where the trunk adjoining the superstructures such as poop, bridge or forecastle is included in the calculation of freeboard, openings shall not be arranged in that part of the bulkhead which is common for the trunk and superstructure. A relaxation may be made for small openings such as for piping, cable or manholes with covers attached by means of bolts.
- (8) The sides of a trunk included in the calculation of freeboard shall be intact. Side scuttles of the non-opening type and bolted manhole covers may be allowed.

Regulation 37 Deduction for superstructures and trunks

- (1) Where the effective length of superstructures and trunks is 1L, the deduction from the freeboard shall be 350 mm at 24 m length of ship, 860 mm at 85 m length and 1,070 mm at 122 m length and above. Deductions at intermediate lengths shall be obtained by linear interpolation.
- (2) Where the total effective length of superstructures and trunks is less than 1L, the deduction shall be a percentage obtained from the following table:

**Table 37.1
Percentage of deduction for type 'A' and 'B' ships**

	Total Effective Length Superstructures and Trunks										
	0	0.1 L	0.2 L	0.3 L	0.4 L	0.5 L	0.6 L	0.7 L	0.8 L	0.9 L	1.0 L
Percentage of deduction for all types of superstructures	0	7	14	21	31	41	52	63	75.3	87.7	100

Percentages at intermediate lengths of superstructures and trunks shall be obtained by linear interpolation.

- (3) For ships of type 'B' where the effective length of a forecastle is less than $0.07L$ no deduction is allowed.

Regulation 38 Sheer

General

- (1) The sheer shall be measured from the deck at side to a line of reference drawn parallel to the keel through the sheer line amidships.
- (2) In ships designed with a rake of keel, the sheer shall be measured in relation to a reference line drawn parallel to the design load waterline.
- (3) In flush deck ships and in ships with detached superstructures the sheer shall be measured at the freeboard deck.
- (4) In ships with topsides of unusual form in which there is a step or break in the topsides, the sheer shall be considered in relation to the equivalent depth amidships.
- (5) In ships with a superstructure of standard height which extends over the whole length of the freeboard deck, the sheer shall be measured at the superstructure deck. Where the height exceeds the standard, the least difference (Z) between the actual and standard heights shall be added to each end ordinate. Similarly, the intermediate ordinates at distances of $1/6L$ and $1/3L$ from each perpendicular shall be increased by $0.444Z$ and $0.111Z$, respectively. Where there is an enclosed poop or forecastle superimposed on the superstructure, sheer credit shall be allowed for such a poop or forecastle, according to the method of paragraph (12) as shown in figure 38.1.

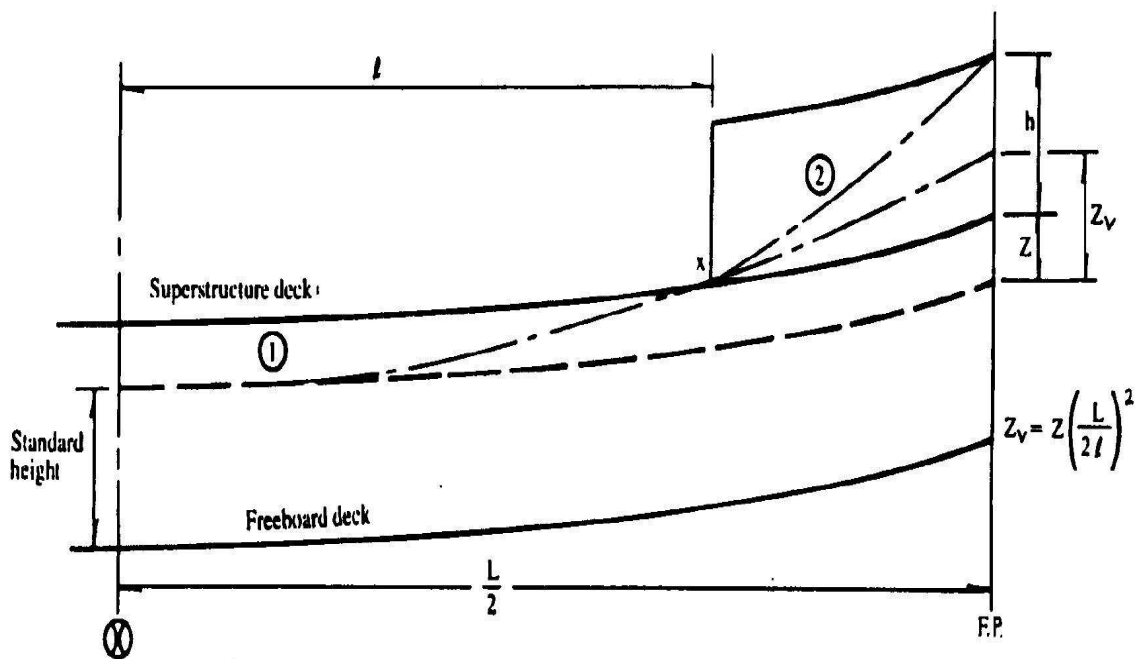

Figure 38.1

- (6) Where the deck of an enclosed superstructure has at least the same sheer as the exposed freeboard deck, the sheer of the enclosed portion of the freeboard deck shall not be taken into account.
- (7) Where an enclosed poop or forecastle is of standard height with greater sheer than that of the freeboard deck, or is of more than standard height, an addition to the sheer of the freeboard deck shall be made as provided in paragraph (12).

Where a poop or forecastle consists of two layers, the method shown in figure 38.2 shall be used.

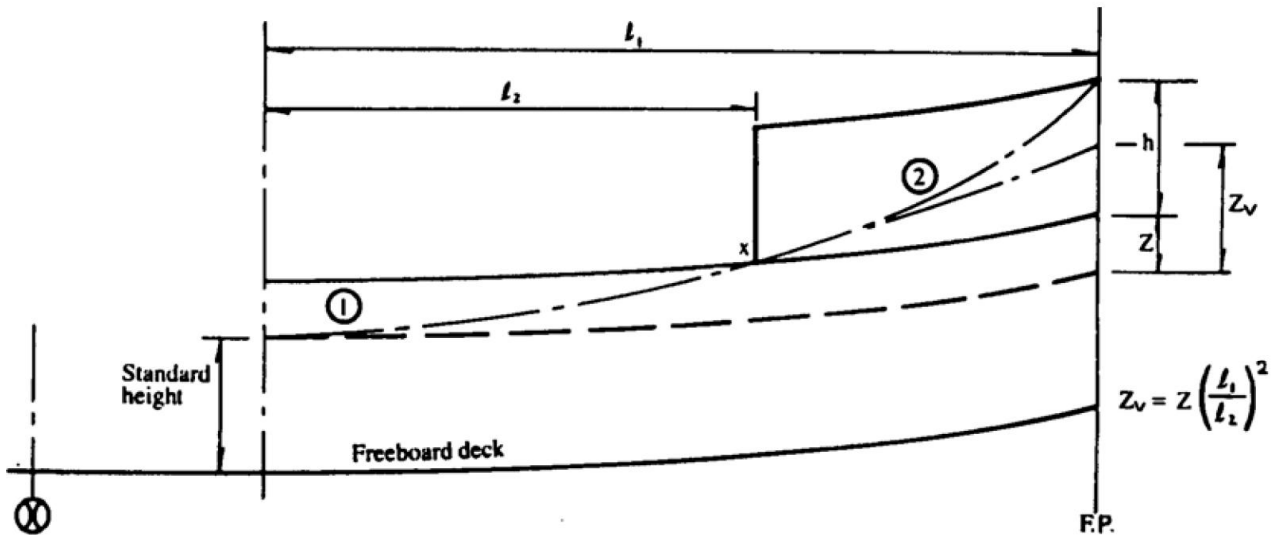

Figure 38.2

In figures 38.1 and 38.2, the following definitions apply:

Z is as defined in paragraph (5); and

Z_v is the end ordinate of a virtual standard parabolic curve taken through the point "X". If Z_v is greater than $(Z + h)$, the end ordinate shall be $(Z + h)$, in which case point "X" shall be disregarded and curve (2) not taken into account.

When the length of the first tier superstructure is greater than 0.5l, the virtual standard parabolic curve shall commence at amidships as indicated in figure 38.1.

Standard sheer profile

- (8) The ordinates of the standard sheer profile are given in the following table:

Table 38.1
Standard shear profile
(where L is in m)

	Station	Ordinate (in mm)	Factor
After half	After Perpendicular	$25(\frac{L}{3} + 10)$	1
	1/6L from A.P.	$11.1(\frac{L}{3} + 10)$	3
	1/3L from A.P.	$2.8(\frac{L}{3} + 10)$	3
	Amidships	0	1
	Amidships	0	1
Forward half	1/3L from F.P.	$5.6(\frac{L}{3} + 10)$	3
	1/6L from F.P.	$22.2(\frac{L}{3} + 10)$	3
	Forward Perpendicular	$50(\frac{L}{3} + 10)$	1

Measurement of variation from standard shear profile

- (9) Where the shear profile differs from the standard, the four ordinates of each profile in the forward or after half shall be multiplied by the appropriate factors given in the above table of ordinates. The difference between the sums of the respective products and those of the standard divided by 8 measures the deficiency or excess of shear in the forward or after half. The arithmetical mean of the excess or deficiency in the forward and after halves measures the excess or deficiency of shear.
- (10) Where the after half of the shear profile is greater than the standard and the forward half is less than the standard, no credit shall be allowed for the part in excess and deficiency only shall be measured.
- (11) Where the forward half of the shear profile exceeds the standard, and the after portion of the shear profile is not less than 75% of the standard, credit shall be allowed for the part in excess. Where the after part is less than 50% of the standard no credit shall be given for the excess shear forward. Where the after shear is between 50% and 75% of the standard, intermediate allowances may be granted for excess shear forward.
- (12) Where shear credit is given for a poop or forecastle the following formula shall be used:

$$s = \frac{y}{3} \frac{L'}{L}$$

where:

s is the shear credit, to be deducted from the deficiency, or added to the excess of shear;

y is the difference between actual and standard height of superstructure at the after or forward perpendicular;

L' is the mean enclosed length of poop or forecastle up to a maximum length of 0.5 L; and

L is the length of the ship as defined in regulation 3(1).

The above formula provides a curve in the form of a parabola tangent to the actual shear curve at the freeboard deck and intersecting the end ordinate at a point below the superstructure deck a distance equal to the standard height of a superstructure. The superstructure deck shall not be less than standard height above this curve at any point. This curve shall be used in determining the sheer profile for forward and after halves of the ship.

(13)

(13)(a) Any excess in the height of a superstructure which does not extend to the after perpendicular cannot be regarded as contributing to the sheer allowance.

(13)(b) Where the height of a superstructure is less than standard, the superstructure deck shall not be less than the minimum height of the superstructure above the virtual sheer curve at any point. For this purpose y shall be taken as the difference between the actual and minimum height of the superstructure at the after/forward perpendicular.

(13)(c) For a raised quarterdeck credit may be given only when the height of this quarterdeck is greater than the standard height of 'other superstructures' as defined in regulation 33, and only for the amount by which the actual height of the raised quarterdeck exceeds that standard height.

(13)(d) When a poop or a forecastle has sloping end bulkheads, the sheer credit may be allowed on account of excess height. The formula given in paragraph (12) shall be used, the values for y and L' being as shown in figure 38.3.

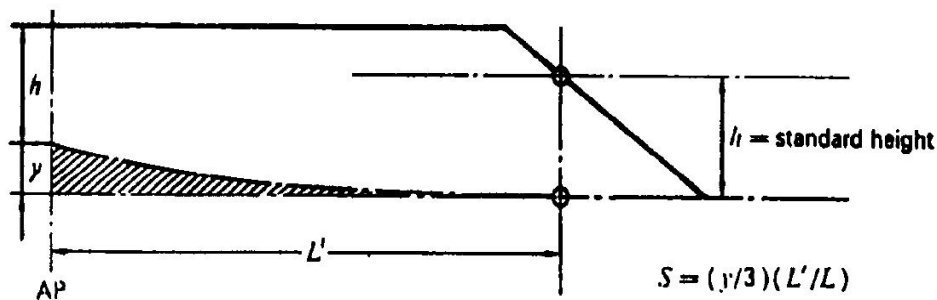

Figure 38.3 Sheer credit S for excess height

Correction for variations from standard sheer profile

- (14) The correction for sheer shall be the deficiency or excess of sheer (see paragraphs (9) to (11) inclusive), multiplied by

$$0,75 - \frac{S_1}{2L}$$

where S_1 is the total length S of enclosed superstructures as defined in regulation 34 without trunks.

Addition for deficiency in sheer

- (15) Where the sheer is less than the standard, the correction for deficiency in sheer (see paragraph (14)) shall be added to the freeboard.

Deduction for excess sheer

- (16) In ships where an enclosed superstructure covers 0.1L before and 0.1L abaft amidships, the correction for excess of sheer as calculated under the provisions of paragraph (14) shall be deducted from the freeboard; in ships where no enclosed superstructure covers amidships, no deduction shall be made from the freeboard; where an enclosed superstructure covers less than 0.1L before and 0.1L abaft amidships, the deduction shall be obtained by linear interpolation. The maximum deduction for excess sheer shall be at the rate of 125 mm per 100 m of length.

In applying this paragraph, the height of the superstructure shall be related to its standard height. Where the height of the superstructure or raised quarterdeck is less than standard, the reduction shall be in the ratio of the actual to the standard height thereof.

Regulation 39 Minimum bow height and reserve buoyancy

- (1) The bow height (F_b), defined as the vertical distance at the forward perpendicular between the waterline corresponding to the assigned summer freeboard and the designed trim and the top of the exposed deck at side, shall be not less than:

$$F_b = (6075 (L/100) - 1875 (L/100)^2 + 200 (L/100)^3) \times (2,08 + 0,609C_b - 1,603C_{wf} - 0,0129 (L/d_1))$$

where:

F_b is the calculated minimum bow height, in mm;

L is the length, as defined in regulation 3, in m;

B is the moulded breadth, as defined in regulation 3, in m;

d_1 is the draught at 85% of the depth D , in m;

C_b is the block coefficient, as defined in regulation 3;

C_{wf} is the waterplane area coefficient forward of $L/2$: $C_{wf} = A_{wf} / \{(L/2) \times B\}$;

A_{wf} is the waterplane area forward of $L/2$ at draught $d1$, in m^2 .

For ships to which timber freeboards are assigned, the summer freeboard (and not the timber summer freeboard) is to be assumed when applying paragraph (1).

- (2) Where the bow height required in paragraph (1) is obtained by sheer, the sheer shall extend for at least 15% of the length of the ship measured from the forward perpendicular. Where it is obtained by fitting a superstructure, such superstructure shall extend from the stem to a point at least $0.07L$ abaft the forward perpendicular, and shall be enclosed as defined in regulation 3(10).
- (3) Ships which, to suit exceptional operational requirements, cannot meet the requirements of paragraphs (1) and (2) of this regulation may be given special consideration by the Administration.
- (4)
 - (4)(a) The sheer of the forecastle deck may be taken into account, even if the length of the forecastle is less than $0.15L$, but greater than $0.07L$, provided that the forecastle height is not less than one half of standard height of superstructure as defined in regulation 33 between $0.07L$ and the forward perpendicular.
 - (4)(b) Where the forecastle height is less than one half of the standard height of superstructure, as defined in regulation 33, the credited bow height may be determined as follows:
 - (4)(b)(i) Where the freeboard deck has sheer extending from abaft $0.15L$, by a parabolic curve having its origin at $0.15L$ abaft the forward perpendicular at a height equal to the midship depth of the ship, extended through the point of intersection of forecastle bulkhead and deck, and up to a point at the forward perpendicular not higher than the level of the forecastle deck (as illustrated in figure 39.1). However, if the value of the height denoted h_t in figure 39.1 is smaller than the value of the height denoted h_b then h_t may be replaced by h_b in the available bow height.
 - (4)(b)(ii) Where the freeboard deck has sheer extending for less than $0.15L$ or has no sheer, by a line from the forecastle deck at side at $0.07L$ extended parallel to the base line to the forward perpendicular (as illustrated in figure 39.2).

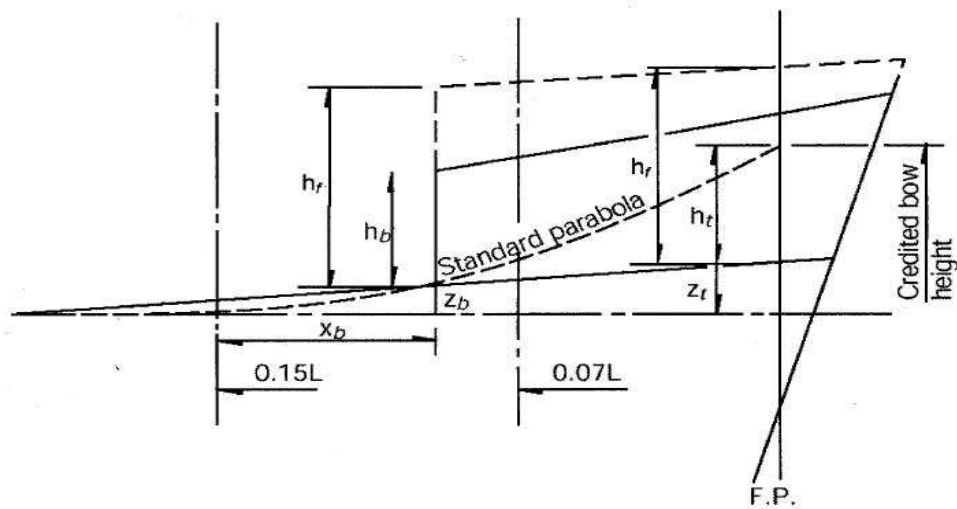

Figure 39.1

$$h_t = Z_b \left(\frac{0.15L}{x_b} \right)^2 - Z_t$$

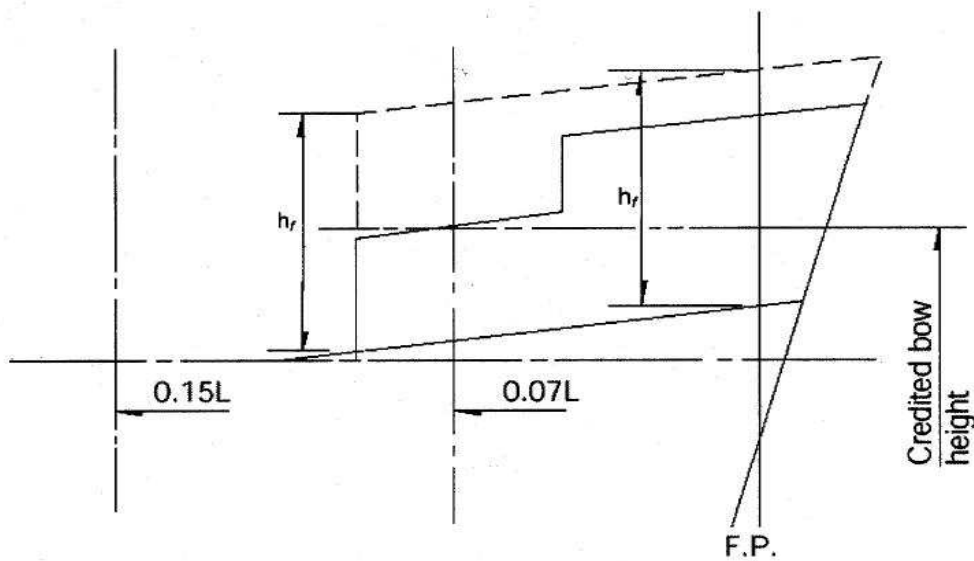

Figure 39.2

h_f = Half standard height of superstructure as defined in regulation 33.

- (5) All ships assigned a type 'B' freeboard, other than oil tankers*, chemical tankers* and gas carriers¹⁾, shall have additional reserve buoyancy in the fore end. Within the range of 0.15L abaft of the forward perpendicular, the sum of the projected area between the summer load waterline and the deck at side (A1 and A2 in figure 39.3) and the projected area of an enclosed superstructure, if fitted, (A3) shall not be less than:

¹⁾ Oil tankers, chemical tankers and gas carriers are defined in the International Convention for the Safety of Life at Sea (SOLAS), 1974, regulations II-1/2.12, VII/8.2 and VII/11.2, respectively.

$$(0,15 F_{\min} + 4 (L/3 + 10))L/1000 \text{ m}^2$$

where:

F_{\min} is calculated by: $F_{\min} = (F_0 \times f_1) + f_2$;

F_0 is the tabular freeboard, in mm, taken from table 28.2, corrected for regulation 27(9) or 27(10), as applicable;

f_1 is the correction for block coefficient given in regulation 30; and

f_2 is the correction for depth, in mm, given in regulation 31 .

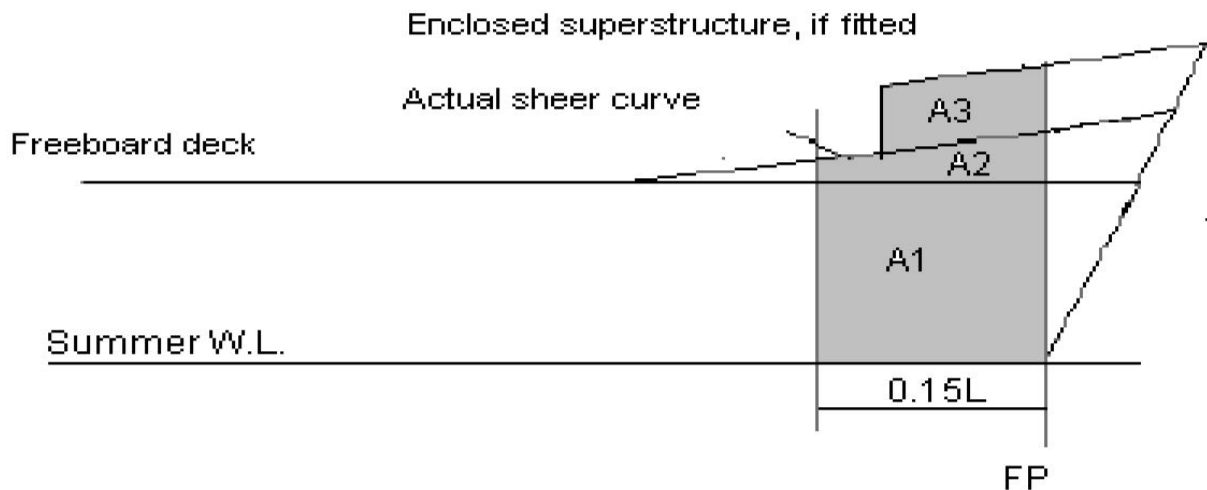

Figure 39.3

Regulation 40 Minimum freeboards

Summer freeboard

- (1) The minimum freeboard in summer shall be the freeboard derived from the tables in regulation 28, as modified by the corrections in regulations 27, as applicable, 29, 30, 31, 32, 37, 38 and, if applicable, 39.
- (2) The freeboard in salt water, as calculated in accordance with paragraph (1), but without the correction for deck line, as provided by regulation 32, shall not be less than 50 mm. For ships having in position 1 hatchways with covers which do not comply with the requirements of regulation 16(1) through (5) or regulation 26, the freeboard shall be not less than 150 mm.

Tropical freeboard

- (3) The minimum freeboard in the Tropical Zone shall be the freeboard obtained by a deduction from the summer freeboard of one forty-eighth of the summer draught measured from the top of the keel to the centre of the ring of the load line mark.

- (4) The freeboard in salt water, as calculated in accordance with paragraph (3), but without the correction for deck line, as provided by regulation 32, shall not be less than 50 mm. For ships having in position 1 hatchways with covers which do not comply with the requirements of regulation 16(1) through (5) or regulation 26, the freeboard shall be not less than 150 mm.

Winter freeboard

- (5) The minimum freeboard in winter shall be the freeboard obtained by an addition to the summer freeboard of one forty-eighth of summer draught, measured from the top of the keel to the centre of the ring of the load line mark.

Winter North Atlantic freeboard

- (6) The minimum freeboard for ships of not more than 100 m in length which enter any part of the North Atlantic defined in regulation 52 (Annex II) during the winter seasonal period shall be the winter freeboard plus 50 mm. For other ships, the winter North Atlantic freeboard shall be the winter freeboard.

Fresh water freeboard

- (7) The minimum freeboard in fresh water of unit density shall be obtained by deducting from the minimum freeboard in salt water:

$$\frac{\Delta}{40 T} \text{ cm}$$

where:

Δ is the displacement in salt water in tonnes at the summer load waterline; and

T is the tonnes per centimetre immersion in salt water at the summer load waterline.

- (8) Where the displacement at the summer load waterline cannot be certified, the deduction shall be one forty-eight of summer draught, measured from the top of the keel to the centre of the ring of the load line mark.

**Notice from the Danish Maritime Authority B –
The Construction and Equipment, etc. of Ships**

Chapter B II-5 A(I-IV)

**REVISED ARTICLES OF INTERNATIONAL CONVENTION ON LOAD
LINES, 1966**

INTERNATIONAL CONVENTION ON LOAD LINES, 1966

ANNEX I

REGULATIONS FOR DETERMINING LOAD LINES

CHAPTER IV

**SPECIAL REQUIREMENTS FOR SHIPS ASSIGNED TIMBER
FREEBOARD**

Regulation 41 Application of this chapter	1
Regulation 42 Definitions	1
Regulation 43 Construction of the ship.....	2
Regulation 44 Stowage	2
Regulation 45 Computation for freeboard	3

Regulation 41 Application of this chapter

Regulations 42 to 45 inclusive apply only to ships to which timber load lines are assigned.

Regulation 42 Definitions

- (1) Timber deck cargo. The term "timber deck cargo" means a cargo of timber carried on an uncovered part of a freeboard deck. The term does not include wood pulp or similar cargo¹⁾.
- (2) Timber load line. A timber deck cargo may be regarded as giving a ship a certain additional buoyancy and a greater degree of protection against the sea. For that reason, ships carrying a timber deck cargo may be granted a reduction of freeboard calculated according to the provisions of regulation 45 and marked on the ship's side in accordance with the provisions of

¹⁾ Reference is made to the Code of Safe Practice for Ships Carrying Timber Deck Cargoes, adopted by the Organization by resolution A.715(17), as amended.

regulations 6(3) and (4). However, in order that such special freeboard may be granted and used, the timber deck cargo shall comply with certain conditions which are laid down in regulation 44, and the ship itself shall also comply with certain conditions relating to its construction which are set out in regulation 43.

Regulation 43 Construction of the ship

Superstructure

- (1) Ships shall have a forecastle of at least standard height and a length of at least 0.07L. In addition, if the ship is less than 100 m in length, a poop of at least standard height, or a raised quarterdeck with a deckhouse of at least the same total height shall be fitted aft.

Double bottom tanks

- (2) Double bottom tanks, where fitted within the midship half length of the ship, shall have adequate watertight longitudinal subdivision.

Bulwarks

- (3) The ship shall be fitted either with permanent bulwarks at least 1 m in height, specially stiffened on the upper edge and supported by strong bulwark stays attached to the deck and provided with necessary freeing ports, or with efficient rails of the same height and of specially strong construction.

Regulation 44 Stowage

General

- (1) Openings in the deck exposed to weather over which cargo is stowed shall be securely closed and battened down.

The ventilators and air pipes shall be efficiently protected.

- (2) Timber deck cargoes shall extend over at least the entire available length which is the total length of the well or wells between superstructures.

Where there is no limiting superstructure at the after end, the timber shall extend at least to the after end of the aftermost hatchway.

The timber deck cargo shall extend athwartships as close as possible to the ship's side, due allowance being made for obstructions such as guard rails, bulwark stays, uprights, pilot access, etc., provided that any gap thus created at the side of the ship shall not exceed a mean of 4% of the breadth. The timber shall be stowed as solidly as possible to at least the standard height of the superstructure other than any raised quarterdeck.

- (3) On a ship within a seasonal winter zone in winter, the height of the deck cargo above the deck exposed to weather shall not exceed one third of the extreme breadth of the ship.
- (4) The timber deck cargo shall be compactly stowed, lashed and secured. It shall not interfere in any way with the navigation and necessary work of the ship.

Uprights

- (5) Uprights, when required by the nature of the timber, shall be of adequate strength considering the breadth of the ship; the strength of the uprights shall not exceed the strength of the

bulwark and the spacing shall be suitable for the length and character of timber carried, but shall not exceed 3 m. Strong angles or metal sockets or equally efficient means shall be provided for securing the uprights.

Lashings

- (6) Timber deck cargo shall be effectively secured throughout its length by a lashing system acceptable to the Administration for the character of the timber carried²⁾.

Stability

- (7) Provision shall be made for a safe margin of stability at all stages of the voyage, regard being given to additions of weight, such as those arising from absorption of water or icing, if applicable, and to losses of weight such as those arising from consumption of fuel and stores.

Protection of crew, access to machinery spaces, etc.

- (8) In addition to the requirements of regulation 25(5), guard-rails or lifelines not more than 350 mm apart vertically shall be provided on each side of the cargo deck to a height of at least 1 m above the cargo. In addition a lifeline, preferably wire rope set up taut with a stretching screw, shall be provided as near as practicable to the centreline of the ship. The stanchion supports to all guard-rails and lifelines shall be so spaced as to prevent undue sagging. Where the cargo is uneven, a safe walking surface of not less than 600 mm in width shall be fitted over the cargo and effectively secured beneath or adjacent to the lifeline.
- (9) Where the requirements prescribed in paragraph (8) are impracticable, alternative arrangements satisfactory to the Administration shall be used.

Steering arrangements

- (10) Steering arrangements shall be effectively protected from damage by cargo and, as far as practicable, shall be accessible. Efficient provision shall be made for steering in the event of a breakdown in the main steering arrangements.

Regulation 45 Computation for freeboard

- (1) The minimum summer freeboards shall be computed in accordance with regulations 27(5), 27(6), 27(14), 28, 29, 30, 31, 32, 37 and 38, except that regulation 37 is modified by substituting the following percentages for those given in regulation 37:

Table 45.1.

	Total Effective Length of Superstructure										
	0	0.1L	0.2L	0.3L	0.4L	0.5L	0.6L	0.7L	0.8L	0.9L	1.0L
Percentage of deduction for all types of superstructure	20	31	42	53	64	70	76	82	88	94	100

Percentages at intermediate lengths of superstructure shall be obtained by linear interpolation.

²⁾ Reference is made to the Code of Safe Practice for Ships Carrying Timber Deck Cargoes, adopted by the Organization by resolution A.715(17), as amended.

- (2) The Winter Timber Freeboard shall be obtained by adding to the Summer Timber Freeboard one thirty-sixth of the moulded summer timber draught.
- (3) The Winter North Atlantic Timber Freeboard shall be the same as the Winter North Atlantic Freeboard prescribed in regulation 40(6).
- (4) The Tropical Timber Freeboard shall be obtained by deducting from the Summer Timber Freeboard one forty-eighth of the moulded summer timber draught.
- (5) The Fresh Water Timber Freeboard shall be computed in accordance with regulation 40(7), based on the summer timber load waterline or with regulation 40(8), based on the summer timber draught measured from the top of the keel to the summer timber load line.
- (6) Timber freeboards may be assigned to ships with reduced type 'B' freeboards, provided the timber freeboards are calculated on the basis of the ordinary type 'B' freeboard.
- (7) The Timber Winter mark and/or the Timber Winter North Atlantic mark shall be placed at the same level as the reduced type 'B' Winter mark when the computed Timber Winter mark and/or the computed Timber Winter North Atlantic mark fall below the reduced type 'B' Winter mark.

**Notice from the Danish Maritime Authority B –
The Construction and Equipment, etc. of Ships**

Chapter B II-5 A(II)

**REVISED ARTICLES OF INTERNATIONAL CONVENTION ON LOAD
LINES, 1966**

INTERNATIONAL CONVENTION ON LOAD LINES, 1966

ANNEX II

ZONES, AREAS AND SEASONAL PERIODS

Regulation 46 Northern Winter Seasonal Zones and Area	1
Regulation 47 Southern Winter Seasonal Zone	3
Regulation 48 Tropical Zone	3
Regulation 49 Seasonal Tropical Areas	4
Regulation 50 Summer Zones	8
Regulation 51 Enclosed Seas	8
Regulation 52 The Winter North Atlantic Load Line	9

The zones and areas in this Annex are, in general, based on the following criteria :

Summer - not more than 10 per cent winds of force 8 Beaufort (34 knots) or more.

Tropical - not more than 1 per cent winds of force 8 Beaufort (34 knots) or more.

Not more than one tropical storm in 10 years in an area of 5°square in any one separate calendar month.

In certain special areas, for practical reasons, some degree of relaxation has been found acceptable. A chart is attached to this Annex to illustrate the zones and areas defined below.

Regulation 46 Northern Winter Seasonal Zones and Area

(1) North Atlantic Winter Seasonal Zones I and II.

(1)(a) The North Atlantic Winter Seasonal Zone I lies within the meridian of longitude 50°W from the coast of Greenland to latitude 45°N, thence the parallel of latitude 45°N to longitude 15°W, thence the meridian of longitude 15°W to latitude 60°N, thence the parallel of latitude 60°N to the Greenwich Meridian, thence this meridian northwards.

Seasonal periods :

WINTER : 16 October to 15 April

SUMMER : 16 April to 15 October

- (1)(b) The North Atlantic Winter Seasonal Zone II lies within the meridian of longitude 68°30'W from the coast of the United States to latitude 40°N, thence the rhumb line to the point latitude 36°N, longitude 73°W, thence the parallel of latitude 36°N to longitude 25°W and thence the rhumb line to Cape Torinana. Excluded from this zone are the North Atlantic winter seasonal zone I, the North Atlantic winter seasonal area and the Baltic Sea bounded by the parallel of latitude of the Skaw in the Skagerrak. The Shetland Islands are to be considered as being on the boundary of the North Atlantic winter seasonal zones I and II.

Seasonal periods :

WINTER : 1 November to 31 March

SUMMER : 1 April to 31 October

- (2) North Atlantic Winter Seasonal Area

The boundary of the North Atlantic Winter Seasonal Area is - the meridian of longitude 68°0'W from the coast of the United States to latitude 40°N, thence the rhumb line to the southernmost intersection of the meridian of longitude 61°W with the coast of Canada and thence the east coasts of Canada and the United States.

Seasonal periods :

For ships over 100 m (328 feet) in length:

WINTER : 16 December to 15 February

SUMMER : 16 February to 15 December

For ships of 100 m (328 feet) and under in length:

WINTER : 1 November to 31 March

SUMMER : 1 April to 31 October

- (3) North Pacific Winter Seasonal Zone

The southern boundary of the North Pacific Winter Seasonal Zone is - the parallel of latitude 50°N from the east coast of the USSR to the west coast of Sakhalin, thence the west coast of Sakhalin to the southern extremity of Cape Kuril'on, thence the rhumb line to Wakkanai,

Hokkaido, Japan, thence the east and south coasts of Hokkaido to longitude 145°E, thence the meridian of longitude 145°E to latitude 35°N, thence the Parallel of latitude 35°N to longitude 150°W and thence the rhumb line to the southern extremity of Dall Island, Alaska.

Seasonal periods :

WINTER : 16 October to 15 April

SUMMER : 16 April to 15 October

Regulation 47 Southern Winter Seasonal Zone

The northern boundary of the Southern Winter Seasonal Zone is:

The rhumb line from the east coast of the American continent at Cape Tres Puntas to the point latitude 34°S, longitude 50°W, thence the parallel of latitude 34°S to longitude 17°E, thence the rhumb line to the point latitude 35°10'S, longitude 20°E, thence the rhumb line to the point latitude 34°S, longitude 28°E, thence along the rhumb line to the point latitude 35°30'S; longitude 118°E, and thence the rhumb line to Cape Grim on the northwest coast of Tasmania; thence along the north and east coasts of Tasmania to the southernmost point of Bruny Island, thence the rhumb line to Black Rock Point on Stewart Island, thence the rhumb line to the point latitude 47°S, longitude 170°E, thence along the rhumb line to the point latitude 33°S; longitude 170°W, and thence the parallel of latitude 33°S to the point latitude 33°S, longitude 79°W, thence the rhumb line to the point latitude 41°S, longitude 75°W, thence the rhumb line to Punta Corona lighthouse on Chiloe Island, latitude 41°47'S, longitude 73°53'W, thence along the north, east and south coasts of Chiloe Island to the point latitude 43°20'S, longitude 74°20'W, and thence the meridian of longitude 74°20'W to the parallel of latitude 45°45'S, including the inner zone of Chiloe channels from the meridian 74°20'W to the east.

Seasonal periods :

WINTER : 16 April to 15 October

SUMMER : 16 October to 15 April

Regulation 48 Tropical Zone

(1) Northern Boundary of the Tropical Zone

The northern boundary of the Tropical Zone is:

The parallel of latitude 13°N from the east coast of the American continent to longitude 60°W, thence the rhumb line to the point latitude 10°N, longitude 58°W, thence the parallel of latitude 10°N to longitude 20°W, thence the meridian of longitude 20°W to latitude 30°N and thence the parallel of latitude 30°N to the west coast of Africa; from the east coast of Africa the parallel of latitude 8°N to longitude 70°E, thence the meridian of longitude 70°E to latitude 13°N, thence the parallel of latitude 13°N to the west coast of India; thence the south coast of India to latitude 10°30'N on the east coast of India, thence the rhumb line to the point latitude 9°N, longitude 82°E, thence the meridian of longitude 82°E to latitude 8°N, thence the parallel of latitude 8°N to the west coast of Malaysia, thence the coast of South-East Asia

to the east coast of Viet-Nam at latitude 10°N , thence the parallel of latitude 10°N to longitude 145°E , thence the meridian of longitude 145°E to latitude 13°N and thence the parallel of latitude 13°N to the west coast of the American continent.

Saigon is to be considered as being on the boundary line of the Tropical Zone and the Seasonal Tropical Area.

(2) Southern Boundary of the Tropical Zone

The southern boundary of the Tropical Zone is:

The rhumb line from the Port of Santos, Brazil, to the point where the meridian of longitude 40°W intersects the Tropic of Capricorn; thence the Tropic of Capricorn to the west coast of Africa; from the east coast of Africa the parallel of latitude 20°S to the west coast of Madagascar, thence the west and north coasts of Madagascar to longitude 50°E , thence the meridian of longitude 50°E to latitude 10°S , thence the parallel of latitude 10°S to longitude 98°E , thence the rhumb line to Port Darwin, Australia, thence the coasts of Australia and Wessel Island eastwards to Cape Wessel, thence the parallel of latitude 11°S to the west side of Cape York; from the east side of Cape York the parallel of latitude 11°S to longitude 150°W , thence the rhumb line to the point latitude 26°S , longitude 75°W , thence the rhumb line to the point latitude $32^{\circ}47'\text{S}$, longitude 72°W , and thence to the parallel of latitude $32^{\circ}47'\text{S}$ to the west coast of South America.

Valparaiso and Santos are to be considered as being on the boundary line of the Tropical and Summer Zones.

(3) Areas to be included in the Tropical Zone

The following areas are to be treated as included in the Tropical Zone –

- (3)(a) The Suez Canal, the Red Sea and the Gulf of Aden, from Port Said to the meridian of longitude 45°E . Aden and Berbera are to be considered as being on the boundary line to the Tropical Zone and the Seasonal Tropical Area.
- (3)(b) The Persian Gulf to the meridian of longitude 59°E .
- (3)(c) The area bounded by the parallel of latitude 22°S from the east coast of Australia to the Great Barrier Reef, thence the Great Barrier Reef to latitude 11°S . The northern boundary of the area is the southern boundary of the Tropical Zone.

Regulation 49 Seasonal Tropical Areas

The following are Seasonal Tropical Areas:

(1) In the North Atlantic

An area bounded –

on the north by the rhumb line from Cape Catoche, Yucatan, to Cape San Antonio, Cuba, the north coast of Cuba to latitude 20°N and thence the parallel of latitude 20°N to longitude 20°W ;

on the west by the coast of the American continent;

on the south and east by the northern boundary of the Tropical Zone.

Seasonal periods:

TROPICAL : 1 November to 15 July

SUMMER : 16 July to 31 October

(2) In the Arabian Sea

An area bounded -

on the west by the coast of Africa, the meridian of longitude 45°E in the Gulf of Aden, the coast of South Arabia and the meridian of longitude 59°E in the Gulf of Oman;

on the north and east by the coasts of Pakistan and India;

on the south by the northern boundary of the Tropical Zone

Seasonal periods :

TROPICAL : 1 September to 31 May

SUMMER : 1 June to 31 August

(3) In the Bay of Bengal

The Bay of Bengal north of the northern boundary of the Tropical Zone.

Seasonal periods :

TROPICAL : 1 December to 30 April

SUMMER : 1 May to 30 November

(4) In the South Indian Ocean

(4)(a) An area bounded –

on the north and west by the southern boundary of the Tropical Zone and the east coast of Madagascar;

on the south by the parallel of latitude 20°S;

on the east by the rhumb line from the point latitude 20°S, longitude 50°E, to the point latitude 15°S, longitude 51°30'E, and thence by the meridian of longitude 51°30'E to latitude 10°S.

Seasonal periods :

TROPICAL : 1 April to 30 November

SUMMER : 1 December to 31 March

(4)(b) An area bounded -

on the north by the southern boundary of the Tropical Zone;

on the east by the coast of Australia;

on the south by the parallel of latitude 15°S from longitude 51°30'E, to longitude 114°E and thence the meridian of longitude 114°E to the coast of Australia.

on the west by the meridian of longitude 51°30'E.

Seasonal periods:

TROPICAL : 1 May to 30 November

SUMMER : 1 December to 30 April

(5) In the China Sea

An area bounded -

on the west and north by the coasts of Viet-Nam and China from latitude 10°N to Hong Kong;

on the east by the rhumb line from Hong Kong to the Port of Sual (Luzon Island) and the west coasts of the Islands of Luzon, Samar and Leyte to latitude 10°N;

on the south by the parallel of latitude 10°N.

Hong Kong and Sual are to be considered as being on the boundary of the Seasonal Tropical Area and Summer Zone.

Seasonal periods :

TROPICAL : 21 January to 30 April

SUMMER : 1 May to 20 January

(6) In the North Pacific.

(6)(a) An area bounded –

on the north by the parallel of latitude 25°N;
on the west by the meridian of longitude 160°E;
on the south by the parallel of latitude 13°N;
on the east by the meridian of longitude 130°W.

Seasonal periods :

TROPICAL : 1 April to 31 October

SUMMER : 1 November to 31 March

(6)(b) An area bounded –

on the north and east by the west coast of the American continent;

on the west by the meridian of longitude 123°W from the coast of the American continent to latitude 33°N and by the rhumb line from the point latitude 33°N, longitude 123°W, to the point latitude 13°N, longitude 105°W;

on the south by the parallel of latitude 13°N.

Seasonal periods :

TROPICAL : 1 March to 30 June and 1 November to 30 November

SUMMER : 1 July to 31 October and 1 December to 28/29 February

(7) In the South Pacific

(7)(a) The Gulf of Carpentaria south of latitude 11°S.

Seasonal periods :

TROPICAL : 1 April to 30 November

SUMMER : 1 December to 31 March

(7)(b) An area bounded :

on the north and east by the southern boundary of the Tropical Zone;

on the south by the parallel of latitude of 24°S from the east coast of Australia to longitude 154°E, thence by the meridian of longitude 154°E to the Tropic of Capricorn and thence by the Tropic of Capricorn to longitude 150°W, thence by the meridian of longitude 150°W to latitude 20°S and thence by the parallel of latitude 20°S to the point where it intersects the southern boundary of the Tropical Zone; and

on the west by the boundaries of the area within the Great Barrier Reef included in the Tropical Zone and by the east coast of Australia.

Seasonal periods:

TROPICAL : 1 April to 30 November

SUMMER : 1 December to 31 March

Regulation 50 Summer Zones

The remaining areas constitute the Summer Zones.

However, for ships of 100 metres (328 feet) and under in length, the area bounded - on the north and west by the east coast of the United States;

on the east by the meridian of longitude 68°30'W from the coast of the United States to latitude 40°N and thence by the rhumb line to the point latitude 36°N, longitude 73° W;

on the south by the parallel of latitude 36°N;

is a Winter Seasonal Area.

Seasonal periods:

WINTER : 1 November to 31 March

SUMMER : 1 April to 31 October

Regulation 51 Enclosed Seas

(1) Baltic Sea

This sea bounded by the parallel of latitude of The Skaw in the Skagerrak is included in the Summer Zones.

However, for ships of 100 metres (328 feet) and under in length, it is a Winter Seasonal Area.

Seasonal periods :

WINTER : 1 November to 31 March

SUMMER : 1 April to 31 October

(2) Black Sea.

This sea is included in the Summer Zones.

However, for ships of 100 metres (328 feet) and under in length, the area north of latitude 44 N is a Winter Seasonal Area.

Seasonal periods :

WINTER : 1 December to 28/29 February

SUMMER : 1 March to 30 November

(3) Mediterranean

This sea is included in the Summer Zones.

However, for ships of 100 metres (328 feet) and under in length, the area bounded- on the north and west by the coasts of France and Spain and the meridian of longitude 3 E from the coast of Spain to latitude 40 N;

on the south by the parallel of latitude 40 N from longitude 3 E to the west coast of Sardinia;

on the east by the west and north coasts of Sardinia from latitude 40 N to longitude 9 E, thence by the meridian of longitude 9 E to the south coast of Corsica, thence by the west and north coasts of Corsica to longitude 9 E and thence by the rhumb line to Cape Sicie;

is a Winter Seasonal Area.

Seasonal periods :

WINTER: 16 December to 15 March

SUMMER: 16 March to 15 December

(4) Sea of Japan

This sea south of latitude 50 N is included in the Summer Zones. However, for ships of 100 metres (328 feet) and under in length, the area between the parallel of latitude 50 N and the rhumb line from the east coast of Korea at latitude 38 N to the west coast of Hokkaido, Japan, at latitude 43 12'N is a Winter Seasonal Area.

Seasonal periods :

WINTER: 1 December to 28/29 February

SUMMER: 1 March to 30 November

Regulation 52 The Winter North Atlantic Load Line

The part of the North Atlantic referred to in Regulation 40(6) (Annex I) comprises :

- (1)(a) that part of the North Atlantic Winter Seasonal Zone II which lies between the meridians of 15°W and 50°W;

(1)(b) the whole of the North Atlantic Winter Seasonal Zone I, the Shetland Islands to be considered as being on the boundary.

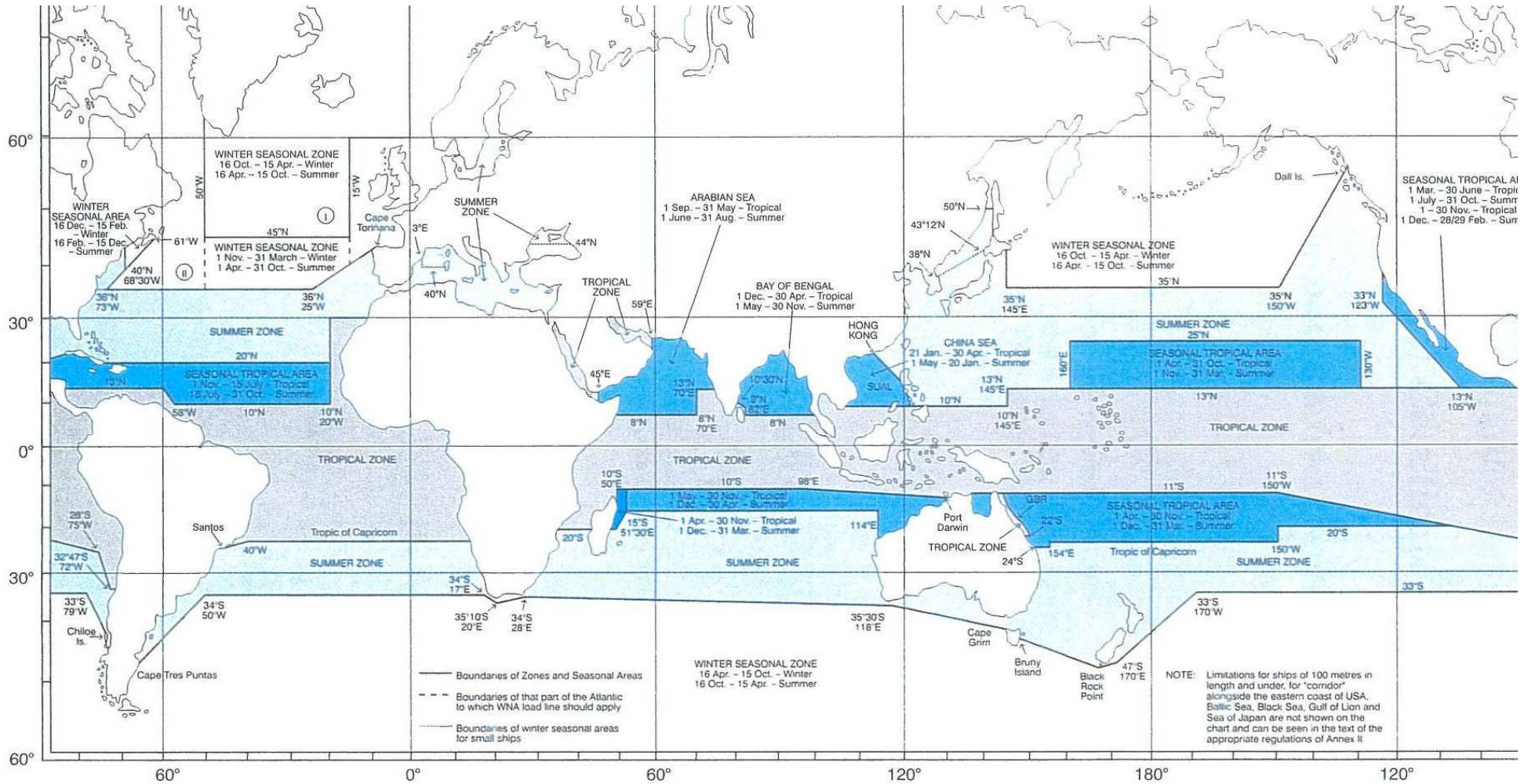

APPENDIX III

Certificates

Reference is made to the Load Line Certificates in Annex 1 B to this set of regulations.

**Notice from the Danish Maritime Authority B –
The Construction and Equipment, etc. of Ships**

Chapter B II-5 N

Load Lines

<i>Regulation 1 – Application</i>	1
<i>Regulation 2 – Exceptions</i>	1
<i>Regulation 3 – Definitions</i>	1
<i>Regulation 3 – Exemptions</i>	1
<i>Regulation 4 – Protection of the crew</i>	2
<i>Regulation 5 – Guard rails on passenger ships</i>	2
<i>Regulation 6 – Application</i>	2
<i>Regulation 7 – Structure and freeboard-related conditions</i>	3
<i>Regulation 8 – Marking</i>	3
<i>Regulation 9 – Surveys and Certificates</i>	3
<i>Regulation 10 – Application</i>	3
<i>Regulation 11 – Structure and freeboard-related conditions</i>	3
<i>Regulation 12 – Marking</i>	4
<i>Regulation 13 – Surveys and Certificates</i>	4

Regulation 1 – Application

1. This Chapter contains regulations implementing, expanding or deviating from the provisions of the Convention on Load Lines.
2. Unless expressly provided otherwise, this Chapter shall apply to ships of a length of or above 24 m and to ships below 24 m the keels of which are laid on or after 1 January 2002.

Regulation 2 – Exceptions

This Chapter shall not apply to the ships mentioned in Chapter I, Regulation 3.

Regulation 3 – Definitions

1. The Convention on Load Lines is the International Convention on Load Lines of 5 April 1966, as amended by the Protocol of 1988.
2. "Length": as defined in Annex I, Regulation 3 (1) to the Convention on Load Lines.

Regulation 3 – Exemptions

In addition to the possibilities of exemptions mentioned in Article 6 of the Convention on Load Lines, the Danish Maritime Authority may allow deviations from the provisions in this Chapter if the following applies to each individual ship:

- 1.1. the ship is only engaged in domestic trade, and

- 1.2. *navigation in the allocated area of trade takes place under conditions so protected that full application of the regulations would be unreasonable or unnecessary.*

Regulation 4 – Protection of the crew

Arrangements for the protection of the crew, as stipulated in Regulation 25(4) and in Regulation 26(2) and (3) of the Convention on Load Lines and in Chapter II-1, Regulation 3-3 of these Regulations for tankers, shall be carried out in accordance with the rules of a recognized classification society and the interpretations and guidelines of IACS.)*

Regulation 5 – Guard rails on passenger ships

1. *On the decks to which passengers are given access and where there is no bulwark of adequate height, passenger ships shall be provided with guard rails that comply with the following provisions:*
 - 1.1. *The total height of the guard rail shall be at least 1000 mm, measured from the deck.*
 - 1.2. *The guard rail shall be constructed with vertical bars, which are connected only to one upper and one lower horizontal bar or stringer.*
 - 1.3. *The distance between the upper and lower horizontal bars/stringers referred to in the above 1.2 shall not be less than 800 mm.*
 - 1.4. *The opening below the horizontal bar referred to in the above 1.2 shall not exceed 120 mm.*
 - 1.5. *The distance between the vertical bars may not exceed 120 mm, and the distance between sceptres may not exceed 1.5 m.*
2. *External staircases, landings etc. shall be provided with guard railings of equivalent construction.*
3. *The decks that are effectively barred against the presence and passage of passengers shall either be provided with guard railings complying with the above 1.1-1.5 or railings/bulwarks as prescribed in the Convention on Load Lines.*
4. *No arrangement inferior to a guard railing or a gate that complies with the above 1.1-1.5 will be approved as an effective barrier.*
5. *Where a gate is used, the closing mechanism shall not be immediately accessible to the passengers, and adequate signs shall be provided.*
6. *The Danish Maritime Authority may permit deviations from the above on the condition that the required safety level to prevent forcing and falling is achieved.*

Part A – Load lines for ships with a length of 24 m or more

Regulation 6 – Application

1. *This section shall apply to ships of a length of 24 m or more.*
2. *Ships the keels of which are laid before 1 January 2002 and only engaged in domestic trade shall comply with the regulations in force until then. For ships with a gross tonnage below 500, the provisions on surveys and certificates in Regulation 13 shall apply, and for ships with a gross tonnage of 500 or more, surveys of the freeboard-related conditions shall be carried out in connection with the surveys stipulated in Chapter I, Regulation 10 (a) (ii).*

**) The International Association of Classification Societies.*

Regulation 7 – Structure and freeboard-related conditions^{)}**

Unless expressly provided otherwise in this section, ships engaged on both domestic and international voyages shall comply with the provisions of the Convention on Load Lines.

Regulation 8 – Marking^{*)}**

- 1. Load line marks shall be marked D-L to indicate the authority assigning load lines.*
- 2. For ships flagged in from abroad, it may be accepted that the existing letters intended to indicate the classification society of the ship as the authority that assigns load lines are maintained.*
- 3. The stem and stern post shall be provided with draught marks in decimetres on both sides. Such marks shall be placed as close to the perpendiculars as possible.*

Regulation 9 – Surveys and Certificates

- 1. Freeboard-related conditions shall be surveyed in accordance with the provisions of Article 14 of the Convention on Load Lines.*
- 2. An international load line certificate shall be issued to ships that have been surveyed and marked in accordance with the Convention on Load Lines and that comply with these Regulations.*
- 3. The validity and duration of certificates have been laid down in Article 19 of the Convention on Load Lines.*
- 4. Classification societies recognized by the Danish Maritime Authority in accordance with the provisions of Chapter XI, Regulation 1 shall be authorized to carry out freeboard calculations and freeboard surveys as well as to issue and endorse load line certificates.*

Part B – Load lines for ships with a length below 24 m

Regulation 10 – Application

- 1. This section shall apply to ships of a length below 24 m.*
- 2. Ships the keels of which are laid before 1 January 2002 shall comply with the regulations in force until then. For these ships, the regulations on surveys and certificates in Regulation 13 shall be complied with.*

Regulation 11 – Structure and freeboard-related conditions^{**)}**

- 1. Ships shall maintain a safety level satisfying the criteria of the Convention on Load Lines.*
- 2. The freeboard shall be assigned on the basis of the criteria of the Convention on Load Lines in consideration of the hull strength, stability, buoyancy and service area of the ship.*
- 3. The freeboard shall be assigned on the basis of a table freeboard of 200 mm and shall be corrected with the relevant parameters in the Convention on Load Lines. In cases where parameter values are not readily deductible from the Convention on Load Lines, values used for ships with a length of 24 m shall be used.*
- 4. Normally, the freeboard in cargo ships may not be below 150 mm, however, under special conditions and in consideration of the season and the durability of the voyage, a smaller freeboard*

^{**)} Reference is also made to Chapter II-1, Regulation 13, on sub-division load lines in passenger ships.

^{***)} Reference is also made to Chapter II-1, Regulation 13, on sub-division load lines in passenger ships.

^{****)} Reference is also made to Chapter II-1, Regulation 13, on sub-division load lines in passenger ships.

may be permitted, but it may never be below 50 mm (cf. Regulation 40 of the Convention on Load Lines).

Regulation 12 – Marking ^{*****)}

1. Deck line and load line marks shall be made as stipulated in the Convention on Load Lines, but without the letters D-L. For small ships, the load line mark may be made with a smaller diameter, however not below an external diameter of 200 mm.
2. The stem and stern post shall be provided with draught marks in decimetres on both sides. Such marks shall be placed as close to the perpendiculars as possible.

Regulation 13 – Surveys and Certificates

1. Passenger ships
 - 1.1. The freeboard-related conditions shall be surveyed in connection with the surveys of passenger ships mentioned in Chapter I, Regulation 7.
 - 1.2. A freeboard certificate shall be issued when a freeboard has been approved by the Danish Maritime Authority and when it has been ascertained at a satisfactory survey that these regulations have been complied with.
 - 1.3. Freeboard certificates shall be issued by the Danish Maritime Authority.
2. Cargo ships
 - 2.1. The freeboard-related conditions shall be surveyed in connection with the surveys of cargo ships mentioned in Chapter I, Regulation 10-1.
 - 2.2. The minimum freeboard shall be indicated on the safety certificate for cargo ships mentioned in Chapter I, Regulation 12-1.

*****) Reference is also made to Chapter II-1, Regulation 13, on sub-division load lines in passenger ships.

Notice from the Danish Maritime Authority B – The Construction and Equipment, etc. of Ships

Chapter B III

Life-saving appliances and arrangements

Regulation 1 – Application	1
Regulation 2 – Exemptions.....	2
Regulation 3 – Definitions	2
Regulation 4 – Evaluation, testing and approval of life-saving appliances and arrangements.....	4
Regulation 5 – Production tests	4

Part A – General

Regulation 1 – Application

1. Unless expressly provided otherwise, this chapter shall apply to *passenger ships, regardless of size, and cargo ships with a gross tonnage of 500 or more* the keels of which are laid or which are at a similar stage of construction on or after 1 July 1998 *and to cargo ships with a gross tonnage below 500, the keels of which are laid on or after 1 January 2002.*
2. For the purpose of this chapter the term “a similar stage of construction” means the stage at which:
 - 2.1. construction identifiable with a specific ship begins; and
 - 2.2. assembly of that ship has commenced comprising at least 50 tonnes or 1% of the estimated mass of all structural material, whichever is less.
3. For the purpose of this chapter:
 - 3.1. the expression “ships constructed” means “ships the keels of which are laid or which are at a similar stage of construction”;
 - 3.2. the expression “all ships” means *passenger ships, regardless of size and cargo ships with a gross tonnage of 500 or more* constructed before, on or after 1 July 1998 *and cargo ships with a gross tonnage below 500 constructed on or after 1 January 2002*; the expressions “all passenger ships” and “all cargo ships” shall be construed accordingly;
 - 3.3. a cargo ship, whenever built, which is converted to a passenger ship shall be treated as a passenger ship constructed on the date on which such a conversion commences.
4. For *cargo ships with a gross tonnage above 500 and passenger ships, regardless of size, constructed before 1 July 1998*, the Administration shall:
 - 4.1. ensure that, subject to the provisions of paragraph 4.2 and 4.3, the requirements which are applicable under chapter III of the International Convention for the Safety of Life at Sea, 1974, in force prior to 1 July 1998 to new or existing ships as prescribed by that chapter are complied with; and
 - 4.2. ensure that when life-saving appliances or arrangements on such ships are replaced or such ships undergo repairs, alterations or modifications of a major character which involve replacement of, or any addition to, their existing lifesaving appliances or arrangements, such life-saving appliances or arrangements, in so far as is reasonable and practicable, comply with the requirements of this chapter. However, if a survival craft other than an

inflatable liferaft is replaced without replacing its launching appliance, or vice versa, the survival craft or launching appliance may be of the same type as that replaced.

Regulation 2 – Exemptions

1. The Administration may, if it considers that the sheltered nature and conditions of the voyage are such as to render the application of any specific requirements of this chapter unreasonable or unnecessary, exempt from those requirements individual ships or classes of ships which, in the course of their voyage, do not proceed more than 20 miles from the nearest land.
2. In the case of passenger ships which are employed in special trades for the carriage of large numbers of special trade passengers, such as the pilgrim trade, the Administration, if satisfied that it is impracticable to enforce compliance with the requirements of this chapter, may exempt such ships from those requirements, provided that such ships comply fully with the provisions of:
 - 2.1. the rules annexed to the “Special Trade Passenger Ships Agreement, 1971”; and
 - 2.2. the rules annexed to the “Protocol on Space Requirements for Special Trade Passenger Ships, 1973.”

Regulation 3 – Definitions

For the purpose of this chapter, unless expressly provided otherwise:

1. “Anti-exposure suit” is a protective suit designed for use by rescue boat crews and marine evacuation system parties.
2. “Certificated person” is a person who holds a certificate of proficiency in survival craft issued under the authority of, or recognized as valid by, the Administration in accordance with the requirements of the International Convention on Standards of Training, Certification and Watchkeeping for Seafarers, in force; or a person who holds a certificate issued or recognized by the Administration of a State not a Party to that Convention for the same purpose as the convention certificate.
3. “Detection” is the determination of the location of survivors or survival craft.
4. “Embarkation ladder” is the ladder provided at survival craft embarkation stations to permit safe access to survival craft after launching.
5. “Float-free launching” is that method of launching a survival craft whereby the craft is automatically released from a sinking ship and is ready for use.
6. “Free-fall launching” is that method of launching a survival craft whereby the craft with its complement of persons and equipment on board is released and allowed to fall into the sea without any restraining apparatus.
7. “Immersion suit” is a protective suit which reduces the body heat loss of a person wearing it in cold water. *In Danish ships immersion suits shall be in accordance with 2.3.2.2 of the Code.*
8. “Inflatable appliance” is an appliance which depends upon non-rigid, gas-filled chambers for buoyancy and which is normally kept uninflated until ready for use.
9. “Inflated appliance” is an appliance which depends upon non-rigid, gas-filled chambers for buoyancy and which is kept inflated and ready for use at all times.
10. “International Life-Saving Appliance (LSA) Code” (referred to as "the Code" in this chapter) means the International Life-Saving Appliance (LSA) Code adopted by the Maritime Safety Committee of the Organization by resolution MSC.48(66), as it may be amended by the Organization, provided that such amendments are adopted, brought into force and take effect in accordance with the provisions of article VIII of the present Convention concerning the amendment procedures applicable to the annex other than chapter I.

11. "Launching appliance or arrangement" is a means of transferring a survival craft or rescue boat from its stowed position safely to the water.
12. "Length" is 96% of the total length on a waterline at 85% of the least moulded depth measured from the top of the keel, or the length from the fore-side of the stem to the axis of the rudder stock on that waterline, if that be greater. In ships designed with a rake of keel the waterline on which this is measured shall be parallel to the designed waterline.
13. "Lightest seagoing condition" is the loading condition with the ship on even keel, without cargo, with 10% stores and fuel remaining and in the case of a passenger ship with the full number of passengers and crew and their luggage.
14. "Marine evacuation system" is an appliance for the rapid transfer of persons from the embarkation deck of a ship to a floating survival craft.
- 15. "Moulded depth"**
 - 15.1. "The moulded depth" is the vertical distance measured from the top of the keel to the top of the freeboard deck beam at side. In wood and composite ships the distance is measured from the lower edge of the keel rabbet. Where the form at the lower part of the midship section is of a hollow character, or where thick garboards are fitted, the distance is measured from the point where the line of the flat of the bottom continued inwards cuts the side of the keel.
 - 15.2. In ships having rounded gunwales, the moulded depth shall be measured to the point of intersection of the moulded lines of the deck and side shell plating, the lines extending as though the gunwale were of angular design.
 - 15.3. Where the freeboard deck is stepped and the raised part of the deck extends over the point at which the moulded depth is to be determined, the moulded depth shall be measured to a line of reference extending from the lower part of the deck along a line parallel with the raised part.
16. "Novel life-saving appliance or arrangement" is a lifesaving appliance or arrangement which embodies new features not fully covered by the provisions of this chapter or the Code but which provides an equal or higher standard of safety.
17. "Positive stability" is the ability of a craft to return to its original position after the removal of a heeling moment.
18. "Recovery time" for a rescue boat is the time required to raise the boat to a position where persons on board can disembark to the deck of the ship. Recovery time includes the time required to make preparations for recovery on board the rescue boat such as passing and securing a painter, connecting the rescue boat to the launching appliance, and the time to raise the rescue boat. Recovery time does not include the time needed to lower the launching appliance into position to recover the rescue boat.
19. "Rescue boat" is a boat designed to rescue persons in distress and to marshal survival craft.
20. "Retrieval" is the safe recovery of survivors.
21. "Ro-ro passenger ship" means a passenger ship with ro-ro cargo spaces or special category spaces as defined in regulation II-2/3.
22. "Short international voyage" is an international voyage in the course of which a ship is not more than 200 miles from a port or place in which the passengers and crew could be placed in safety. Neither the distance between the last port of call in the country in which the voyage begins and the final port of destination nor the return voyage shall exceed 600 miles. The final port of destination is the last port of call in the scheduled voyage at which the ship commences its return voyage to the country in which the voyage began.
23. "Survival craft" is a craft capable of sustaining the lives of persons in distress from the time of abandoning the ship.

24. “Thermal protective aid” is a bag or suit made of waterproof material with low thermal conductance, which also complies with the provisions of regulation 34.

Regulation 4 – Evaluation, testing and approval of life-saving appliances and arrangements

1. Except as provided in paragraphs 5 and 6, life-saving appliances and arrangements required by this chapter shall be approved by the Administration.
2. Before giving approval to life-saving appliances and arrangements, the Administration shall ensure that such life-saving appliances and arrangements:
 - 2.1. are tested, to confirm that they comply with the requirements of this chapter and the Code, in accordance with the recommendations of the Organization¹; or
 - 2.2. have successfully undergone, to the satisfaction of the Administration, tests which are substantially equivalent to those specified in those recommendations.
3. Before giving approval to novel life-saving appliances or arrangements, the Administration shall ensure that such:
 - 3.1. appliances provide safety standards at least equivalent to the requirements of this chapter and the Code and have been evaluated and tested based on the guidelines developed by the Organization²; or
 - 3.2. arrangements have successfully undergone an engineering analysis, evaluation and approval in accordance with regulation 38.
4. Procedures adopted by the Administration for approval shall also include the conditions whereby approval would continue or would be withdrawn.
5. Before accepting life-saving appliances and arrangements that have not been previously approved by the Administration, the Administration shall be satisfied that life-saving appliances and arrangements comply with the requirements of this chapter and the Code.
6. Life-saving appliances required by this chapter for which detailed specifications are not included in the Code shall be to the satisfaction of the Administration.

Regulation 5 – Production tests

The Administration shall require life-saving appliances to be subjected to such production tests as are necessary to ensure that the life-saving appliances are manufactured to the same standard as the approved prototype.

¹ Refer to the Revised Recommendations on testing of life-saving appliances adopted by the Maritime Safety Committee of the Organization by resolution MSC.81 (70).

² Refer to the guidelines to be developed by the Organization.

**Notice from the Danish Maritime Authority B –
The Construction and Equipment, etc. of Ships
Chapter B III
Lifesaving appliances and arrangements**

Regulation 6 – Communications.....	2
Regulation 7 – Personal life-saving appliances	3
Regulation 8 – Muster list and emergency instructions.....	5
Regulation 9 – Operating instructions	5
Regulation 10 – Manning of survival craft and supervision.....	5
Regulation 11 – Survival craft muster and embarkation arrangements	6
Regulation 12 – Launching stations.....	6
Regulation 13 – Stowage of survival craft.....	6
Regulation 14 – Stowage of rescue boats	7
Regulation 15 – Stowage of marine evacuation systems.....	8
Regulation 16 – Survival craft launching and recovery arrangements	8
Regulation 17 – Rescue boat embarkation, launching and recovery arrangements.....	9
Regulation 18 – Line-throwing appliances	9
Regulation 19 – Emergency training and drills	9
Regulation 20 – Operational readiness, maintenance and inspections	12
Regulation 21 – Survival craft and rescue boats.....	15
Regulation 22 – Personal life-saving appliances	17
Regulation 23 – Survival craft and rescue boat embarkation arrangements.....	18
Regulation 24 – Stowage of survival craft.....	19
Regulation 25 – Muster stations.....	19
Regulation 26 – Additional requirements for ro-ro passenger ships	19
Regulation 27 – Information on passengers.....	21
Regulation 28 – Helicopter landing and pick-up areas	21
Regulation 29 – Decision support system for masters of passenger ships.....	21
Regulation 30 – Drills	22
Regulation 31 – Survival craft and rescue boats.....	22
Regulation 32 – Personal life-saving appliances	24
Regulation 33 – Survival craft embarkation and launching arrangements	25
Regulation 34 – Application of the LSA-Code.....	25
Regulation 35 – Training manual and on-board training aids	25
Regulation 36 – Instructions for on-board maintenance.....	26
Regulation 37 – Muster list and emergency instructions.....	26
Regulation 38 – Alternative design and arrangements	27

Part B – Requirements for ships and life-saving appliances

Section I – Passenger ships and cargo ships

Regulation 6 – Communications

1. Paragraph 2 applies to all passenger ships and to all cargo ships of 300 gross tonnage and upwards. *Paragraph 2 shall also apply to cargo ships with a gross tonnage below 300, but with a length of 15 m or more or with a scantling number of 100 or more.*

2. Radio life-saving appliances

2.1. “Two-way VHF radiotelephone apparatus”

^{2.1.1.} At least 3 two-way VHF radiotelephone apparatus shall be provided on every passenger ship and on every cargo ship of 500 gross tonnage and upwards. At least 2 two-way VHF radiotelephone apparatus shall be provided on every cargo ship less than 500 gross tonnage. *In cargo ships engaged in domestic trade, at least one two-way VHF apparatus shall be provided.* Such apparatus shall conform to performance standards not inferior to those adopted by the Organization. If a fixed two-way VHF radiotelephone apparatus is fitted in a survival craft it shall conform to performance standards not inferior to those adopted by the Organization.¹

2.2. Search and rescue locating devices

At least one search and rescue locating device shall be carried on each side of every passenger ship and of every cargo ship of 500 gross tonnage and upwards. At least one search and rescue locating device shall be carried on every cargo ship of less than 500 gross tonnage. Such search and rescue locating devices shall conform to the applicable performance standards not inferior to those adopted by the Organization². The search and rescue locating devices³ shall be stowed in such location that they can be rapidly placed in any survival craft other than the liferaft or liferafts required by regulation 31.1.4. Alternatively one search and rescue locating device shall be stowed in each survival craft other than those required by regulation 31.1.4. On ships carrying at least two search and rescue locating devices and equipped with free-fall lifeboats one of the search and rescue locating devices shall be stowed in a free-fall lifeboat and the other located in the immediate vicinity of the navigation bridge so that it can be utilized on board and ready for transfer to any of the other survival craft.

3. Distress flares

Not less than 12 rocket parachute flares, complying with the requirements of section 3.1 of the Code, shall be carried and be stowed on or near the navigation bridge in a place where they are protected against humidity.

4. On-board communications and alarm systems

4.1. An emergency means comprised of either fixed or portable equipment or both shall be provided for two-way communications between emergency control stations, muster and embarkation stations and strategic positions on board.

4.2. A general emergency alarm system complying with the requirements of paragraph 7.2.1 of the Code shall be provided and shall be used for summoning passengers and crew to

¹ Refer to Performance standards for survival craft two-way VHF radiotelephone apparatus adopted by the Organization by resolution A.809(19), as it may be amended, annex 1 or annex 2 as applicable.

² Refer to Performance standards for survival craft radar transponders for use in search and rescue operations, adopted by the Organization by resolution A.802(19), as amended.

³ One of these search and rescue locating devices may be the search and rescue locating device required by regulation IV/7.1.3.

muster stations and to initiate the actions included in the muster list. The system shall be supplemented by either a public address system complying with the requirements of paragraph 7.2.2 of the Code or other suitable means of communication. Entertainment sound systems shall automatically be turned off when the general emergency alarm system is activated.

- 4.3. The general emergency system must be audible throughout the accommodation and on locations where the crew under usual conditions are working. On passenger ships the general emergency alarm system shall be audible on all open decks.
- 4.4. On ships fitted with a marine evacuation system communication between the embarkation station and the platform or the survival craft shall be ensured.

5. Public address systems on passenger ships

- 5.1. In addition to the requirements of regulation II-2/40.5 or regulation II-2/41-2⁴, as appropriate, and of paragraph 4.2, all passenger ships shall be fitted with a public address system. With respect to passenger ships constructed before 1 July 1997 the requirements of paragraphs 5.2 and 5.4, subject to the provisions of paragraph 5.5, shall apply not later than the date of the first periodical survey after 1 July 1997.
- 5.2. The public address system shall be clearly audible above the ambient noise in all spaces, prescribed by paragraph 7.2.2.1 of the Code, and shall be provided with an override function controlled from one location on the navigation bridge and such other places on board as the Administration deems necessary, so that all emergency messages will be broadcast if any loudspeaker in the spaces concerned has been switched off, its volume has been turned down or the public address system is used for other purposes.
- 5.3. On passenger ships constructed on or after 1 July 1997:
 - 5.3.1. the public address system shall have at least two loops which shall be sufficiently separated throughout their length and have two separate and independent amplifiers; and
 - 5.3.2. the public address system and its performance standards shall be approved by the Administration having regard to the recommendations adopted by the Organization⁵.
- 5.4. The public address system shall be connected to the emergency source of electrical power required by regulation II-1/42.2.2.
- 5.5. Ships constructed before 1 July 1997 which are already fitted with the public address system approved by the Administration which complies substantially with those required by sections 5.2 and 5.4 and paragraph 7.2.2.1 of the Code are not required to change their system.

Regulation 7 – Personal life-saving appliances

1. Lifebuoys

- 1.1. Lifebuoys complying with the requirements of paragraph 2.1.1 of the Code shall be:
 - 1.1.1. so distributed as to be readily available on both sides of the ship and as far as practicable on all open decks extending to the ship's side; at least one shall be placed in the vicinity of the stern; and
 - 1.1.2. so stowed as to be capable of being rapidly cast loose, and not permanently secured in any way.

⁴ These relate to the chapter II-2 in force before 1 July 2002. The equivalent for each in the amended chapter II-2 is 12.3.

⁵ Refer to MSC/Circ.808, Recommendation on performance standards for public address systems on passenger ships, including cabling.

- 1.2. At least one lifebuoy on each side of the ship shall be fitted with a buoyant lifeline complying with the requirements of paragraph 2.1.4 of the Code equal in length to not less than twice the height at which it is stowed above the waterline in the lightest seagoing condition, or 30 m, whichever is the greater.
- 1.3. Not less than one half of the total number of lifebuoys shall be provided with lifebuoy self-igniting lights complying with the requirements of paragraph 2.1.2 of the Code; not less than two of these shall also be provided with lifebuoy self-activating smoke signals complying with the requirements of paragraph 2.1.3 of the Code and be capable of quick release from the navigation bridge; lifebuoys with lights and those with lights and smoke signals shall be equally distributed on both sides of the ship and shall not be the lifebuoys provided with lifelines in compliance with the requirements of paragraph 1.2.
- 1.4. Each lifebuoy shall be marked in block capitals of the Roman alphabet with the name and port of registry of the ship on which it is carried.

2. Lifejackets

- 2.1. A lifejacket complying with the requirements of paragraph 2.2.1 or 2.2.2 of the Code shall be provided for every person on board the ship and, in addition:
 - 2.1.1. for passenger ships on voyages less than 24 h, a number of infant lifejackets equal to at least 2.5% of the number of passengers on board shall be provided;
 - 2.1.2. for passenger ships on voyages 24 h or greater, infant lifejackets shall be provided for each infant on board;
 - 2.1.3. a number of lifejackets suitable for children equal to at least 10% of the number of passengers on board shall be provided or such greater number as may be required to provide a lifejacket for each child;
 - 2.1.4. a sufficient number of lifejackets shall be carried for persons on watch and for use at remotely located survival craft stations. The lifejackets carried for persons on watch should be stowed on the bridge, in the engine control room and at any other manned watch station; and
 - 2.1.5. if the adult lifejackets provided are not designed to fit persons weighing up to 140 kg and with a chest girth of up to 1,750 mm, a sufficient number of suitable accessories shall be available on board to allow them to be secured to such persons.
- 2.2. Lifejackets shall be so placed as to be readily accessible and their position shall be plainly indicated. Where, due to the particular arrangements of the ship, the lifejackets provided in compliance with the requirements of paragraph 2.1 may become inaccessible, alternative provisions shall be made to the satisfaction of the Administration which may include an increase in the number of lifejackets to be carried.
- 2.3. The lifejackets used in totally enclosed lifeboats, except free-fall lifeboats, shall not impede entry into the lifeboat or seating, including operation of the seat belts in the lifeboat.
- 2.4. Lifejackets selected for free-fall lifeboats, and the manner in which they are carried or worn, shall not interfere with entry into the lifeboat, occupant safety or operation of the lifeboat.

3. Immersion suits and anti-exposure suits

- 3.1. An immersion suit, complying with the requirements of section 2.3 of the Code or an anti-exposure suit complying with section 2.4 of the Code, of an appropriate size, shall be provided for every person assigned to crew the rescue boat or assigned to the marine

evacuation system party. If the ship is constantly engaged in warm climates⁶ where, in the opinion of the Administration thermal protection is unnecessary, this protective clothing need not be carried.

Regulation 8 – Muster list and emergency instructions

1. This regulation applies to all ships.
2. Clear instructions to be followed in the event of an emergency shall be provided for every person on board. In the case of passenger ships these instructions shall be drawn up in the language or languages required by the ship's flag State and in the English language.
3. Muster lists and emergency instructions complying with the requirements of regulation 37 shall be exhibited in conspicuous places throughout the ship including the navigation bridge, engine-room and crew accommodation spaces.
4. Illustrations and instructions in appropriate languages shall be posted in passenger cabins and be conspicuously displayed at muster stations and other passenger spaces to inform passengers of:
 - 4.1. their muster station;
 - 4.2. the essential actions they must take in an emergency; and
 - 4.3. the method of donning lifejackets.

Regulation 9 – Operating instructions

1. This regulation applies to all ships.
2. Posters or signs shall be provided on or in the vicinity of survival craft and their launching controls and shall:
 - 2.1. illustrate the purpose of controls and the procedures for operating the appliance and give relevant instructions or warnings;
 - 2.2. be easily seen under emergency lighting conditions; and
 - 2.3. use symbols in accordance with the recommendations of the Organization⁷.

Regulation 10 – Manning of survival craft and supervision

1. This regulation applies to all ships.
2. There shall be a sufficient number of trained persons on board for mustering and assisting untrained persons.
3. There shall be a sufficient number of crew members, who may be deck officers or certificated persons, on board for operating the survival craft and launching arrangements required for abandonment by the total number of persons on board.
4. A deck officer or certificated person shall be placed in charge of each survival craft to be used. However, the Administration, having due regard to the nature of the voyage, the number of persons on board and the characteristics of the ship, may permit persons practised in the handling and operation of liferafts to be placed in charge of liferafts in lieu of persons qualified as above. A second-in-command shall also be nominated in the case of lifeboats.
5. The person in charge of the survival craft shall have a list of the survival craft crew and shall see that the crew under his command are acquainted with their duties. In lifeboats the second-in-command shall also have a list of the lifeboat crew.
6. Every motorized survival craft shall have a person assigned who is capable of operating the engine and carrying out minor adjustments.

⁶ Refer to MSC/Circ.1046, Guidelines for assessment of thermal protection.

⁷ Refer to Symbols related to life-saving appliances and arrangements adopted by the Organization by resolution A.760(18), as amended by resolution MSC.82(70).

7. The master shall ensure the equitable distribution of persons referred to in paragraphs 2, 3 and 4 among the ship's survival craft.

Regulation 11 – Survival craft muster and embarkation arrangements

1. Lifeboats and liferafts for which approved launching appliances are required shall be stowed as close to accommodation and service spaces as possible.
2. Muster stations shall be provided close to the embarkation stations. Each muster station shall have sufficient clear deck space to accommodate all persons assigned to muster at that station, but at least 0.35 m² per person.
3. Muster and embarkation stations shall be readily accessible from accommodation and work areas.
4. Muster and embarkation stations shall be adequately illuminated by lighting supplied from the emergency source of electrical power required by regulation II-1/42 or II-1/43, as appropriate.
5. Alleyways, stairways and exits giving access to the muster and embarkation stations shall be lighted. Such lighting shall be capable of being supplied by the emergency source of electrical power required by regulation II-1/42 or II-1/43, as appropriate. In addition to and as part of the markings required under regulation II-2/28.1.10⁸, routes to muster stations shall be indicated with the muster station symbol, intended for that purpose, in accordance with the recommendations of the Organization.⁹
6. Davit-launched and free-fall launched survival craft muster and embarkation stations shall be so arranged as to enable stretcher cases to be placed in survival craft.
7. An embarkation ladder complying with the requirements of paragraph 6.1.6 of the Code extending, in a single length, from the deck to the waterline in the lightest seagoing condition under all conditions of trim of up to 10° and a list of up to 20° either way shall be provided at each embarkation station or at every two adjacent embarkation stations for survival craft launched down the side of the ship. However, the Administration may permit such ladders to be replaced by approved devices to afford access to the survival craft when waterborne, provided that there shall be at least one embarkation ladder on each side of the ship. Other means of embarkation enabling descent to the water in a controlled manner may be permitted for the liferafts required by regulation 31.1.4.
8. Where necessary, means shall be provided for bringing the davit-launched survival craft against the ship's side and holding them alongside so that persons can be safely embarked.

Regulation 12 – Launching stations

Launching stations shall be in such positions as to ensure safe launching having particular regard to clearance from the propeller and steeply overhanging portions of the hull and so that, as far as possible, survival craft, except survival craft specially designed for free-fall launching, can be launched down the straight side of the ship. If positioned forward, they shall be located abaft the collision bulkhead in a sheltered position and; in this respect the Administration shall give special consideration to the strength of the launching appliance.

Regulation 13 – Stowage of survival craft

1. Each survival craft shall be stowed:

⁸ This relates to the chapter II-2 in force before 1 July 2002. The equivalent for each in the amended chapter II-2 is 13.3.2.5.1.

⁹ Refer to Symbols related to life-saving appliances and arrangements adopted by the Organization by resolution A.760(18), as amended by resolution MSC.82(70), and to the Guidelines for the evaluation, testing and application of low-location lighting on passenger ships adopted by the Organization by resolution A.752(18).

- 1.1. so that neither the survival craft nor its stowage arrangements will interfere with the operation of any other survival craft or rescue boat at any other launching station;
- 1.2. as near the water surface as is safe and practicable and, in the case of a survival craft other than a liferaft intended for throw over board launching, in such a position that the survival craft in the embarkation position is not less than 2 m above the waterline with the ship in the fully loaded condition under unfavourable conditions of trim of up to 10° and listed up to 20° either way, or to the angle at which the ship's weather deck edge becomes submerged, whichever is less;
- 1.3. in a state of continuous readiness so that two crew members can carry out preparations for embarkation and launching in less than 5 min;
- 1.4. fully equipped as required by this chapter and the Code; and
- 1.5. as far as practicable, in a secure and sheltered position and protected from damage by fire and explosion. In particular, survival craft on tankers, other than the liferafts required by regulation 31.1.4, shall not be stowed on or above a cargo tank, slop tank, or other tank containing explosive or hazardous cargoes.
2. Lifeboats for lowering down the ship's side shall be stowed as far forward of the propeller as practicable. On cargo ships of 80 m in length and upwards but less than 120 m in length, each lifeboat shall be so stowed that the after end of the lifeboat is not less than the length of the lifeboat forward of the propeller. On cargo ships of 120 m in length and upwards and passenger ships of 80 m in length and upwards, each lifeboat shall be so stowed that the after end of the lifeboat is not less than 1.5 times the length of the lifeboat forward of the propeller. Where appropriate, the ship shall be so arranged that lifeboats, in their stowed positions, are protected from damage by heavy seas.
3. Lifeboats shall be stowed attached to launching appliances.
4.
 - 4.1. Every liferaft shall be stowed with its painter permanently attached to the ship.
 - 4.2. Each liferaft or group of liferafts shall be stowed with a float-free arrangement complying with the requirements of paragraph 4.1.6 of the Code so that each floats free and, if inflatable, inflates automatically when the ship sinks.
 - 4.3. Liferafts shall be so stowed as to permit manual release of one raft or container at a time from their securing arrangements.
 - 4.4. Paragraphs 4.1 and 4.2 do not apply to liferafts required by regulation 31.1.4.
5. Davit-launched liferafts shall be stowed within reach of the lifting hooks, unless some means of transfer is provided which is not rendered inoperable within the limits of trim and list prescribed in paragraph 1.2 or by ship motion or power failure.
6. Liferafts intended for throw-overboard launching shall be so stowed as to be readily transferable for launching on either side of the ship unless liferafts, of the aggregate capacity required by regulation 31.1 to be capable of being launched on either side, are stowed on each side of the ship.

Regulation 14 – Stowage of rescue boats

Rescue boats shall be stowed:

- 1.1. in a state of continuous readiness for launching in not more than 5 min and if it is of an inflatable type it must be kept fully inflated;
- 1.2. in a position suitable for launching and recovery;
- 1.3. so that neither the rescue boat nor its stowage arrangements will interfere with the operation of any survival craft at any other launching station; and
- 1.4. if it is also a lifeboat, in compliance with the requirements of regulation 13.

Regulation 15 – Stowage of marine evacuation systems

1. The ship's side shall not have any openings between the embarkation station of the marine evacuation system and the waterline in the lightest seagoing condition and means shall be provided to protect the system from any projections.
2. Marine evacuation systems shall be in such positions as to ensure safe launching having particular regard to clearance from the propeller and steeply overhanging positions of the hull and so that, as far as practicable, the system can be launched down the straight side of the ship.
3. Each marine evacuation system shall be stowed so that neither the passage nor platform nor its stowage or operational arrangements will interfere with the operation of any other life-saving appliance at any other launching station.
4. Where appropriate, the ship shall be so arranged that the marine evacuation systems in their stowed positions are protected from damage by heavy seas.

Regulation 16 – Survival craft launching and recovery arrangements

1. Unless expressly provided otherwise, launching and embarkation appliances complying with the requirements of section 6.1 of the Code shall be provided for all survival craft except those which are:
 - 1.1. boarded from a position on deck less than 4.5 m above the waterline in the lightest seagoing condition and which have a mass of not more than 185 kg; or
 - 1.2. boarded from a position on deck less than 4.5 m above the waterline in the lightest seagoing condition and which are stowed for launching directly from the stowed position under unfavourable conditions of trim of up to 10° and list of up to 20° either way; or
 - 1.3. carried in excess of the survival craft for 200% of the total number of persons on board the ship and which have a mass of not more than 185 kg; or
 - 1.4. carried in excess of the survival craft for 200% of the total number of persons on board the ship, are stowed for launching directly from the stowed position under unfavourable conditions of trim of up to 10° and list of up to 20° either way; or
 - 1.5. provided for use in conjunction with a marine evacuation system, complying with the requirements of section 6.2 of the Code and stowed for launching directly from the stowed position under unfavourable conditions of trim of up to 10° and list of up to 20° either way.
2. Each lifeboat shall be provided with an appliance which is capable of launching and recovering the lifeboat. In addition there shall be provision for hanging off the lifeboat to free the release gear for maintenance.
3. Launching and recovery arrangements shall be such that the appliance operator on the ship is able to observe the survival craft at all times during launching and for lifeboats *and rescue boats* during recovery.
4. Only one type of release mechanism shall be used for similar survival craft carried on board the ship.
5. Preparation and handling of survival craft at any one launching station shall not interfere with the prompt preparation and handling of any other survival craft or rescue boat at any other station.
6. Falls, where used, shall be long enough for the survival craft to reach the water with the ship in its lightest seagoing condition, under unfavourable conditions of trim of up to 10° and list of up to 20° either way.
7. During preparation and launching, the survival craft, its launching appliance, and the area of water into which it is to be launched shall be adequately illuminated by lighting supplied from the emergency source of electrical power required by regulation II-1/42 or II-1/43, as appropriate.

8. Means shall be available to prevent any discharge of water onto survival craft during abandonment.
9. If there is a danger of the survival craft being damaged by the ship's stabilizer wings, means shall be available, powered by an emergency source of energy, to bring the stabilizer wings inboard; indicators operated by an emergency source of energy shall be available on the navigating bridge to show the position of the stabilizer wings.
10. If partially enclosed lifeboats complying with the requirements of section 4.5 of the Code are carried, a davit span shall be provided, fitted with not less than two lifelines of sufficient length to reach the water with the ship in its lightest seagoing condition, under unfavourable conditions of trim of up to 10° and list of up to 20° either way.

Regulation 17 – Rescue boat embarkation, launching and recovery arrangements

1. The rescue boat embarkation and launching arrangements shall be such that the rescue boat can be boarded and launched in the shortest possible time.
2. If the rescue boat is one of the ship's survival craft, the embarkation arrangements and launching station shall comply with the requirements of regulations 11 and 12.
3. Launching arrangements shall comply with the requirements of regulation 16. However, all rescue boats shall be capable of being launched, where necessary utilizing painters, with the ship making headway at speeds up to 5 knots in calm water.
4. Recovery time of the rescue boat shall be not more than 5 min in moderate sea conditions when loaded with its full complement of persons and equipment. If the rescue boat is also a lifeboat, this recovery time shall be possible when loaded with its lifeboat equipment and the approved rescue boat complement of at least six persons.
5. Rescue boat embarkation and recovery arrangements shall allow for safe and efficient handling of a stretcher case. Foul weather recovery strops shall be provided for safety if heavy fall blocks constitute a danger.

Regulation 18 – Line-throwing appliances

A line-throwing appliance complying with the requirements of section 7.1 of the Code shall be provided. *Ships with a gross tonnage below 250 shall not be required to carry line-throwing appliances.*

Regulation 19 – Emergency training and drills

1. This regulation applies to all ships.
2. **Familiarity with safety installations and practice musters**
 - 2.1. Every crew member with assigned emergency duties shall be familiar with these duties before the voyage begins.
 - 2.2. On a ship engaged on a voyage where passengers are scheduled to be on board for more than 24 h, musters of the passengers shall take place within 24h after their embarkation. Passengers shall be instructed in the use of the lifejackets and the action to take in an emergency.
 - 2.3. Whenever new passengers embark, a passenger safety briefing shall be given immediately before sailing, or immediately after sailing. The briefing shall include the instructions required by regulations 8.2 and 8.4, and shall be made by means of an announcement, in one or more languages likely to be understood by the passengers. The announcement shall be made on the ship's public address system, or by other equivalent means likely to be heard at least by the passengers who have not yet heard it during the voyage. The briefing may be included in the muster required by paragraph 2.2 if the muster is held immediately

upon departure. Information cards or posters or video programmes displayed on ships video displays may be used to supplement the briefing, but may not be used to replace the announcement.

3. Drills

3.1. Drills shall, as far as practicable, be conducted as if there were an actual emergency.

3.2. Every crew member shall participate in at least one abandon ship drill and one fire drill every month. The drills of the crew shall take place within 24 h of the ship leaving a port if more than 25% of the crew have not participated in abandon ship and fire drills on board that particular ship in the previous month. When a ship enters service for the first time, after modification of a major character or when a new crew is engaged, these drills shall be held before sailing. The Administration may accept other arrangements that are at least equivalent for those classes of ships for which this is impracticable.

3.3. "Abandon ship drill"

3.3.1. Each abandon ship drill shall include:

3.3.1.1. summoning of passengers and crew to muster stations with the alarm required by regulation 6.4.2 followed by drill announcement on the public address or other communication system and ensuring that they are made aware of the order to abandon ship;

3.3.1.2. reporting to stations and preparing for the duties described in the muster list;

3.3.1.3. checking that passengers and crew are suitably dressed;

3.3.1.4. checking that lifejackets are correctly donned;

3.3.1.5. lowering of at least one lifeboat after any necessary preparation for launching;

3.3.1.6. starting and operating the lifeboat engine;

3.3.1.7. operation of davits used for launching liferafts;

3.3.1.8. a mock search and rescue of passengers trapped in their staterooms; and

3.3.1.9. instruction in the use of radio lifesaving appliances.

3.3.2. Different lifeboats shall, as far as practicable, be lowered in compliance with the requirements of paragraph 3.3.1.5 at successive drills.

3.3.3. Except as provided in paragraphs 3.3.4 and 3.3.5, each lifeboat shall be launched and manoeuvred in the water by its assigned operating crew at least once every three months during an abandon ship drill.

3.3.4. In the case of a lifeboat arranged for free-fall launching, at least once every three months during an abandon ship drill the crew shall board the lifeboat, properly secure themselves in their seats and commence launch procedures up to but not including the actual release of the lifeboat (i.e., the release hook shall not be released). The lifeboat shall then either be free-fall launched with only the required operating crew on board, or lowered into the water by means of the secondary means of launching with or without the operating crew on board. In both cases the lifeboat shall thereafter be manoeuvred in the water by the operating crew. At intervals of not more than six months, the lifeboat shall either be launched by free-fall with only the operating crew on board, or simulated launching shall be carried out in accordance with the guidelines developed by the Organization.¹⁰

¹⁰ Refer to the relevant parts of MSC.1/Circ. 1206 Measures to prevent accidents with lifeboats.

- 3.3.5. The Administration may allow ships operating on short international voyages not to launch the lifeboats on one side if their berthing arrangements in port and their trading patterns do not permit launching of lifeboats on that side. However, all such lifeboats shall be lowered at least once every three months and launched at least annually.
- 3.3.6. As far as is reasonable and practicable, rescue boats other than lifeboats which are also rescue boats, shall be launched each month with their assigned crew aboard and manoeuvred in the water. In all cases this requirement shall be complied with at least once every three months.
- 3.3.7. If lifeboat and rescue boat launching drills are carried out with the ship making headway, such drills shall, because of the dangers involved, be practised in sheltered waters only and under the supervision of an officer experienced in such drills¹¹.
- 3.3.8. If a ship is fitted with marine evacuation systems, drills shall include exercising of the procedures required for the deployment of such a system up to the point immediately preceding actual deployment of the system. This aspect of drills should be augmented by regular instruction using the on-board training aids required by regulation 35.4. Additionally every system party member shall, as far as practicable, be further trained by participation in a full deployment of a similar system into water, either on board a ship or ashore, at intervals of not longer than two years, but in no case longer than three years. This training can be associated with the deployments required by regulation 20.8.2.
- 3.3.9. Emergency lighting for mustering and abandonment shall be tested at each abandon ship drill.

3.4. "Fire drills"

- 3.4.1. Fire drills should be planned in such a way that due consideration is given to regular practice in the various emergencies that may occur depending on the type of ships and the cargo.
- 3.4.2. Each fire drill shall include:
 - 3.4.2.1. reporting to stations and preparing for the duties described in the muster list required by regulation 8;
 - 3.4.2.2. starting of a fire pump, using at least the two required jets of water to show that the system is in proper working order;
 - 3.4.2.3. checking of fireman's outfit and other personal rescue equipment;
 - 3.4.2.4. checking of relevant communication equipment;
 - 3.4.2.5. checking the operation of watertight doors, fire doors, fire dampers and main inlets and outlets of ventilation systems in the drill area; and
 - 3.4.2.6. checking the necessary arrangements for subsequent abandoning of the ship.
- 3.4.3. The equipment used during drills shall immediately be brought back to its fully operational condition and any faults and defects discovered during the drills shall be remedied as soon as possible.

4. On-board training and instructions

- 4.1. On-board training in the use of the ship's life-saving appliances, including survival craft equipment, and in the use of the ship's fire-extinguishing appliances shall be given as soon as possible but not later than two weeks after a crew member joins the ship. However, if

¹¹ Refer to the Guidelines on training for the purpose of launching lifeboats and rescue boats from ships making headway through the water adopted by the Organization by resolution A.624(15).

the crew member is on a regularly scheduled rotating assignment to the ship, such training shall be given not later than two weeks after the time of first joining the ship. Instructions in the use of the ship's fire-extinguishing appliances, life-saving appliances, and in survival at sea shall be given at the same interval as the drills. Individual instruction may cover different parts of the ship's life-saving and fire-extinguishing appliances, but all the ship's life-saving and fire-extinguishing appliances shall be covered within any period of two months.

- 4.2. Every crew member shall be given instructions which shall include but not necessarily be limited to:
 - 4.2.1. operation and use of the ship's inflatable liferafts;
 - 4.2.2. problems of hypothermia, first-aid treatment for hypothermia and other appropriate first-aid procedures;
 - 4.2.3. special instructions necessary for use of the ship's life-saving appliances in severe weather and severe sea conditions; and
 - 4.2.4. operation and use of fire-extinguishing appliances.
- 4.3. On-board training in the use of davit-launched liferafts shall take place at intervals of not more than four months on every ship fitted with such appliances. Whenever practicable this shall include the inflation and lowering of a liferaft. This liferaft may be a special liferaft intended for training purposes only, which is not part of the ship's life-saving equipment; such a special liferaft shall be conspicuously marked.

5. Records

The date when musters are held, details of abandon ship drills and fire drills, drills of other life-saving appliances and on board training shall be recorded in *the Annex File or in the Instructions for the maintenance of life-saving appliances*. If a full muster, drill or training session is not held at the appointed time, an entry shall be made in the *Annex File* stating the circumstances and the extent of the muster, drill or training session held.

Regulation 20 – Operational readiness, maintenance and inspections

1. This regulation applies to all ships. The requirements of paragraphs 3.2, 3.3 and 6.2 shall be complied with, as far as is practicable, on ships constructed before 1 July 1986.
2. **Operational readiness**
Before the ship leaves port and at all times during the voyage, all life-saving appliances shall be in working order and ready for immediate use.
3. **Maintenance**
 - 3.1. Maintenance, testing and inspections of life saving appliances shall be carried out based on the guidelines developed by the Organisation¹² and in a manner having due regard to ensuring reliability of such appliances.
 - 3.2. Instructions for on-board maintenance of life-saving appliances complying with regulation 36 shall be provided and maintenance shall be carried out accordingly.
 - 3.3. The Administration may accept, in compliance with the requirements of paragraph 3.2, a shipboard planned maintenance programme, which includes the requirements of regulation 36.
4. **Maintenance of falls**
Falls used in launching shall be inspected periodically¹³ with special regard for areas passing through sheaves, and renewed when necessary due to deterioration of the falls or at intervals of

¹² Refer to MSC/Circ. 1093, Guidelines for periodic servicing and maintenance of lifeboats, launching appliances and on-load release gear.

¹³ Refer to the relevant parts of MSC.1/Circ. 1206 Measures to prevent accidents with lifeboats.

not more than 5 years, whichever is the earlier. *With regard to stainless steel falls, it is permitted that wire of AISI 316 quality or better provided with steel cores are replaced after no more than 15 years from the date stated on the wire certificate. The wire shall be turned end for end or displaced lengthwise at intervals not exceeding 30 months in order that a “new” piece of wire will lie over blocks and sheaves. The lifetime of taleroid splices may not exceed 5 years. If inspection reveals mechanical damage, corrosion or other defects, the wire shall be replaced immediate.*

5. Spares and repair equipment

Spares and repair equipment shall be provided for lifesaving appliances and their components which are subject to excessive wear or consumption and need to be replaced regularly.

6. Weekly inspection

The following tests and inspections shall be carried out weekly and a report of the inspection shall be entered in the log-book:

- 6.1. all survival craft, rescue boats and launching appliances shall be visually inspected to ensure that they are ready for use. The inspection shall include, but is not limited to, the condition of hooks, their attachment to the lifeboat and the on-load gear being properly and completely reset;
- 6.2. all engines in lifeboats and rescue boats shall be run for a total period of not less than 3 min, provided the ambient temperature is above the minimum temperature required for starting and running the engine. During this period of time, it should be demonstrated that the gear box and gear box train are engaging satisfactorily. If the special characteristics of an outboard motor fitted to a rescue boat would not allow it to be run other than with its propeller submerged for a period of 3 min, a suitable water supply may be supplied. In special cases the Administration may waive this requirement for ships constructed before 1 July 1986;
- 6.3. Lifeboats, except free-fall lifeboats, on cargo ships shall be moved from their stowed position without any persons on board, to the extent necessary to demonstrate satisfactory operation of launching appliances, if weather and sea conditions so allow; and
- 6.4. the general emergency alarm shall be tested.

7. Monthly inspections

- 7.1. All lifeboats, except freefall lifeboats, shall be turned out from their stowed position, without any persons on board if weather and sea conditions so allow.
- 7.2. Inspection of the life-saving appliances, including lifeboat equipment, shall be carried out monthly using the checklist required by regulation 36.1 to ensure that they are complete and in good order. A report of the inspection shall be entered in the *Annex File or in the Instructions for the maintenance of life-saving appliances.*

8. Servicing of inflatable liferafts, inflatable lifejackets, marine evacuation systems and maintenance and repair of inflated rescue boats¹⁴

- 8.1. Every inflatable liferaft, inflatable lifejacket, and marine evacuation system shall be serviced:
 - 8.1.1. at intervals not exceeding 12 months, provided where in any case this is impracticable, the Administration may extend this period to 17 months; and

¹⁴ For ships applicable to the Harmonized system for survey and certification (HSSC), the service intervals for inflatable liferafts, inflatable lifejackets, marine evacuation systems (MES), inflatable rescue boats, hydrostatic release gear and satellite EPIRBs can follow the intervals for annual-, periodic- and renewal survey as described in the 1988 SOLAS protocol regardless of the requirements in regulation III/20.8, III/20/9 and IV/15.9 in the 1974 SOLAS Convention with later amendments, cf. IMO MSC.Circ.955 of 23 June 2000.

- 8.1.2. at an approved servicing station which is competent to service them, maintains proper servicing facilities and uses only properly trained personnel;¹⁵
- 8.1.3. *documentation of the latest inspection shall be kept on board;*
- 8.1.4. *in Denmark and in Greenland, inspections may be carried out only by persons or service stations also approved by the Danish Maritime Authority.*

8.2. Rotational deployment of marine evacuation systems

In addition to or in conjunction with the servicing intervals of marine evacuation systems required by paragraph 8.1, each marine evacuation system should be deployed from the ship on a rotational basis at intervals to be agreed by the Administration provided that each system is to be deployed at least once every six years.

- 8.3. An Administration which approves new and novel inflatable liferaft arrangements pursuant to regulation 4 may allow for extended service intervals on the following conditions:
 - 8.3.1. the new and novel liferaft arrangement has proved to maintain the same standard, as required by testing procedure, during extended service intervals.
 - 8.3.2. The liferaft system shall be checked on board by certified personnel according to paragraph 8.1.1.
 - 8.3.3. Service at intervals not exceeding five years shall be carried out in accordance with the recommendations of the Organization¹⁶.
- 8.4. All repairs and maintenance of inflated rescue boats shall be carried out in accordance with the manufacturer's instructions. Emergency repairs may be carried out on board the ship; however, permanent repairs shall be effected at an approved servicing station.
- 8.5. An Administration which permits extension of liferaft service intervals in accordance with paragraph 8.3 shall notify the Organization of such action in accordance with regulation I/5(b).

9. Periodic servicing of hydrostatic release units

Hydrostatic release units, other than disposable hydrostatic release units, shall be serviced:

- 9.1. at intervals not exceeding 12 months, provided where in any case this is impracticable, the Administration may extend this period to 17 months¹⁷;
- 9.2. at a servicing station which is competent to service them, maintains proper servicing facilities and uses only properly trained personnel;
- 9.3. *documentation of the latest inspection shall be kept on board; and*
- 9.4. *in Denmark and Greenland, inspections may be carried out only by persons or service stations also approved by the Danish Maritime Authority.*

10. Marking of stowage locations

Containers, brackets, racks, and other similar stowage locations for life-saving equipment shall be marked with symbols in accordance with the recommendations of the Organization¹⁸, indicating the devices stowed in that location for that purpose. If more than one device is stowed in that location, the number of devices shall also be indicated.

11. Periodic servicing of launching appliances and onload release gear

- 11.1. Launching appliances shall be:

¹⁵ Refer to the Recommendation on conditions for the approval of servicing stations for inflatable liferafts adopted by the Organization by resolution A.761(18) and amended by resolution MSC.55(66).

¹⁶ Refer to "Recommendation on conditions for the approval of servicing stations for inflatable liferafts", adopted by the IMO by resolution A.761(18), as amended by MSC.55(66).

¹⁷ Refer to MSC/Circ. 955, Servicing of life-saving appliances and radio communication equipment under the harmonized system of survey and certification (HSSC).

¹⁸ Refer to the Symbols related to life-saving appliances and arrangements adopted by the Organization by resolution A.760(18) and resolution MSC.82(70).

- 11.1.1. maintained in accordance with instructions for on-board maintenance as required by regulation 36;
 - 11.1.2. subject to a thorough examination at the annual surveys required by regulation I/7 or I/8, as applicable; and
 - 11.1.3. upon completion of the examination referred to in .2 subjected to a dynamic test of the winch brake at maximum lowering speed. The load to be applied shall be the mass of the survival craft or rescue boat without persons on board, except that, at intervals not exceeding five years, the test shall be carried out with a proof load equal to 1.1 times the weight of the survival craft or rescue boat and its full complement of persons and equipment. *At least every five years, the test shall, however, be carried out with a test load of 1.1 times the maximum work load of the winch.*
- 11.2. Lifeboat or rescue boat on-load release gear, including free-fall lifeboat release systems, shall be:
- 11.2.1. maintained in accordance with instructions for on board maintenance as required by regulation 36;
 - 11.2.2. subject to a thorough examination and operational test during the annual surveys required by regulations I/7 and I/8 by properly trained personnel familiar with the system; and
 - 11.2.3. operationally tested under a load of 1.1 times the total mass of the boat when loaded with its full complement of persons and equipment whenever the release gear is overhauled. Such overhauling and test shall be carried out at least once every five years¹⁹.
- 11.3. Davit-launched liferaft automatic release hooks shall be:
- 11.3.1. maintained in accordance with instructions for on-board maintenance as required by regulation 36
 - 11.3.2. subject to a thorough examination and operational test during the annual surveys required by regulations I/7 and I/8 by properly trained personnel familiar with the system; and
 - 11.3.3. operationally tested under a load of 1.1 times the total mass of the liferaft when loaded with its full complement of persons and equipment whenever the automatic release hook is overhauled. Such over-hauling and test shall be carried out at least once every five years.²⁰

Section II – Passenger ships (Additional requirements)

Regulation 21 – Survival craft and rescue boats

1. Survival craft

¹⁹ Refer to the Recommendation on testing of life-saving appliances adopted by the Organization by resolution A.689(17). For life-saving appliances installed on board on or after 1 July 1999, refer to the Revised Recommendations on testing of life-saving appliances adopted by the Maritime Safety Committee of the Organization by resolution MSC.81(70).

²⁰ Refer to the Recommendation on testing of life-saving appliances adopted by the Organization by resolution A.689(17). For life-saving appliances installed on board on or after 1 July 1999, refer to the Revised Recommendations on testing of life-saving appliances adopted by the Maritime Safety Committee of the Organization by resolution MSC.81(70).

- 1.1. Passenger ships engaged on international voyages which are not short international voyages shall carry:
 - 1.1.1. partially or totally enclosed lifeboats complying with the requirements of section 4.5 or 4.6 of the Code on each side of such aggregate capacity as will accommodate not less than 50% of the total number of persons on board. The Administration may permit the substitution of lifeboats by liferafts of equivalent total capacity provided that there shall never be less than sufficient lifeboats on each side of the ship to accommodate 37.5% of the total number of persons on board. The inflatable or rigid liferafts shall comply with the requirements of section 4.2 or 4.3 of the Code and shall be served by launching appliances equally distributed on each side of the ship; and
 - 1.1.2. in addition, inflatable or rigid liferafts complying with the requirements of section 4.2 or 4.3 of the Code of such aggregate capacity as will accommodate at least 25% of the total number of persons on board. These liferafts shall be served by at least one launching appliance on each side which may be those provided in compliance with the requirements of paragraph 1.1.1 or equivalent approved appliances capable of being used on both sides. However, stowage of these liferafts need not comply with the requirements of regulation 13.5.
- 1.2. Passenger ships engaged on short international voyages shall carry:
 - 1.2.1. partially or totally enclosed lifeboats complying with the requirements of section 4.5 or 4.6 of the Code of such aggregate capacity as will accommodate at least 30% of the total number of persons on board. The lifeboats shall, as far as practicable, be equally distributed on each side of the ship. In addition inflatable or rigid liferafts complying with the requirements of section 4.2 or 4.3 of the Code shall be carried of such aggregate capacity that, together with the lifeboat capacity, the survival craft will accommodate the total number of persons on board. The liferafts shall be served by launching appliances equally distributed on each side of the ship; and
 - 1.2.2. in addition, inflatable or rigid liferafts complying with the requirements of section 4.2 or 4.3 of the Code of such aggregate capacity as will accommodate at least 25% of the total number of persons on board. These liferafts shall be served by at least one launching appliance on each side which may be those provided in compliance with the requirements of paragraph 1.2.1 or equivalent approved appliances capable of being used on both sides. However, stowage of these liferafts need not comply with the requirements of regulation 13.5.
- 1.3. All survival craft required to provide for abandonment by the total number of persons on board shall be capable of being launched with their full complement of persons and equipment within a period of 30 min from the time the abandon ship signal is given after all persons have been assembled, with lifejackets donned.
- 1.4. In lieu of meeting the requirements of paragraph 1.1, 1.2 or 1.3, passenger ships of less than 500 gross tonnage where the total number of persons on board is less than 200, may comply with the following:
 - 1.4.1. they shall carry on each side of the ship, inflatable or rigid liferafts complying with the requirements of section 4.2 or 4.3 of the Code and of such aggregate capacity as will accommodate the total number of persons on board;
 - 1.4.2. unless the liferafts required by paragraph 1.5.1 are stowed in a position providing for easy side-to-side transfer at a single open deck level, additional liferafts shall

be provided so that the total capacity available on each side will accommodate 150% of the total number of persons on board;

- 1.4.3. if the rescue boat required by paragraph 2.2 is also a partially or totally enclosed lifeboat complying with the requirements of section 4.5 or 4.6 of the Code, it may be included in the aggregate capacity required by paragraph 1.5.1, provided that the total capacity available on either side of the ship is at least 150% of the total number of persons on board; and
- 1.4.4. in the event of any one survival craft being lost or rendered unserviceable, there shall be sufficient survival craft available for use on each side, including those which are stowed in a position providing for easy side-to-side transfer at a single open deck level, to accommodate the total number of persons on board
- 1.5. A marine evacuation system or systems complying with section 6.2 of the Code may be substituted for the equivalent capacity of liferafts and launching appliances required by paragraph 1.1.1 or 1.2.1.

2. Rescue boats

- 2.1. Passenger ships of 500 gross tonnage and over shall carry at least one rescue boat complying with the requirements of section 5.1 of the Code on each side of the ship.
- 2.2. Passenger ships of less than 500 gross tonnage shall carry at least one rescue boat complying with the requirements of section 5.1 of the Code.
- 2.3. A lifeboat may be accepted as a rescue boat provided that it and its launching and recovery arrangements also comply with the requirements for a rescue boat.

3. Marshalling of liferafts

- 3.1. The number of lifeboats and rescue boats that are carried on passenger ships shall be sufficient to ensure that in providing for abandonment by the total number of persons on board not more than six liferafts need be marshalled by each lifeboat or rescue boat.
- 3.2. The number of lifeboats and rescue boats that are carried on passenger ships engaged on short international voyages shall be sufficient to ensure that in providing for abandonment by the total number of persons on board not more than nine liferafts need be marshalled by each lifeboat or rescue boat.

Regulation 22 – Personal life-saving appliances

1. Lifebuoys

- 1.1. A passenger ship shall carry not less than the number of lifebuoys complying with the requirements of regulation 7.1 and section 2.1 of the Code prescribed in the following table:

Length of ship in metres	Minimum number of lifebuoys
Under 60	8
60 and under 120	12
120 and under 180	18
180 and under 240	24
240 and over	30

- 1.2. Notwithstanding regulation 7.1.3, passenger ships of under 60 m in length shall carry not less than six lifebuoys provided with self-igniting lights.

2. Lifejackets

- 2.1. In addition to the lifejackets required by regulation 7.2, every passenger ship shall carry lifejackets for not less than 5% of the total number of persons on board. These lifejackets shall be stowed in conspicuous places on deck or at muster stations.

- 2.2. Where lifejackets for passengers are stowed in staterooms which are located remotely from direct routes between public spaces and muster stations, the additional lifejackets for these passengers required under regulation 7.2.2, shall be stowed either in the public spaces, the muster stations, or on direct routes between them. The lifejackets shall be stowed so that their distribution and donning does not impede orderly movement to muster stations and survival craft embarkation stations.

3. Lifejacket lights

- 3.1. On all passenger ships each lifejacket shall be fitted with a light complying with the requirements of paragraph 2.2.3 of the Code.
- 3.2. Lights fitted on lifejackets on board passenger ships prior to 1 July 1998 and not complying fully with paragraph 2.2.3 of the Code may be accepted by the Administration until the lifejacket light would normally be replaced or until the first periodical survey after 1 July 2002, whichever is the earliest.

4. Immersion suits and thermal protective aids

- 4.1. All passenger ships shall carry for each lifeboat on the ship at least three immersion suits complying with the requirements of section 2.3 of the Code and, in addition, a thermal protective aid complying with the requirements of section 2.5 of the Code for every person to be accommodated in the lifeboat and not provided with an immersion suit. *Passenger ships operating in Greenland, Arctic and comparable waters shall, for each person on board, carry an immersion suit complying with the requirements of paragraph 2.3 of the Code. During the period from 1 May to 30 September passenger ships may, however, undertake individual voyages without carrying immersion suits for all persons on board on the condition that the persons who are not provided with immersion suits are provided with thermal protective aids.* These immersion suits and thermal protective aids need not be carried:
 - 4.1.1. for persons to be accommodated in totally or partially enclosed lifeboats; or
 - 4.1.2. if the ship is constantly engaged on voyages in warm climates²¹ where, in the opinion of the Administration, they are unnecessary.
- 4.2. The provisions of paragraph 4.1.1 also apply to partially or totally enclosed lifeboats not complying with the requirements of section 4.5 or 4.6 of the Code, provided they are carried on ships constructed before 1 July 1986.

Regulation 23 – Survival craft and rescue boat embarkation arrangements

1. On passenger ships, survival craft embarkation arrangements shall be designed for:
 - 1.1. all lifeboats to be boarded and launched either directly from the stowed position or from an embarkation deck but not both; and
 - 1.2. davit-launched liferafts to be boarded and launched from a position immediately adjacent to the stowed position or from a position to which, in compliance with the requirements of regulation 13.5, the liferaft is transferred prior to launching.
2. Rescue boat arrangements shall be such that the rescue boat can be boarded and launched directly from the stowed position with the number of persons assigned to crew the rescue boat on board. Notwithstanding the requirements of paragraph 1.1, if the rescue boat is also a lifeboat and the other lifeboats are boarded and launched from an embarkation deck, the arrangements shall be such that the rescue boat can also be boarded and launched from the embarkation deck.

²¹ Refer to MSC/Circ. 1046. “Guidelines for the assessment of thermal protection.

Regulation 24 – Stowage of survival craft

The stowage height of a survival craft on a passenger ship shall take into account the requirements of regulation 13.1.2, the escape provisions of regulation II-2/28²², the size of the ship, and the weather conditions likely to be encountered in its intended area of operation. For a davit-launched survival craft, the height of the davit head with the survival craft in embarkation position, shall, as far as practicable, not exceed 15 m to the waterline when the ship is in its lightest seagoing condition.

Regulation 25 – Muster stations

Every passenger ship shall, in addition to complying with the requirements of regulation 11, have passenger muster stations which shall

- 1.1. be in the vicinity of, and permit ready access for the passengers to, the embarkation stations unless in the same location; and
- 1.2. have ample room for marshalling and instruction of the passengers, but at least 0.35 m² per passenger.

Regulation 26 – Additional requirements for ro-ro passenger ships

1. This regulation applies to all ro-ro passenger ships. Ro-ro passenger ships constructed:
 - 1.1. on or after 1 July 1998 shall comply with the requirements of paragraphs 2.3, 2.4, 3.1, 3.2, 3.3, 4 and 5;
 - 1.2. on or after 1 July 1986 and before 1 July 1998 shall comply with the requirements of paragraph 5 not later than the first periodical survey after 1 July 1998 and with the requirements of paragraphs 2.3, 2.4, 3 and 4 not later than the first periodical survey after 1 July 2000; and
 - 1.3. before 1 July 1986 shall comply with the requirements of paragraph 5 not later than the first periodical survey after 1 July 1998 and with the requirements of paragraphs 2.1, 2.2, 2.3, 2.4, 3 and 4 not later than the first periodical survey after 1 July 2000.
 - 1.4. before 1 July 2004 shall comply with the requirements of paragraph 2.5 not later than the first survey or after that date.
2. **Liferafts**
 - 2.1. The ro-ro passenger ship's liferafts shall be served by marine evacuation systems complying with the requirements of section 6.2 of the Code or launching appliances complying with the requirements of paragraph 6.1.5 of the Code, equally distributed on each side of the ship.
 - 2.2. Every liferaft on ro-ro passenger ships shall be provided with float-free stowage arrangements complying with the requirements of regulation 13.4.
 - 2.3. Every liferaft on ro-ro passenger ships shall be of a type fitted with a boarding ramp complying with the requirements of paragraph 4.2.4.1 or 4.3.4.1 of the Code, as appropriate.
 - 2.4. Every liferaft on ro-ro passenger ships shall either be automatically self-righting or be a canopied reversible liferaft which is stable in a seaway and is capable of operating safely whichever way up it is floating. Alternatively, the ship shall carry automatically self-righting liferafts or canopied reversible liferafts, in addition to its normal complement of liferafts, of such aggregate capacity as will accommodate at least 50% of the persons not accommodated in lifeboats. This additional liferaft capacity shall be determined on the basis of the difference between the total number of persons on board and the number of

²² This relates to the chapter II-2 in force before 1 July 2002. The equivalent in the amended chapter II is 13.

persons accommodated in lifeboats. Every such liferaft shall be approved by the Administration having regard to the recommendations adopted by the Organization²³.

- 2.5. Liferafts carried on ro-ro passenger ships shall be fitted with a search and rescue locating device²⁴ in the ratio of one search and rescue locating device for every four liferafts. The search and rescue locating device shall be mounted inside the liferaft so its antenna is more than one metre above the sea level when the liferaft is deployed, except that for canopied reversible liferafts the search and rescue locating device shall be so arranged as to be readily accessed and erected by survivors. Each search and rescue locating device shall be arranged to be manually erected when the liferaft is deployed. Containers of liferafts fitted with search and rescue locating devices shall be clearly marked.

3. Fast rescue boats

- 3.1. At least one of the rescue boats on a ro-ro passenger ship shall be a fast rescue boat complying with section 5.1.4 of the Code.
- 3.2. Each fast rescue boat shall be served by a suitable launching appliance complying with section 6.1.7 in the Code.
- 3.3. At least two crews of each fast rescue boat shall be trained and drilled regularly having regard to the Seafarers Training, Certification and Watchkeeping (STCW) Code and recommendations adopted by the Organization²⁵, including all aspects of rescue, handling, manoeuvring, operating these craft in various conditions, and righting them after capsizing.
- 3.4. In the case where the arrangement or size of a ro-ro passenger ship, constructed before 1 July 1997, is such as to prevent the installation of the fast rescue boat required by paragraph 3.1, the fast rescue boat may be installed in place of an existing lifeboat which is accepted as a rescue boat or, in the case of ships constructed prior to 1 July 1986, boats for use in an emergency, provided that all of the following conditions are met:
 - 3.4.1. the fast rescue boat installed is served by a launching appliance complying with the provisions of paragraph 3.2;
 - 3.4.2. the capacity of the survival craft lost by the above substitution is compensated by the installation of liferafts capable of carrying at least an equal number of persons served by the lifeboat replaced; and
 - 3.4.3. such liferafts are served by the existing launching appliances or marine evacuation systems.

4. Means of rescue²⁶

- 4.1. Each ro-ro passenger ship shall be equipped with efficient means for rapidly recovering survivors from the water and transferring survivors from rescue units or survival craft to the ship.
- 4.2. The means of transfer of survivors to the ship may be part of a marine evacuation system, or may be part of a system designed for rescue purposes.
- 4.3. If the slide of a marine evacuation system is intended to provide the means of transfer of survivors to the deck of the ship, the slide shall be equipped with handlines or ladders to aid in climbing up the slide.

5. Lifejackets

²³ Refer to MSC/Circ.809, Recommendation for canopied reversible liferafts, automatically self-righting liferafts and fast rescue boats, including testing, on ro-ro passenger ships.

²⁴ Refer to Performance standards for survival craft radar transponders for use in search and rescue operations, as adopted by the Organization by Resolution A.802(19).

²⁵ Refer to the Recommendation on training requirements for crews of fast rescue boats adopted by the Organization by resolution A.771(18) and to section A-VI/2, table A-VI/2- 2, "Specification of the minimum standard of competence in fast rescue boats", of the STCW Code.

²⁶ Refer to MSC/Circ. 810, Recommendation on means of rescue on ro-ro passenger ships.

- 5.1. Notwithstanding the requirements of regulations 7.2 and 22.2, a sufficient number of lifejackets shall be stowed in the vicinity of the muster stations so that passengers do not have to return to their cabins to collect their lifejackets.
- 5.2. In ro-ro passenger ships, each lifejacket shall be fitted with a light complying with the requirements of paragraph 2.2.3 of the Code.

Regulation 27 – Information on passengers

1. All persons on board all passenger ships shall be counted prior to departure.
2. Details of persons who have declared a need for special care or assistance in emergency situations shall be recorded and communicated to the master prior to departure.
3. In addition, not later than 1 January 1999, the names and gender of all persons on board, distinguishing between adults, children and infants shall be recorded for search and rescue purposes.
4. The information required by paragraphs 1, 2 and 3 shall be kept ashore and made readily available to search and rescue services when needed.
5. Administrations may exempt passenger ships from the requirements of paragraph 3, if the scheduled voyages of such ships render it impracticable for them to prepare such records.

Regulation 28 – Helicopter landing and pick-up areas

1. All ro-ro passenger ships shall be provided with a helicopter pick-up area approved by the Administration having regard to the recommendations adopted by the Organization.²⁷
2. Ro-ro passenger ships of 130 m in length and upwards, constructed on or after 1 July 1999, shall be fitted with a helicopter landing area approved by the Administration having regard to the recommendations adopted by the Organization.²⁸

Regulation 29 – Decision support system for masters of passenger ships

1. This regulation applies to all passenger ships. Passenger ships constructed before 1 July 1997 shall comply with the requirements of this regulation not later than the date of the first periodical survey after 1 July 1999.
2. In all passenger ships, a decision support system for emergency management shall be provided on the navigation bridge.
3. The system shall, as a minimum, consist of a printed emergency plan or plans²⁹. All foreseeable emergency situations shall be identified in the emergency plan or plans, including, but not limited to, the following main groups of emergencies:
 - 3.1. fire;
 - 3.2. damage to ship;
 - 3.3. pollution;
 - 3.4. unlawful acts threatening the safety of the ship and the security of its passengers and crew;
 - 3.5. personnel accidents;
 - 3.6. cargo-related accidents; and
 - 3.7. emergency assistance to other ships.
4. The emergency procedures established in the emergency plan or plans shall provide decision support to masters for handling any combination of emergency situations.

²⁷ Refer to the International Aeronautical and Maritime Search and Rescue Manual (IAMSAR Manual).

²⁸ Refer to MSC/Circ.895, Recommendation on helicopter landing areas on ro-ro passenger ships.

²⁹ Refer to the the IMO's "International Safety Management (ISM) Code", chapter 8 and Guidelines for a structure of an integrated system of contingency planning for shipboard emergencies adopted by the Organization by resolution A.852(20).

5. The emergency plan or plans shall have a uniform structure and be easy to use. Where applicable, the actual loading condition as calculated for the passenger ship's voyage stability shall be used for damage control purposes.
6. In addition to the printed emergency plan or plans, the Administration may also accept the use of a computer-based decision support system on the navigation bridge which provides all the information contained in the emergency plan or plans, procedures, checklists, etc., which is able to present a list of recommended actions to be carried out in foreseeable emergencies.

Regulation 30 – Drills

1. This regulation applies to all passenger ships.
2. On passenger ships, an abandon ship drill and fire drill shall take place weekly. The entire crew need not be involved in every drill, but each crew member must participate in an abandon ship drill and a fire drill each month as required in regulation 19.3.2. Passengers shall be strongly encouraged to attend these drills.

Section III – Cargo ships

(Additional requirements)

Regulation 31 – Survival craft and rescue boats

1. Survival craft

- 1.1. Cargo ships shall carry:
 - 1.1.1. one or more totally enclosed lifeboats complying with the requirements of section 4.6 of the Code of such aggregate capacity on each side of the ship as will accommodate the total number of persons on board; and
 - 1.1.2. in addition, one or more inflatable or rigid liferafts, complying with the requirements of section 4.2 or 4.3 of the Code, of a mass of less than 185 kg and stowed in a position providing for easy side-to-side transfer at a single open deck level, and of such aggregate capacity as will accommodate the total number of persons on board. If the liferaft or liferafts are not of a mass of less than 185 kg and stowed in a position providing for easy side-to-side transfer at a single open deck level, the total capacity available on each side shall be sufficient to accommodate the total number of persons on board.
- 1.2. In lieu of meeting the requirements of paragraph 1.1, cargo ships may carry:
 - 1.2.1. one or more free-fall lifeboats, complying with the requirements of section 4.7 of the Code, capable of being free-fall launched over the stern of the ship of such aggregate capacity as will accommodate the total number of persons on board; and
 - 1.2.2. in addition, one or more inflatable or rigid liferafts complying with the requirements of section 4.2 or 4.3 of the Code, on each side of the ship, of such aggregate capacity as will accommodate the total number of persons on board. The liferafts on at least one side of the ship shall be served by launching appliances.
- 1.3. In lieu of meeting the requirements of paragraph 1.1 or 1.2, cargo ships of less than 85m in length other than oil tankers, chemical tankers and gas carriers *with a gross tonnage of 500 or more*, may comply with the following:

- 1.3.1. they shall carry on each side of the ship, one or more inflatable or rigid liferafts complying with the requirements of section 4.2 or 4.3 of the Code and of such aggregate capacity as will accommodate the total number of persons on board;
 - 1.3.2. unless the liferafts required by paragraph 1.3.1 are of a mass of less than 185 kg and stowed in a position providing for easy side-to-side transfer at a single open deck level, additional liferafts shall be provided so that the total capacity available on each side will accommodate 150% of the total number of persons on board;
 - 1.3.3. if the rescue boat required by paragraph 2 is also a totally enclosed lifeboat complying with the requirements of section 4.6 of the Code, it may be included in the aggregate capacity required by paragraph 1.3.1, provided that the total capacity available on either side of the ship is at least 150% of the total number of persons on board; and
 - 1.3.4. in the event of any one survival craft being lost or rendered unserviceable, there shall be sufficient survival craft available for use on each side, including any which are of a mass of less than 185 kg and stowed in a position providing for easy side-to-side transfer at a single open deck level, to accommodate the total number of persons on board.
- 1.4. Cargo ships where the horizontal distance from the extreme end of the stem or stern of the ship to the nearest end of the closest survival craft is more than 100 m shall carry, in addition to the liferafts required by paragraphs 1.1.2 and 1.2.2, a liferaft stowed as far forward or aft, or one as far forward and another as far aft, as is reasonable and practicable. Such liferaft or liferafts may be securely fastened so as to permit manual release and need not be of the type which can be launched from an approved launching device. *The liferaft shall be so stowed that it may be transferred to either side of the ship. Such arrangements shall be made that the raft may be launched without the necessity of lifting it over rails or bulwarks. There shall also be emergency lighting at the place where the raft is stowed. A portable safety lamp of an approved type may be used for this purpose. The release line – the painter – shall be secured to the place where the raft is stowed in such a way that it may be easily released for attachment to the place where the raft may be launched.*
- 1.5. With the exception of the survival craft referred to in regulation 16.1.1, all survival craft required to provide for abandonment by the total number of persons on board shall be capable of being launched with their full complement of persons and equipment within a period of 10 min from the time the abandon ship signal is given.
- 1.6. Chemical tankers and gas carriers carrying cargoes emitting toxic vapours or gases³⁰ shall carry, in lieu of totally enclosed lifeboats complying with the requirements of section 4.6 of the Code, lifeboats with a self-contained air support system complying with the requirements of section 4.8 of the Code.
- 1.7. Oil tankers, chemical tankers and gas carriers *with a gross tonnage over 500* carrying cargoes having a flashpoint not exceeding 60° C (closed-cup test) shall carry, in lieu of totally enclosed lifeboats complying with the requirements of section 4.6 of the Code, fire-protected lifeboats complying with the requirements of section 4.9 of the Code.

³⁰ Refer to the products for which emergency escape respiratory protection is required in chapter 17 of the International Code for the Construction and Equipment of Ships Carrying Dangerous Chemicals in Bulk (IBC Code), adopted by the Maritime Safety Committee by resolution MSC.4(48), as amended, and in chapter 19 of the International Code for the Construction and Equipment of Ships Carrying Liquefied Gases in Bulk (IGC Code), adopted by the Maritime Safety Committee by resolution MSC.5(48), as amended.

- 1.8. Regardless of the requirements in paragraph 1.1, bulk carriers as defined in regulation IX/1.6, built on or after 1 July 2006, must comply with the requirements in paragraph 1.2.

2. Rescue boats

Cargo ships *with a gross tonnage of 100 or more* shall carry at least one rescue boat complying with the requirements of section 5.1 of the Code. A lifeboat may be accepted as a rescue boat, provided that it and its launching and recovery arrangements also comply with the requirements for a rescue boat.

3. In addition to their lifeboats, all cargo ships *with a gross tonnage of 500 or more* constructed before 1 July 1986 shall carry:
- 3.1. one or more liferafts capable of being launched on either side of the ship and of such aggregate capacity as will accommodate the total number of persons on board. The liferaft or liferafts shall be equipped with a lashing or an equivalent means of securing the liferaft which will automatically release it from a sinking ship; and
 - 3.2. where the horizontal distance from the extreme end of the stem or stern of the ship to the nearest end of the closest survival craft is more than 100 m, in addition to the liferafts required by paragraph 3.1, a liferaft stowed as far forward or aft, or one as far forward and another as far aft, as is reasonable and practicable. Notwithstanding the requirements of paragraph 3.1, such liferaft or liferafts may be securely fastened so as to permit manual release.

Regulation 32 – Personal life-saving appliances

1. Lifebuoys

- 1.1. Cargo ships shall carry not less than the number of lifebuoys complying with the requirements of regulation 7.1 and section 2.1 of the Code prescribed in the following table:
- 1.2. Self-igniting lights for lifebuoys on tankers required by regulation 7.1.3 shall be of an electric battery type.

Length of ship in metres	Minimum number of lifebuoys
<i>15 and under 30</i>	<i>4</i>
<i>30 and under 50</i>	<i>6</i>
<i>50 and under 100</i>	<i>8</i>
<i>100 and under 150</i>	<i>10</i>
<i>150 and under 200</i>	<i>12</i>
<i>200 and over</i>	<i>14</i>

1. Lifejacket lights

- 1.1. This paragraph applies to all cargo ships.
- 1.2. On cargo ships, each lifejacket shall be fitted with a lifejacket light complying with the requirements of paragraph 2.2.3 of the Code.
- 1.3. Lights fitted on lifejackets on board cargo ships prior to 1 July 1998 and not complying fully with paragraph 2.2.3 of the Code may be accepted by the Administration until the lifejacket light would normally be replaced or until the first periodical survey after 1 July 2001, whichever is the earliest.

3. Immersion suits

- 3.1. This paragraph applies to all *new and existing* cargo ships. However, with respect to cargo ships constructed before 1 July 2006, paragraphs 3.2 to 3.5 shall be complied with not later than the first safety equipment survey on or after 1 July 2006.

- 3.2. An immersion suit of an appropriate size complying with the requirements of section 2.3 of the Code shall be provided for every person on board the ship. However, for ships other than bulk carriers, as defined in regulation IX/1, these immersion suits need not be required if the ship is constantly engaged on voyages in warm climates where, in the opinion of the Administration, immersion suits are unnecessary.
- 3.3. If a ship has any watch or work stations which are located remotely from the place or places where immersion suits are normally stowed, including remotely located survival craft carried in accordance with regulation 31.1.4, additional immersion suits of an appropriate size shall be provided at these locations for the number of persons normally on watch or working at those locations at any time.
- 3.4. Immersion suits shall be so placed as to be readily accessible and their position shall be plainly indicated.
- 3.5. The immersion suits required by this regulation may be used to comply with the requirements of regulation 7.3.

Regulation 33 – Survival craft embarkation and launching arrangements

1. Cargo ship survival craft embarkation arrangements shall be so designed that lifeboats can be boarded and launched directly from the stowed position and davit-launched liferafts can be boarded and launched from a position immediately adjacent to the stowed position or from a position to which the liferaft is transferred prior to launching in compliance with the requirements of regulation 13.5.
2. On cargo ships of 20,000 gross tonnage and upwards, lifeboats shall be capable of being launched, where necessary utilizing painters, with the ship making headway at speeds up to 5 knots in calm water.

Section IV – Life-saving appliances and arrangement requirements

Regulation 34 – Application of the LSA-Code

1. All life-saving appliances and arrangements shall comply with the applicable requirements of the Code.

Section V – Miscellaneous

Regulation 35 – Training manual and on-board training aids

1. This regulation applies to all ships.
2. A training manual complying with the requirements of paragraph 3 shall be provided in each crew mess room and recreation room or in each crew cabin.
3. The training manual, which may comprise several volumes, shall contain instructions and information, in easily understood terms illustrated wherever possible, on the life-saving appliances provided in the ship and on the best methods of survival. Any part of such information may be provided in the form of audiovisual aids in lieu of the manual. The following shall be explained in detail:
 - 3.1. donning of lifejackets, immersion suits and anti-exposure suits, as appropriate;
 - 3.2. muster at the assigned stations;
 - 3.3. boarding, launching, and clearing the survival craft and rescue boats, including, where applicable, use of marine evacuation systems;
 - 3.4. method of launching from within the survival craft;
 - 3.5. release from launching appliances;

- 3.6. methods and use of devices for protection in launching areas, where appropriate;
 - 3.7. illumination in launching areas;
 - 3.8. use of all survival equipment;
 - 3.9. use of all detection equipment;
 - 3.10. with the assistance of illustrations, the use of radio life-saving appliances;
 - 3.11. use of drogues;
 - 3.12. use of engine and accessories;
 - 3.13. recovery of survival craft and rescue boats including stowage and securing;
 - 3.14. hazards of exposure and the need for warm clothing;
 - 3.15. best use of the survival craft facilities in order to survive;
 - 3.16. methods of retrieval, including the use of helicopter rescue gear (slings, baskets, stretchers), breeches-buoy and shore life-saving apparatus and ship's line-throwing apparatus;
 - 3.17. all other functions contained in the muster list and emergency instructions; and
 - 3.18. instructions for emergency repair of the life-saving appliances.
4. Every ship fitted with a marine evacuation system shall be provided with on-board training aids in the use of the system (*e.g. instruction books and videotapes*).
 5. The training manual shall be written in the working language of the ship.

Regulation 36 – Instructions for on-board maintenance

Instructions for on-board maintenance of life-saving appliances shall be easily understood, illustrated wherever possible, and, as appropriate, shall include the following for each appliance:

- 1.1. a checklist for use when carrying out the inspections required by regulation 20.7;
- 1.2. maintenance and repair instructions;
- 1.3. schedule of periodic maintenance;
- 1.4. diagram of lubrication points with the recommended lubricants;
- 1.5. list of replaceable parts;
- 1.6. list of sources of spare parts; and
- 1.7. log for records of inspections and maintenance.

Regulation 37 – Muster list and emergency instructions

1. The muster list shall specify details of the general emergency alarm and public address system prescribed by section 7.2 of the Code and also action to be taken by crew and passengers when this alarm is sounded. The muster list shall also specify how the order to abandon ship will be given.
2. Each passenger ship shall have procedures in place for locating and rescuing passengers trapped in their staterooms.
3. The muster list shall show the duties assigned to the different members of the crew including:
 - 3.1. closing of the watertight doors, fire doors, valves, scuppers, side scuttles, skylights, portholes and other similar openings in the ship;
 - 3.2. equipping of the survival craft and other life-saving appliances;
 - 3.3. preparation and launching of survival craft;
 - 3.4. general preparations of other lifesaving appliances;
 - 3.5. muster of passengers;
 - 3.6. use of communication equipment;
 - 3.7. manning of fire parties assigned to deal with fires; and
 - 3.8. special duties assigned in respect to the use of fire-fighting equipment and installations.

4. The muster list shall specify which officers are assigned to ensure that life-saving and fire appliances are maintained in good condition and are ready for immediate use.
5. The muster list shall specify substitutes for key persons who may become disabled, taking into account that different emergencies may call for different actions.
6. The muster list shall show the duties assigned to members of the crew in relation to passengers in case of emergency. These duties shall include:
 - 6.1. warning the passengers;
 - 6.2. seeing that they are suitably clad and have donned their lifejackets correctly;
 - 6.3. assembling passengers at muster stations;
 - 6.4. keeping order in the passageways and on the stairways and generally controlling the movements of the passengers; and
 - 6.5. ensuring that a supply of blankets is taken to the survival craft.
7. The muster list shall be prepared before the ship proceeds to sea. After the muster list has been prepared, if any change takes place in the crew which necessitates an alteration in the muster list, the master shall either revise the list or prepare a new list.
8. The format of the muster list used on passenger ships shall be approved. *A copy of the muster list shall be submitted to the Danish Maritime Authority for approval.*

Part C – Alternative design and arrangements

Regulation 38 – Alternative design and arrangements

1. Purpose

The purpose of this regulation is to provide a methodology for alternative design and arrangements for life-saving appliances and arrangements.

2. General

- 2.1. Life-saving appliances and arrangements may deviate from the requirements set out in part B, provided that the alternative design and arrangements meet the intent of the requirements concerned and provide an equivalent level of safety to this chapter.
- 2.2. When alternative design or arrangements deviate from the prescriptive requirements of part B, an engineering analysis, evaluation and approval of the design and arrangements shall be carried out in accordance with this regulation.

3. Engineering analysis

The engineering analysis shall be prepared and submitted to the Administration, based on the guidelines developed by the Organization³¹ and shall include, as a minimum, the following elements:

- 3.1. determination of the ship type and the life-saving appliance and arrangements concerned;
- 3.2. identification of the prescriptive requirement(s) with which the life-saving appliance and arrangements will not comply;
- 3.3. identification of the reason the proposed design will not meet the prescriptive requirements supported by compliance with other recognized engineering or industry standards;
- 3.4. determination of the performance criteria for the ship and the life-saving appliance and arrangements concerned addressed by the relevant prescriptive requirement(s):
 - 3.4.1. performance criteria shall provide a level of safety not inferior to the relevant prescriptive requirements contained in part B; and
 - 3.4.2. performance criteria shall be quantifiable and measurable;

³¹ Refer to the Guidelines on alternative design and arrangements for SOLAS chapters II-1 and III (MSC.1/Circ.1212).

- 3.5. detailed description of the alternative design and arrangements, including a list of the assumptions used in the design and any proposed operational restrictions or conditions;
- 3.6. technical justification demonstrating that the alternative design and arrangements meet the safety performance criteria; and
- 3.7. risk assessment based on identification of the potential faults and hazards associated with the proposal.

4. Evaluation of the alternative design and arrangements

- 4.1. The engineering analysis required in paragraph 3 shall be evaluated and approved by the Administration, taking into account the guidelines developed by the Organization.³²
- 4.2. A copy of the documentation, as approved by the Administration, indicating that the alternative design and arrangements comply with this regulation, shall be carried on board the ship.

5. Exchange of information

The Administration shall communicate to the Organization pertinent information concerning alternative design and arrangements approved by them for circulation to all Contracting Governments.

6. Re-evaluation due to change of conditions

If the assumptions and operational restrictions that were stipulated in the alternative design and arrangements are changed, the engineering analysis shall be carried out under the changed condition and shall be approved by the Administration.

³² Refer to the Guidelines on alternative design and arrangements for SOLAS chapters II-1 and III (MSC.1/Circ.1212).

Notice from the Danish Maritime Authority B – The Construction and Equipment, etc. of Ships

Chapter B IV

Radiocommunications GMDSS

Regulation 1 – Application.....	2
Regulation 2 – Terms and definitions	2
Regulation 3 – Exemptions.....	3
Regulation 4 – Functional requirements.....	4
Regulation 4-1 – GMDSS satellite providers.....	4
Regulation 5 – Provision of radiocommunication services.....	4
Regulation 5-1 – Global maritime distress and safety system identities	5
Regulation 6 – Radio installations	5
Regulation 7 – Radio equipment: General	6
Regulation 8 – Radio equipment: Sea area A1.....	7
Regulation 9 – Radio equipment: Sea areas A1 and A2.....	8
Regulation 10 – Radio equipment: Sea areas A1, A2 and A3	9
Regulation 11 – Radio equipment: Sea areas A1, A2, A3 and A4	10
Regulation 12 – Watches	11
Regulation 13 – Sources of energy.....	11
Regulation 14 – Performance standards.....	12
Regulation 15 – Maintenance requirements.....	13
Regulation 16 – Radio personnel.....	14
Regulation 17 – Radio records.....	14
Regulation 18 – Position updating.....	14

Part A – General

Regulation 1 – Application

1. Unless expressly provided otherwise, this chapter applies to all ships to which the present regulations apply, *cf. chapter I, part A*, and to cargo ships engaged on international voyages of 300 gross tonnage and upwards.
*From 1 February 2001, this chapter shall also apply to cargo ships of a gross tonnage below 300, but with a length (L) of 15 m and above or a scantling number¹ of 100 and above. For cargo ships engaged on domestic voyages, the provisions of this chapter shall, however, not apply until 1 February 2003. Any exemptions are mentioned at the end of each regulation.
The provisions shall apply to both new and existing ships.*
2. This chapter does not apply to ships to which the present regulations would otherwise apply while such ships are being navigated within the Great Lakes of North America and their connecting and tributary waters as far east as the lower exit of the St Lambert Lock at Montreal in the Province of Quebec, Canada.²
3. No provision in this chapter shall prevent the use by any ship, survival craft or person in distress, of any means at their disposal to attract attention, make known their position and obtain help.

Regulation 2 – Terms and definitions

1. For the purpose of this chapter, the following terms shall have the meanings defined below:
 - 1.1. “Bridge-to-bridge communications” means safety communications between ships from the position from which the ships are normally navigated.
 - 1.2. “Continuous watch” means that the radio watch concerned shall not be interrupted other than for brief intervals when the ship's receiving capability is impaired or blocked by its own communications or when the facilities are under periodical maintenance or checks.
 - 1.3. “Digital selective calling (DSC)” means a technique using digital codes which enables a radio station to establish contact with, and transfer information to, another station or group of stations, and complying with the relevant recommendations of the International Radiocommunication Sector (ITU-R).
 - 1.4. “Direct-printing telegraphy” means automated telegraphy techniques which comply with the relevant recommendations of the International Radiocommunication Sector (ITU-R).
 - 1.5. “General radiocommunications” means operational and public correspondence traffic, other than distress, urgency and safety messages, conducted by radio.
 - 1.6. “INMARSAT” means the Organization established by the Convention on the International Maritime Satellite Organization adopted on 3 September 1976.
 - 1.7. “International NAVTEX service” means the co-ordinated broadcast and automatic reception on 518 kHz of maritime safety information by means of narrow-band direct-printing telegraphy using the English language.³

¹ Cf. the definition in regulation I/2.

² Such ships are subject to special requirements relative to radio for safety purposes, as contained in the relevant agreement between Canada and the United States of America.

³ Refer to the NAVTEX Manual approved by the Organization (publication IMO-951E).

- 1.8. "Locating" means the finding of ships, aircraft, units or persons in distress.
- 1.9. "Maritime safety information" means navigational and meteorological warnings, meteorological forecasts and other urgent safety related messages broadcast to ships.
- 1.10. "Polar orbiting satellite service" means a service which is based on polar orbiting satellites which receive and relay distress alerts from satellite EPIRBs and which provides their position.
- 1.11. "Radio Regulations" means the Radio Regulations annexed to, or regarded as being annexed to, the most recent International Telecommunication Convention which is in force at any time.
- 1.12. "Sea area A1" means an area within the radiotelephone coverage of at least one VHF coast station in which continuous DSC alerting is available, as may be defined by a Contracting Government.⁴
- 1.13. "Sea area A2" means an area, excluding sea area A1, within the radiotelephone coverage of at least one MF coast station in which continuous DSC alerting is available, as may be defined by a Contracting Government.⁵
- 1.14. "Sea area A3" means an area, excluding sea areas A1 and A2, within the coverage of an INMARSAT geostationary satellite in which continuous alerting is available.
- 1.15. "Sea area A4" means an area outside sea areas A1, A2 and A3.
- 1.16. "Global maritime distress and safety system (GMDSS) identities" means maritime mobile services identity, the ship's call sign, Inmarsat identities and serial number identity which may be transmitted by the ship's equipment and used to identify the ship.
- 1.17. "*EPIRB*" (*Emergency Position Indicating Radio Beacon*) is a satellite emergency position indicator radio transmitter.
- 1.18. "*MMSI*" (*Maritime Mobile Service Identity*) is a 9-digit number that identifies the ship on, among other things, DSC equipment and EPIRBs.
- 1.19. "*Float-free EPIRB*" means an EPIRB placed in a holder arranged so that the EPIRB automatically floats free of the ship and is activated if the ship sinks.
2. All other terms and abbreviations which are used in this chapter and which are defined in the Radio Regulations and in the International Convention on Maritime Search and Rescue (SAR), 1979, as may be amended, shall have the meanings as defined in those Regulations and the SAR Convention.

Regulation 3 – Exemptions

1. The Contracting Governments consider it highly desirable not to deviate from the requirements of this chapter; nevertheless the Administration may grant partial or conditional exemptions to individual ships from the requirements of regulations 7 to 11 provided:
 - 1.1. such ships comply with the functional requirements of regulation 4; and
 - 1.2. the Administration has taken into account the effect such exemptions may have upon the general efficiency of the service for the safety of all ships.
2. An exemption may be granted under paragraph 1 only:

⁴ Refer to resolution A.801(19) concerning provision of radio services for the global maritime distress and safety system (GMDSS).

⁵ Refer to resolution A.801(19) concerning provision of radio services for the global maritime distress and safety system (GMDSS).

- 2.1. if the conditions affecting safety are such as to render the full application of regulations 7 to 11 unreasonable or unnecessary;
 - 2.2. in exceptional circumstances, for a single voyage outside the sea area or sea areas for which the ship is equipped.
3. Each Administration shall submit to the Organization, as soon as possible after the first of January in each year, a report showing all exemptions granted under paragraphs 1 and 2 during the previous calendar year and giving the reasons for granting such exemptions.

Regulation 4 – Functional requirements⁶

1. Every ship, while at sea, shall be capable:
 - 1.1. except as provided in regulations 8.1.1 (*VHF DSC*) and 10.1.4.3 (*INMARSAT*), of transmitting ship-to-shore distress alerts by at least two separate and independent means, each using a different radiocommunication service;
 - 1.2. of receiving shore-to-ship distress alerts;
 - 1.3. of transmitting and receiving ship-to-ship distress alerts;
 - 1.4. of transmitting and receiving search and rescue co-ordinating communications;
 - 1.5. of transmitting and receiving on-scene communications;
 - 1.6. of transmitting and, as required by regulation V/19.2.3.2, receiving signals for locating;⁷
 - 1.7. of transmitting and receiving⁸ maritime safety information;
 - 1.8. of transmitting and receiving general radiocommunications to and from shorebased radio systems or networks subject to regulation 15.8; and
 - 1.9. of transmitting and receiving bridge-to-bridge communications.

Regulation 4-1 – GMDSS satellite providers

The Maritime Safety Committee shall determine the criteria, procedures and arrangements for the evaluation, recognition, review and oversight of the provision of mobile satellite communication services in the Global Maritime Distress and Safety Systems (GMDSS) pursuant to the provisions of this chapter.

Part B – Undertakings by Contracting Governments⁹

Regulation 5 – Provision of radiocommunication services

1. Each Contracting Government undertakes to make available, as it deems practical and necessary either individually or in co-operation with other Contracting Governments, appropriate shore-based facilities for space and terrestrial radiocommunication services having due regard to the recommendations of the Organization.¹⁰ These services are:

⁶ It should be noted that ships performing GMDSS functions should use the Guidance for avoidance of false distress alerts adopted by the Organization by resolution A.814(19).

⁷ Refer to resolution A.614(15) concerning carriage of radar operating in the frequency band 9,300-9,500 MHz.

⁸ It should be noted that ships may have a need for reception of certain maritime safety information while in port.

⁹ **1.** Each Contracting Government is not required to provide all radiocommunication services. **2.** The requirements should be specified for shore-based facilities to cover the various sea areas.

¹⁰ Refer to resolution A.801(19) concerning provision of radio services for the global maritime distress and safety system (GMDSS).

- 1.1. a radiocommunication service utilizing geostationary satellites in the Maritime Mobile-Satellite Service;
 - 1.2. a radiocommunication service utilizing polar orbiting satellites in the mobile satellite service;
 - 1.3. the maritime mobile service in the bands between 156 MHz and 174 MHz;
 - 1.4. the maritime mobile service in the bands between 4,000 kHz and 27,500 kHz; and
 - 1.5. the maritime mobile service in the bands between 415 kHz and 535 kHz and between 1,605 kHz and 4,000 kHz.
2. Each Contracting Government undertakes to provide the Organization with pertinent information concerning the shore-based facilities in the maritime mobile service, mobile-satellite service and Maritime Mobile-Satellite Service, established for sea areas which it has designated off its coasts.¹¹

Regulation 5-1 – Global maritime distress and safety system identities

1. This regulation applies to all ships on all voyages.
2. Each Contracting Government undertakes to ensure that suitable arrangements are made for registering global maritime distress and safety system (GMDSS) identities and for making information on these identities available to rescue co-ordination centres on a 24-hour basis. Where appropriate, international organizations maintaining a registry of these identities shall be notified by the Contracting Government of these assignments.

Part C – Ship requirements

Regulation 6 – Radio installations

1. Every ship shall be provided with radio installations capable of complying with the functional requirements prescribed by regulation 4 throughout its intended voyage and, unless exempted under regulation 3, complying with the requirements of regulation 7 and, as appropriate for the sea area or areas through which it will pass during its intended voyage, the requirements of either regulation 8, 9, 10 or 11.
2. Every radio installation shall:
 - 2.1. be so located that no harmful interference of mechanical, electrical or other origin affects its proper use, and so as to ensure electromagnetic compatibility and avoidance of harmful interaction with other equipment and systems;
 - 2.2. be so located as to ensure the greatest possible degree of safety and operational availability;
 - 2.3. be protected against harmful effects of water, extremes of temperature and other adverse environmental conditions;
 - 2.4. be provided with reliable, permanently arranged electrical lighting, independent of the main and emergency sources of electrical power, for the adequate illumination of the radio controls for operating the radio installation; and
 - 2.5. be clearly marked with the ship's name, call sign, *MMSI number and any Inmarsat numbers*.
3. Control of the VHF radiotelephone channels, required for navigational safety, shall be immediately available on the navigation bridge convenient to the conning position and, where necessary, facilities should be available to permit radiocommunications from the wings of the navigation bridge. Portable VHF equipment may be used to meet the latter provision.

¹¹ The Master Plan of shore-based facilities for the GMDSS based on information provided by Contracting Governments is circulated to all concerned by means of GMDSS circulars.

4. In passenger ships, a distress panel shall be installed at the conning position. This panel shall contain either one single button which, when pressed, initiates a distress alert using all radiocommunication installations required on board for that purpose or one button for each individual installation. The panel shall clearly and visually indicate whenever any button or buttons have been pressed. Means shall be provided to prevent inadvertent activation of the button or buttons. If the satellite EPIRB is used as the secondary means of distress alerting and is not remotely activated, it shall be acceptable to have an additional EPIRB installed in the wheelhouse near the conning position.
5. Information on the ship's position shall be continuously and automatically provided to all relevant radiocommunication equipment (*DSC and Inmarsat*) to be included in the initial distress alert when the button or buttons on the distress panel is pressed.
6. In passenger ships, a distress alarm panel shall be installed at the conning position. The distress alarm panel shall provide visual and aural indication of any distress alert or alerts received on board and shall also indicate through which radiocommunication service the distress alerts have been received.

Regulation 7 – Radio equipment: General

1. Every ship shall be provided with:
 - 1.1. a VHF radio installation capable of transmitting and receiving:
 - 1.1.1. DSC on the frequency 156.525 MHz (channel 70). It shall be possible to initiate the transmission of distress alerts on channel 70 from the position from which the ship is normally navigated¹²; and
 - 1.1.2. radiotelephony on the frequencies 156.300 MHz (channel 6), 156.650 MHz (channel 13) and 156.800 MHz (channel 16);
 - 1.2. a radio installation capable of maintaining a continuous DSC watch on VHF channel 70 which may be separate from, or combined with, that required by subparagraph 1.1;
 - 1.3. a search and rescue locating device capable of operating either in the 9 GHz band or on frequencies dedicated for AIS, which:
 - 1.3.1. shall be so stowed that it can be easily utilized; and
 - 1.3.2. may be one of those required by regulation III/6.2.2 for a survival craft;
 - 1.4. a receiver capable of receiving international NAVTEX service broadcasts if the ship is engaged on voyages in any area in which an international NAVTEX service is provided;
 - 1.5. a radio facility for reception of maritime safety information by the INMARSAT enhanced group calling system¹³ if the ship is engaged on voyages in any area of INMARSAT coverage but in which an international NAVTEX service is not provided.
However, ships engaged exclusively on voyages in areas where an HF direct printing telegraphy maritime safety information service is provided and fitted with equipment capable of receiving such service, may be exempt from this requirement.¹⁴

¹² Certain ships may be exempted from this requirement (see regulation 9.4).

¹³ Refer to resolution A.701(17) concerning carriage of INMARSAT enhanced group call SafetyNET receivers under the GMDSS.

¹⁴ Refer to the Recommendation on promulgation of maritime safety information adopted by the Organization by resolution A.705(17).

- 1.6. subject to the provisions of regulation 8.3, a satellite emergency position indicating radio beacon (satellite EPIRB)¹⁵ which shall be:
 - 1.6.1. capable of transmitting a distress alert either through the polar orbiting satellite service operating in the 406 MHz band or, if the ship is engaged only on voyages within INMARSAT coverage, through the INMARSAT geostationary satellite service operating in the 1.6 GHz band¹⁶;
 - 1.6.2. installed in an easily accessible position;
 - 1.6.3. ready to be manually released and capable of being carried by one person into a survival craft;
 - 1.6.4. capable of floating free if the ship sinks and of being automatically activated when afloat (float-free); and
 - 1.6.5. capable of being activated manually.
2. Every passenger ship shall be provided with means for two-way on-scene radiocommunications for search and rescue purposes using the aeronautical frequencies 121.5 MHz and 123.1 MHz from the position from which the ship is normally navigated.

Regulation 8 – Radio equipment: Sea area A1

1. In addition to meeting the requirements of regulation 7, every ship engaged on voyages exclusively in sea area A1 shall be provided with a radio installation capable of initiating the transmission of ship-to-shore distress alerts from the position from which the ship is normally navigated, operating either:
 - 1.1. on VHF using DSC; this requirement may be fulfilled by the EPIRB prescribed by paragraph 3, either by installing the EPIRB close to, or by remote activation from, the position from which the ship is normally navigated; or
 - 1.2. through the polar orbiting satellite service on 406 MHz; this requirement may be fulfilled by the satellite EPIRB, required by regulation 7.1.6, either by installing the satellite EPIRB close to, or by remote activation from, the position from which the ship is normally navigated; or
 - 1.3. if the ship is engaged on voyages within coverage of MF coast stations equipped with DSC, on MF using DSC; or
 - 1.4. on HF using DSC; or
 - 1.5. through the INMARSAT geostationary satellite service; this requirement may be fulfilled by:
 - 1.5.1. an INMARSAT ship earth station¹⁷; or
 - 1.5.2. the satellite EPIRB, required by regulation 7.1.6, either by installing the satellite EPIRB close to, or by remote activation from, the position from which the ship is normally navigated.

Cargo ships engaged on domestic voyages shall be exempted from the requirement in regulation 8.1. for secondary means of alerts.

¹⁵ Refer to resolution A.616(15) concerning search and rescue homing capability.

¹⁶ Subject to the availability of appropriate receiving and processing ground facilities for each ocean region covered by Inmarsat satellites.

¹⁷ This requirement can be met by Inmarsat ship earth stations capable of two-way communications, such as Inmarsat-A, Inmarsat-B (resolution A.808(19)) or Inmarsat-C (resolution A.807(19)) ship earth stations. Unless otherwise specified, this footnote applies to all requirements for an Inmarsat ship earth station prescribed by this chapter.

2. The VHF radio installation, required by regulation 7.1.1, shall also be capable of transmitting and receiving general radiocommunications using radiotelephony.
3. Ships engaged on voyages exclusively in sea area A1 may carry, in lieu of the satellite EPIRB required by regulation 7.1.6, an EPIRB which shall be:
 - 3.1. capable of transmitting a distress alert using DSC on VHF channel 70 and providing for locating by means of a radar transponder operating in the 9 GHz band;
 - 3.2. installed in an easily accessible position;
 - 3.3. ready to be manually released and capable of being carried by one person into a survival craft;
 - 3.4. capable of floating free if the ship sinks and being automatically activated when afloat; and
 - 3.5. capable of being activated manually.

Regulation 9 – Radio equipment: Sea areas A1 and A2

1. In addition to meeting the requirements of regulation 7, every ship engaged on voyages beyond sea area A1, but remaining within sea area A2, shall be provided with:
 - 1.1. an MF radio installation capable of transmitting and receiving, for distress and safety purposes, on the frequencies:
 - 1.1.1. 2,187.5 kHz using DSC; and
 - 1.1.2. 2,182 kHz using radiotelephony;
 - 1.2. a radio installation capable of maintaining a continuous DSC watch on the frequency 2,187.5 kHz which may be separate from, or combined with, that required by subparagraph .1.1; and
 - 1.3. means of initiating the transmission of ship-to-shore distress alerts by a radio service other than MF operating either:
 - 1.3.1. through the polar orbiting satellite service on 406 MHz; this requirement may be fulfilled by the satellite EPIRB, required by regulation 7.1.6, either by installing the satellite EPIRB close to, or by remote activation from, the position from which the ship is normally navigated; or
 - 1.3.2. on HF using DSC; or
 - 1.3.3. through the INMARSAT geostationary satellite service by a ship earth station; this requirement may be fulfilled by:
 - 1.3.3.1. the equipment specified in paragraph 3.2; or
 - 1.3.3.2. the satellite EPIRB, required by regulation 7.1.6, either by installing the satellite EPIRB close to, or by remote activation from, the position from which the ship is normally navigated.

Cargo ships engaged on domestic voyages shall be exempted from the requirement in regulation 9.1.3 for secondary means of alerts.

2. It shall be possible to initiate transmission of distress alerts by the radio installations specified in paragraphs 1.1 and 1.3 from the position from which the ship is normally navigated.
3. The ship shall, in addition, be capable of transmitting and receiving general radiocommunications using radiotelephony or direct-printing telegraphy by either:
 - 3.1. a radio installation operating on working frequencies in the bands between 1,605 kHz and 4,000 kHz or between 4,000 kHz and 27,500 kHz. This requirement may be fulfilled by the addition of this capability in the equipment required by paragraph 1.1; or
 - 3.2. an INMARSAT ship earth station.

4. The Administration may exempt ships constructed before 1 February 1997, which are engaged exclusively on voyages within sea area A2, from the requirements of regulations 7.1.1.1 and 7.1.2 provided such ships maintain, when practicable, a continuous listening watch on VHF channel 16. This watch shall be kept at the position from which the ship is normally navigated.

Regulation 10 – Radio equipment: Sea areas A1, A2 and A3

Alternative 1

1. In addition to meeting the requirements of regulation 7, every ship engaged on voyages beyond sea areas A1 and A2, but remaining within sea area A3, shall, if it does not comply with the requirements of paragraph 2, be provided with:
 - 1.1. an INMARSAT ship earth station capable of:
 - 1.1.1. transmitting and receiving distress and safety communications using direct-printing telegraphy;
 - 1.1.2. initiating and receiving distress priority calls;
 - 1.1.3. maintaining watch for shore-to-ship distress alerts, including those directed to specifically defined geographical areas;
 - 1.1.4. transmitting and receiving general radiocommunications, using either radiotelephony or direct-printing telegraphy; and
 - 1.2. an MF radio installation capable of transmitting and receiving, for distress and safety purposes, on the frequencies:
 - 1.2.1. 2,187.5 kHz using DSC; and
 - 1.2.2. 2,182 kHz using radiotelephony; and
 - 1.3. a radio installation capable of maintaining a continuous DSC watch on the frequency 2,187.5 kHz which may be separate from or combined with that required by subparagraph .2.1; and
 - 1.4. means of initiating the transmission of ship-to-shore distress alerts by a radio service operating either:
 - 1.4.1. through the polar orbiting satellite service on 406 MHz; this requirement may be fulfilled by the satellite EPIRB, required by regulation 7.1.6, either by installing the satellite EPIRB close to, or by remote activation from, the position from which the ship is normally navigated; or
 - 1.4.2. on HF using DSC; or
 - 1.4.3. through the INMARSAT geostationary satellite service by an additional ship earth station.

Alternative 2

2. In addition to meeting the requirements of regulation 7, every ship engaged on voyages beyond sea areas A1 and A2, but remaining within sea area A3, shall, if it does not comply with the requirements of paragraph 1, be provided with:
 - 2.1. an MF/HF radio installation capable of transmitting and receiving, for distress and safety purposes, on all distress and safety frequencies in the bands between 1,605 kHz and 4,000 kHz and between 4,000 kHz and 27,500 kHz:
 - 2.1.1. using DSC;
 - 2.1.2. using radiotelephony; and
 - 2.1.3. using direct-printing telegraphy; and

- 2.2. equipment capable of maintaining DSC watch on 2,187.5 kHz, 8,414.5 kHz and on at least one of the distress and safety DSC frequencies 4,207.5 kHz, 6,312 kHz, 12,577 kHz or 16,804.5 kHz; at any time, it shall be possible to select any of these DSC distress and safety frequencies. This equipment may be separate from, or combined with, the equipment required by subparagraph .1; and
- 2.3. means of initiating the transmission of ship-to-shore distress alerts by a radiocommunication service other than HF operating either:
 - 2.3.1. through the polar orbiting satellite service on 406 MHz; this requirement may be fulfilled by the satellite EPIRB, required by regulation 7.1.6, either by installing the satellite EPIRB close to, or by remote activation from, the position from which the ship is normally navigated; or
 - 2.3.2. through the INMARSAT geostationary satellite service by a ship earth station; and:
 - 2.3.2.1. an INMARSAT ship earth station; or
 - 2.3.2.2. the satellite EPIRB, required by regulation 7.1.6, either by installing the satellite EPIRB close to, or by remote activation from, the position from which the ship is normally navigated; and
- 2.4. in addition, ships shall be capable of transmitting and receiving general radiocommunications using radiotelephony or direct-printing telegraphy by an MF/HF radio installation operating on working frequencies in the bands between 1,605 kHz and 4,000 kHz and between 4,000 kHz and 27,500 kHz. This requirement may be fulfilled by the addition of this capability in the equipment required by subparagraph .1.

The requirement for direct-printing telegraphy equipment in regulation 10.2.1.3 shall not apply to cargo ships with a gross tonnage below 300.

3. It shall be possible to initiate transmission of distress alerts by the radio installations specified in paragraphs 1.1, 1.2, 1.4, 2.1 and 2.3 from the position from which the ship is normally navigated.
4. The Administration may exempt ships constructed before 1 February 1997, and engaged exclusively on voyages within sea areas A2 and A3, from the requirements of regulations 7.1.1.1 and 7.1.2 provided such ships maintain, when practicable, a continuous listening watch on VHF channel 16. This watch shall be kept at the position from which the ship is normally navigated.

Regulation 11 – Radio equipment: Sea areas A1, A2, A3 and A4

1. In addition to meeting the requirements of regulation 7, ships engaged on voyages in all sea areas shall be provided with the radio installations and equipment required by regulation 10.2 (MF/HF – alternative 2), except that the equipment required by regulation 10.2.3.2 (Inmarsat) shall not be accepted as an alternative to that required by regulation 10.2.3.1 (406 MHz), which shall always be provided. In addition, ships engaged on voyages in all sea areas shall comply with the requirements of regulation 10.3.

The requirement for direct-printing telegraphy equipment shall not apply to cargo ships with a gross tonnage below 300.

2. The Administration may exempt ships constructed before 1 February 1997, and engaged exclusively on voyages within sea areas A2, A3 and A4, from the requirements of regulations 7.1.1.1 and 7.1.2 provided such ships maintain, when practicable, a continuous listening watch on VHF channel 16. This watch shall be kept at the position from which the ship is normally navigated.

Regulation 12 – Watches

1. Every ship, while at sea, shall maintain a continuous watch:
 - 1.1. on VHF DSC channel 70, if the ship, in accordance with the requirements of regulation 7.1.2, is fitted with a VHF radio installation;
 - 1.2. on the distress and safety DSC frequency 2,187.5 kHz, if the ship, in accordance with the requirements of regulation 9.1.2 or 10.1.3, is fitted with an MF radio installation;
 - 1.3. on the distress and safety DSC frequencies 2,187.5 kHz and 8,414.5 kHz and also on at least one of the distress and safety DSC frequencies 4,207.5 kHz, 6,312 kHz, 12,577 kHz or 16,804.5 kHz, appropriate to the time of day and the geographical position of the ship, if the ship, in accordance with the requirements of regulation 10.2.2 or 11.1, is fitted with an MF/HF radio installation. This watch may be kept by means of a scanning receiver;
 - 1.4. for satellite shore-to-ship distress alerts, if the ship, in accordance with the requirements of regulation 10.1.1, is fitted with an INMARSAT ship earth station.
2. Every ship, while at sea, shall maintain a radio watch for broadcasts of maritime safety information on the appropriate frequency or frequencies on which such information is broadcast for the area in which the ship is navigating.
3. Until 1 February 1999¹⁸ or until such other date as may be determined by the Maritime Safety Committee, every ship while at sea shall maintain, when practicable, a continuous listening watch on VHF channel 16. This watch shall be kept at the position from which the ship is normally navigated.

Regulation 13 – Sources of energy

1. There shall be available at all times, while the ship is at sea, a supply of electrical energy sufficient to operate the radio installations and to charge any batteries used as part of a reserve source or sources of energy for the radio installations.
2. A reserve source or sources of energy shall be provided on every ship, to supply radio installations, for the purpose of conducting distress and safety radiocommunications, in the event of failure of the ship's main and emergency sources of electrical power. The reserve source or sources of energy shall be capable of simultaneously operating the VHF radio installation required by regulation 7.1.1 and, as appropriate for the sea area or sea areas for which the ship is equipped, either the MF radio installation required by regulation 9.1.1, the MF/HF radio installation required by regulation 10.2.1 or 11.1, or the INMARSAT ship earth station required by regulation 10.1.1 and any of the additional loads mentioned in paragraphs 4, 5 and 8 for a period of at least:
 - 2.1 1 h on ships provided with an emergency source of electrical power, if such source of power complies fully with all relevant provisions of regulation II-1/42 or 43, including the supply of such power to the radio installations; and
 - 2.2 6 h on ships not provided with an emergency source of electrical power complying fully with all relevant provisions of regulation II-1/42 or 43, including the supply of such power to the radio installations¹⁹.

¹⁸ The Maritime Safety Committee decided (resolution MSC.131(75)) that all GMDSS ships, while at sea, shall continue to maintain, when practicable, continuous listening watch on VHF channel 16.

¹⁹ For guidance, the following formula is recommended for determining the electrical load to be supplied by the reserve source of energy for each radio installation required for distress conditions: 1/2 of the current consumption necessary for transmission + the current consumption necessary for reception + the current consumption of any additional loads.

The reserve source or sources of energy need not supply independent HF and MF radio installations at the same time.

3. The reserve source or sources of energy shall be independent of the propelling power of the ship and the ship's electrical system.
4. Where, in addition to the VHF radio installation, two or more of the other radio installations, referred to in paragraph 2, can be connected to the reserve source or sources of energy, they shall be capable of simultaneously supplying, for the period specified, as appropriate, in paragraph 2.1 or 2.2, the VHF radio installation and:
 - 4.1 all other radio installations which can be connected to the reserve source or sources of energy at the same time; or
 - 4.2 whichever of the other radio installations will consume the most power, if only one of the other radio installations can be connected to the reserve source or sources of energy at the same time as the VHF radio installation.
5. the reserve source or sources of energy may be used to supply the electrical lighting required by regulation 6.2.4.
6. Where a reserve source of energy consists of a rechargeable accumulator battery or batteries:
 - 6.1 a means of automatically charging such batteries shall be provided which shall be capable of recharging them to minimum capacity requirements within 10 h; and
 - 6.2 the capacity of the battery or batteries shall be checked, using an appropriate method²⁰, at intervals not exceeding 12 months, when the ship is not at sea.
7. The siting and installation of accumulator batteries which provide a reserve source of energy shall be such as to ensure:
 - 7.1 the highest degree of service;
 - 7.2 a reasonable lifetime;
 - 7.3 reasonable safety;
 - 7.4 that battery temperatures remain within the manufacturer's specifications whether under charge or idle; and
 - 7.5 that when fully charged, the batteries will provide at least the minimum required hours of operation under all weather conditions.
8. If an uninterrupted input of information from the ship's navigational or other equipment to a radio installation required by this chapter, including the navigation receiver referred to in regulation 18, is needed to ensure its proper performance, means shall be provided to ensure the continuous supply of such information in the event of failure of the ship's main or emergency source of electrical power.
9. *The lighting required in regulation 6.2.4 and navigational equipment that is connected to the radio equipment of the ship shall be connected to the same source of power as the radio equipment.*

Regulation 14 – Performance standards

1. All equipment to which this chapter applies shall be of a type approved by the Administration. Such equipment shall conform to appropriate performance standards not inferior to those adopted by the Organization.

²⁰ One method of checking the capacity of an accumulator battery is to fully discharge and recharge the battery, using normal operating current and period (e.g. 10 h). Assessment of the charge condition can be made at any time, but it should be done without significant discharge of the battery when the ship is at sea.

In cargo ships with a gross tonnage below 300 engaged on voyages in sea areas A1 and A2, the VHF-DSC equipment may be of class A, B or D and the MF-DSC equipment may be of class A, B or E.

2. *The radio equipment in this chapter and in chapter III, regulation 6.2, shall comply with the requirements of Council Directive 96/98/EC of 20 December 1996 on marine equipment.*
3. *The radio equipment in cargo ships with a gross tonnage below 300 shall be exempted from the requirement in regulation 14.2 if the requirements of Council Directive 99/5/EC of 9 March 1999 on radio equipment and telecommunications terminal equipment (R&TTE) have been complied with.*

Regulation 15 – Maintenance requirements

1. Equipment shall be so designed that the main units can be replaced readily, without elaborate recalibration or readjustment.
2. Where applicable, equipment shall be so constructed and installed that it is readily accessible for inspection and on-board maintenance purposes.
3. Adequate information shall be provided to enable the equipment to be properly operated and maintained, taking into account the recommendations of the Organization.²¹
4. Adequate tools and spares shall be provided to enable the equipment to be maintained.
5. The Administration shall ensure that radio equipment required by this chapter is maintained to provide the availability of the functional requirements specified in regulation 4 and to meet the recommended performance standards of such equipment.
6. On ships engaged on voyages in sea areas A1 and A2, the availability shall be ensured by using such methods as duplication of equipment, shore-based maintenance or at-sea electronic maintenance capability, or a combination of these, as may be approved by the Administration. *Cargo ships engaged on international voyages with a gross tonnage below 300 and cargo ships engaged on domestic voyages shall be exempted from this requirement.*
7. On ships engaged on voyages in sea areas A3 and A4, the availability shall be ensured by using a combination of at least two methods such as duplication of equipment, shore-based maintenance or at-sea electronic maintenance capability, as may be approved by the Administration, taking into account the recommendations of the Organization.²² *For cargo ships with a gross tonnage below 300, the number of maintenance methods may, however, be reduced to at least one.*
8. While all reasonable steps shall be taken to maintain the equipment in efficient working order to ensure compliance with all the functional requirements specified in regulation 4, malfunction of the equipment for providing the general radiocommunications required by regulation 4.8 shall not be considered as making a ship unseaworthy or as a reason for delaying the ship in ports where repair facilities are not readily available, provided the ship is capable of performing all distress and safety functions.
9. Satellite EPIRBs shall be:

²¹ Refer to the Recommendation on general requirements for shipborne radio equipment forming part of the global maritime distress and safety system and for electronic navigational aids adopted by the Organization by resolution A.694(17) and to resolution A.813(19) on general requirements for electromagnetic compatibility (EMC) for all electrical and electronic ship's equipment as well as to MSC/Circ.862 on specific requirements for IMO performance standards for GMDSS equipment.

²² Refer to resolution A.702(17) concerning radio maintenance guidelines for the global maritime distress and safety system related to sea areas A3 and A4.

- .1 annually tested for all aspects of operational efficiency, with special emphasis on checking the emission on operational frequencies, coding and registration, at intervals as specified below:
 - .1 on passenger ships, within 3 months before the expiry date of the Passenger Ship Safety Certificate; and
 - .2 on cargo ships, within 3 months before the expiry date, or 3 months before or after the anniversary date, of the Cargo Ship Safety Radio Certificate.The test may be conducted on board the ship or at an approved testing station; and
- .2 subject to maintenance at intervals not exceeding five years, to be performed at an approved shore-based maintenance facility.

Regulation 16 – Radio personnel

1. Every ship shall carry personnel qualified for distress and safety radiocommunication purposes to the satisfaction of the Administration²³. The personnel shall be holders of certificates specified in the Radio Regulations as appropriate, any one of whom shall be designated to have primary responsibility for radiocommunications during distress incidents.
2. In passenger ships, at least one person qualified in accordance with paragraph 1 shall be assigned to perform only radiocommunication duties during distress incidents.

Regulation 17 – Radio records

A *radio* record shall be kept, to the satisfaction of the Administration and as required by the Radio Regulations, of all incidents connected with the radiocommunication service which appear to be of importance to safety of life at sea. *The information may be entered in the ship's log book or in a radio log. If the information is entered in the ship's log book, it shall be stated on the front page of the ship's log book.*

Regulation 18 – Position updating

All two-way communication equipment carried on board a ship to which this chapter applies which is capable of automatically including the ship's position in the distress alert shall be automatically provided with this information from an internal or external navigation receiver, if either is installed. If such a receiver is not installed, the ship's position and the time at which the position was determined shall be manually updated at intervals not exceeding 4 h, while the ship is under way, so that it is always ready for transmission by the equipment.

²³ Refer to the STCW Code, chapter IV, section B-IV/2.

Notice from the Danish Maritime Authority B – The Construction and Equipment, etc. of Ships

Chapter B V

Safety of Navigation

Regulation 1 – Application	2
Regulation 2 – Definitions	2
Regulation 3 – Exemptions and equivalents	3
Regulation 4 – Navigational warnings	3
Regulation 5 – Meteorological services and warnings	3
Regulation 6 – Ice Patrol Service	5
Regulation 7 – Search and rescue services	6
Regulation 8 – Life-saving signals	6
Regulation 9 – Hydrographic services	6
Regulation 10 – Ships' routeing	7
Regulation 11 – Ship reporting systems	8
Regulation 12 – Vessel traffic services	9
Regulation 13 – Establishment and operation of aids to navigation	9
Regulation 14 – Ships' manning	10
Regulation 15 – Principles relating to bridge design, design and arrangement of navigational systems and equipment and bridge procedures	10
Regulation 16 – Maintenance of equipment	11
Regulation 17 – Electromagnetic compatibility	11
Regulation 18 – Approval, surveys and performance standards of navigational systems and equipment and voyage data recorder	11
Regulation 19 – Carriage requirements for shipborne navigational systems and equipment	13
Regulation 19-1 – Long-range identification and tracking of ships	17
Regulation 20 – Voyage data recorders	19
Regulation 21 – International Code of Signals and IAMSAR Manual	20
Regulation 22 – Navigation bridge visibility	20
Regulation 23 – Pilot transfer arrangements	22
Regulation 24 – Use of heading and/or track control systems	24
Regulation 25 – Operation of steering gear	24
Regulation 26 – Steering gear: testing and drills	24
Regulation 27 – Nautical charts and nautical publications	25
Regulation 28 – Records of navigational activities and daily reporting	25
Regulation 29 – Life-saving signals to be used by ships, aircraft or persons in distress	26
Regulation 30 – Operational limitations	26
Regulation 31 – Danger messages	26
Regulation 32 – Information required in danger messages	27

Regulation 33 – Distress messages: obligations and procedures	29
Regulation 34 – Safe navigation and avoidance of dangerous situations	30
Regulation 34-1 Master's discretion.....	30
Regulation 35 – Misuse of distress signals	30
Regulation 36 – Navigation lights, shapes and sound signals.....	30

Regulation 1 – Application

1. Unless expressly provided otherwise, this chapter shall apply to all ships on all voyages, except:
 - 1.1. warships, naval auxiliaries and other ships owned or operated by a Contracting Government and used only on Government non-commercial service; and
 - 1.2. ships solely navigating the Great Lakes of North America and their connecting and tributary waters as far east as the lower exit of the St. Lambert Lock at Montreal in the Province of Quebec, Canada.

However, warships, naval auxiliaries or other ships owned or operated by a Contracting Government and used only on Government non-commercial service are encouraged to act in a manner consistent, so far as reasonable and practicable, with this chapter.

2. The Administration may decide to what extent this chapter shall apply to ships operating solely in waters landward of the baselines which are established in accordance with international law.
3. A rigidly connected composite unit of a pushing vessel and associated pushed vessel, when designed as a dedicated and integrated tug and barge combination, shall be regarded as a single ship for the purpose of this chapter.
4. The Administration shall determine to what extent the provisions of regulations 15, 16, 17, 18, 19, 20, 21, 22, 23, 24, 25, 26, 27 and 28 do not apply to the following categories of ships:
 - 4.1. ships below 150 gross tonnage engaged on any voyage;
 - 4.2. ships below 500 gross tonnage not engaged on international voyages; and
 - 4.3. fishing vessels.
5. *Though, for the purpose of this chapter, the Convention covers all ships, irrespective of size and area of navigation, the requirements for equipment in regulations 15, 17, 18, 19, 20, 21, 22, 23, 24, 27, 29 and 36 in this chapter shall apply only to cargo ships with a length (L) of or above 15 metres, respectively a scantling number¹⁾ of or above 100 as well as passenger ships, irrespective of size, when engaged on international voyages. As to the requirements for equipment on ships other than those referred to above, reference is made to the regulations applying to the ships in question.²⁾*

Regulation 2 – Definitions

For the purpose of this chapter:

1. “Constructed” in respect of a ship means a stage of construction where:
 - 1.1. the keel is laid; or
 - 1.2. construction identifiable with a specific ship begins; or
 - 1.3. assembly of the ship has commenced comprising at least 50 tonnes or 1% of the estimated mass of all structural material, whichever is less.

¹⁾ Cf. the definition in regulation I/2.

²⁾ At present, Notices from the Danish Maritime Authority D, E and F.

2. "Nautical chart or nautical publication" is a special purpose map or book, or a specially compiled database from which such a map or book is derived, that is issued officially by or on the authority of a Government, authorized Hydrographic Office or other relevant government institution and is designed to meet the requirements of marine navigation.³⁾
3. "All ships" means any ship, vessel or craft irrespective of type and purpose.
4. Length of a ship means its length overall.
5. "Search and rescue service". The performance of distress monitoring, communication, co-ordination and search and rescue functions, including provision of medical advice, initial medical assistance, or medical evacuation, through the use of public and private resources including cooperating aircraft, ships, vessels and other craft and installations.
6. High-speed craft means a craft as defined in regulation X/1.3.
7. "Mobile offshore drilling unit" means a mobile offshore drilling unit as defined in regulation XI-2/1.1.5.

Regulation 3 – Exemptions and equivalents

1. The Administration may grant general exemptions from the requirements of regulations 15, 17, 18, 19 (except 19.2.1.7), 20, 22, 24, 25, 26, 27 and 28 to ships without mechanical means of propulsion.
2. The Administration may grant to individual ships exemptions or equivalents of a partial or conditional nature, when any such ship is engaged on a voyage where the maximum distance of the ship from the shore, the length and nature of the voyage, the absence of general navigational hazards, and other conditions affecting safety are such as to render the full application of this chapter unreasonable or unnecessary, provided that the Administration has taken into account the effect such exemptions and equivalents may have upon the safety of all other ships.
3. Each Administration shall submit to the Organization, as soon as possible after 1 January in each year, a report summarizing all new exemptions and equivalents granted under paragraph 2 of this regulation during the previous calendar year and giving the reasons for granting such exemptions and equivalents. The Organization shall circulate such particulars to other Contracting Governments for information.

Regulation 4 – Navigational warnings

Each Contracting Government shall take all steps necessary to ensure that, when intelligence of any dangers is received from whatever reliable source, it shall be promptly brought to the knowledge of those concerned and communicated to other interested Governments.⁴⁾

Regulation 5 – Meteorological services and warnings

1. Contracting Governments undertake to encourage the collection of meteorological data by ships at sea and to arrange for their examination, dissemination and exchange in the manner most suitable for the purpose of aiding navigation.⁵⁾ Administrations shall encourage the use of meteorological instruments of a high degree of accuracy and shall facilitate the checking of such instruments upon

³⁾ Refer to appropriate resolutions and recommendations of the International Hydrographic Organization concerning the authority and responsibilities of coastal States in the provision of charting in accordance with regulation 9.

⁴⁾ Refer to the Guidance on the IMO/IHO World-Wide Navigational Warning Service adopted by the Organization by resolution A.706(17), as amended

⁵⁾ Refer to the Recommendation on weather routing adopted by the Organization by resolution A.528(13).

request. Arrangements may be made by appropriate national meteorological services for this checking to be undertaken, free of charge to the ship.

2. In particular, Contracting Governments undertake to carry out, in co-operation, the following meteorological arrangements:
 - 2.1. To warn ships of gales, storms and tropical cyclones by the issue of information in text and, as far as practicable, graphic form, using the appropriate shore-based facilities for terrestrial and space radiocommunications services.
 - 2.2. To issue, at least twice daily, by terrestrial and space radiocommunication services⁶⁾, as appropriate, weather information suitable for shipping containing data, analyses, warnings and forecasts of weather, waves and ice. Such information shall be transmitted in text and, as far as practicable, graphic form, including meteorological analysis and prognosis charts transmitted by facsimile or in digital form for reconstitution on board the ship's data processing system.
 - 2.3. To prepare and issue such publications as may be necessary for the efficient conduct of meteorological work at sea and to arrange, if practicable, for the publication and making available of daily weather charts for the information of departing ships.
 - 2.4. To arrange for a selection of ships to be equipped with tested marine meteorological instruments (such as a barometer, a barograph, a psychrometer and suitable apparatus for measuring sea temperature) for use in this service, and to take, record and transmit meteorological observations at the main standard times for surface synoptic observations (i.e. at least four times daily, whenever circumstances permit) and to encourage other ships to take, record and transmit observations in a modified form, particularly when in areas where shipping is sparse.
 - 2.5. To encourage companies to involve as many of their ships as practicable in the making and recording of weather observations; these observations to be transmitted using the ship's terrestrial or space radiocommunications facilities for the benefit of the various national meteorological services.
 - 2.6. The transmission of these weather observations is free of charge to the ships concerned.
 - 2.7. When in the vicinity of a tropical cyclone, or of a suspected tropical cyclone, ships should be encouraged to take and transmit their observations at more frequent intervals whenever practicable, bearing in mind navigational preoccupations of ships' officers during storm conditions.
 - 2.8. To arrange for the reception and transmission of weather messages from and to ships, using the appropriate shorebased facilities for terrestrial and space radiocommunications services.
 - 2.9. To encourage masters to inform ships in the vicinity and also shore stations whenever they experience a wind speed of 50 knots or more (force 10 on the Beaufort scale) (25 m/sec.).
 - 2.10. To endeavour to obtain a uniform procedure in regard to the international meteorological services already specified, and as far as practicable, to conform to the technical regulations and recommendations made by the World Meteorological Organization, to which Contracting Governments may refer, for study and advice, any meteorological question which may arise in carrying out the present Convention.
 - 2.11. *Any master of a Danish ship may be ordered, by the reception and transmission of meteorological observations, to contribute to the maintenance of meteorological services to*

⁶⁾ Refer to regulations IV/7.1.4 and IV/7.1.5.

the degree necessary for the safety of navigation. The prescribed reports shall be submitted to the Danish authorities without any costs for the ship in question.

3. The information provided for in this regulation shall be furnished in a form for transmission and be transmitted in the order of priority prescribed by the Radio Regulations. During transmission "to all stations" of meteorological information, forecasts and warnings, all ship stations must conform to the provisions of the Radio Regulations.
4. Forecasts, warnings, synoptic and other meteorological data intended for ships shall be issued and disseminated by the national meteorological service in the best position to serve various coastal and high seas areas, in accordance with mutual arrangements made by Contracting Governments, in particular as defined by the World Meteorological Organization's system for the preparation and dissemination of meteorological forecasts and warnings for the high seas under the global maritime distress and safety system (GMDSS).

Regulation 6 – Ice Patrol Service

1. The Ice Patrol contributes to safety of life at sea, safety and efficiency of navigation and protection of the marine environment in the North Atlantic. Ships transiting the region of icebergs guarded by the Ice Patrol during the ice season are required to make use of the services provided by the Ice Patrol.
2. The Contracting Governments undertake to continue an ice patrol and a service for study and observation of ice conditions in the North Atlantic. During the whole of the ice season, i.e., for the period from 15 February through 1 July of each year, the south-eastern, southern and south-western limits of the region of icebergs in the vicinity of the Grand Banks of Newfoundland shall be guarded for the purpose of informing passing ships of the extent of this dangerous region; for the study of ice conditions in general; and for the purpose of affording assistance to ships and crews requiring aid within the limits of operation of the patrol ships and aircraft. During the rest of the year the study and observation of ice conditions shall be maintained as advisable.
3. Ships and aircraft used for the Ice Patrol Service and the study and observation of ice conditions may be assigned other duties provided that such other duties do not interfere with the primary purpose or increase the cost of this service.
4. The Government of the United States of America agrees to continue the overall management of the Ice Patrol Service and the study and observation of ice conditions, including the dissemination of information there from.
5. The terms and conditions governing the management, operation and financing of the Ice Patrol are set forth in the Rules for the management, operation and financing of the North Atlantic Ice Patrol appended to this chapter, which shall form an integral part of this chapter.
6. If, at any time, the United States and/or Canadian Governments should desire to discontinue providing these services, it may do so and the Contracting Governments shall settle the question of continuing these services in accordance with their mutual interests. The United States and/or Canadian Governments shall provide 18 months' written notice to all Contracting Governments whose ships entitled to fly their flag and whose ships are registered in territories to which those Contracting Governments have extended this regulation benefit from these services before discontinuing providing these services.

Regulation 7 – Search and rescue services

1. Each Contracting Government undertakes to ensure that necessary arrangements are made for distress communication and co-ordination in their area of responsibility and for the rescue of persons in distress at sea around its coasts. These arrangements shall include the establishment, operation and maintenance of such search and rescue facilities as are deemed practicable and necessary, having regard to the density of the seagoing traffic and the navigational dangers, and shall, so far as possible, provide adequate means of locating and rescuing such persons.⁷⁾
2. Each Contracting Government undertakes to make available information to the Organization concerning its existing search and rescue facilities and the plans for changes therein, if any.
3. Passenger ships to which chapter I applies shall have on board a plan for co-operation with appropriate search and rescue services in the event of an emergency. The plan shall be developed in co-operation between the ship, the company, as defined in regulation IX/1, and the search and rescue services. The plan shall include provisions for periodic exercises to be undertaken to test its effectiveness. The plan shall be developed based on the guidelines developed by the Organization.

Regulation 8 – Life-saving signals

Contracting Governments undertake to arrange that lifesaving signals are used by search and rescue facilities engaged in search and rescue operations when communicating with ships or persons in distress.

Regulation 9 – Hydrographic services

1. Contracting Governments undertake to arrange for the collection and compilation of hydrographic data and the publication, dissemination and keeping up to date of all nautical information necessary for safe navigation.
2. In particular, Contracting Governments undertake to co-operate in carrying out, as far as possible, the following nautical and hydrographic services, in the manner most suitable for the purpose of aiding navigation:
 - 2.1. to ensure that hydrographic surveying is carried out, as far as possible, adequate to the requirements of safe navigation;
 - 2.2. to prepare and issue nautical charts, sailing directions, lists of lights, tide tables and other nautical publications, where applicable, satisfying the needs of safe navigation;
 - 2.3. to promulgate notices to mariners in order that nautical charts and publications are kept, as far as possible, up to date; and
 - 2.4. to provide data management arrangements to support these services.
3. Contracting Governments undertake to ensure the greatest possible uniformity in charts and nautical publications and to take into account, whenever possible, relevant international resolutions and recommendations.⁸⁾

⁷⁾ Refer to the following International Convention on Maritime Search and Rescue (SAR), 1979, and to the following resolutions adopted by the Organization: Homing capability of search and rescue (SAR) aircraft (resolution A.225(VII)), Use of radar transponders for search and rescue purposes (resolution A.530(13)), Search and rescue homing capability (resolution A.616(15)) and International Aeronautical and Maritime Search and Rescue (IAMSAR) Manual (resolution A.892(21)).

⁸⁾ Refer to the appropriate resolutions and recommendations adopted by the International Hydrographic Organization.

4. Contracting Governments undertake to co-ordinate their activities to the greatest possible degree in order to ensure that hydrographic and nautical information is made available on a world-wide scale as timely, reliably, and unambiguously as possible.

Regulation 10 – Ships' routing

1. Ships' routing systems contribute to safety of life at sea, safety and efficiency of navigation and/or protection of the marine environment. Ships' routing systems are recommended for use by, and may be made mandatory for, all ships, certain categories of ships or ships carrying certain cargoes, when adopted and implemented in accordance with the guidelines and criteria developed by the Organization.⁹⁾
2. The Organization is recognized as the only international body for developing guidelines, criteria and regulations on an international level for ships' routing systems. Contracting Governments shall refer proposals for the adoption of ships' routing systems to the Organization. The Organization will collate and disseminate to Contracting Governments all relevant information with regard to any adopted ships' routing systems.
3. The initiation of action for establishing a ships' routing system is the responsibility of the Government or Governments concerned. In developing such systems for adoption by the Organization, the guidelines and criteria developed by the Organization shall be taken into account.
4. Ships' routing systems should be submitted to the Organization for adoption. However, a Government or Governments implementing ships' routing systems not intended to be submitted to the Organization for adoption or which have not been adopted by the Organization are encouraged to take into account, wherever possible, the guidelines and criteria developed by the Organization.¹⁰⁾
5. Where two or more Governments have a common interest in a particular area, they should formulate joint proposals for the delineation and use of a routing system therein on the basis of an agreement between them. Upon receipt of such proposal and before proceeding with consideration of it for adoption, the Organization shall ensure that details of the proposal are disseminated to the Governments which have a common interest in the area, including countries in the vicinity of the proposed ships' routing system.
6. Contracting Governments shall adhere to the measures adopted by the Organization concerning ships' routing. They shall promulgate all information necessary for the safe and effective use of adopted ships' routing systems. A Government or Governments concerned may monitor traffic in those systems. Contracting Governments shall do everything in their power to secure the appropriate use of ships' routing systems adopted by the Organization.
7. A ship shall use a mandatory ships' routing system adopted by the Organization as required for its category or cargo carried and in accordance with the relevant provisions in force unless there are compelling reasons not to use a particular ships' routing system. Any such reason shall be recorded in the ships' log.
8. Mandatory ships' routing systems shall be reviewed by the Contracting Government or Governments concerned in accordance with the guidelines and criteria developed by the Organization.

⁹⁾ Refer to the General provisions on ships' routing adopted by the Organization by resolution A.572(14), as amended.

¹⁰⁾ Refer to the General provisions on ships' routing adopted by the Organization by resolution A.572(14), as amended.

9. All adopted ships' routeing systems and actions taken to enforce compliance with those systems shall be consistent with international law, including the relevant provisions of the 1982 United Nations Convention on the Law of the Sea.
10. Nothing in this regulation nor its associated guidelines and criteria shall prejudice the rights and duties of Governments under international law or the legal regimes of straits used for international navigation and archipelagic sea lanes.¹¹⁾

Regulation 11 – Ship reporting systems¹²⁾

1. Ship reporting systems contribute to safety of life at sea, safety and efficiency of navigation and/or protection of the marine environment. A ship reporting system, when adopted and implemented in accordance with the guidelines and criteria developed by the Organization pursuant to this regulation, shall be used by all ships or certain categories of ships or ships carrying certain cargoes in accordance with the provisions of each system so adopted.
2. The Organization is recognized as the only international body for developing guidelines, criteria and regulations on an international level for ship reporting systems. Contracting Government shall refer proposals for the adoption of ship reporting systems to the Organization. The Organization will collate and disseminate to Contracting Governments all relevant information with regard to any adopted ship reporting system.
3. The initiation of action for establishing a ship reporting system is the responsibility of the Government or Governments concerned. In developing such systems, provision of the guidelines and criteria developed by the Organization¹³⁾ shall be taken into account.
4. Ship reporting systems not submitted to the Organization for adoption do not necessarily need to comply with this regulation. However, Governments implementing such systems are encouraged to follow, wherever possible, the guidelines and criteria developed by the Organization¹³⁾. Contracting Governments may submit such systems to the Organization for recognition.
5. Where two or more Governments have a common interest in a particular area, they should formulate proposals for a co-ordinated ship reporting system on the basis of agreement between them. Before proceeding with a proposal for adoption of a ship reporting system, the Organization shall disseminate details of the proposal to those Governments which have a common interest in the area covered by the proposed system. Where a co-ordinated ship reporting system is adopted and established, it shall have uniform procedures and operations.
6. After adoption of a ship reporting system in accordance with this regulation, the Government or Governments concerned shall take all measures necessary for the promulgation of any information needed for the efficient and effective use of the system. Any adopted ship reporting system shall have the capability of interaction and the ability to assist ships with information when necessary. Such systems shall be operated in accordance with the guidelines and criteria developed by the Organization¹⁴⁾ pursuant to this regulation.

¹¹⁾ Archipelago, sea with many islets (e.g. the Indonesian Archipelago).

¹²⁾ This regulation does not address ship reporting systems established by Governments for search and rescue purposes, which are covered by chapter 5 of the 1979 SAR Convention, as amended.

¹³⁾ Refer to the Guidelines and criteria adopted by the Maritime Safety Committee of the Organization by resolution MSC.43(64), as amended by resolution MSC.111 (73). Refer also to the General principles for ship reporting systems and ship reporting requirements, including guidelines for reporting incidents involving dangerous goods, harmful substances and/or marine pollutants, adopted by the Organization by resolution A.851(20).

¹⁴⁾ Refer to the Guidelines on vessel traffic services adopted by the Organization by resolution A.857(20).

7. The master of a ship shall comply with the requirements of adopted ship reporting systems and report to the appropriate authority all information required in accordance with the provisions of each such system.
8. All adopted ship reporting systems and actions taken to enforce compliance with those systems shall be consistent with international law, including the relevant provisions of the United Nations Convention on the Law of the Sea.
9. Nothing in this regulation or its associated guidelines and criteria shall prejudice the rights and duties of Governments under international law or the legal regimes of straits used for international navigation and archipelagic sea lanes.
10. The participation of ships in accordance with the provisions of adopted ship reporting systems shall be free of charge to the ships concerned.
11. The Organization shall ensure that adopted ship reporting systems are reviewed under the guidelines and criteria developed by the Organization.

Regulation 12 – Vessel traffic services

1. Vessel traffic services (VTS) contribute to safety of life at sea, safety and efficiency of navigation and protection of the marine environment, adjacent shore areas, work sites and offshore installations from possible adverse effects of maritime traffic.
2. Contracting Governments undertake to arrange for the establishment of VTS where, in their opinion, the volume of traffic or the degree of risk justifies such services.
3. Contracting Governments planning and implementing VTS shall, wherever possible, follow the guidelines developed by the Organization¹⁵⁾. The use of VTS may only be made mandatory in sea areas within the territorial seas of a coastal State.
4. Contracting Governments shall endeavour to secure the participation in, and compliance with, the provisions of vessel traffic services by ships entitled to fly their flag.
5. Nothing in this regulation or the guidelines adopted by the Organization shall prejudice the rights and duties of Governments under international law or the legal regimes of straits used for international navigation and archipelagic sea lanes.

Regulation 13 – Establishment and operation of aids to navigation

1. Each Contracting Government undertakes to provide, as it deems practical and necessary, either individually or in co-operation with other Contracting Governments, such aids to navigation as the volume of traffic justifies and the degree of risk requires.
2. In order to obtain the greatest possible uniformity in aids to navigation, Contracting Governments undertake to take into account the international recommendations and guidelines¹⁶⁾ when establishing such aids.
3. Contracting Governments undertake to arrange for information relating to aids to navigation to be made available to all concerned. Changes in the transmissions of position-fixing systems which could adversely affect the performance of receivers fitted in ships shall be avoided as far as possible and only be effected after timely and adequate notice has been promulgated.

¹⁵⁾ Refer to the Guidelines on vessel traffic services adopted by the Organization by resolution A.857(20).

¹⁶⁾ Refer to the appropriate Recommendations and guidelines of IALA and to SN/Circ.107, Maritime buoyage system.

Regulation 14 – Ships' manning

1. Contracting Governments undertake, each for its national ships, to maintain, or, if it is necessary, to adopt, measures for the purpose of ensuring that, from the point of view of safety of life at sea, all ships shall be sufficiently and efficiently manned.¹⁷⁾
2. Every ship to which chapter I applies shall be provided with an appropriate minimum safe manning document or equivalent issued by the Administration as evidence of the minimum safe manning considered necessary to comply with the provisions of paragraph 1.
3. On all ships, to ensure effective crew performance in safety matters, a working language shall be established and recorded in the ship's log-book. The company, as defined in regulation IX/1, or the master, as appropriate, shall determine the appropriate working language. Each seafarer shall be required to understand and, where appropriate, give orders and instructions and to report back in that language. If the working language is not an official language of the State whose flag the ship is entitled to fly, all plans and lists required to be posted shall include a translation into the working language.
4. On ships to which chapter I applies, English shall be used on the bridge as the working language for bridge-to-bridge and bridge-to-shore safety communications as well as for communications on board between the pilot and bridge watch-keeping personnel¹⁸⁾, unless those directly involved in the communication speak a common language other than English.

Regulation 15 – Principles relating to bridge design, design and arrangement of navigational systems and equipment and bridge procedures

All decisions which are made for the purpose of applying the requirements of regulations 19, 22, 24, 25, 27 and 28 and which affect bridge design, the design and arrangement of navigational systems and equipment on the bridge and bridge procedures¹⁹⁾ shall be taken with the aim of:

- 1.1. facilitating the tasks to be performed by the bridge team and the pilot in making full appraisal of the situation and in navigating the ship safely under all operational conditions;
- 1.2. promoting effective and safe bridge resource management;
- 1.3. enabling the bridge team and the pilot to have convenient and continuous access to essential information which is presented in a clear and unambiguous manner, using standardized symbols and coding systems for controls and displays;
- 1.4. indicating the operational status of automated functions and integrated components, systems and/or sub-systems;
- 1.5. allowing for expeditious, continuous and effective information processing and decision-making by the bridge team and the pilot;
- 1.6. preventing or minimizing excessive or unnecessary work and any conditions or distractions on the bridge which may cause fatigue or interfere with the vigilance of the bridge team and the pilot; and
- 1.7. minimizing the risk of human error and detecting such error, if it occurs, through monitoring and alarm systems, in time for the bridge team and the pilot to take appropriate action.

¹⁷⁾ Refer to the Principles of safe manning adopted by the Organization by resolution A.890(21) as amended by A.955(23).

¹⁸⁾ The IMO Standard Marine Communication Phrases (resolution A.918(22)), as amended, may be used in this respect.

¹⁹⁾ Refer to the Guidelines on ergonomic criteria for bridge equipment and layout (MSC/Circ.982) and the Performance standards for IBS (resolution MSC.64(67), annex 1) and for INS (resolution MSC.86(70), annex 3). Refer to General requirements for Electromagnetic Compatibility for all Electrical and Electronic Ships Equipment (resolution A.813(19)).

Regulation 16 – Maintenance of equipment

1. The Administration shall be satisfied that adequate arrangements are in place to ensure that the performance of the equipment required by this chapter is maintained.
2. Except as provided in regulations I/7(b)(ii), I/8 and I/9, while all reasonable steps shall be taken to maintain the equipment required by this chapter in efficient working order, malfunctions of that equipment shall not be considered as making the ship unseaworthy or as a reason for delaying the ship in ports where repair facilities are not readily available, provided suitable arrangements are made by the master to take the inoperative equipment or unavailable information into account in planning and executing a safe voyage to a port where repairs can take place.

Regulation 17 – Electromagnetic compatibility

1. Administrations shall ensure that all electrical and electronic equipment on the bridge or in the vicinity of the bridge, on ships constructed on or after 1 July 2002, is tested for electromagnetic compatibility, taking into account the recommendations developed by the Organization.²⁰⁾
2. Electrical and electronic equipment shall be so installed that electromagnetic interference does not affect the proper function of navigational systems and equipment.
3. Portable electrical and electronic equipment shall not be operated on the bridge if it may affect the proper function of navigational systems and equipment.

Regulation 18 – Approval, surveys and performance standards of navigational systems and equipment and voyage data recorder

1. Systems and equipment required to meet the requirements of regulations 19 and 20 shall be of a type approved by the Administration.
2. Systems and equipment, including associated back-up arrangements, where applicable, installed on or after 1 July 2002 to perform the functional requirements of regulations 19 and 20 shall conform to appropriate performance standards not inferior to those adopted by the Organization.²¹⁾

²⁰⁾ Refer to the General requirements for electromagnetic compatibility for all electrical and electronic ship's equipment adopted by the Organization by resolution A.813

²¹⁾ Refer to the following recommendations adopted by the Organization by the resolutions indicated:

A.694(17) »Recommendations on general requirements for shipborne radio equipment forming part of the Global Maritime Distress and Safety System (GMDSS) and for Electronic Navigational Aids«; Resolution A.424(XI) »Performance standards for gyro-compasses«; Resolution MSC.192(79) »Revised recommendation on performance standards for radar equipment«; Resolution A.823(19) »Performance standards for automatic radar plotting aids«; Resolution A.817(19), as amended by resolutions MSC.64(67), annex 5 and MSC.86(70), annex 4 »Recommendation on performance standards for Electronic Chart Display and Information Systems (ECDIS)«; Resolution A.529(13) »Recommendation on accuracy standards for navigation«; Resolution A.818(19) »Recommendation on performance standards for shipborne Loran-C and Chayka receivers«; Resolution A.819(19) »Recommendation on performance standards for shipborne global positioning system receiver equipment«, as amended by resolution MSC.112(73); Resolution MSC.53(66), as amended by resolution MSC.113(73) »Recommendation on performance standards for shipborne GLONASS receiver equipment«; Resolution MSC.64(67), annex 2, as amended by resolution MSC.114(73) »Recommendation on performance standards for shipborne GPS and DGPS maritime radio beacon receiver equipment«; Resolution MSC.74(69), annex 1, as amended by resolution MSC.115(73) »Recommendation on performance standards for combined DGPS/DGLONASS receiver equipment«; Resolution MSC.233(82) »Performance standards for shipborne Galileo receiver equipment« Resolution MSC.64(67), annex 3, »Recommendation on performance standards for heading control systems«; Resolution MSC.74(69), annex 2, »Recommendation on Performance Standards for track control systems«; Resolution MSC.74(69), annex 3, »Recommendation on performance standards for universal shipborne automatic identification system (AIS)«; Resolution A.224(VII), as amended by Resolution MSC.74(69), annex 2, »Recommendation on performance standards for echo-

3. When systems and equipment are replaced or added on ships constructed before 1 July 2002, such systems and equipment shall, in so far as is reasonable and practicable, comply with the requirements of paragraph 2.
4. Systems and equipment installed prior to the adoption of performance standards by the Organization may subsequently be exempted from full compliance with such standards at the discretion of the Administration, having due regard to the recommended criteria adopted by the Organization. However, for an electronic chart display and information system (ECDIS) to be accepted as satisfying the chart carriage requirement of regulation 19.1.2.4, that system shall conform to the relevant performance standards not inferior to those adopted by the Organization in effect on the date of installation, or, for systems installed before 1 January 1999, not inferior to the performance standards adopted by the Organization on 23 November 1995.²²⁾
5. The Administration shall require that the manufacturers have a quality control system audited by a competent authority to ensure continuous compliance with the type approval conditions. Alternatively, the Administration may use final product verification procedures where the compliance with the type approval certificate is verified by a competent authority before the product is installed on board ships.
6. Before giving approval to systems or equipment embodying new features not covered by this chapter, the Administration shall ensure that such features support functions at least as effective as those required by this chapter.
7. When equipment, for which performance standards have been developed by the Organization, is carried on ships in addition to those items of equipment required by regulations 19 and 20, such equipment shall be subject to approval and shall, as far as practicable, comply with performance standards not inferior to those adopted by the Organization.
8. The voyage data recorder system, including all sensors, shall be subjected to an annual performance test. The test shall be conducted by an approved testing or servicing facility to verify the accuracy, duration and recoverability of the recorded data. In addition, tests and inspections shall be conducted to determine the serviceability of all protective enclosures and devices fitted to aid location. A copy of the certificate of compliance issued by the testing facility, stating the date of compliance and the applicable performance standards, shall be retained on board the ship.

sounding equipment«; Resolution A.824(19), as amended by resolution MSC.96(72), »Recommendation on performance standards for devices to indicate speed and distance«; Resolution A.526(13) »Performance standards for rate-of-turn indicators«; Resolution A.575(14) »Recommendation on unification of performance standards for navigational equipment«; Resolution A.343(IX) »Recommendation on methods of measuring noise levels at listening posts«; Resolution MSC.164(78) »Revised recommendation on performance standards for Radar Reflectors«; Resolution A.382(X) »Recommendation on performance standards for magnetic compasses«; Resolution MSC.95(72) »Recommendation on performance standards for daylight signalling lamps«; Resolution MSC.86(70), annex 1, »Recommendation on Performance Standards for sound reception systems«; Resolution MSC.86(70), annex 2 »Recommendation on Performance Standards for marine transmitting magnetic heading devices (TMHDS)« as well as Resolution MSC.116(73) »Performance Standards for sound reception systems«; Resolution A.861(20) »Recommendation on Performance Standards for voyage data recorders (VDRs)«; MSC.214(81) »Amendments to the performance standards for shipborne voyage data recorders (VDRS)« as well as MSC.163(78) »Performance standards for shipborne simplified voyage data recorders (S-VDRS)«; Resolution MSC.166(78) »Application of performance standards for marine transmitting heading devices (THDs) to marine transmitting magnetic heading devices (TMHDS)«; Resolution MSC.191(79) »Performance standards for the presentation of navigation-related information on ship-borne navigational displays«.

²²⁾ Recommendation on Performance Standards for Electronic Chart Display and Information Systems (ECDIS) (resolution A.817(19)).

Regulation 19 – Carriage requirements for shipborne navigational systems and equipment

1. Application and requirements

Subject to the provisions of regulation 1.4:

- 1.1. Ships constructed on or after 1 July 2002 shall be fitted with navigational systems and equipment which will fulfil the requirements prescribed in paragraphs 2.1 to 2.9. *as well as paragraph 7.*
- 1.2. Ships constructed before 1 July 2002 shall:
 - 1.2.1. subject to the provisions of paragraphs 1.2.2 and 1.2.3, unless they comply fully with this regulation, continue to be fitted with equipment which fulfils the requirements prescribed in regulations V/11, V/12 and V/20 of the International Convention for the Safety of Life at Sea, 1974 in force prior to 1 July 2002;
 - 1.2.2. be fitted with the equipment or systems required in paragraph 2.1.6 not later than the first survey after 1 July 2002, at which time the radio direction-finding apparatus referred to in V/12(p) of the International Convention for the Safety of Life at Sea, 1974 in force prior to 1 July 2002 shall no longer be required;
 - 1.2.3. be fitted with the system required in paragraph 2.4 not later than the dates specified in paragraphs 2.4.2 and 2.4.3; and
 - 1.2.4. *be fitted with a bridge navigation watch alarm in accordance with paragraph 7.*

2. Shipborne navigational equipment and systems

- 2.1. All ships, irrespective of size, shall have:
 - 2.1.1. a properly adjusted standard magnetic compass, or other means, independent of any power supply, to determine the ship's heading and display the reading at the main steering position;
 - 2.1.2. a pelorus or compass bearing device, or other means, independent of any power supply, to take bearings over an arc of the horizon of 360°;
 - 2.1.3. means of correcting heading and bearings to true at all times;
 - 2.1.4. nautical charts and nautical publications to plan and display the ship's route for the intended voyage and to plot and monitor positions throughout the voyage; an electronic chart display and information system (ECDIS) may be accepted as meeting the chart carriage requirements of this subparagraph;
 - 2.1.5. back-up arrangements to meet the functional requirements of subparagraph .4, if this function is partly or fully fulfilled by electronic means;²³⁾
 - 2.1.6. a receiver for a global navigation satellite system or a terrestrial radio-navigation system, or other means, suitable for use at all times throughout the intended voyage to establish and update the ship's position by automatic means;
 - 2.1.7. if less than 150 gross tonnage and if practicable, a radar reflector, or other means, to enable detection by ships navigating by radar at both 9 and 3 GHz;
 - 2.1.8. when the ship's bridge is totally enclosed and unless the Administration determines otherwise, a sound reception system, or other means, to enable the officer in charge of the navigational watch to hear sound signals and determine their direction;
 - 2.1.9. a telephone, or other means, to communicate heading information to the emergency steering position, if provided.

²³⁾ An appropriate folio of paper nautical charts may be used as a back-up arrangement for ECDIS. Other back-up arrangements for ECDIS are acceptable (see appendix 6 to resolution A.817(19), as amended).

- 2.2. All ships of 150 gross tonnage and upwards and passenger ships irrespective of size shall, in addition to the requirements of paragraph 2.1, be fitted with:
 - 2.2.1. a spare magnetic compass, interchangeable with the magnetic compass as referred to in paragraph 2.1.1, or other means to perform the function referred to in paragraph 2.1.1 by means of replacement or duplicate equipment;
 - 2.2.2. a daylight signalling lamp, or other means, to communicate by light during day and night using an energy source of electrical power not solely dependent upon the ship's power supply.
- 2.3. All ships of 300 gross tonnage and upwards and passenger ships irrespective of size shall, in addition to meeting the requirements of paragraph 2.2, be fitted with:
 - 2.3.1. an echo-sounding device, or other electronic means, to measure and display the available depth of water;
 - 2.3.2. a 9 GHz radar, or other means, to determine and display the range and bearing of radar transponders and of other surface craft, obstructions, buoys, shorelines and navigational marks to assist in navigation and in collision avoidance;
 - 2.3.3. an electronic plotting aid, or other means, to plot electronically the range and bearing of targets to determine collision risk;
 - 2.3.4. speed and distance measuring device, or other means, to indicate speed and distance through the water;
 - 2.3.5. a properly adjusted transmitting heading device, or other means, to transmit heading information for input to the equipment referred to in paragraphs 2.3.2, 2.3.3 and 2.4.
- 2.4. All ships of 300 gross tonnage and upwards engaged on international voyages and cargo ships of 500 gross tonnage and upwards not engaged on international voyages and passenger ships irrespective of size shall be fitted with an automatic identification system (AIS), as follows:
 - 2.4.1. ships constructed on or after 1 July 2002;
 - 2.4.2. ships engaged on international voyages constructed before 1 July 2002:
 - 2.4.2.1. in the case of passenger ships, not later than 1 July 2003;
 - 2.4.2.2. in the case of tankers, not later than the first survey for safety equipment²⁴⁾ on or after 1 July 2003;
 - 2.4.2.3. in the case of ships, other than passenger ships and tankers, of 50,000 gross tonnage and upwards, not later than 1 July 2004;
 - 2.4.2.4. in the case of ships, other than passenger ships and tankers, of 300 gross tonnage and upwards but less than 50,000 gross tonnage, not later than the first safety equipment survey²⁵⁾ after 1 July 2004 or by 31 December 2004, whichever occurs earlier; and
 - 2.4.3. ships not engaged on international voyages constructed before 1 July 2002, not later than 1 July 2008;
 - 2.4.4. the Administration may exempt ships from the application of the requirements of this paragraph when such ships will be taken permanently out of service within two years after the implementation date specified in subparagraphs .2 and .3;

²⁴⁾ Refer to regulation I/8.

²⁵⁾ The "First safety equipment survey" means the first annual survey, the first periodical survey or the first renewal survey for safety equipment, whichever is due first after 1 July 2004, and, in addition, in the case of ships under construction, the initial survey.

- 2.4.5. AIS shall:
 - 2.4.5.1. provide automatically to appropriately equipped shore stations, other ships and aircraft information, including the ship's identity, type, position, course, speed, navigational status and other safety-related information;
 - 2.4.5.2. receive automatically such information from similarly fitted ships;
 - 2.4.5.3. monitor and track ships; and
 - 2.4.5.4. exchange data with shore-based facilities;
- 2.4.6. the requirements of paragraph 2.4.5 shall not be applied to cases where international agreements, rules or standards provide for the protection of navigational information; and
- 2.4.7. AIS shall be operated taking into account the guidelines adopted by the Organization²⁶⁾. Ships fitted with AIS shall maintain AIS in operation at all times except where international agreements, rules or standards provide for the protection of navigational information.
- 2.5. All ships of 500 gross tonnage and upwards shall, in addition to meeting the requirements of paragraph 2.3, with the exception of paragraphs 2.3.3 and 2.3.5, and the requirements of paragraph 2.4, have:
 - 2.5.1. a gyrocompass, or other means, to determine and display their heading by shipborne non-magnetic means, being clearly readable by the helmsman at the main steering position. These means shall also transmit heading information for input to the equipment referred in paragraphs 2.3.2, 2.4 and 2.5.5
 - 2.5.2. a gyrocompass heading repeater, or other means, to supply heading information visually at the emergency steering position if provided;
 - 2.5.3. a gyrocompass bearing repeater, or other means, to take bearings, over an arc of the horizon of 360°, using the gyrocompass or other means referred to in subparagraph .1. However, ships of less than 1,600 gross tonnage shall be fitted with such means as far as possible;
 - 2.5.4. rudder, propeller, thrust, pitch and operational mode indicators, or other means, to determine and display rudder angle, propeller revolutions, the force and direction of thrust and, if applicable, the force and direction of lateral thrust and the pitch and operational mode, all to be readable from the conning position; and
 - 2.5.5. an automatic tracking aid, or other means, to plot automatically the range and bearing of other targets to determine collision risk.
- 2.6. On all ships of 500 gross tonnage and upwards, failure of one piece of equipment should not reduce the ship's ability to meet the requirements of paragraph 2.1.1, 2.1.2 and 2.1.4.
- 2.7. All ships of 3,000 gross tonnage and upwards shall, in addition to meeting the requirements of paragraph 2.5, have:
 - 2.7.1. a 3 GHz radar or, where considered appropriate by the Administration, a second 9 GHz radar, or other means, to determine and display the range and bearing of other surface craft, obstructions, buoys, shorelines and navigational marks to assist in navigation and in collision avoidance, which are functionally independent of those referred to in paragraph 2.3.2; and

²⁶⁾ Refer to the Guidelines for the onboard operational use of shipborne Automatic Identification Systems (AIS) adopted by the Organization by resolution A.917(22) as amended by resolution A.956(23).

- 2.7.2. a second automatic tracking aid, or other means, to plot automatically the range and bearing of other targets to determine collision risk which are functionally independent of those referred to in paragraph 2.5.5.
- 2.8. All ships of 10,000 gross tonnage and upwards shall, in addition to meeting the requirements of paragraph 2.7 with the exception of paragraph 2.7.2, have:
- 2.8.1. an automatic radar plotting aid, or other means, to plot automatically the range and bearing of at least 20 other targets, connected to a device to indicate speed and distance through the water, to determine collision risks and simulate a trial manoeuvre; and
- 2.8.2. a heading or track control system, or other means, to automatically control and keep to a heading and/or straight track.
- 2.9. All ships of 50,000 gross tonnage and upwards shall, in addition to meeting the requirements of paragraph 2.8, have:
- 2.9.1. a rate-of-turn indicator, or other means, to determine and display the rate of turn; and
- 2.9.2. a speed and distance measuring device, or other means, to indicate speed and distance over the ground in the forward and athwartships direction.
3. When "other means" are permitted under this regulation, such means must be approved by the Administration in accordance with regulation 18.
4. The navigational equipment and systems referred to in this regulation shall be so installed, tested and maintained as to minimize malfunction.
5. Navigational equipment and systems offering alternative modes of operation shall indicate the actual mode of use.
6. Integrated bridge systems²⁷⁾ shall be so arranged that failure of one sub-system is brought to the immediate attention of the officer in charge of the navigational watch by audible and visual alarms and does not cause failure to any other subsystem. In case of failure in one part of an integrated navigational system²⁸⁾, it shall be possible to operate each other individual item of equipment or part of the system separately.
7. *Ships fitted with a wheelhouse shall be equipped with a bridge navigation watch alarm which, as a minimum, meet the technical and operational requirements of IMO's performance standards. Such ships shall be equipped with a bridge navigation watch alarm in accordance with the following schedule:*
- 7.1. *ships constructed on or after 1 March 2003, upon delivery;*
- 7.2. *ships constructed before 1 March 2003:*
- 7.2.1. *ships with a gross tonnage below 500, not later than 1 March 2004;*
- 7.2.2. *ships with a gross tonnage below 3,000, but of or above 500, not later than 1 March 2005; and*
- 7.2.3. *all other ships, not later than 1 March 2006;*
- 7.3. *Ships which were equipped with a bridge navigation watch alarm before 1 March 2002 which ensures, in a satisfactory way, the awareness of the watch-keeping officer, but which does not*

²⁷⁾ Refer to resolution MSC.64(67), annex 1, Performance standard for integrated bridge systems.

²⁸⁾ Refer to resolution MSC.86(70), annex 3, Performance standard for integrated navigational systems.

fully comply with IMO's performance standards²⁹⁾, may use such an alarm instead of the prescribed bridge navigation watch alarm until 1 March 2006.
In ships equipped with an automatic heading control system or track control system, the bridge navigation watch alarm shall be switched on when this equipment is in use. In ships without and automatic heading control system or track control system, the bridge navigation watch alarm shall be switched on when the ship is located outside a port or safe anchorage.

Regulation 19-1 – Long-range identification and tracking of ships

- 1 Nothing in this regulation or the provisions of performance standards and functional requirements³⁰⁾ adopted by the Organization in relation to the long-range identification and tracking of ships shall prejudice the rights, jurisdiction or obligations of States under international law, in particular, the legal regimes of the high seas, the exclusive economic zone, the contiguous zone, the territorial seas or the straits used for international navigation and archipelagic sea lanes.
- 2
 - 2.1 Subject to the provisions of paragraphs 4.1 and 4.2, this regulation shall apply to the following types of ships engaged on international voyages:
 - 2.1.1 passenger ships, including high-speed passenger craft;
 - 2.1.2 cargo ships, including high-speed craft, of 300 gross tonnage³¹⁾ and upwards; and
 - 2.1.3 mobile offshore drilling units.
 - 2.2 The term “ship”, when used in paragraphs 3 to 11.2, includes the passenger and cargo ships, the high-speed craft and the mobile offshore drilling units which are subject to the provisions of this regulation.
- 3 This regulation establishes provisions to enable Contracting Governments to undertake the long-range identification and tracking of ships.
- 4
 - 4.1 Ships shall be fitted with a system to automatically transmit the information specified in paragraph 5 as follows:
 - 4.1.1 ships constructed on or after 31 December 2008;
 - 4.1.2 ships constructed before 31 December 2008 and certified for operations:
 - 4.1.2.1 in sea areas A1 and A2, as defined in regulations IV/2.1.12 and IV/2.1.13; or
 - 4.1.2.2 in sea areas A1, A2 and A3, as defined in regulations IV/2.1.12, IV/2.1.13 and IV/2.1.14; not later than the first survey of the radio installation after 31 December 2008;
 - 4.1.2.3 ships constructed before 31 December 2008 and certified for operations in sea areas A1, A2, A3 and A4, as defined in regulations IV/2.1.12, IV/2.1.13, IV/2.1.14 and IV/2.1.15, not later than the first survey of the radio installation after 1 July 2009. However, these ships shall comply with the provisions of subparagraph .2 above whilst they operate within sea areas A1, A2 and A3.

²⁹⁾ Resolution MSC.128(75), “Performance standards for Bridge Navigation Watch Alarms” (A Danish translation is available in Notices from the Danish Maritime Authority 5/2002).

³⁰⁾ Refer to the Performance standards and functional requirements for the long-range identification and tracking of ships, adopted by the Maritime Safety Committee of the Organization by resolution MSC.210(81).

³¹⁾ The gross tonnage to be used for determining whether a cargo ship or high-speed craft is required to comply with the provisions of this regulation shall be that determined under the provisions of the International Convention on Tonnage Measurement of Ships, 1969 irrespective of the date on which the ship or high-speed craft has been or is being constructed.

- 4.2 Ships, irrespective of the date of construction, fitted with an automatic identification system (AIS), as defined in regulation 19.2.4, and operated exclusively within sea area A1, as defined in regulation IV/2.1.12, shall not be required to comply with the provisions of this regulation.
- 5 Subject to the provisions of paragraph 4.1, ships shall automatically transmit the following long-range identification and tracking information:
- 5.1 the identity of the ship;
 - 5.2 the position of the ship (latitude and longitude); and
 - 5.3 the date and time of the position provided.
- 6 Systems and equipment used to meet the requirements of this regulation shall conform to performance standards and functional requirements not inferior to those adopted by the Organization. Any shipboard equipment shall be of a type approved by the Administration.
- 7 Systems and equipment used to meet the requirements of this regulation shall be capable of being switched off on board or be capable of ceasing the distribution of long-range identification and tracking information:
- 7.1 where international agreements, rules or standards provide for the protection of navigational information; or
 - 7.2 in exceptional circumstances and for the shortest duration possible where the operation is considered by the master to compromise the safety or security of the ship. In such a case, the master shall inform the Administration without undue delay and make an entry in the record of navigational activities and incidents maintained in accordance with regulation 28 setting out the reasons for the decision and indicating the period during which the system or equipment was switched off.
- 8
- 8.1 Subject to the provisions of paragraphs 8.2 to 11.2, Contracting Governments shall be able to receive long-range identification and tracking information about ships, for security and other purposes as agreed by the Organization, as follows:
- 8.1.1 the Administration shall be entitled to receive such information about ships entitled to fly its flag irrespective of where such ships may be located;
 - 8.1.2 a Contracting Government shall be entitled to receive such information about ships which have indicated their intention to enter a port facility, as defined in regulation XI-2/1.1.9, or a place under the jurisdiction of that Contracting Government, irrespective of where such ships may be located provided they are not located within the waters landward of the baselines, established in accordance with international law, of another Contracting Government; and
 - 8.1.3 a Contracting Government shall be entitled to receive such information about ships entitled to fly the flag of other Contracting Governments, not intending to enter a port facility or a place under the jurisdiction of that Contracting Government, navigating within a distance not exceeding 1,000 nautical miles of its coast provided such ships are not located within the waters landward of the baselines, established in accordance with international law, of another Contracting Government; and
 - 8.1.4 a Contracting Government shall not be entitled to receive, pursuant to subparagraph .3, such information about a ship located within the territorial sea of the Contracting Government whose flag the ship is entitled to fly.
- 8.2 Contracting Governments shall specify and communicate to the Organization relevant details, taking into account the performance standards and functional requirements adopted by the

Organization, to enable long-range identification and tracking information to be made available pursuant to the provisions of paragraph 8.1. The Contracting Government concerned may, at any time thereafter, amend or withdraw such communication. The Organization shall inform all Contracting Governments upon receipt of such communication together with the particulars thereof.

9

9.1 Notwithstanding the provisions of paragraph 8.1.3, the Administration shall be entitled, in order to meet security or other concerns, at any time, to decide that long-range identification and tracking information about ships entitled to fly its flag shall not be provided pursuant to the provisions of paragraph 8.1.3 to Contracting Governments. The Administration concerned may, at any time thereafter, amend, suspend or annul such decisions.

9.2 The Administration concerned shall communicate, pursuant to paragraph 9.1, such decisions to the Organization. The Organization shall inform all Contracting Governments upon receipt of such communication together with the particulars thereof.

9.3 The rights, duties and obligations, under international law, of the ships whose Administration invoked the provisions of paragraph 9.1 shall not be prejudiced as a result of such decisions.

10 Contracting Governments shall, at all times:

10.1 recognize the importance of long-range identification and tracking information;

10.2 recognize and respect the commercial confidentiality and sensitivity of any long-range identification and tracking information they may receive;

10.3 protect the information they may receive from unauthorized access or disclosure; and

10.4 use the information they may receive in a manner consistent with international law.

11

11.1 Contracting Governments shall bear all costs associated with any long-range identification and tracking information they request and receive. Notwithstanding the provisions of paragraph 11.2, Contracting Governments shall not impose any charges on ships in relation to the long-range identification and tracking information they may seek to receive.

11.2 Unless the national legislation of the Administration provides otherwise, ships entitled to fly its flag shall not incur any charges for transmitting long-range identification and tracking information in compliance with the provisions of this regulation.

12 Notwithstanding the provisions of paragraph 8.1, the search and rescue services of Contracting Governments shall be entitled to receive, free of any charges, long-range identification and tracking information in relation to the search and rescue of persons in distress at sea.

13 Contracting Governments may report to the Organization any case where they consider that provisions of this regulation or of any other related requirements established by the Organization have not been or are not being observed or adhered to.

14 The Maritime Safety Committee shall determine the criteria, procedures and arrangements for the establishment, review and audit of the provision of long-range identification and tracking information to Contracting Governments pursuant to the provisions of this regulation.

Regulation 20 – Voyage data recorders

1 To assist in casualty investigations, ships, when engaged on international voyages, subject to the provisions of regulation 1.4, shall be fitted with a voyage data recorder (VDR) as follows:

1.1 passenger ships constructed on or after 1 July 2002;

- 1.2 ro-ro passenger ships constructed before 1 July 2002, not later than the first survey on or after 1 July 2002;
 - 1.3 passenger ships, other than ro-ro passenger ships, constructed before 1 July 2002, not later than 1 January 2004; and
 - 1.4 ships, other than passenger ships, of 3,000 gross tonnage and upwards constructed on or after 1 July 2002.
- 2 To assist in casualty investigations, cargo ships, when engaged on international voyages, shall be fitted with a VDR which may be a simplified voyage data recorder (S-VDR) as follows:
 - 2.1 in the case of cargo ships of 20,000 gross tonnage and upwards constructed before 1 July 2002, at the first scheduled dry-docking after 1 July 2006 but not later than 1 July 2009;
 - 2.2 in the case of cargo ships of 3,000 gross tonnage and upwards but less than 20,000 gross tonnage constructed before 1 July 2002, at the first scheduled dry-docking after 1 July 2007 but not later than 1 July 2010; and
 - 2.3 Administrations may exempt cargo ships from the application of the requirements of subparagraphs .1 and .2 when such ships will be taken permanently out of service within two years after the implementation date specified in subparagraphs .1 and .2 above.
 - 3 Administrations may exempt ships, other than ro-ro passenger ships, constructed before 1 July 2002 from being fitted with a VDR where it can be demonstrated that interfacing a VDR with the existing equipment on the ship is unreasonable and impracticable.

Regulation 21 – International Code of Signals and IAMSAR Manual

1. All ships which, in accordance with this set of regulations, are required to carry a radio installation shall carry the International Code of Signals as may be amended by the Organization. The Code shall also be carried by any other ship which, in the opinion of the Administration, has a need to use it.
2. All ships shall carry an up-to-date copy of Volume III of the International Aeronautical and Maritime Search and Rescue (IAMSAR) Manual.³²⁾
3. *Ships engaged on voyages outside restricted trade (voyages in the North Sea east of 3 E longitude and south of 61 N latitude as well as in the Baltic Sea and intermediate waters) as well as ships engaged on voyages more than 200 nautical miles from the coast of Greenland shall be equipped with a copy of IMO's maritime communication phrases.*³³⁾

Regulation 22 – Navigation bridge visibility

1. Ships of not less than 55 m in length, as defined in regulation 2.4, constructed on or after 1 July 1998, shall meet the following requirements:
 - 1.1. The view of the sea surface from the conning position shall not be obscured by more than two ship lengths, or 500 m, whichever is less, forward of the bow³⁴⁾ to 10° on either side under all conditions of draught, trim and deck cargo;
 - 1.2. No blind sector, caused by cargo, cargo gear or other obstructions outside of the wheelhouse forward of the beam which obstructs the view of the sea surface as seen from the conning position, shall exceed 10°. The total arc of blind sectors shall not exceed 20°. The clear

³²⁾ Joint ICAO and IMO manual on aeronautical and maritime rescue services.

³³⁾ Reference is made to resolution A.918(22), "Standard Marine Communication Phrases (SMCPs)".

³⁴⁾ Reference is made to ISO 8468: 1900 (E), 4.1.2.

sectors between blind sectors shall be at least 5°. However, in the view described in .1, each individual blind sector shall not exceed 5°;

- 1.3. The horizontal field of vision from the conning position shall extend over an arc of not less than 225°, that is from right ahead to not less than 22.5° abaft the beam on either side of the ship;
- 1.4. From each bridge wing, the horizontal field of vision shall extend over an arc of at least 225°, that is from at least 45° on the opposite bow through right ahead and then from right ahead to right astern through 180° on the same side of the ship;
- 1.5. From the main steering position, the horizontal field of vision shall extend over an arc from right ahead to at least 60° on each side of the ship;
- 1.6. The ship's side shall be visible from the bridge wing;
- 1.7. The height of the lower edge of the navigation bridge front windows above the bridge deck shall be kept as low as possible. In no case shall the lower edge present an obstruction to the forward view as described in this regulation;
- 1.8. The upper edge of the navigation bridge front windows shall allow a forward view of the horizon, for a person with a height of eye of 1,800 mm above the bridge deck at the conning position, when the ship is pitching in heavy seas. The Administration, if satisfied that a 1,800 mm height of eye is unreasonable and impractical, may allow reduction of the height of eye but not to less than 1,600 mm;
- 1.9. Windows shall meet the following requirements:
 - 1.9.1. To help avoid reflections, the bridge front windows shall be inclined from the vertical plane top out, at an angle of not less than 10° and not more than 25°;
 - 1.9.2. Framing between navigation bridge windows shall be kept to a minimum and not be installed immediately forward of any work station;
 - 1.9.3. Polarized and tinted windows shall not be fitted;
 - 1.9.4. A clear view through at least two of the navigation bridge front windows and, depending on the bridge configuration, an additional number of clear-view windows shall be provided at all times, regardless of weather conditions.
2. Ships constructed before 1 July 1998 shall, where practicable, meet the requirements of paragraphs 1.1 and 1.2. However, structural alterations or additional equipment need not be required.
 - 2a *Ships with a length of 15 metres or more, but below 55 metres, shall comply with the provisions of paragraph 1. Such ships constructed before 1 July 2006 shall comply with the provisions of paragraph 1 in as far as possible, however, the wheelhouse visibility shall, as a minimum, comply with the recommendations of the Organisation.*³⁵⁾
3. On ships of unconventional design which, in the opinion of the Administration, cannot comply with this regulation, arrangements shall be provided to achieve a level of visibility that is as near as practical to that prescribed in this regulation.
4. Notwithstanding the requirements of paragraphs 1.1, 1.3, 1.4 and 1.5, ballast water exchange may be undertaken provided that:
 - 4.1. the master has determined that it is safe to do so and takes into consideration any increased blind sectors or reduced horizontal fields of vision resulting from the operation to ensure that a proper lookout is maintained at all times;

³⁵⁾ Reference is made to resolution A.708(17), "Navigation bridge visibility and functions".

- 4.2. the operation is conducted in accordance with the ship's ballast water management plan, taking into account the recommendation on ballast water exchange adopted by the Organization; and
- 4.3. the commencement and termination of the operation are recorded in the ship's record of navigational activities pursuant to regulation 28.

Regulation 23 – Pilot transfer arrangements

1. Application

- 1.1. Ships engaged on voyages in the course of which pilots are likely to be employed shall be provided with pilot transfer arrangements.
- 1.2. Equipment and arrangements for pilot transfer which are installed on or after 1 January 1994 shall comply with the requirements of this regulation, and due regard shall be paid to the standards adopted by the Organization.³⁶⁾
- 1.3. Equipment and arrangements for pilot transfer which are provided on ships before 1 January 1994 shall at least comply with the requirements of regulation 17 of the International Convention for the Safety of Life at Sea, 1974 in force prior to that date, and due regard shall be paid to the standards adopted by the Organization prior to that date.
- 1.4. Equipment and arrangements which are replaced after 1 January 1994 shall, in so far as is reasonable and practicable, comply with the requirements of this regulation.

2. General

- 2.1. All arrangements used for pilot transfer shall efficiently fulfil their purpose of enabling pilots to embark and disembark safely. The appliances shall be kept clean, properly maintained and stowed and shall be regularly inspected to ensure that they are safe to use. They shall be used solely for the embarkation and disembarkation of personnel.
- 2.2. The rigging of the pilot transfer arrangements and the embarkation of a pilot shall be supervised by a responsible officer having means of communication with the navigation bridge who shall also arrange for the escort of the pilot by a safe route to and from the navigation bridge. Personnel engaged in rigging and operating any mechanical equipment shall be instructed in the safe procedures to be adopted and the equipment shall be tested prior to use.

3. Transfer arrangements

- 3.1. Arrangements shall be provided to enable the pilot to embark and disembark safely on either side of the ship.
- 3.2. In all ships where the distance from sea level to the point of access to, or egress from, the ship exceeds 9 m, and when it is intended to embark and disembark pilots by means of the accommodation ladder, or by means of mechanical pilot hoists or other equally safe and convenient means in conjunction with a pilot ladder, the ship shall carry such equipment on each side, unless the equipment is capable of being transferred for use on either side.
- 3.3. Safe and convenient access to, and egress from, the ship shall be provided by either:
 - 3.3.1. a pilot ladder requiring a climb of not less than 1.5 m and not more than 9 m above the surface of the water, so positioned and secured that:
 - 3.3.1.1. it is clear of any possible discharges from the ship;

³⁶⁾ Refer to the Recommendation on pilot transfer arrangements adopted by the Organization by resolution A.889(21) and to MSC/Circ.568/Rev.1, Required boarding arrangements for pilots.

- 3.3.1.2. it is within the parallel body length of the ship and, as far as is practicable, within the mid-ship half length of the ship;
- 3.3.1.3. each step rests firmly against the ship's side; where constructional features, such as rubbing bands, would prevent the implementation of this provision, special arrangements shall, to the satisfaction of the Administration, be made to ensure that persons are able to embark and disembark safely;
- 3.3.1.4. the single length of pilot ladder is capable of reaching the water from the point of access to, or egress from, the ship and due allowance is made for all conditions of loading and trim of the ship, and for an adverse list of 15°; the securing strong point, shackles and securing ropes shall be at least as strong as the side ropes;
- 3.3.2. an accommodation ladder in conjunction with the pilot ladder, or other equally safe and convenient means, whenever the distance from the surface of the water to the point of access to the ship is more than 9 m. The accommodation ladder shall be sited leading aft. When in use, the lower end of the accommodation ladder shall rest firmly against the ship's side within the parallel body length of the ship and, as far as is practicable, within the mid-ship half length and clear of all discharges; or
- 3.3.3. a mechanical pilot hoist so located that it is within the parallel body length of the ship and, as far as is practicable, within the mid-ship half length of the ship and clear of all discharges.

4. Access to the ship's deck

- 4.1. Means shall be provided to ensure safe, convenient and unobstructed passage for any person embarking on, or disembarking from, the ship between the head of the pilot ladder, or of any accommodation ladder or other appliance, and the ship's deck. Where such passage is by means of:
 - 4.1.1. a gateway in the rails or bulwark, adequate handholds shall be provided;
 - 4.1.2. bulwark ladder, two handhold stanchions rigidly secured to the ship's structure at or near their bases and at higher points shall be fitted. The bulwark ladder shall be securely attached to the ship to prevent overturning.

5. Shiplside doors

Shiplside doors used for pilot transfer shall not open outwards.

6. Mechanical pilot hoists

- 6.1. The mechanical pilot hoist and its ancillary equipment shall be of a type approved by the Administration. The pilot hoist shall be designed to operate as a moving ladder to lift and lower one person on the side of the ship, or as a platform to lift and lower one or more persons on the side of the ship. It shall be of such design and construction as to ensure that the pilot can be embarked and disembarked in a safe manner, including a safe access from the hoist to the deck and vice versa. Such access shall be gained directly by a platform securely guarded by handrails.
- 6.2. Efficient hand gear shall be provided to lower or recover the person or persons carried, and kept ready for use in the event of power failure.
- 6.3. The hoist shall be securely attached to the structure of the ship. Attachment shall not be solely by means of the ship's side rails. Proper and strong attachment points shall be provided for hoists of the portable type on each side of the ship.

- 6.4. If belting is fitted in the way of the hoist position, such belting shall be cut back sufficiently to allow the hoist to operate against the ship's side.
- 6.5. A pilot ladder shall be rigged adjacent to the hoist and be available for immediate use so that access to it is available from the hoist at any point of its travel. The pilot ladder shall be capable of reaching the sea level from its own point of access to the ship.
- 6.6. The position on the ship's side where the hoist will be lowered shall be indicated.
- 6.7. An adequate protected stowage position shall be provided for the portable hoist. In very cold weather, to avoid the danger of ice formation, the portable hoist shall not be rigged until its use is imminent.

7. Associated equipment

- 7.1. The following associated equipment shall be kept at hand ready for immediate use when persons are being transferred:
 - 7.1.1. two "man-ropes" of not less than 28 mm in diameter, properly secured to the ship, if required by the pilot;
 - 7.1.2. a lifebuoy equipped with a self-igniting light;
 - 7.1.3. a heaving line.
- 7.2. When required by paragraph 4, stanchions and bulwark ladders shall be provided.

8. Lighting

- 8.1. Adequate lighting shall be provided to illuminate the transfer arrangements overside, the position on deck where a person embarks or disembarks and the controls of the mechanical pilot hoist.

Regulation 24 – Use of heading and/or track control systems

1. In areas of high traffic density, in conditions of restricted visibility and in all other hazardous navigational situations where heading and/or track control systems are in use, it shall be possible to establish manual control of the ship's steering immediately.
2. In circumstances as above, the officer in charge of the navigational watch shall have available without delay the services of a qualified helmsperson who shall be ready at all times to take over steering control.
3. The change-over from automatic to manual steering and vice versa shall be made by, or under the supervision of, a responsible officer.
4. The manual steering shall be tested after prolonged use of heading and/or track control systems and before entering areas where navigation demands special caution.

Regulation 25 – Operation of steering gear

In areas where navigation demands special caution, ships shall have more than one steering gear power unit in operation when such units are capable of simultaneous operation.

Regulation 26 – Steering gear: testing and drills

1. Within 12 hours before departure, the ship's steering gear shall be checked and tested by the ship's crew. The test procedure shall include, where applicable, the operation of the following:
 - 1.1. the main steering gear;
 - 1.2. the auxiliary steering gear;
 - 1.3. the remote steering gear control systems;

- 1.4. the steering positions located on the navigation bridge;
- 1.5. the emergency power supply;
- 1.6. the rudder angle indicators in relation to the actual position of the rudder;
- 1.7. the remote steering gear control system power failure alarms;
- 1.8. the steering gear power unit failure alarms; and
- 1.9. automatic isolating arrangements and other automatic equipment.
2. The checks and tests shall include:
 - 2.1. the full movement of the rudder according to the required capabilities of the steering gear;
 - 2.2. a visual inspection of the steering gear and its connecting linkage; and
 - 2.3. the operation of the means of communication between the navigation bridge and steering gear compartment.
3.
 - 3.1. Simple operating instructions with a block diagram showing the change-over procedures for remote steering gear control systems and steering gear power units shall be permanently displayed on the navigation bridge and in the steering compartment.
 - 3.2. All ships' officers concerned with the operation and/or maintenance of steering gear shall be familiar with the operation of the steering systems fitted on the ship and with the procedures for changing from one system to another.
4. In addition to the routine checks and tests prescribed in paragraphs 1 and 2, emergency steering drills shall take place at least once every three months in order to practise emergency steering procedures. These drills shall include direct control within the steering gear compartment, the communications procedure with the navigation bridge and, where applicable, the operation of alternative power supplies.
5. The Administration may waive the requirements to carry out the checks and tests prescribed in paragraphs 1 and 2 for ships which regularly engage on voyages of short duration. *Ships engaged on regular voyages of less than 12 hours' duration and with stays in ports of less than 12 hours between such voyages shall be exempted from carrying out the checks and tests required in paragraphs 1 and 2 above.* Such ships shall carry out these checks and tests at least once every week.
6. The date upon which the checks and tests prescribed in paragraphs 1 and 2 are carried out and the date and details of emergency steering drills carried out under paragraph 4 shall be recorded.

Regulation 27 – Nautical charts and nautical publications

Nautical charts and nautical publications, such as sailing directions, lists of lights, notices to mariners, tide tables and all other nautical publications necessary for the intended voyage, shall be adequate and up to date.

Regulation 28 – Records of navigational activities and daily reporting

- 1 All ships engaged on international voyages shall keep on board a record of navigational activities and incidents which are of importance to safety of navigation and which must contain sufficient detail to restore a complete record of the voyage, taking into account the recommendations adopted by the Organization.³⁷⁾ When such information is not maintained in the ship's log-book, it shall be maintained in another form approved by the Administration.

³⁷⁾ Refer to the Guidelines for recording events related to navigation adopted by the Organization by resolution A.916 (22).

- 2 Each ship of 500 gross tonnage and above, engaged on international voyages exceeding 48 hours, shall submit a daily report to its company, as defined in regulation IX/1, which shall retain it and all subsequent daily reports for the duration of the voyage. Daily reports may be transmitted by any means, provided that they are transmitted to the company as soon as practicable after determination of the position named in the report. Automated reporting systems may be used, provided that they include a recording function of their transmission and that those functions and interfaces with position-fixing equipment are subjected to regular verification by the ship's master. The report shall contain the following:
 - 2.1 ship's position;
 - 2.2 ship's course and speed; and
 - 2.3 details of any external or internal conditions that are affecting the ship's voyage or the normal safe operation of the ship.

Regulation 29 – Life-saving signals to be used by ships, aircraft or persons in distress

An illustrated table describing the life-saving signals³⁸⁾ shall be readily available to the officer of the watch of every ship to which this chapter applies. The signals shall be used by ships or persons in distress when communicating with life-saving stations, maritime rescue units and aircraft engaged in search and rescue operations.

Regulation 30 – Operational limitations

1. This regulation applies to all passenger ships to which chapter I applies.
2. A list of all limitations on the operation of a passenger ship, including exemptions from any of these regulations, restrictions in operating areas, weather restrictions, sea state restrictions, restrictions in permissible loads, trim, speed and any other limitations, whether imposed by the Administration or established during the design or the building stages, shall be compiled before the passenger ship is put in service. The list, together with any necessary explanations, shall be documented in a form acceptable to the Administration, which shall be kept on board readily available to the master. The list shall be kept updated. If the language used is not English or French, the list shall be provided in one of the two languages.

Regulation 31 – Danger messages

1. The master of every ship which meets with dangerous ice, a dangerous derelict, or any other direct danger to navigation, or a tropical storm, or encounters subfreezing air temperatures associated with gale force winds causing severe ice accretion on superstructures, or winds of force 10 (24-28 *m/sec.*) or above on the Beaufort scale for which no storm warning has been received, is bound to communicate the information by all means at his disposal to ships in the vicinity, and also to the competent authorities. The form in which the information is sent is not obligatory. It may be transmitted either in plain language (preferably English) or by means of the International Code of Signals.

³⁸⁾ Such life-saving signals are described in the International Aeronautical and Maritime Search and Rescue (IAMSAR) Manual, volume III, Mobile Facilities, and illustrated in the International Code of Signals, as amended pursuant to resolution A.80(IV).

2. Each Contracting Government will take all steps necessary to ensure that when intelligence of any of the dangers specified in paragraph 1 is received, it will be promptly brought to the knowledge of those concerned and communicated to other interested Governments.
3. The transmission of messages regarding the dangers specified is free of cost to the ships concerned.
4. All radio messages issued under paragraph 1 shall be preceded by the safety signal, using the procedure as prescribed by the Radio Regulations as defined in regulation IV/2.

Regulation 32 – Information required in danger messages

The following information is required in danger messages:

1. Ice, derelicts and other direct dangers to navigation:
 - 1.1. The kind of ice, derelict or danger observed.
 - 1.2. The position of the ice, derelict or danger when last observed.
 - 1.3. The time and date (Universal Coordinated Time) when the danger was last observed.
2. Tropical cyclones (storms).³⁹⁾
 - 2.1. A statement that a tropical cyclone has been encountered. This obligation should be interpreted in a broad spirit, and information transmitted whenever the master has good reason to believe that a tropical cyclone is developing or exists in the neighbourhood.
 - 2.2. Time, date (Universal Co-ordinated Time) and position of ship when the observation was taken.
 - 2.3. As much of the following information as is practicable should be included in the message:
 - barometric pressure⁴⁰⁾, preferably corrected (stating millibars, millimetres, or inches, and whether corrected or uncorrected);
 - barometric tendency (the change in barometric pressure during the past three hours);
 - true wind direction;
 - wind force (Beaufort scale);
 - state of the sea (smooth, moderate, rough, high);
 - swell (slight, moderate, heavy) and the true direction from which it comes. Period or length of swell (short, average, long) would also be of value;
 - true course and speed of ship.

Subsequent observations

3. When a master has reported a tropical cyclone or other dangerous storm, it is desirable, but not obligatory, that further observations be made and transmitted hourly, if practicable, but in any case at intervals of not more than 3 hours, so long as the ship remains under the influence of the storm.
4. Winds of force 10 (25 m/sec.) or above on the Beaufort scale for which no storm warning has been received. This is intended to deal with storms other than the tropical cyclones referred to in paragraph 2; when such a storm is encountered, the message should contain similar information to that listed under the paragraph but excluding the details concerning sea and swell.
5. Sub-freezing air temperatures associated with gale force winds causing severe ice accretion on superstructures:

³⁹⁾ The term “tropical cyclone” is the generic term used by national meteorological services of the World Meteorological Organization. The terms hurricane, “typhoon, cyclone, severe tropical storm”, etc, may also be used, depending on the geographic location.

⁴⁰⁾ The standard international unit for barometric pressure is the hectopascal (hPa), which is numerically equivalent to the millibar (mbar).

- 5.1. Time and date (Universal Co-ordinated Time).
- 5.2. Air temperature.
- 5.3. Sea temperature (if practicable).
- 5.4. Wind force and direction.

“Examples”

“Ice”

TTT ICE. LARGE BERG SIGHTED IN 4506 N, 4410W, AT 0800 UTC. MAY 15.

“Derelicts”

TTT DERELICT. OBSERVED DERELICT ALMOST SUBMERGED IN 4006 N, 1243 W, AT 1630 UTC. APRIL 21.

“Danger to navigation”

TTT NAVIGATION. ALPHA LIGHTSHIP NOT ON STATION. 1800 UTC. JANUARY 3.

“Tropical cyclone”

TTT STORM. 0030 UTC. AUGUST 18. 2004 N, 11354 E. BAROMETER CORRECTED 994 MILLIBARS, TENDENCY DOWN 6 MILLIBARS. WIND NW, FORCE 9, HEAVY SQUALLS. HEAVY EASTERLY SWELL. COURSE 067, 5 KNOTS.

TTT STORM. APPEARANCES INDICATE APPROACH OF HURRICANE. 1300 UTC. SEPTEMBER 14. 2200 N, 7236 W. BAROMETER CORRECTED 29.64 INCHES, TENDENCY DOWN .015 INCHES. WIND NE, FORCE 8, FREQUENT RAIN SQUALLS. COURSE 035, 9 KNOTS.

TTT STORM. CONDITIONS INDICATE INTENSE CYCLONE HAS FORMED. 0200 UTC. MAY 4. 1620 N, 9203 E. BAROMETER UNCORRECTED 753 MILLIMETRES, TENDENCY DOWN 5 MILLIMETRES. WIND S BY W, FORCE 5. COURSE 300, 8 KNOTS.

TTT STORM. TYPHOON TO SOUTHEAST. 0300 UTC. JUNE 12. 1812 N, 12605 E. BAROMETER FALLING RAPIDLY. WIND INCREASING FROM N.

TTT STORM. WIND FORCE 11, NO STORM WARNING RECEIVED. 0300 UTC. MAY 4. 4830 N, 30 W. BAROMETER CORRECTED 983 MILLIBARS, TENDENCY DOWN 4 MILLIBARS. WIND SW, FORCE 11 VEERING. COURSE 260, 6 KNOTS.

“Icing”

TTT EXPERIENCING SEVERE ICING. 1400 UTC. MARCH 2. 69 N, 10 W. AIR TEMPERATURE 18° F (-7.8°C). SEA TEMPERATURE 29°F (-1.7° C). WIND NE, FORCE 8.

Regulation 33 – Distress messages: obligations and procedures

1. The master of a ship at sea which is in a position to be able to provide assistance, on receiving information from any source that persons are in distress at sea, is bound to proceed with all speed to their assistance, if possible informing them or the search and rescue service that the ship is doing so. This obligation to provide assistance applies regardless of the nationality or status of such persons or the circumstances in which they are found. If the ship receiving the distress alert is unable or, in the special circumstances of the case, considers it unreasonable or unnecessary to proceed to their assistance, the master must enter in the log-book the reason for failing to proceed to the assistance of the persons in distress, taking into account the recommendation of the Organization to inform the appropriate search and rescue service accordingly.
- 1-1 Contracting Governments shall co-ordinate and co-operate to ensure that masters of ships providing assistance by embarking persons in distress at sea are released from their obligations with minimum further deviation from the ship's intended voyage, provided that releasing the master of the ship from the obligations under the current regulation does not further endanger the safety of life at sea. The Contracting Government responsible for the search and rescue region in which such assistance is rendered shall exercise primary responsibility for ensuring such co-ordination and co-operation occurs, so that survivors assisted are disembarked from the assisting ship and delivered to a place of safety, taking into account the particular circumstances of the case and guidelines developed by the Organization. In these cases the relevant Contracting Governments shall arrange for such disembarkation to be effected as soon as reasonably practicable.
2. The master of a ship in distress or the search and rescue service concerned, after consultation, so far as may be possible, with the masters of ships which answer the distress alert, has the right to requisition one or more of those ships as the master of the ship in distress or the search and rescue service considers best able to render assistance, and it shall be the duty of the master or masters of the ship or ships requisitioned to comply with the requisition by continuing to proceed with all speed to the assistance of persons in distress.
3. Masters of ships shall be released from the obligation imposed by paragraph 1 on learning that their ships have not been requisitioned and that one or more other ships have been requisitioned and are complying with the requisition. This decision shall, if possible, be communicated to the other requisitioned ships and to the search and rescue service.
4. The master of a ship shall be released from the obligation imposed by paragraph 1 and, if his ship has been requisitioned, from the obligation imposed by paragraph 2 on being informed by the persons in distress or by the search and rescue service or by the master of another ship which has reached such persons that assistance is no longer necessary.
5. The provisions of this regulation do not prejudice the Convention for the Unification of Certain Rules of Law relating to Assistance and Salvage at Sea, signed at Brussels on 23 September 1910, particularly the obligation to render assistance imposed by article 11 of that Convention.⁴¹⁾
6. Masters of ships who have embarked persons in distress at sea shall treat them with humanity, within the capabilities and limitations of the ship.

⁴¹⁾ International Convention on Salvage, 1989, done at London on 28 April 1989, entered into force on 14 July 1996.

Regulation 34 – Safe navigation and avoidance of dangerous situations

1. Prior to proceeding to sea, the master shall ensure that the intended voyage has been planned using the appropriate nautical charts and nautical publications for the area concerned, taking into account the guidelines and recommendations developed by the Organization.⁴²⁾
2. The voyage plan shall identify a route which:
 - 2.1. takes into account any relevant ships' routing systems;
 - 2.2. ensures sufficient sea room for the safe passage of the ship throughout the voyage;
 - 2.3. anticipates all known navigational hazards and adverse weather conditions; and
 - 2.4. takes into account the marine environmental protection measures that apply, and avoids, as far as possible, actions and activities which could cause damage to the environment.

Regulation 34-1 Master's discretion

The owner, the charterer, the company operating the ship as defined in regulation IX/1, or any other person shall not prevent or restrict the master of the ship from taking or executing any decision which, in the master's professional judgement, is necessary for safety of life at sea and protection of the marine environment.

Regulation 35 – Misuse of distress signals

The use of an international distress signal, except for the purpose of indicating that a person or persons are in distress, and the use of any signal which may be confused with an international distress signal are prohibited.

Regulation 36 – Navigation lights, shapes and sound signals

1. *All ships shall be provided with navigation lights, shapes and sound signal devices to such an extent that they comply with the Convention on the International Regulations for Preventing Collisions at Sea, 1972, as amended. The design of the shapes and the effectiveness and installation of the sound signal devices on board shall be in accordance with the International Regulations for Preventing Collisions at Sea as well as the regulations issued by the Danish Maritime Authority in force at any time.*
2. *All ships constructed on or after 1 July 2002 shall be provided with a spare set of permanently installed electrical navigation lights for the top, side, stern and anchor lights prescribed in the International Regulations for Preventing Collisions at Sea for the type of ship in question. Ships constructed before 1 July 2002 and engaged on voyages outside restricted trade shall be provided with a spare set of navigation lights for the top, side, stern and anchor lights prescribed in the International Regulations for Preventing Collisions at Sea for the type of ship in question. If the spare navigation lights are designed for electrical lighting, it shall be possible to connect them to the ship's emergency power source.*
3. *Navigation lights and sound signal devices shall be of an approved type and comply with the provisions of the Convention on the International Regulations for Preventing Collisions at Sea, 1972, as amended.*

⁴²⁾ Refer to the Guidelines for voyage planning adopted by the Organization by resolution A.893(21).

Appendix to chapter V

Rules for the management, operation and financing of the North Atlantic Ice Patrol

1. In these Rules:

- 1.1. "Ice season" means the annual period between 15 February and 1 July.
- 1.2. "Region of icebergs guarded by the Ice Patrol" means the south-eastern, southern and south-western limits of the region of icebergs in the vicinity of the Grand Banks of Newfoundland.
- 1.3. "Routes passing through regions of icebergs guarded by the Ice Patrol" means:
 - 1.3.1. routes between Atlantic coast ports of Canada (including inland ports approached from the North Atlantic through the Gut of Canso and Cabot Straits) and ports of Europe, Asia or Africa approached from the North Atlantic through or north of the Straits of Gibraltar (except routes which pass south of the extreme limits of ice of all types);
 - 1.3.2. routes via Cape Race, Newfoundland, between Atlantic coast ports of Canada (including inland ports approached from the North Atlantic through the Gut of Canso and Cabot Straits) west of Cape Race, Newfoundland, and Atlantic coast ports of Canada north of Cape Race, Newfoundland;
 - 1.3.3. routes between Atlantic and Gulf Coast ports of the United States of America (including inland ports approached from the North Atlantic through the Gut of Canso and Cabot Straits) and ports of Europe, Asia or Africa approached from the North Atlantic through or north of the Straits of Gibraltar (except routes which pass south of the extreme limits of ice of all types);
 - 1.3.4. routes via Cape Race, Newfoundland, between Atlantic and Gulf Coast ports of the United States of America (including inland ports approached from the North Atlantic through the Gut of Canso and Cabot Straits) and Atlantic Coast ports of Canada north of Cape Race, Newfoundland.
- 1.4. "Extreme limits of ice of all types" in the North Atlantic Ocean is defined by a line connecting the following points:

A – 42° 23'.00 N, 59° 25'.00 W
B – 41° 23'.00 N, 57° 00'.00 W
C – 40° 47'.00 N, 55° 00'.00 W
D – 40° 07'.00 N, 53° 00'.00 W
E – 39° 18'.00 N, 49° 39'.00 W
F – 38° 00'.00 N, 47° 35'.00 W
G – 37° 41'.00 N, 46° 40'.00 W
H – 38° 00'.00 N, 45° 33'.00 W
I – 39° 05'.00 N, 43° 00'.00 W
J – 39° 49'.00 N, 41° 00'.00 W
K – 40° 39'.00 N, 39° 00'.00 W
L – 41° 19'.00 N, 38° 00'.00 W
M – 43° 00'.00 N, 37° 27'.00 W
N – 44° 00'.00 N, 37° 29'.00 W

O – 46° 00'.00 N, 37° 55'.00 W
P – 48° 00'.00 N, 38° 28'.00 W
Q – 50° 00'.00 N, 39° 07'.00 W
R – 51° 25'.00 N, 39° 45'.00 W.

- 1.5. “Managing and operating” means maintaining, administering and operating the Ice Patrol, including the dissemination of information received therefrom.
- 1.6. “Contributing Government” means a Contracting Government undertaking to contribute to the costs of the Ice Patrol Service pursuant to these Rules.
2. Each Contracting Government specially interested in these services whose ships pass through the region of icebergs during the ice season undertakes to contribute to the Government of the United States of America its proportionate share of the costs for the management and operation of the Ice Patrol Service. The contribution to the Government of the United States of America shall be based on the ratio which the average annual gross tonnage of that contributing Government's ships passing through the region of icebergs guarded by the Ice Patrol during the previous three ice seasons bears to the combined average annual gross tonnage of all ships that passed through the region of icebergs guarded by the Ice Patrol during the previous three ice seasons.
3. All contributions shall be calculated by multiplying the ratio described in paragraph 2 by the average actual annual cost incurred by the Governments of the United States of America and Canada of managing and operating ice patrol services during the previous three years. This ratio shall be computed annually, and shall be expressed in terms of a lump sum per-annum fee.
4. Each of the contributing Governments has the right to alter or discontinue its contribution, and other interested Governments may undertake to contribute to the expense. The contributing Government which avails itself of this right will continue to be responsible for its current contribution up to 1 September following the date of giving notice of intention to alter or discontinue its contribution. To take advantage of the said right it must give notice to the managing Government at least six months before the said 1 September.
5. Each contributing Government shall notify the Secretary-General of its undertaking pursuant to paragraph 2, who shall notify all Contracting Governments.
6. The Government of the United States of America shall furnish annually to each contributing Government a statement of the total cost incurred by the Governments of the United States of America and Canada of managing and operating the Ice Patrol for that year and of the average percentage share for the past three years of each contributing Government.
7. The managing Government shall publish annual accounts including a statement of costs incurred by the Governments providing the services for the past three years and the total gross tonnage using the service for the past three years. The accounts shall be publicly available. Within three months after having received the cost statement, contributing Governments may request more detailed information regarding the costs incurred in managing and operating the Ice Patrol.
8. These Rules shall be operative beginning with the ice season of 2002.

**Notice from the Danish Maritime Authority B –
The Construction and Equipment, etc. of Ships**

Chapter B VI

Carriage of cargoes

Regulation 1 – Application	1
Regulation 2 – Cargo information	2
Regulation 3 – Oxygen analysis and gas detection equipment.....	2
Regulation 4 – The use of pesticides in ships	2
Regulation 5 – Stowage and securing	3
Regulation 6 – Acceptance criteria for shipment.....	3
Regulation 7 – Loading, unloading and stowage of bulk cargoes	4
Regulation 8 – Definitions	5
Regulation 9 – Requirements for cargo ships carrying grain.....	5

Part A – General provisions

Regulation 1 – Application

1. This chapter applies to the carriage of cargoes (except liquids in bulk, gases in bulk and those aspects of carriage covered by other chapters) which, owing to their particular hazards to ships or persons on board, may require special precautions in all ships to which the present regulations (*Notice B from the Danish Maritime Authority*) apply and in cargo ships of less than 500 gross tonnage. However, for cargo ships of less than 500 gross tonnage, the Administration, if it considers that the sheltered nature and conditions of voyage are such as to render the application of any specific requirements of part A or B of this chapter unreasonable or unnecessary, may take other effective measures to ensure the required safety for these ships.
2. To supplement the provisions of parts A and B of this chapter, each Contracting Government shall ensure that appropriate information on cargo and its stowage and securing is provided, specifying, in particular, precautions necessary for the safe carriage of such cargoes.¹

¹ Refer to:

.1 the Code of Safe Practice for Cargo Stowage and Securing adopted by the Organization by resolution A.714(17), as amended;

.2 the Code of Safe Practice for Ships Carrying Timber Deck Cargoes adopted by the Organization by resolution A.715(17), as amended; MSC/Circ.525, Guidance note on precautions to be taken by the masters of ships of below 100 metres in length engaged in the carriage of logs; and MSC/Circ.548, Guidance note on precautions to be taken by masters of ships engaged in the carriage of timber cargoes; and

.3 the Code of Safe Practice for Solid Bulk Cargoes (BC Code) adopted by the Organization by resolution A.434(XI), as amended.

Regulation 2 – Cargo information

1. The shipper shall provide the master or his representative with appropriate information on the cargo in due time in advance of loading to enable the necessary precautions for proper stowage and safe carriage of the cargo to be put into effect. Such information² shall be confirmed in writing³ and by appropriate shipping documents prior to loading the cargo.
2. The cargo information shall include:
 - 2.1. in the case of general cargo, and of cargo carried in cargo units, a general description of the cargo, the gross mass of the cargo or of the cargo units, and any relevant special properties of the cargo. For the purpose of this regulation the cargo information required in sub-chapter 1.9 of the Code of Safe Practice for Cargo Stowage and Securing, adopted by the Organization by resolution A.714 (17), as amended, shall be provided. Any amendment to subchapter 1.9 shall be adopted, brought into force and take effect in accordance with the provisions of article VIII of the SOLAS Convention concerning the amendment procedures applicable to the annex other than chapter I;
 - 2.2. in the case of bulk cargo, information on the stowage factor of the cargo, the trimming procedures, likelihood of shifting including angle of repose, if applicable, and any other relevant special properties. In the case of a concentrate or other cargo which may liquefy, additional information in the form of a certificate on the moisture content of the cargo and its transportable moisture limit.
 - 2.3. in the case of a bulk cargo not classified in accordance with the provisions of the IMDG Code as defined in regulation VII/1.1, but which has chemical properties that may create a potential hazard, in addition to the information required by the preceding subparagraphs, information on its chemical properties.
3. Prior to loading cargo units on board ships, the shipper shall ensure that the gross mass of such units is in accordance with the gross mass declared on the shipping documents.

Regulation 3 – Oxygen analysis and gas detection equipment

1. When transporting a bulk cargo which is liable to emit a toxic or flammable gas, or cause oxygen depletion in the cargo space, an appropriate instrument for measuring the concentration of gas or oxygen in the air shall be provided together with detailed instructions for its use. Such an instrument shall be to the satisfaction of the Administration.
2. The Administration shall take steps to ensure that crews of ships are trained in the use of such instruments.

Regulation 4 – The use of pesticides in ships⁴

Appropriate precautions shall be taken in the use of pesticides in ships, in particular for the purposes of fumigation.

¹ The relevant provisions in Resolution A.863(20), the Code of Safe Practice for Solid Bulk Cargoes (BC-Code).

² Refer to MSC/Circ.663, Form for cargo information.

³ Reference to documents in this regulation does not preclude the use of electronic data processing (EDP) and electronic data interchange (EDI) transmission techniques as an aid to paper documentation.

⁴ Refer to the IMO Recommendation on the Safe Use of Pesticides in ships, as amended, *which has been introduced for Danish ships through Technical Regulation no. 9 of 18 August 2000 on the use of pesticides in ships.*

Regulation 5 – Stowage and securing

1. Cargoes, cargo units⁵ and cargo transport units⁶ carried on or below deck shall be so loaded, stowed and secured as to prevent as far as is practicable, throughout the voyage, damage or hazard to the ship and the persons on board, and loss of cargo overboard.
2. Cargo, cargo units and cargo transport units shall be so packed and secured within the unit as to prevent, throughout the voyage, damage or hazard to the ship and the persons on board.
3. Appropriate precautions shall be taken during loading and transport of heavy cargoes or cargoes with abnormal physical dimensions to ensure that no structural damage to the ship occurs and to maintain adequate stability throughout the voyage.
4. Appropriate precautions shall be taken during loading and transport of cargo units and cargo transport units on board ro-ro ships, particularly with regard to the lashing arrangements on board such ships and on the cargo units and cargo transport units and with regard to the strength of the lashing points and lashings.
5. Freight containers shall not be loaded to more than the maximum gross weight indicated on the Safety Approval Plate under the International Convention for Safe Containers (CSC), as amended.
6. All cargoes, other than solid and liquid bulk cargoes, cargo units and cargo transport units, shall be loaded, stowed and secured throughout the voyage in accordance with the Cargo Securing Manual approved by the Administration. In ships with ro-ro spaces, as defined in regulation II-2/3.41, all securing of such cargoes, cargo units and cargo transport units, in accordance with the Cargo Securing Manual, shall be completed before the ship leaves the berth. The Cargo Securing Manual shall be drawn up to a standard at least equivalent to relevant guidelines developed by the Organization⁷.

Regulation 5-1 – Material safety data sheets

Ships carrying MARPOL Annex I cargoes, as defined in Appendix I to Annex I of the Protocol of 1978 relating to the International Convention for the Prevention of Pollution from Ships, 1973, and marine fuel oils shall be provided with a material safety data sheet prior to the loading of such cargoes based on the recommendations developed by the Organization.⁸

Part B – Special provisions for bulk cargoes other than grain

Regulation 6 – Acceptance criteria for shipment

1. Prior to loading a bulk cargo, the master shall be in possession of comprehensive information on the ship's stability and on the distribution of cargo for the standard loading conditions. The method of providing such information shall be to the satisfaction of the Administration.⁹

⁵ Refer to the Code of Safe Practice for Cargo Stowage and Securing, adopted by the Organization by resolution A.714(17), as amended.

⁶ Refer to the International Maritime Dangerous Goods (IMDG) Code, adopted by the Organization by resolution MSC.122(75)

⁷ Refer to MSC/Circ.745, Guidelines for the preparation of the Cargo Securing Manual.

⁸ Refer to the Recommendation for material safety data sheets (MSDS) for MARPOL Annex I cargoes and marine fuel oils, adopted by the Organization by resolution MSC.150(77), as may be amended.

⁹ Refer to the Recommendation on intact stability for all ship types subject to the IMO instruments, adopted by the Organization by resolution A.749(18) and amended by resolution MSC.75(69). Furthermore, reference is made to MSC/Circ. 456, model Loading and Stability Manual, MSC/Circ. 706, Guidance on intact stability of existing tankers

2. Concentrates or other cargoes which may liquefy shall only be accepted for loading when the actual moisture content of the cargo is less than its transportable moisture limit. However, such concentrates and other cargoes may be accepted for loading even when their moisture content exceeds the above limit, provided that safety arrangements to the satisfaction of the Administration are made to ensure adequate stability in case of cargo shifting and further provided that the ship has adequate structural integrity.
3. Prior to loading a bulk cargo which is not a cargo classified in accordance with the provisions of the IMDG Code, as defined in regulation VII/1.1 but which has chemical properties that may create a potential hazard, special precautions for its safe carriage shall be taken.

Regulation 7 – Loading, unloading and stowage of bulk cargoes¹⁰

1. For the purpose of this regulation, “terminal representative” means a person appointed by the terminal or other facility, where the ship is loading or unloading, who has responsibility for operations conducted by that terminal or facility with regard to the particular ship.
2. To enable the master to prevent excessive stresses in the ship's structure, the ship shall be provided with a booklet, which shall be written in a language with which the ship's officers responsible for cargo operations are familiar. If this language is not English, the ship shall be provided with a booklet written also in the English language. The booklet shall, as a minimum, include:
 - 2.1. stability data, as required by regulation II-1/22 ;
 - 2.2. ballasting and deballasting rates and capacities;
 - 2.3. maximum allowable load per unit surface area of the tank top plating;
 - 2.4. maximum allowable load per hold;
 - 2.5. general loading and unloading instructions with regard to the strength of the ship's structure including any limitations on the most adverse operating conditions during loading, unloading, ballasting operations and the voyage;
 - 2.6. any special restrictions such as limitations on the most adverse operating conditions imposed by the Administration or organization recognized by it, if applicable; and
 - 2.7. where strength calculations are required, maximum permissible forces and moments on the ship's hull during loading, unloading and the voyage.
3. Before a solid bulk cargo is loaded or unloaded, the master and the terminal representative shall agree on a plan¹¹ which shall ensure that the permissible forces and moments on the ship are not exceeded during loading or unloading, and shall include the sequence, quantity and rate of loading or unloading, taking into consideration the speed of loading or unloading, the number of pours and the deballasting or ballasting capability of the ship. The plan and any subsequent amendments thereto shall be lodged with the appropriate authority of the port State.
4. Bulk cargoes shall be loaded and trimmed reasonably level, as necessary, to the boundaries of the cargo space so as to minimize the risk of shifting and to ensure that adequate stability will be maintained throughout the voyage.

during liquid transfer operations, and MSC/Circ.707, Guidance to the master for avoiding dangerous situations in adverse weather and sea conditions. In addition, reference is made to the latest Guidance on the approval of ship stability issued by the Danish Maritime Authority.

¹⁰ Refer to the Code of Practice for the Safe Loading and Unloading of Bulk Carriers (BLU Code) adopted by the Organization by resolution A.862(20).

¹¹ Refer to IMO Res. A.862(20), Code of Practice for the Safe Loading and unloading of Bulk Carriers (BLU Code).

5. When bulk cargoes are carried in 'tween-decks, the hatchways of such 'tween-decks shall be closed in those cases where the loading information indicates an unacceptable level of stress of the bottom structure if the hatchways are left open. The cargo shall be trimmed reasonably level and shall either extend from side to side or be secured by additional longitudinal divisions of sufficient strength. The safe load-carrying capacity of the 'tween-decks shall be observed to ensure that the deck-structure is not overloaded.
6. The master and terminal representative shall ensure that loading and unloading operations are conducted in accordance with the agreed plan.
7. If during loading or unloading any of the limits of the ship referred to in paragraph 2 are exceeded or are likely to become so if the loading or unloading continues, the master has the right to suspend operation and the obligation to notify accordingly the appropriate authority of the port State with which the plan has been lodged. The master and the terminal representative shall ensure that corrective action is taken. When unloading cargo, the master and terminal representative shall ensure that the unloading method does not damage the ship's structure.
8. The master shall ensure that ship's personnel continuously monitor cargo operations. Where possible, the ship's draught shall be checked regularly during loading or unloading to confirm the tonnage figures supplied. Each draught and tonnage observation shall be recorded in a cargo log-book. If significant deviations from the agreed plan are detected, cargo or ballast operations or both shall be adjusted to ensure that the deviations are corrected.

Part C – Carriage of grain

Regulation 8 – Definitions

For the purposes of this part, unless expressly provided otherwise:

1. “International Grain Code” means the International Code for the Safe Carriage of Grain in Bulk adopted by the Maritime Safety Committee of the Organization by resolution MSC.23(59) as may be amended by the Organization, provided that such amendments are adopted, brought into force and take effect in accordance with the provisions of article VIII of the SOLAS Convention concerning the amendment procedures applicable to the annex other than chapter I.
2. The term “grain” includes wheat, maize (corn), oats, rye, barley, rice, pulses, seeds and processed forms thereof whose behaviour is similar to that of grain in its natural state.

Regulation 9 – Requirements for cargo ships carrying grain

1. In addition to any other applicable requirements of the present regulations, a cargo ship carrying grain shall comply with the requirements of the International Grain Code, and hold a document of authorization as required by that Code. For the purpose of this regulation, the requirements of the Code shall be treated as mandatory.
2. A ship without such a document shall not load grain until the master satisfies the Administration, or the Contracting Government of the port of loading on behalf of the Administration, that the ship will comply with the requirements of the International Grain Code in its proposed loaded condition.

Notice from the Danish Maritime Authority B – The Construction and Equipment, etc. of Ships

Chapter B VII

Carriage of dangerous goods

Regulation 1 – Definitions	1
Regulation 2 – Application	2
Regulation 3 – Requirements for the carriage of dangerous goods	2
Regulation 4 – Documents	2
Regulation 5 – Cargo Securing Manual	3
Regulation 6 – Reporting of incidents involving dangerous goods	3
Regulation 7 – Definitions	4
Regulation 7-1 – Application	4
Regulation 7-2 – Documents	5
Regulation 7-3 – Stowage and segregation requirements	5
Regulation 7-4 – Reporting of incidents involving dangerous goods	6
Regulation 8 – Definitions	6
Regulation 9 – Application to chemical tankers	7
Regulation 10 – Requirements for chemical tankers	7
Regulation 11 – Definitions	7
Regulation 12 – Application to gas carriers	8
Regulation 13 – Requirements for gas carriers	8
Regulation 14 – Definitions	9
Regulation 15 – Application to ships carrying INF cargo	9
Regulation 16 – Requirements for ships carrying INF cargo	10

Part A – Carriage of dangerous goods in packaged form

Regulation 1 – Definitions

For the purpose of this chapter, unless expressly provided otherwise:

1. “IMDG Code” means the International Maritime Dangerous Goods (IMDG) Code adopted by the Maritime Safety Committee of the Organization by resolution MSC.122(75), as may be amended by the Organization, provided that such amendments are adopted, brought into force and take effect in accordance with the provisions of article VIII of the present Convention concerning the amendment procedures applicable to the annex other than chapter 1.
2. “Dangerous goods” mean the substances, materials and articles covered by the IMDG Code.
3. “Packaged form” means the form of containment specified in the IMDG Code.

Regulation 2 – Application¹⁾

1. Unless expressly provided otherwise, this part applies to the carriage of dangerous goods in packaged form in all ships to which the present regulations apply and in cargo ships of less than 500 gross tonnage.
2. The provisions of this part do not apply to ships' stores and equipment.
3. The carriage of dangerous goods in packaged form is prohibited except in accordance with the provisions of this chapter.
4. To supplement the provisions of this part, each Contracting Government shall issue, or cause to be issued, detailed instructions on emergency response and medical first aid relevant to incidents involving dangerous goods in packaged form, taking into account the guidelines developed by the Organization.²⁾
5. *As an alternative to the IMDG Code, the “Memorandum on the carriage of dangerous goods by ro-ro ships in the Baltic area” (the “Baltic Agreement”, also referred to as the “Baltic Memorandum”) may be used within the areas stipulated in the memorandum.*
6. *The IMDG Code, as amended³⁾, as well as the guidelines stipulated in paragraph 4 shall be available on board all ships⁴⁾ carrying dangerous goods in packaged form.*

Regulation 3 – Requirements for the carriage of dangerous goods

The carriage of dangerous goods in packaged form shall be in compliance with the relevant provisions of the IMDG Code.

The amendment of the IMDG Code most recently adopted by the Organisation and put into force shall be used; however, the adopted version of the IMDG Code may be used for an implementation period of one year until the relevant version enters into force internationally.

Regulation 4 – Documents⁵⁾

1. In all documents relating to the carriage of dangerous goods in packaged form by sea, the Proper Shipping Name of the goods⁶⁾ shall be used (trade names alone shall not be used) and the correct description given in accordance with the classification set out in the IMDG Code.
2. The transport documents prepared by the shipper shall include, or be accompanied by, a signed certificate or a declaration that the consignment, as offered for carriage, is properly packaged, marked, labelled or placarded, as appropriate, and in proper condition for carriage.

¹⁾ Refer to:

.1 part D, which contains special requirements for the carriage of INF cargo; and

.2 regulation II-2/19, which contains special requirements for ships carrying dangerous goods.

²⁾ Refer to:

.1 the “Emergency Response Procedures for Ships Carrying Dangerous Goods (EmS Guide)” (MSC/Circ.1025); and

.2 the “Medical First Aid Guide for Use in Accidents Involving Dangerous Goods” (MFAG) (MSC/Circ.857) published by the Organization.

³⁾ Reference is made to the IMDG Code as adopted by the Organisation by MSC resolution 122/75).

⁴⁾ The regulations and guidelines mentioned may be in electronic format, such as a CD-rom.

⁵⁾ *References to documents in this regulations shall not preclude the use of digital systems as support in connection with paper documentation.*

⁶⁾ *In English “proper shipping name”.*

3. The person(s) responsible for the packing/loading of dangerous goods in a cargo transport unit⁷⁾ shall provide a signed container/vehicle packing certificate stating that the cargo in the unit has been properly packed and secured and that all applicable transport requirements have been met. Such a certificate may be combined with the document referred to in paragraph 2.
4. Where there is due cause to suspect that a cargo transport unit in which dangerous goods are packed is not in compliance with the requirements of paragraph 2 or 3, or where a container/vehicle packing certificate is not available, the cargo transport unit shall not be accepted for carriage.
5. Each ship carrying dangerous goods in packaged form shall have a special list or manifest setting forth, in accordance with the classification set out in the IMDG Code, the dangerous goods on board and the location thereof. A detailed stowage plan, which identifies by class and sets out the location of all dangerous goods on board may be used in place of such a special list or manifest. A copy of one of these documents shall be made available before departure to the person or organization designated by the port State authority.
6. *In ships carrying dangerous goods in packaged form, information about the goods and about the measures to be taken in case of accidents with the goods shall be available to the crew.*

Regulation 5 – Cargo Securing Manual

Cargo, cargo units⁸⁾ and cargo transport units shall be loaded, stowed and secured throughout the voyage in accordance with the Cargo Securing Manual approved by the Administration. The Cargo Securing Manual shall be drawn up to a standard at least equivalent to the guidelines developed by the Organization.⁹⁾

Regulation 6 – Reporting of incidents involving dangerous goods

1. When an incident takes place involving the loss or likely loss overboard of dangerous goods in packaged form into the sea, the master, or other person having charge of the ship, shall report the particulars of such an incident without delay and to the fullest extent possible to the nearest coastal State. The report shall be drawn up based on general principles and guidelines developed by the Organization.¹⁰⁾
2. In the event of the ship referred to in paragraph 1 being abandoned, or in the event of a report from such as ship being incomplete or unobtainable, the company, as defined in regulation IX/1.2, shall, to the fullest extent possible, assume the obligations placed upon the master by this regulation.

Part AA – Carriage of dangerous goods in packaged form by ro/ro ships

Regulation I – Special provisions for ro/ro ships

1. *In passenger ships and in ro-ro cargo ships carrying ro-ro goods in accordance with the memorandum on the carriage of dangerous goods by ro-ro ships in the Baltic, the master shall,*

⁷⁾ Refer to the International Maritime Dangerous Goods (IMDG) Code, adopted by the Organization by resolution MSC.122(75).

⁸⁾ As defined in the Code of Safe Practice for Cargo Stowage and Securing, adopted by the Organization by resolution A.715(17), as amended.

⁹⁾ Refer to the Guidelines for the preparation of the Cargo Securing Manual (MSC/Circ.745).

¹⁰⁾ Refer to the General principles for ship reporting systems and ship reporting requirements, including Guidelines for reporting incidents involving dangerous goods, harmful substances and/or marine pollutants, adopted by the Organization by resolution A.851(20).

with a view to proper stowage of dangerous goods, prior to boarding of vehicles, check the nature of goods in all ro-ro units, lorries, trailers, railway wagons and the like. This check of the nature of the goods may be carried out on the basis of the documentation/declaration pertaining to the ro-ro unit and the marking of the unit or on the basis of a declaration issued by the lorry driver, railway personnel or terminal personnel to the effect that the unit does not contain dangerous goods. The above check may, however, be omitted if a proper system has been established for the sorting and control of the goods before boarding. Information on such arrangements in Denmark shall, before the check can be dispensed with, be submitted to the Danish Maritime Authority.

2. *With regard to tank lorries, railway tank wagons or tank containers that contain dangerous goods or have not been cleaned since they last contained dangerous goods, in addition to the declaration referred to in regulation 4, paragraph 2, a declaration shall be presented on boarding issued by the lorry driver, the railway personnel or the terminal personnel, stating that the wagon or container was tight immediately prior to boarding. If the wagon or container is provided with durable marking referring to its dangerous goods content, even though it has been cleaned or has not most recently contained dangerous goods, a corresponding declaration hereof shall be issued.*
3. *With regard to lorries and trailers, railway wagons or containers containing dangerous goods – including, if applicable, various kinds of dangerous goods – in addition to the declaration referred to in regulation 4, paragraph 2, a declaration shall be presented on boarding issued by the lorry driver, the railway personnel or the terminal personnel to the effect that the wagon or container was correctly stowed immediately prior to the boarding. If the wagon or container is provided with durable marking referring to its dangerous goods content, however empty, a corresponding declaration shall be issued.*

Regulation II – Control

1. *The master shall, with the exception of the cases referred to in regulation 1, see to it that dangerous goods are marked as prescribed and that the visible part of the packaging complies with the regulations on packaging.*

Part A-1 – Carriage of dangerous goods in solid form in bulk

Regulation 7 – Definitions

“Dangerous goods in solid form in bulk” means any material, other than liquid or gas, consisting of a combination of particles, granules or any larger pieces of material, generally uniform in composition, which is covered by *the BC Code*¹¹⁾ or by the IMDG Code and is loaded directly into the cargo spaces of a ship without any intermediate form of containment, and includes such materials loaded in a barge on a barge-carrying ship.

Regulation 7-1 – Application¹²⁾

1. Unless expressly provided otherwise, this part applies to the carriage of dangerous goods in solid form in bulk in all ships to which the present regulations apply and in cargo ships of less than 500 gross tonnage.

¹¹⁾ Reference is made to the Code of Safe Practice for Solid Bulk Cargoes (BC Code) adopted by the Organisation by resolution A.434(XI), as amended.

¹²⁾ Refer to regulation II-2/19, which contains special requirements for ships carrying dangerous goods

2. The carriage of dangerous goods in solid form in bulk is prohibited except in accordance with the provisions of this part.
3. To supplement the provisions of this part, each Contracting Government shall issue, or cause to be issued, detailed instructions on the safe carriage of dangerous goods in solid form in bulk¹³⁾ which shall include instructions on emergency response and medical first aid relevant to incidents involving dangerous goods in solid form in bulk, taking into account the guidelines developed by the Organization.¹⁴⁾
4. *The following regulations shall be available on board all ships carrying dangerous goods in solid form in bulk:*
 - 4.1. *The IMDG-Code, as amended. With regard to ships that carry dangerous goods only in exceptional cases or frequently carry particular kinds of dangerous goods, it will, however, be sufficient if only the information from the IMDG Code necessary for the safe carriage of the goods in question is on board.*
 - 4.2. *The BC Code as amended. With regard to ships that carry dangerous goods only in exceptional cases or frequently carry particular kinds of dangerous goods, it will, however, be sufficient if only the information from the BC Code necessary for the safe carriage of the goods in question is on board.*
 - 4.3. *Medical First Aid Guide for Use in Accidents Involving Dangerous Goods (MFAG), as amended.*

Regulation 7-2 – Documents¹⁵⁾

1. In all documents relating to the carriage of dangerous goods in solid form in bulk by sea, the bulk cargo shipping name of the goods shall be used (trade names alone shall not be used). *Where the dangerous goods are provided with a UN number of a BC number, this shall be stated in the document.*
2. Each ship carrying dangerous goods in solid form in bulk shall have a special list or manifest setting forth the dangerous goods on board and the location thereof. A detailed stowage plan, which identifies by class and sets out the location of all dangerous goods on board, may be used in place of such a special list or manifest. A copy of one of these documents shall be made available before departure to the person or organization designated by the port State authority.
3. *In ships carrying dangerous goods in solid form in bulk, information about the goods and about the measures to be taken in case of accidents with the goods shall be available to the crew.¹⁶⁾*

Regulation 7-3 – Stowage and segregation requirements

1. Dangerous goods in solid form in bulk shall be loaded and stowed safely and appropriately in accordance with the nature of the goods. Incompatible goods shall be segregated from one another.

¹³⁾ Refer to the Code of Safe Practice for Solid Bulk Cargoes (BC Code), adopted by the Organization by resolution A.434 (XI), as amended.

¹⁴⁾ Refer to the Medical First Aid and the Medical First Aid Guide for Use in Accidents involving Dangerous Goods (MFAG) (MSC/ Circ.857).

¹⁵⁾ *References to documents in this regulations shall not preclude the use of digital systems as support in connection with paper documentation.*

¹⁶⁾ *Reference is made to regulation 5 of chapter II C of Technical Regulation A on occupational health in ships as regards carcinogenics.*

2. Dangerous goods in solid form in bulk, which are liable to spontaneous heating or combustion, shall not be carried unless adequate precautions have been taken to minimize the likelihood of the outbreak of fire.
3. Dangerous goods in solid form in bulk, which give off dangerous vapours, shall be stowed in a well ventilated cargo space.
4. *The amendment of the IMDG Code and of the BC Code most recently adopted by the Organisation and put into force shall be used; however, the adopted version of the IMDG Code may be used for an implementation period of one year until the relevant version enters into force internationally.*¹⁷⁾

Regulation 7-4 – Reporting of incidents involving dangerous goods

1. When an incident takes place involving the loss or likely loss overboard of dangerous goods in solid form in bulk into the sea, the master, or other person having charge of the ship, shall report the particulars of such an incident without delay and to the fullest extent possible to the nearest coastal State. The report shall be drawn up based on general principles and guidelines developed by the Organization.¹⁸⁾
2. In the event of the ship referred to in paragraph 1 being abandoned, or in the event of a report from such a ship being incomplete or unobtainable, the company, as defined in regulation IX/1.2, shall to the fullest extent possible, assume the obligations placed upon the master by this regulation.

Part B – Construction and equipment of ships carrying dangerous liquid chemicals in bulk

Regulation 8 – Definitions

For the purpose of this part, unless expressly provided otherwise:

1. “International Bulk Chemical Code (IBC Code)” means the International Code for the Construction and Equipment of Ships Carrying Dangerous Chemicals in Bulk adopted by the Maritime Safety Committee of the Organization by resolution MSC.4(48), as may be amended by the Organization, provided that such amendments are adopted, brought into force and take effect in accordance with the provisions of article VIII of the SOLAS Convention concerning the amendment procedures applicable to the annex other than chapter I.
2. “Chemical tanker” means a cargo ship constructed or adapted and used for the carriage in bulk of any liquid product listed in chapter 17 of the International Bulk Chemical Code.
3. For the purpose of regulation 9, “ship constructed” means a ship the keel of which is laid or which is at a similar stage of construction.
4. “At a similar stage of construction” means the stage at which:
 - 4.1. construction identifiable with a specific ship begins; and
 - 4.2. assembly of that ship has commenced comprising at least 50 tonnes or 1% of the estimated mass of all structural material, whichever is less.

¹⁷⁾ Reference is made to the IMDG Code adopted by the Organisation by MSC resolution 122(75).

¹⁸⁾ Refer to the General principles for ship reporting systems and ship reporting requirements, including Guidelines for reporting incidents involving dangerous goods, harmful substances and/or marine pollutants, adopted by the Organization by resolution A.851(20).

Regulation 9 – Application to chemical tankers

1. Unless expressly provided otherwise, this part applies to chemical tankers constructed on or after 1 July 1986 including those of less than 500 gross tonnage. Such tankers shall comply with the requirements of this part in addition to any other applicable requirements of the present regulations.
2. Any chemical tanker, irrespective of the date of construction, which undergoes repairs, alterations, modifications and outfitting related thereto shall continue to comply with at least the requirements previously applicable to the ship. Such a ship, if constructed before 1 July 1986, shall, as a rule, comply with the requirements for a ship constructed on or after that date to at least the same extent as before undergoing such repairs, alterations, modifications or outfitting. Repairs, alterations and modifications of a major character, and outfitting related thereto, shall meet the requirements for a ship constructed on or after 1 July 1986 in so far as the Administration deems reasonable and practicable.
3. A ship, irrespective of the date of construction, which is converted to a chemical tanker shall be treated as a chemical tanker constructed on the date on which such conversion commenced.
4. *Existing chemical tankers constructed before 1 July 1986 shall comply with the regulations of the Chemical Code (the BCH Code).*¹⁹⁾

Regulation 10 – Requirements for chemical tankers

1. A chemical tanker shall comply with the requirements of the International Bulk Chemical Code and shall, in addition to the requirements of regulation I/8, I/9, and I/10, as applicable, be surveyed and certified as provided for in that Code.²⁰⁾
2. A chemical tanker holding a certificate issued pursuant to the provisions of paragraph 1 shall be subject to the control established in regulation I/19. For this purpose such certificate shall be treated as a certificate issued under regulation I/12 or I/13.

Part C – Construction and equipment of ships carrying liquefied gases in bulk

Regulation 11 – Definitions

For the purpose of this part, unless expressly provided otherwise:

1. “International Gas Carrier Code (IGC Code)” means the International Code for the Construction and Equipment of Ships Carrying Liquefied Gases in Bulk as adopted by the Maritime Safety Committee of the Organization by resolution MSC.5(48), as may be amended by the Organization, provided that such amendments are adopted, brought into force and take effect in accordance with the provisions of article VIII of the present Convention concerning the amendment procedures applicable to the annex other than chapter I.
2. “Gas carrier” means a cargo ship constructed or adapted and used for the carriage in bulk of any liquefied gas or other product listed in chapter 19 of the International Gas Carrier Code.

¹⁹⁾ Reference is also made to Guidelines for the uniform application of the survival requirements for the Bulk Code and the Gas Carrier Code, MSC/Circ.406.

²⁰⁾ Offshore supply vessels used for carrying limited amounts of dangerous liquid chemicals in bulk may instead comply with the provisions of Resolution A.673(16), Guidelines for the Transport and Handling of Limited Amounts of Hazardous and Noxious Liquid Substances in Bulk on Offshore Support Vessels. The definition of an offshore supply vessel and the delimitation of the cargo amounts are found in these guidelines.

3. For the purpose of regulation 12, “ship constructed” means a ship the keel of which is laid or which is at a similar stage of construction.
4. “At a similar stage of construction” means the stage at which:
 - 4.1. construction identifiable with a specific ship begins; and
 - 4.2. assembly of that ship has commenced comprising at least 50 tonnes or 1% of the estimated mass of all structural material, whichever is less.

Regulation 12 – Application to gas carriers

1. Unless expressly provided otherwise, this part applies to gas carriers constructed on or after 1 July 1986 including those of less than 500 gross tonnage. Such gas carriers shall comply with the requirements of this part in addition to any other applicable requirements of the present regulations.
2. Any gas carrier, irrespective of the date of construction, which undergoes repairs, alterations, modifications and outfitting related thereto shall continue to comply with at least the requirements previously applicable to the ship. Such a ship if constructed before 1 July 1986 shall, as a rule, comply with the requirements for a ship constructed on or after that date to at least the same extent as before undergoing such repairs, alterations, modifications or outfitting. Repairs, alterations and modifications of a major character, and outfitting related thereto, shall meet the requirements for a ship constructed on or after 1 July 1986 in so far as the Administration deems reasonable and practicable.
3. A ship, irrespective of the date of construction, which is converted to a gas carrier shall be treated as a gas carrier constructed on the date on which such conversion commenced.

Regulation 13 – Requirements for gas carriers

1. A gas carrier shall comply with the requirements of the International Gas Carrier Code and shall, in addition to the requirements of regulation I/8, I/9 and I/10, as applicable, be surveyed and certified as provided for in that Code. For the purpose of this regulation, the requirements of the Code shall be treated as mandatory.
2. A gas carrier holding a certificate issued pursuant to the provisions of paragraph 1 shall be subject to the control established in regulation I/19. For this purpose such certificate shall be treated as a certificate issued under regulation I/12 or I/13.

Part CC – Gas tankers – national provisions with regard to ships carrying liquefied gas in bulk

Regulation I – Definitions

The following definitions shall apply in this section:

1. *“Existing gas tanker”*: A ship constructed before 1 July 1986 equipped to carry liquefied gas, as defined in paragraph 1.2.1 of the code for existing gas tankers, and covered by the other provisions in paragraph 1.2 of the code.
2. *“Gas Code”²¹⁾ (GC)*: *“Code for the Construction and Equipment of Ships Carrying Liquefied Gases in Bulk”, issued by the Organisation, as amended.*

²¹⁾ *Guidelines for the uniform application of the survival requirements for the Bulk Code and the Gas Carrier Code, MSC/Circ.406.*

3. *"Gas code for existing tankers": The "Code for Existing Ships Carrying Liquefied Gases in Bulk", issued by the Organisation, as amended.*

Regulation II – General provisions

1. *Existing gas tankers shall comply with the provisions of the Gas Code (GC) or the Code for Existing Gas Tankers, depending on the circumstances.*

Part D – Special requirements for the carriage of packaged irradiated nuclear fuel, plutonium and high-level radioactive wastes on board ships

Regulation 14 – Definitions

For the purpose of this part, unless expressly provided otherwise:

1. "INF Code" means the International Code for the Safe Carriage of Packaged Irradiated Nuclear Fuel, Plutonium and High-Level Radioactive Wastes on Board Ships, adopted by the Maritime Safety Committee of the Organization by resolution MSC.88 (71), as may be amended by the Organization, provided that such amendments are adopted, brought into force and take effect in accordance with the provisions of article VIII of the present Convention concerning the amendment procedures applicable to the annex other than chapter I.
2. "INF cargo" means packaged irradiated nuclear fuel, plutonium and high-level radioactive wastes carried as cargo in accordance with class 7 of the IMDG Code.
3. "Irradiated nuclear fuel" means material containing uranium, thorium and/or plutonium isotopes which has been used to maintain a self-sustaining nuclear chain reaction.
4. "Plutonium" means the resultant mixture of isotopes of that material extracted from irradiated nuclear fuel from reprocessing.
5. "High-level radioactive wastes" means liquid wastes resulting from the operation of the first stage extraction system or the concentrated wastes from subsequent extraction stages, in a facility for reprocessing irradiated nuclear fuel, or solids into which such liquid wastes have been converted.

Regulation 15 – Application to ships carrying INF cargo

1. Except as provided for in paragraph 2, this part shall apply to all ships regardless of the date of construction and size, including cargo ships of less than 500 gross tonnage, engaged in the carriage of INF cargo.
2. This part and the INF Code do not apply to warships, naval auxiliary or other vessels owned or operated by a Contracting Government and used, for the time being, only on government non-commercial service; however, each Administration shall ensure, by the adoption of appropriate measures not impairing operations or operational capabilities of such ships owned or operated by it, that such ships carrying INF cargo act in a manner consistent, so far as reasonable and practicable, with this part and the INF Code.
3. Nothing in this part or the INF Code shall prejudice the rights and duties of governments under international law and any action taken to enforce compliance shall be consistent with international law.

Regulation 16 – Requirements for ships carrying INF cargo

1. A ship carrying INF cargo shall comply with the requirements of the INF Code in addition to any other applicable requirements of the present regulations and shall be surveyed and certified as provided for in that Code.
2. A ship holding a certificate issued pursuant to the provisions of paragraph 1 shall be subject to the control established in regulations I/19 and XI/4. For this purpose, such certificate shall be treated as a certificate issued under regulation I/12 or I/13.

**Notice from the Danish Maritime Authority B – The Construction and Equipment,
etc. of Ships**

**Chapter B VIII
Nuclear Ships**

Regulation 1 – Application	1
Regulation 2 – Application of other chapters	1
Regulation 3 – Exemptions	1
Regulation 4 – Approval of reactor installation	1
Regulation 5 – Suitability of reactor installation for service on board ship	2
Regulation 6 – Radiation safety	2
Regulation 7 – Safety assessment	2
Regulation 8 – Operating manual	2
Regulation 9 – Surveys	2
Regulation 10 – Certificates	2
Regulation 11 – Special control	3
Regulation 12 – Casualties	3

Regulation 1 – Application

This chapter applies to all nuclear ships except ships of war.

Regulation 2 – Application of other chapters

The regulations contained in the other chapters of the present Convention apply to nuclear ships except as modified by this chapter.*)

Regulation 3 – Exemptions

A nuclear ship shall not, in any circumstances, be exempted from compliance with any regulations of this Convention.

Regulation 4 – Approval of reactor installation

The design, construction and standards of inspection and assembly of the reactor installation shall be subject to the approval and satisfaction of the Administration and shall take account of the limitations which will be imposed on surveys by the presence of radiation.

*) Refer to the Code of Safety for Nuclear Merchant Ships (resolution A.491(XII)), which supplements the requirements of this chapter.

Regulation 5 – Suitability of reactor installation for service on board ship

The reactor installation shall be designed having regard to the special conditions of service on board ship both in normal and exceptional circumstances of navigation.

Regulation 6 – Radiation safety

The Administration shall take measures to ensure that there are no unreasonable radiation or other nuclear hazards, at sea or in port, to the crew, passengers or public, or to the waterways or food or water resources. http://10.1.10.213/solas/regulations/chapter_VIII/r6.htm2008-05-08 19.44.20

Regulation 7 – Safety assessment

- (a) A safety assessment shall be prepared to permit evaluation of the nuclear power plant and safety of the ship to ensure that there are no unreasonable radiation or other hazards, at sea or in port, to the crew, passengers or public, or to the waterways or food or water resources. The Administration, when satisfied, shall approve such safety assessment which shall always be kept up to date.
- (b) The safety assessment shall be made available sufficiently in advance to the Contracting Governments of the countries which a nuclear ship intends to visit so that they may evaluate the safety of the ship.

Regulation 8 – Operating manual

A fully detailed operating manual shall be prepared for the information and guidance of the operating personnel in their duties on all matters relating to the operation of the nuclear power plant and having an important bearing on safety. The Administration, when satisfied, shall approve such operating manual and a copy shall be kept on board the ship. The operating manual shall always be kept up to date.

Regulation 9 – Surveys

Survey of nuclear ships shall include the applicable requirements of regulation 7 of chapter I, or of regulations 8, 9 and 10 of chapter I, except in so far as surveys are limited by the presence of radiation. In addition, the surveys shall include any special requirements of the safety assessment. They shall in all cases, notwithstanding the provisions of regulations 8 and 10 of chapter I, be carried out not less frequently than once a year.

Regulation 10 – Certificates

- (a) The provisions of paragraph (a) of regulation 12 of chapter I and of regulation 14 of chapter I shall not apply to nuclear ships.
- (b) A certificate, called a Nuclear Passenger Ship Safety Certificate shall be issued after inspection and survey to a nuclear passenger ship which complies with the requirements of chapters II-1, II-2, III, IV and VIII, and any other relevant requirements of the present regulations.
- (c) A certificate, called a Nuclear Cargo Ship Safety Certificate shall be issued after inspection and survey to a nuclear cargo ship which satisfies the requirements for cargo ships on survey set out in regulation 10 of chapter I, and complies with the requirements of chapters II-1, II-2, III, IV and VIII and any other relevant requirements of the present regulations.

- (d) Nuclear Passenger Ship Safety Certificates and Nuclear Cargo Ship Safety Certificates shall state: "That the ship, being a nuclear ship, complied with all requirements of chapter VIII of the Convention and conformed to the Safety Assessment approved for the ship".
- (e) Nuclear Passenger Ship Safety Certificates and Nuclear Cargo Ship Safety Certificates shall be valid for a period of not more than 12 months.
- (f) Nuclear Passenger Ship Safety Certificates and Nuclear Cargo Ship Safety Certificates shall be issued either by the Administration or by any person or organization duly authorized by it. In every case, that Administration assumes full responsibility for the certificate.

Regulation 11 – Special control^{*)}

In addition to the control established by regulation 19 of chapter I, nuclear ships shall be subject to special control before entering the ports and in the ports of Contracting Governments, directed towards verifying that there is on board a valid Nuclear Ship Safety Certificate and that there are no unreasonable radiation or other hazards at sea or in port, to the crew, passengers or public, or to the waterways or food or water resources.

Regulation 12 – Casualties

In the event of any accident likely to lead to an environmental hazard the master of a nuclear ship shall immediately inform the Administration. The master shall also immediately inform the competent governmental authority of the country in whose waters the ship may be, or whose waters the ship approaches in a damaged condition.

^{*)} Refer to the IMO/IAEA Safety Recommendation on the Use of Ports by Nuclear Merchant Ships.

**Notice from the Danish Maritime Authority B –
The Construction and Equipment, etc. of Ships
Chapter B IX
Management for the safe operation of ships¹**

Regulation 1 – Definitions	1
Regulation 2 – Application	2
Regulation 3 – Safety management requirements.....	2
Regulation 4 – Certification	3
Regulation 5 – Maintenance of conditions	3
Regulation 6 – Verification and control.....	3

Introduction

This chapter contains the provisions of Annex IX of the International Convention for the Safety of Life at Sea (SOLAS) 1974, as amended, and associated protocols and codes. The provisions of this chapter apply in pursuance of Regulation (EC) No. 336/2006 of the European Parliament and of the Council of 15 February 2006 on the implementation of the International Safety Management Code within the Community and repealing Council Regulation (EC) No. 3051/95. Furthermore, reference is made to Technical Regulation no. 1 of 8 February 2007 issued by the Danish Maritime Authority on the administration of the said regulation.

The provisions of this chapter are reprinted for information purposes and to retain the entirety of the SOLAS provisions. They apply to passenger ships engaged on international voyages as well as to cargo ships and MODUs with a gross tonnage of or above 500.

Special attention is drawn to the fact that the application of the Regulation is solely based on tonnage limits under the International Convention on Tonnage Measurement of Ships, 1969.

Regulation 1 – Definitions

For the purpose of this chapter, unless expressly provided otherwise:

1. “International Safety Management (ISM) Code” means the International Management Code for the Safe Operation of Ships and for Pollution Prevention adopted by the Organization by resolution A.741(18), as may be amended by the Organization², provided that such amendments are adopted, brought into force and take effect in accordance with the provisions of article VIII of the present Convention concerning the amendment procedures applicable to the annex other than chapter I.

¹ As regards interpretations and administrative provisions in connection with the ISM Code, reference is made to IMO Resolution A.913(22), " Revised guidelines on Implementation of the International Safety Management (ISM) Code by Administrations.

² As amended most recently by resolution MSC.273(85).

2. “Company” means the owner of the ship or any other organization or person such as the manager, or the bareboat charterer, who has assumed the responsibility for operation of the ship from the owner of the ship and who on assuming such responsibility has agreed to take over all the duties and responsibilities imposed by the International Safety Management Code.
3. “Oil tanker” means an oil tanker as defined in regulation II-1/2.22.
4. “Chemical tanker” means a chemical tanker as defined in regulation VII/8.2.
5. “Gas carrier” means a gas carrier as defined in regulation VII/11.2.
6. “Bulk carrier” means a ship which is constructed generally with single deck, top-side tanks and hopper side tanks in cargo spaces, and is intended primarily to carry dry cargo in bulk, and includes such types as ore carriers and combination carriers.³
7. “Mobile offshore drilling unit (MODU)” means a vessel capable of engaging in drilling operations for the exploration for or exploitation of resources beneath the sea-bed such as liquid or gaseous hydrocarbons, sulphur or salt.
8. “High-speed craft” means a craft as defined in regulation X/1.1.
9. *Document of Compliance (DOC) means a document issued to a shipping company that complies with the requirements of the ISM Code.*⁴
10. *Safety Management Certificate (SMC) means a certificate issued to a ship stating that the shipping company and its ship are operated in accordance with the approved Safety Management System (SMS).*⁵

Regulation 2 – Application⁶

1. This chapter applies to ships, regardless of the date of construction, as follows:
 - 1.1. passenger ships including passenger high-speed craft, not later than 1 July 1998;
 - 1.2. oil tankers, chemical tankers, gas carriers, bulk carriers and cargo high-speed craft of 500 gross tonnage and upwards, not later than 1 July 1998; and
 - 1.3. other cargo ships and mobile offshore drilling units of 500 gross tonnage and upwards, not later than 1 July 2002.⁷
2. This chapter does not apply to government-operated ships used for non-commercial purposes.

Regulation 3 – Safety management requirements

1. The company and the ship shall comply with the requirements of the International Safety Management Code. For the purpose of this regulation, the requirements of the Code shall be treated as mandatory.
2. The ship shall be operated by a company holding a Document of Compliance referred to in regulation 4.

³ As laid down by resolution MSC.277(85).

⁴ As laid down in IMO resolution A.788(19), paragraph 1.1.5.

⁵ As laid down in IMO resolution A.788(19), paragraph 1.1.6.

⁶ Refer to MSC.1/Circ.1231 on Interim Scheme for the compliance of certain cargo ships and special purpose ships with the Management for the safe operations of ships.

⁷ The Maritime Safety Committee, at its 66th session, decided that mobile offshore drilling units not propelled by mechanical means need not comply with the requirements of this chapter.

Regulation 4 – Certification

1. A Document of Compliance shall be issued to every company which complies with the requirements of the International Safety Management Code. This document shall be issued by the Administration, by an organization recognized by the Administration, or at the request of the Administration by another Contracting Government.
2. A copy of the Document of Compliance shall be kept on board the ship in order that the master can produce it on request for verification.
3. A Certificate, called a Safety Management Certificate, shall be issued to every ship by the Administration or an organization recognized by the Administration. The Administration or organization recognized by it shall, before issuing the Safety Management Certificate, verify that the company and its shipboard management operate in accordance with the approved safety management system.

Regulation 5 – Maintenance of conditions

The safety management system shall be maintained in accordance with the provisions of the International Safety Management Code.

Regulation 6 – Verification and control⁸

1. The Administration, another Contracting Government at the request of the Administration or an organization recognized by the Administration shall periodically verify the proper functioning of the ship's safety management system.
2. A ship required to hold a certificate issued pursuant to the provisions of regulation 4.3 shall be subject to control in accordance with the provisions of regulation XI/4. For this purpose such certificate shall be treated as a certificate issued under regulation I/12 or I/13.

⁸ Refer to MSC/Circ.1059 – MEPC/Circ.401 on Procedures concerning observed ISM Code major non-conformities and to MSC-MEPC.2/Circ.2 on IMO requirements on carriage of publications on board ships.

**Notice from the Danish Maritime Authority B –
The Construction and Equipment, etc. of Ships**

Chapter B X

Safety measures for high-speed craft

Regulation 1 – Definitions	1
Regulation 2 – Application	2
Regulation 3 – Requirements for high-speed craft,	2

Regulation 1 – Definitions

For the purpose of this chapter:

1. “High-Speed Craft Code, 1994 (1994 HSC Code)” means the International Code of Safety for High-Speed Craft adopted by the Maritime Safety Committee of the Organization by resolution MSC.36(63), as may be amended by the Organization, provided that such amendments are adopted, brought into force and take effect in accordance with the provisions of article VIII of the present Convention concerning the amendment procedures applicable to the annex other than chapter I.¹⁾
2. “High-Speed Craft Code, 2000 (2000 HSC Code)” means the International Code of Safety for High-Speed Craft, 2000, adopted by the Maritime Safety Committee of the Organization by resolution MSC.97(73), as may be amended by the Organization, provided that such amendments are adopted, brought into force and take effect in accordance with the provisions of article VIII of the present Convention concerning the amendment procedures applicable to the annex other than chapter I.²⁾
3. “High-speed craft” is a craft capable of a maximum speed, in metres per second (m/s), equal to or exceeding:

$$3.73 \nabla^{0.1667}$$

where:

∇ = volume of displacement corresponding to the design waterline (m³),

excluding craft the hull of which is supported completely clear above the water surface in non displacement mode by aerodynamic forces generated by ground effect.

¹⁾ The 1994 HSC Code has been amended most recently by Resolution MSC.259(84).

²⁾ The 2000 HSC Code has been amended most recently by MSC.271(85).

4. “Craft constructed” means a craft the keel of which is laid or which is at a similar stage of construction.
5. “Similar stage of construction” means a stage at which:
 - 5.1. construction identifiable with a specific craft begins; and
 - 5.2. assembly of that craft has commenced comprising at least 50 tonnes or 3% of the estimated mass of all structural material, whichever is the less.

Regulation 2 – Application

1. This chapter applies to high-speed craft constructed on or after 1 January 1996, as follows:
 - 1.1. passenger craft which do not proceed in the course of their voyage more than 4 h at operational speed from a place of refuge when fully laden; and
 - 1.2. cargo craft of 500 gross tonnage and upwards which do not proceed in the course of their voyage more than 8 h at operational speed from a place of refuge when fully laden.
 - 1.3. *Cargo craft with a gross tonnage below 500 the keels of which are laid on or after 1 January 2002 and which do not proceed on their voyage for more than 8 hours at operational speed from a place of refuge when fully laden.*
2. Any craft, irrespective of the date of construction, which undergoes repairs, alterations, modifications and outfitting related thereto shall continue to comply with at least the requirements previously applicable to the craft. Such a craft, if constructed before 1 July 2002, shall, as a rule, comply with the requirements for a craft constructed on or after that date to at least the same extent as it did before undergoing such repairs, alterations, modifications or outfitting. Repairs, alterations and modifications of a major character, and outfitting related thereto, shall meet the requirements for a craft constructed on or after 1 July 2002 in so far as the Administration deems reasonable and practicable.

Regulation 3 – Requirements for high-speed craft³⁾, ⁴⁾

1. Notwithstanding the provisions of chapters I to IV and regulations V/18, 19 and 20:
 - 1.1. a high-speed craft constructed on or after 1 January 1996 but before 1 July 2002 which complies with the requirements of the High-Speed Craft Code, 1994 in its entirety and which has been surveyed and certified as provided in that Code shall be deemed to have complied with the requirements of chapters I to IV and regulations V/18, 19 and 20. For the purpose of this regulation, the requirements of that Code shall be treated as mandatory;
 - 1.2. a high-speed craft constructed on or after 1 July 2002 which complies with the requirements of the High-Speed Craft Code, 2000 in its entirety and which has been surveyed and certified as provided in that Code shall be deemed to have complied with the requirements of chapters I to IV and regulations V/18, 19 and 20.
2. The certificates and permits issued under the High-Speed Craft Code shall have the same force and the same recognition as the certificates issued under chapter I.

³⁾ Reference is made to MSC/Circ.911 as well as MSC/Circ.911/Add.1 which contain interpretations of the provisions on fire safety contained in the International Code of Safety for High-Speed Craft (HSC Code). The interpretations shall be used as guidelines in connection with compliance with the relevant requirements of the HSC Code for constructive fire safety as well as installations, arrangements and equipment installed on board high-speed craft after 21 May 1999.

⁴⁾ Reference is also made to MSC/Circ.1001, Interim Guidelines for a simplified evacuation analysis of high-speed passenger craft.

3. *For passenger high-speed craft, a permit to carry passengers as stipulated in regulation I/12 shall be issued as well.*

For cargo high-speed craft, a sailing permit as stipulated in regulation II/2 shall be issued as well.

A permit to carry passengers and the sailing permit for cargo vessels shall follow what has been stipulated in regulation I/14 as to validity and duration.

**Notice from the Danish Maritime Authority B –
The Construction and Equipment, etc. of Ships**

Chapter B XI

Special measures to enhance maritime safety

Regulation 1 – Authorization of recognized organizations	1
Regulation 2 – Enhanced surveys	1
Regulation 3 – Ship identification number	2
Regulation 3-1 company and registered owner identification number	2
Regulation 4 – Port State control on operational requirements	3
Regulation 5 – Continuous Synopsis Record.....	3

Part A – General

Regulation 1 – Authorization of recognized organizations

Organizations referred to in regulation I/6 shall comply with the guidelines adopted by the Organization by resolution A.739(18), as may be amended by the Organization, and the specifications adopted by the Assembly of the Organization by resolution A.789(19), as may be amended by the Organization, provided that such amendments are adopted, brought into force and take effect in accordance with the provisions of article VIII of the SOLAS Convention concerning the amendment procedures applicable to the annex other than chapter I.

Regulation 2 – Enhanced surveys¹⁾

This regulation shall not apply to ships with a gross tonnage below 500.

Bulk carriers as defined in regulation IX/1.6 and oil tankers as defined in regulation II-1/2.22 shall be subject to an enhanced programme of inspections in accordance with the guidelines adopted by the Assembly of the Organization by resolution A.744(18)²⁾, as may be amended by the Organization, provided that such amendments are adopted, brought into force and take effect in accordance with the provisions of article VIII of the SOLAS Convention concerning the amendment procedures applicable to the annex other than chapter I.

¹⁾ Refer to MSC/Circ.655 on guidance for planning the enhanced programme of inspections surveys of bulk carriers and oil tankers and MSC/Circ.686, Guidelines on the means of access to structures for inspection and maintenance of oil tankers and bulk carriers.

²⁾ As amended by resolutions MSC. 49(66), MSC.105(73), MSC.108(73), MSC.125(75), MSC. 144(77) and MSC. 197(80).

Regulation 3 – Ship identification number

(Paragraphs 4 and 5 apply to all ships to which this regulation applies. For ships constructed before 1 July 2004, the requirements of paragraphs 4 and 5 shall be complied with not later than the first scheduled dry docking of the ship after 1 July 2004).

1. This regulation applies to all passenger ships of 100 gross tonnage and upwards and to all cargo ships of 300 gross tonnage and upwards.
2. Every ship shall be provided with an identification number which conforms to the IMO ship identification number scheme adopted by the Organization.³⁾
3. The ship's identification number shall be inserted on the certificates and certified copies thereof issued under regulation I/12 or regulation I/13.
4. The ship's identification number shall be permanently marked:
 - 4.1. in a visible place either on the stern of the ship or on either side of the hull, amidships port and starboard, above the deepest assigned load line or either side of the superstructure, port and starboard or on the front of the superstructure or, in the case of passenger ships, on a horizontal surface visible from the air; and
 - 4.2. in an easily accessible place either on one of the end transverse bulkheads of the machinery spaces, as defined in regulation II-2/3.30, or on one of the hatchways or, in the case of tankers, in the pump-room or, in the case of ships with ro-ro spaces, as defined in regulation II-2/3.41, on one of the end transverse bulkheads of the ro-ro spaces.
5.
 - 5.1. The permanent marking shall be plainly visible, clear of any other markings on the hull and shall be painted in a contrasting colour.
 - 5.2. The permanent marking referred to in paragraph 4.1 shall be not less than 200 mm in height. The permanent marking referred to in paragraph 4.2 shall not be less than 100 mm in height. The width of the marks shall be proportionate to the height.
 - 5.3. The permanent marking may be made by raised lettering or by cutting it in or by centre-punching it or by any other equivalent method of marking the ship identification number which ensures that the marking is not easily expunged.
 - 5.4. On ships constructed of material other than steel or metal, the Administration shall approve the method of marking the ship identification number.

Regulation 3-1 – Company and registered owner identification number

1. This regulation applies to all companies and registered owners of passenger ships to which chapter I applies, and all cargo ships of 300 gross tonnage and upwards.
2. When applying this regulation, the registered owner is to be interpreted as given by the Administration and the company as defined in regulation IX/1.
3. Every company and registered owner shall be provided with an identification number which conforms to the IMO Unique Company and Registered Owner Identification Number Scheme adopted by the Organization.⁴⁾

³⁾ Refer to the IMO Ship Identification Number Scheme adopted by the Organisation by resolution A.600(15).

⁴⁾ Refer to resolution MSC.160(78) Adoption of the IMO Unique Company and Registered Owner Identification Number Scheme.

4. The company and registered owner identification shall be inserted on the certificates and certified copies thereof issued under regulation IX/4 and part A/19.2 or A/19.4 of the ISPS code.
5. This regulation shall enter into force when the certificates referred to in paragraph 4 are issued or renewed on or after 1 January 2009.

Regulation 4 – Port State control on operational requirements⁵

1. A ship when in a port of another Contracting Government is subject to control by officers duly authorized by such Government concerning operational requirements in respect of the safety of ships, when there are clear grounds for believing that the master or crew are not familiar with essential shipboard procedures relating to the safety of ships.
2. In the circumstances defined in paragraph 1 of this regulation, the Contracting Government carrying out the control shall take such steps as will ensure that the ship shall not sail until the situation has been brought to order in accordance with the requirements of the present Convention.
3. Procedures relating to the port State control prescribed in regulation I/19 shall apply to this regulation.
4. Nothing in the present regulation shall be construed to limit the rights and obligations of a Contracting Government carrying out control over operational requirements specifically provided for in the regulations.

Regulation 5 – Continuous Synopsis Record

1. Every ship to which chapter I applies shall be issued with a Continuous Synopsis Record. *However, this shall not apply to cargo ships with a gross tonnage below 500 and ships that are not engaged in international voyages.*
2.
 - 1.1. The Continuous Synopsis Record is intended to provide an on-board record of the history of the ship with respect to the information recorded therein.
 - 1.2. For ships constructed before 1 July 2004, the Continuous Synopsis Record shall, at least, provide the history of the ship as from 1 July 2004.
3. The Continuous Synopsis Record shall be issued by the Administration to each ship that is entitled to fly its flag and it shall contain, at least, the following information (the Continuous Synopsis Record shall contain the information stipulated in paragraphs 3.7 and 3.10 if issued or updated on or after 1 January 2009):
 - 1.1. the name of the State whose flag the ship is entitled to fly;
 - 1.2. the date on which the ship was registered with that State;
 - 1.3. the ship's identification number in accordance with regulation 3;
 - 1.4. the name of the ships;
 - 1.5. the port at which the ship is registered;
 - 1.6. the name of the registered owner(s) and their registered address(es);
 - 1.7. registered owner identification number;
 - 1.8. the name of the registered bareboat charterer(s) and their registered address(es), if applicable;

⁵⁾ Refer to the Procedures for port state control adopted by the Organization by resolution A.787(19), as amended by resolution A.882(21).

- 1.9. the name of the Company, as defined in regulation IX/1, its registered address and the address(es) from where it carries out the safety-management activities;
 - 1.10. Company identification number;
 - 1.11. the name of all classification society (ies) with which the ship is classed;
 - 1.12. the name of the Administration or of the Contracting Government or of the recognized organization which has issued the Document of Compliance (or the Interim Document of Compliance), specified in the ISM Code as defined in regulation IX/1, to the Company operating the ship and the name of the body which has carried out the audit on the basis of which the Document was issued, if other than that issuing the Document;
 - 1.13. the name of the Administration or of the Contracting Government or of the recognized organization that has issued the Safety Management Certificate (or the Interim Safety Management Certificate), specified in the ISM Code as defined in regulation IX/1, to the ship and the name of the body which has carried out the audit on the basis of which the Certificate was issued, if other than that issuing the Certificate;
 - 1.14. the name of the Administration or of the Contracting Government or of the recognized security organization that has issued the International Ship Security Certificate (or the Interim International Ship Security Certificate), specified in part A of the ISPS Code as defined in regulation XI-2/1, to the ship and the name of the body which has carried out the verification on the basis of which the Certificate was issued, if other than that issuing the Certificate; and
 - 1.15. the date on which the ship ceased to be registered with that State.
4.
 - 1.1. Any changes relating to the entries referred to in paragraphs 3.4 to 3.12 shall be recorded in the Continuous Synopsis Record so as to provide updated and current information together with the history of the changes.
 - 1.2. In case of any changes relating to the entries referred to in paragraph 4.1, the Administration shall issue, as soon as is practically possible but not later than three months from the date of the change, to the ships entitled to fly its flag either a revised and updated version of the Continuous Synopsis Record or appropriate amendments thereto.
 - 1.3. In case of any changes relating to the entries referred to in paragraph 4.1, the Administration, pending the issue of a revised and updated version of the Continuous Synopsis Record, shall authorize and require either the Company as defined in regulation IX/1 or the master of the ship to amend the Continuous Synopsis Record to reflect the changes. In such cases, after the Continuous Synopsis Record has been amended, the Company shall, without delay, inform the Administration accordingly.
 5.
 - 1.1. The Continuous Synopsis Record shall be in English, French or Spanish language. Additionally, a translation of the Continuous Synopsis Record into the official language or languages of the Administration may be provided.
 - 1.2. The Continuous Synopsis Record shall be in the format developed by the Organization and shall be maintained in accordance with guidelines developed by the Organization.⁶⁾

⁶⁾ Refer to Format and Guidelines for the Maintenance of the Continuous Synopsis Record as adopted by Resolution A.959(23), as amended by Resolution MSC.198(80), and to MSC/Circ.1113 on "Guidance to port State officers on the non-security related elements of the 2002 SOLAS amendments".

Any previous entries in the Continuous Synopsis Record shall not be modified, deleted or, in any way, erased or defaced.

6. Whenever a ship is transferred to the flag of another State or the ship is sold to another owner (or is taken over by another bareboat charterer) or another Company assumes the responsibility for the operation of the ships, the Continuous Synopsis Record shall be left on board.
7. When a ship is to be transferred to the flag of another State, the Company shall notify the Administration of the name of the State under whose flag the ship is to be transferred so as to enable the Administration to forward to that State a copy of the Continuous Synopsis Record covering the period during which the ship was under its jurisdiction.
8. When a ship is transferred to the flag of another State the Government of which is a Contracting Government, the Contracting Government of the State whose flag the ship was flying hitherto shall transmit to the Administration, as soon as possible after the transfer takes place, a copy of the relevant Continuous Synopsis Record covering the period during which the ship was under their jurisdiction together with any Continuous Synopsis Records previously issued to the ship by other States.
9. When a ship is transferred to the flag of another State, the Administration shall append the previous Continuous Synopsis Records to the Continuous Synopsis Record the Administration will issue to the ship so to provide the continuous history record intended by this regulation.
10. The Continuous Synopsis Record shall be kept on board the ship and shall be available for inspection at all times.

Regulation 6 – Additional requirements for the investigation of marine casualties and incidents

1. Taking into account regulation I/21, each Administration shall conduct investigations of marine casualties and incidents, in accordance with the provisions of the present Convention, as supplemented by the provisions of the Code of the International Standards and Recommended Practices for a Safety Investigation into a Marine Casualty or Marine Incident (Casualty Investigation Code) adopted by resolution MSC.255(84), and:
 - 1.1. the provisions of parts I and II of the Casualty Investigation Code shall be fully complied with;
 - 1.2. the related guidance and explanatory material contained in part III of the Casualty Investigation Code should be taken into account to the greatest possible extent in order to achieve a more uniform implementation of the Casualty Investigation Code;
 - 1.3. amendments to parts I and II of the Casualty Investigation Code shall be adopted, brought into force and take effect in accordance with the provisions of article VIII of the present Convention concerning the amendment procedures applicable to the annex other than chapter I; and
 - 1.4. part III of the Casualty Investigation Code shall be amended by the Maritime Safety Committee in accordance with its rules of procedure.

**Notice from the Danish Maritime Authority B –
The Construction and Equipment, etc. of Ships
Chapter B XI-2
Special measures to enhance maritime security**

Regulation 1 –Definitions	2
Regulation 2 – Application	3
Regulation 3 – Obligations of Contracting Governments with respect to security	3
Regulation 4 – Requirements for Companies and ships	4
Regulation 5 – Specific responsibility of Companies	4
Regulation 6 – Ship security alert system.....	4
Regulation 7 – Threats to ships.....	5
Regulation 8 – Master’s discretion for ship safety and security	5
Regulation 9 – Control and compliance measures.....	6
Regulation 10 – Requirements for port facilities	8
Regulation 11 – Alternative security agreements	8
Regulation 12 – Equivalent security arrangements.....	8
Regulation 13 – Communication of information	9

Introduction

Special measures to enhance maritime security is regulated by Regulation (EC) No 725/2004 of the European Parliament and of the Council of 31 March 2004 on enhancing ship and port facility security. Chapter XI-2 has been included for the sake of completeness since Notice B from the Danish Maritime Authority is also a Danish translation of the International Convention for the Safety of Life at Sea.

Implementation, administration and enforcement of the regulations in chapter XI-2 is managed by several public authorities: The Ministry of Defence, hereunder the Admiral Danish Fleet; the Ministry of Justice, hereunder the police; the Ministry of Transport, hereunder the Coastal Directorate; and the Ministry of Economic and Business Affairs, hereunder the Danish Maritime Authority.

The practical implementation, administration and enforcement of the regulations is managed so that the responsibilities are handled by the authority which with consideration for the existing organisational structure, distribution of responsibility and use of resources within the maritime and security area can handle the responsibility in the most expedient manner.

Apart from being an implementation of the International Convention for the Safety of Life at Sea (the SOLAS Convention), Notice B from the Danish Maritime Authority also serves the purpose of being a

translation of the SOLAS Convention into Danish and chapter XI-2 has been reproduced in its entirety even though some provisions are implemented by other authorities.

Regulation 1 –Definitions

1. For the purpose of this chapter, unless expressly provided otherwise:
 - 1.1. “Bulk carrier” means a bulk carrier as defined in regulation IX/1.6.
 - 1.2. “Chemical tanker” means a chemical tanker as defined in regulation VII/8.2.
 - 1.3. “Gas carrier” means a gas carrier as defined in regulation VII/11.2.
 - 1.4. “High-speed craft” means a craft as defined in regulation X/1.2.
 - 1.5. “Mobile offshore drilling unit” means a mechanically propelled mobile offshore drilling unit, as defined in regulation IX/1, not on location.
 - 1.6. “Oil tanker” means an oil tanker as defined in regulation II-1/2.22.
 - 1.7. “Company” means a Company as defined in regulation IX/1.
 - 1.8. “Ship/port interface” means the interactions that occur when a ship is directly and immediately affected by actions involving the movement of persons, goods or the provisions of port services to or from the ship.
 - 1.9. “Port facility” is a location, as determined by the Contracting Government or by the Designated Authority, where the ship/port interface takes place. This includes areas such as anchorages, waiting berths and approaches from seaward, as appropriate.
 - 1.10. “Ship to ship activity” means any activity not related to a port facility that involves the transfer of goods or persons from one ship to another.
 - 1.11. “Designated Authority” means the organization(s) or the administration(s) identified, within the Contracting Government, as responsible for ensuring the implementation of the provisions of this chapter pertaining to port facility security and ship/port interface, from the point of view of the port facility.
 - 1.12. “International Ship and Port Facility Security (ISPS) Code” means the International Code for the Security of Ships and of Port Facilities consisting of Part A (the provisions of which shall be treated as mandatory) and part B (the provisions of which shall be treated as recommendatory), as adopted, on 12 December 2002, by resolution 2 of the Conference of Contracting Governments to the International Convention for the Safety of Life at Sea, 1974 as may be amended by the Organization¹, provided that:
 - 1.12.1. amendments to part A of the Code are adopted, brought into force and take effect in accordance with article VIII of the present Convention concerning the amendment procedures applicable to annexes of the SOLAS Convention other than chapter I; and
 - 1.12.2. amendments to part B of the Code are adopted by the Maritime Safety Committee in accordance with its Rules of Procedure.
 - 1.13. “Security incident” means any suspicious act or circumstance threatening the security of a ship, including a mobile offshore drilling unit and a high speed craft, or of a port facility or of any ship/port interface or any ship to ship activity.
 - 1.14. “Security level” means the qualification of the degree of risk that a security incident will be attempted or will occur.

¹ As amended most recently by resolution MSC.196(80).

- 1.15. “Declaration of security” means an agreement reached between a ship and either a port facility or another ship with which it interfaces specifying the security measures each will implement.
- 1.16. “Recognized security organization” means an organization with appropriate expertise in security matters and with appropriate knowledge of ship and port operations authorized to carry out an assessment, or a verification, or an approval or a certification activity, required by this chapter or by part A of the ISPS Code.
- 2. The term “ship”, when used in regulations 3 to 13, includes mobile offshore drilling units and high-speed craft.
- 3. The term “all ships”, when used in this chapter, means any ship to which this chapter applies.
- 4. The term “Contracting Government”, when used in regulations 3, 4, 7, and 10 to 13 includes a reference to the “Designated Authority”.

Regulation 2 – Application

- 1. This chapter applies to:
 - 1.1. the following types of ships engaged on international voyages:
 - 1.1.1. passenger ships, including high speed passenger craft;
 - 1.1.2. cargo ships, including high-speed craft, of 500 gross tonnage and upwards; and
 - 1.1.3. mobile offshore drilling units; and
 - 1.2. port facilities serving such ships engaged on international voyages.
- 2. Notwithstanding the provisions of paragraph 1.2, Contracting Governments shall decide the extent of application of this chapter and of the relevant sections of part A of the ISPS Code to those port facilities within their territory which, although used primarily by ships not engaged on international voyages, are required, occasionally, to serve ships arriving or departing on an international voyage.
 - 2.1. Contracting Governments shall base their decisions, under paragraph 2, on a port facility security assessment carried out in accordance with the provisions of part A of the ISPS Code.
 - 2.2. Any decision which a Contracting Government makes, under paragraph 2, shall not compromise the level of security intended to be achieved by this chapter or by part A of the ISPS Code.
- 3. This chapter does not apply to warships, naval auxiliaries or other ships owned or operated by a Contracting Government and used only on Government non-commercial service.
- 4. Nothing in this chapter shall prejudice the rights or obligations of States under international law.

Regulation 3 – Obligations of Contracting Governments with respect to security

- 1. Administrations shall set security levels and ensure the provision of security level information to ships entitled to fly their flag. When changes in security level occur, security level information shall be updated as the circumstance dictates.
- 2. Contracting Governments shall set security levels and ensure the provision of security level information to port facilities within their territory, and to ships prior to entering a port or whilst in a port within their territory. When changes in security level occur, security level information shall be updated as the circumstance dictates.

Regulation 4 – Requirements for Companies and ships

1. Companies shall comply with the relevant requirements of this chapter and of part A of the ISPS Code, taking into account the guidance given in part B of the ISPS Code.
2. Ships shall comply with the relevant requirements of this chapter and of part A of the ISPS Code, taking into account the guidance given in part B of the ISPS Code, and such compliance shall be verified and certified as provided for in part A of the ISPS Code.
3. Prior to entering a port or whilst in a port within the territory of a Contracting Government, a ship shall comply with the requirements for the security level set by that Contracting Government, if such security level is higher than the security level set by the Administration for that ship.
4. Ships shall respond without undue delay to any change to a higher security level.
5. Where a ship is not in compliance with the requirements of this chapter or of part A of the ISPS Code, or cannot comply with the requirements of the security level set by the Administration or by another Contracting Government and applicable to that ship, then the ship shall notify the appropriate competent authority prior to conducting any ship/port interface or prior to entry into port, whichever occurs earlier.

Regulation 5 – Specific responsibility of Companies

The Company shall ensure that the master has available on board, at all times, information through which officers duly authorized by a Contracting Government can establish:

1. who is responsible for appointing the members of the crew or other persons currently employed or engaged on board the ship in any capacity on the business of that ship;
2. who is responsible for deciding the employment of the ship; and
3. in cases where the ship is employed under the terms of charter party(ies), who are the parties to such charter party(ies).

Regulation 6 – Ship security alert system²

1. All ships shall be provided with a ship security alert system, as follows:
 - 1.1. ships constructed on or after 1 July 2004;
 - 1.2. passenger ships, including high-speed passenger craft, constructed before 1 July 2004, not later than the first survey of the radio installation after 1 July 2004;
 - 1.3. oil tankers, chemical tankers, gas carriers, bulk carriers and cargo high speed craft, of 500 gross tonnage and upwards constructed before 1 July 2004, not later than the first survey of the radio installation after 1 July 2004; and
 - 1.4. other cargo ships of 500 gross tonnage and upward and mobile offshore drilling units constructed before 1 July 2004, not later than the first survey of the radio installation after 1 July 2006.
2. The ship security alert system, when activated, shall:
 - 2.1. initiate and transmit a ship-to-shore security alert to a competent authority designated by the Administration, which in these circumstances may include the Company, identifying the ship, its location and indicating that the security of the ship is under threat or it has been compromised;
 - 2.2. not send the ship security alert to any other ships;

² Refer to the Performance Standards for a ship security alert system adopted by resolution MSC.136(76) and to Revised performance standards for ship security alert systems adopted by resolution MSC.147(77).

- 2.3. not raise any alarm on-board the ship; and
- 2.4. continue the ship security alert until deactivated and/or reset.
- 3. The ship security alert system shall:
 - 3.1. be capable of being activated from the navigation bridge and in at least one other location; and
 - 3.2. conform to performance standards not inferior to those adopted by the Organization.
- 4. The ship security alert system activation points shall be designed so as to prevent the inadvertent initiation of the ship security alert.
- 5. The requirement for a ship security alert system may be complied with by using the radio installation fitted for compliance with the requirements of chapter IV, provided all requirements of this regulation are complied with.
- 6. When an Administration receives notification of a ship security alert, that Administration shall immediately notify the State(s) in the vicinity of which the ship is presently operating.
- 7. When a Contracting Government receives notification of a ship security alert from a ship which is not entitled to fly its flag, that Contracting Government shall immediately notify the relevant Administration and, if appropriate, the State(s) in the vicinity of which the ship is presently operating.

Regulation 7 – Threats to ships

- 1. Contracting Governments shall set security levels and ensure the provision of security level information to ships operating in their territorial sea or having communicated an intention to enter their territorial sea.
- 2. Contracting Governments shall provide a point of contact through which such ships can request advice or assistance and to which such ships can report any security concerns about other ships, movements or communications.
- 3. Where a risk of attack has been identified, the Contracting Government concerned shall advise the ships concerned and their Administrations of:
 - 3.1. the current security level;
 - 3.2. any security measures that should be put in place by the ships concerned to protect themselves from attack, in accordance with the provisions of part A of the ISPS Code; and
 - 3.3. security measures that the coastal State has decided to put in place, as appropriate.

Regulation 8 – Master’s discretion for ship safety and security

- 1. The master shall not be constrained by the Company, the charterer or any other person from taking or executing any decision which, in the professional judgement of the master, is necessary to maintain the safety and security of the ship. This includes denial of access to persons (except those identified as duly authorized by a Contracting Government) or their effects and refusal to load cargo, including containers or other closed cargo transport units.
- 2. If, in the professional judgement of the master, a conflict between any safety and security requirements applicable to the ship arises during its operations, the master shall give effect to those requirements necessary to maintain the safety of the ship. In such cases, the master may implement temporary security measures and shall forthwith inform the Administration and, if appropriate, the Contracting Government in whose port the ship is operating or intends to enter. Any such temporary security measures under this regulation shall, to the highest possible degree, be

commensurate with the prevailing security level. When such cases are identified, the Administration shall ensure that such conflicts are resolved and that the possibility of recurrence is minimized.

Regulation 9 – Control and compliance measures

1. Control of ships in port

- 1.1. For the purpose of this chapter, every ship to which this chapter applies is subject to control when in a port of another Contracting Government by officers duly authorized by that Government, who may be the same as those carrying out the functions of regulation I/19. Such control shall be limited to verifying that there is onboard a valid International Ship Security Certificate or a valid Interim International Ship Security Certificate issued under the provisions of part A of the ISPS Code (Certificate), which if valid shall be accepted, unless there are clear grounds for believing that the ship is not in compliance with the requirements of this chapter or part A of the ISPS Code.
- 1.2. When there are such clear grounds, or where no valid Certificate is produced when required, the officers duly authorized by the Contracting Government shall impose any one or more control measures in relation to that ship as provided in paragraph 1.3. Any such measures imposed must be proportionate, taking into account the guidance given in part B of the ISPS Code.
- 1.3. Such control measures are as follows: inspection of the ship, delaying the ship, detention of the ship, restriction of operations including movement within the port, or expulsion of the ship from port. Such control measures may additionally or alternatively include other lesser administrative or corrective measures.

2. Ships intending to enter a port of another Contracting Government

- 2.1. For the purpose of this chapter, a Contracting Government may require that ships intending to enter its ports provide the following information to officers duly authorized by that Government to ensure compliance with this chapter prior to entry into port with the aim of avoiding the need to impose control measures or steps:
 - 2.1.1. that the ship possesses a valid Certificate and the name of its issuing authority;
 - 2.1.2. the security level at which the ship is currently operating;
 - 2.1.3. the security level at which the ship operated in any previous port where it has conducted a ship/port interface within the timeframe specified in paragraph 2.3;
 - 2.1.4. any special or additional security measures that were taken by the ship in any previous port where it has conducted a ship/port interface within the timeframe specified in paragraph 2.3;
 - 2.1.5. that the appropriate ship security procedures were maintained during any ship to ship activity within the timeframe specified in paragraph 2.3; or
 - 2.1.6. other practical security related information (but not details of the ship security plan), taking into account the guidance given in part B of the ISPS Code.

If requested by the Contracting Government, the ship or the Company shall provide confirmation, acceptable to that Contracting Government, of the information required above.
- 2.2. Every ship to which this chapter applies intending to enter the port of another Contracting Government shall provide the information described in paragraph 2.1 on the request of the

officers duly authorized by that Government. The master may decline to provide such information on the understanding that failure to do so may result in denial of entry into port.

- 2.3. The ship shall keep records of the information referred to in paragraph 2.1 for the last 10 calls at port facilities.
- 2.4. If, after receipt of the information described in paragraph 2.1, officers duly authorized by the Contracting Government of the port in which the ship intends to enter have clear grounds for believing that the ship is in non-compliance with the requirements of this chapter or part A of the ISPS Code, such officers shall attempt to establish communication with and between the ship and the Administration in order to rectify the non-compliance. If such communication does not result in rectification, or if such officers have clear grounds otherwise for believing that the ship is in non-compliance with the requirements of this chapter or part A of the ISPS Code, such officers may take steps in relation to that ship as provided in paragraph 2.5. Any such steps taken must be proportionate, taking into account the guidance given in part B of the ISPS Code.
- 2.5. Such steps are as follows:
 - 2.5.1. a requirement for the rectification of the non-compliance;
 - 2.5.2. a requirement that the ship proceed to a location specified in the territorial sea or internal waters of that Contracting Government;
 - 2.5.3. inspection of the ship, if the ship is in the territorial sea of the Contracting Government the port of which the ship intends to enter; or
 - 2.5.4. denial of entry into port.

Prior to initiating any such steps, the ship shall be informed by the Contracting Government of its intentions. Upon this information the master may withdraw the intention to enter that port. In such cases, this regulation shall not apply.

3. Additional provisions

- 3.1. In the event:
 - 3.1.1. of the imposition of a control measure, other than a lesser administrative or corrective measure, referred to in paragraph 1.3; or
 - 3.1.2. any of the steps referred to in paragraph 2.5 are taken, an officer duly authorized by the Contracting Government shall forthwith inform in writing the Administration specifying which control measures have been imposed or steps taken and the reasons thereof. The Contracting Government imposing the control measures or steps shall also notify the recognized security organization, which issued the Certificate relating to the ship concerned and the Organization when any such control measures have been imposed or steps taken.
- 3.2. When entry into port is denied or the ship is expelled from port, the authorities of the port State should communicate the appropriate facts to the authorities of the State of the next appropriate ports of call, when known, and any other appropriate coastal States, taking into account guidelines to be developed by the Organization. Confidentiality and security of such notification shall be ensured.
- 3.3. Denial of entry into port, pursuant to paragraphs 2.4 and 2.5, or expulsion from port, pursuant to paragraphs 1.1 to 1.3, shall only be imposed where the officers duly authorized by the Contracting Government have clear grounds to believe that the ship poses an immediate threat to the security or safety of persons, or of ships or other property and there are no other appropriate means for removing that threat.

- 3.4. The control measures referred to in paragraph 1.3 and the steps referred to in paragraph 2.5 shall only be imposed, pursuant to this regulation, until the non-compliance giving rise to the control measures or steps has been corrected to the satisfaction of the Contracting Government, taking into account actions proposed by the ship or the Administration, if any.
- 3.5. When Contracting Governments exercise control under paragraph 1 or take steps under paragraph 2:
 - 3.5.1. all possible efforts shall be made to avoid a ship being unduly detained or delayed. If a ship is thereby unduly detained, or delayed, it shall be entitled to compensation for any loss or damage suffered; and
 - 3.5.2. necessary access to the ship shall not be prevented for emergency or humanitarian reasons and for security purposes.

Regulation 10 – Requirements for port facilities

1. Port facilities shall comply with the relevant requirements of this chapter and part A of the ISPS Code, taking into account the guidance given in part B of the ISPS Code.
2. Contracting Governments with a port facility or port facilities within their territory, to which this regulation applies, shall ensure that:
 - 2.1. port facility security assessments are carried out, reviewed and approved in accordance with the provisions of part A of the ISPS Code;
 - 2.2. port facility security plans are developed, reviewed, approved and implemented in accordance with the provisions of part A of the ISPS Code
3. Contracting Governments shall designate and communicate the measures required to be addressed in a port facility security plan for the various security levels, including when the submission of a Declaration of Security will be required.

Regulation 11 – Alternative security agreements

1. Contracting Governments may, when implementing this chapter and part A of the ISPS Code, conclude in writing bilateral or multilateral agreements with other Contracting Governments on alternative security arrangements covering short international voyages on fixed routes between port facilities located within their territories.
2. Any such agreement shall not compromise the level of security of other ships or of port facilities not covered by the agreement.
3. No ship covered by such an agreement shall conduct any ship-to-ship activities with any ship not covered by the agreement.
4. Such agreements shall be reviewed periodically, taking into account the experience gained as well as any changes in the particular circumstances or the assessed threats to the security of the ships, the port facilities or the routes covered by the agreement.

Regulation 12 – Equivalent security arrangements

1. An Administration may allow a particular ship or a group of ships entitled to fly its flag to implement other security measures equivalent to those prescribed in this chapter or in part A of the ISPS Code, provided such security measures are at least as effective as those prescribed in this chapter or part A of the ISPS Code. The Administration, which allows such security measures, shall communicate to the Organization particulars thereof.

2. When implementing this chapter and part A of the ISPS Code, a Contracting Government may allow a particular port facility or a group of port facilities located within its territory, other than those covered by an agreement concluded under regulation 11, to implement security measures equivalent to those prescribed in this chapter or in Part A of the ISPS Code, provided such security measures are at least as effective as those prescribed in this chapter or part A of the ISPS Code. The Contracting Government, which allows such security measures, shall communicate to the Organization particulars thereof.

Regulation 13 – Communication of information

1. Contracting Governments shall, not later than 1 July 2004, communicate to the Organization and shall make available for the information of Companies and ships:
 - 1.1. the names and contact details of their national authority or authorities responsible for ship and port facility security;
 - 1.2. the locations within their territory covered by the approved port facility security plans.
 - 1.3. the names and contact details of those who have been designated to be available at all times to receive and act upon the ship-to-shore security alerts, referred to in regulation 6.2.1;
 - 1.4. the names and contact details of those who have been designated to be available at all times to receive and act upon any communications from Contracting Governments exercising control and compliance measures, referred to in regulation 9.3.1; and
 - 1.5. the names and contact details of those who have been designated to be available at all times to provide advice or assistance to ships and to whom ships can report any security concerns, referred to in regulation 7.2;
and thereafter update such information as and when changes relating thereto occur. The Organization shall circulate such particulars to other Contracting Governments for the information of their officers.
2. Contracting Governments shall, not later than 1 July 2004, communicate to the Organization the names and contact details of any recognized security organizations authorized to act on their behalf together with details of the specific responsibility and conditions of authority delegated to such organizations. Such information shall be updated as and when changes relating thereto occur. The Organization shall circulate such particulars to other Contracting Governments for the information of their officers.
3. Contracting Governments shall, not later than 1 July 2004 communicate to the Organization a list showing the approved port facility security plans for the port facilities located within their territory together with the location or locations covered by each approved port facility security plan and the corresponding date of approval and thereafter shall further communicate when any of the following changes take place:
 - 3.1. changes in the location or locations covered by an approved port facility security plan are to be introduced or have been introduced. In such cases the information to be communicated shall indicate the changes in the location or locations covered by the plan and the date as of which such changes are to be introduced or were implemented;
 - 3.2. an approved port facility security plan, previously included in the list submitted to the Organization, is to be withdrawn or has been withdrawn. In such cases, the information to be communicated shall indicate the date on which the withdrawal will take effect or was

implemented. In these cases, the communication shall be made to the Organization as soon as is practically possible; and

- 3.3. additions are to be made to the list of approved port facility security plans. In such cases, the information to be communicated shall indicate the location or locations covered by the plan and the date of approval.
4. Contracting Governments shall, at five year intervals after 1 July 2004, communicate to the Organization a revised and updated list showing all the approved port facility security plans for the port facilities located within their territory together with the location or locations covered by each approved port facility security plan and the corresponding date of approval (and the date of approval of any amendments thereto) which will supersede and replace all information communicated to the Organization, pursuant to paragraph 3, during the preceding five years.
5. Contracting Governments shall communicate to the Organization information that an agreement under regulation 11 has been concluded. The information communicated shall include:
 - 5.1. the names of the Contracting Governments which have concluded the agreement;
 - 5.2. the port facilities and the fixed routes covered by the agreement;
 - 5.3. the periodicity of review of the agreement;
 - 5.4. the date of entry into force of the agreement; and
 - 5.5. information on any consultations which have taken place with other Contracting Governments; and thereafter shall communicate, as soon as practically possible, to the Organization information when the agreement has been amended or has ended.
6. Any Contracting Government which allows, under the provisions of regulation 12, any equivalent security arrangements with respect to a ship entitled to fly its flag or with respect to a port facility located within its territory, shall communicate to the Organization particulars thereof.
7. The Organization shall make available the information communicated under paragraph 3 to other Contracting Governments upon request.

Notice from the Danish Maritime Authority B –The Construction and Equipment, etc. of Ships

Chapter B XII Additional safety measures for bulk carriers of 1 April 2008

Regulation 1 – Definitions	1
Regulation 2 – Application	2
Regulation 3 – Implementation schedule	2
Regulation 4 – Damage stability requirements applicable to bulk carriers	3
Regulation 5 – Structural strength of bulk carriers	3
Regulation 6 – Structural and other requirements for bulk carriers.....	4
Regulation 7 – Survey of the cargo hold structure of bulk carriers	5
Regulation 8- Information on compliance with requirements for bulk carriers	5
Regulation 9 – Requirements for bulk carriers not being capable of complying with regulation 4.2 due to the design configuration of their cargo holds.....	5
Regulation 10 – Solid bulk cargo density declaration	6
Regulation 11 – Loading instrument.....	6
Regulation 12 – Hold, ballast and dry space water level detectors.....	6
Regulation 13 – Availability of pumping systems.....	7
Regulation 14 - Restrictions from sailing with any hold empty	7

Regulation 1 – Definitions

For the purpose of this chapter:

- 1 “Bulk carrier” means a ship which is intended primarily to carry dry cargo in bulk, including such types as ore carriers and combination carriers¹⁾
- 2 “Bulk carrier of single side skin construction” means a bulk carrier as defined in paragraph 1, in which:
 - 2.1 any part of a cargo hold is bounded by the side shell; or
 - 2.2 where one or more cargo holds are bounded by a double-side skin, the width of which is less than 760 mm in bulk carriers constructed before 1 January 2000 and less than 1,000 mm in bulk carriers constructed on or after 1 January 2000 but before 1 July 2006, the distance being measured perpendicular to the side shell.

¹⁾ Reference is made to:

For ships constructed before 1 July 2006, resolution 6, Interpretation of the definition of bulk carrier., as given in chapter IX of SOLAS 1974, as amended in 1994, adopted by the 1997 SOLAS Conference.

The Interpretation of the provisions of SOLAS chapter XII on Additional safety measures for bulk carriers, adopted by the Maritime Safety Committee of the Organization by resolution MSC.79(70).

The application provisions of Annex 1 to the Interpretation of the provisions of SOLAS chapter XII on Additional safety measures for bulk carriers, adopted by the Maritime Safety Committee of the Organization by resolution MSC.89(71).

Such ships include combination carriers in which any part of a cargo hold is bounded by the side shell.

- 3 “Bulk carrier of double-side skin construction” means a bulk carrier as defined in paragraph 1, in which all cargo holds are bounded by a double-side skin, other than as defined in paragraph 2.2.
- 4 “Double-side skin” means a configuration where each ship side is constructed by the side shell and a longitudinal bulkhead connecting the double bottom and the deck. Hopper side tanks and top-side tanks may, where fitted, be integral parts of the doubleside skin configuration.
- 5 “Length” of a bulk carrier means the length as defined in the International Convention on Load Lines in force.
- 6 “Solid bulk cargo” means any material, other than liquid or gas, consisting of a combination of particles, granules or any larger pieces of material, generally uniform in composition, which is loaded directly into the cargo spaces of a ship without any intermediate form of containment.
- 7 “Bulk carrier bulkhead and double bottom strength standards” means .Standards for the evaluation of scantlings of the transverse watertight vertically corrugated bulkhead between the two foremost cargo holds and for the evaluation of allowable hold loading of the foremost cargo hold. adopted by resolution 4 of the Conference of Contracting Governments to the International Convention for the Safety of Life at Sea, 1974 on 27 November 1997, as may be amended by the Organization, provided that such amendments are adopted, brought into force and take effect in accordance with the provisions of article VIII of the present Convention concerning the amendment procedures applicable to the Annex other than chapter I.
- 8 “Bulk carriers constructed” means bulk carriers the keels of which are laid or which are at a similar stage of construction.
- 9 “A similar stage of construction” means the stage at which:
 - 9.1 construction identifiable with a specific ship begins; and
 - 9.2 assembly of that ship has commenced comprising at least 50 tonnes or one per cent of the estimated mass of all structural material, whichever is less.
- 10 “Breadth” (B) of a bulk carrier means the breadth as defined in the International Convention on Load Lines in force.

Regulation 2 – Application

Bulk carriers shall comply with the requirements of this chapter in addition to the applicable requirements of other chapters.

Regulation 3 – Implementation schedule

Bulk carriers constructed before 1 July 1999 to which regulations 4 or 6 apply shall comply with the provisions of such regulations according to the following schedule, with reference to the enhanced programme of inspections required by regulation XI-1/2:

1

- 1.1 bulk carriers, which are 20 years of age and over on 1 July 1999, by the date of the first intermediate survey or the first periodical survey after 1 July 1999, whichever comes first;
- 1.2 bulk carriers, which are 15 years of age and over but less than 20 years of age on 1 July 1999, by the date of the first periodical survey after 1 July 1999, but not later than 1 July 2002; and
- 1.3 bulk carriers, which are less than 15 years of age on 1 July 1999, by the date of the first periodical survey after the date on which the ship reaches 15 years of age, but not later than the date on which the ship reaches 17 years of age.

Regulation 4 – Damage stability requirements applicable to bulk carriers

- 1 Bulk carriers of 150 m in length and upwards of single-side skin construction, designed to carry solid bulk cargoes having a density of 1,000 kg/m³ and above, constructed on or after 1 July 1999 shall, when loaded to the summer load line, be able to withstand flooding of any one cargo hold in all loading conditions and remain afloat in a satisfactory condition of equilibrium, as specified in paragraph 4.
- 2 Bulk carriers of 150 m in length and upwards of double-side skin construction in which any part of longitudinal bulkhead is located within B/5 or 11.5 m, whichever is less, inboard from the ship's side at right angle to the centreline at the assigned summer load line, designed to carry solid bulk cargoes having a density of 1,000 kg/m³ and above, constructed on or after 1 July 2006 shall, when loaded to the summer load line, be able to withstand flooding of any one cargo hold in all loading conditions and remain afloat in a satisfactory condition of equilibrium, as specified in paragraph 4.
- 3 Bulk carriers of 150 m in length and upwards of single-side skin construction, carrying solid bulk cargoes having a density of 1,780 kg/m³ and above, constructed before 1 July 1999 shall, when loaded to the summer load line, be able to withstand flooding of the foremost cargo hold in all loading conditions and remain afloat in a satisfactory condition of equilibrium, as specified in paragraph 4. This requirement shall be complied with in accordance with the implementation schedule specified in regulation 3.
- 4 Subject to the provisions of paragraph 7, the condition of equilibrium after flooding shall satisfy the condition of equilibrium laid down in the annex to resolution A.320(IX) - Regulation equivalent to regulation 27 of the International Convention on Load Lines, 1966, as amended by resolution A.514(13). The assumed flooding need only take into account flooding of the cargo hold space to the water level outside the ship in that flooded condition. The permeability of a loaded hold shall be assumed as 0.9 and the permeability of an empty hold shall be assumed as 0.95, unless a permeability relevant to a particular cargo is assumed for the volume of a flooded hold occupied by cargo and a permeability of 0.95 is assumed for the remaining empty volume of the hold.
- 5 Bulk carriers constructed before 1 July 1999, which have been assigned a reduced freeboard in compliance with regulation 27(7) of the International Convention on Load Lines, 1966, as adopted on 5 April 1966, may be considered as complying with paragraph 3 of this regulation.
- 6 Bulk carriers which have been assigned a reduced freeboard in compliance with the provisions of paragraph (8) of the regulation equivalent to regulation 27 of the International Convention on Load Lines, 1966, adopted by resolution A.320(IX), as amended by resolution A.514(13), may be considered as complying with paragraphs 1 or 2, as appropriate.
- 7 On bulk carriers which have been assigned reduced freeboard in compliance with the provisions of regulation 27(8) of Annex B of the Protocol of 1988 relating to the International Convention on Load Lines, 1966, the condition of equilibrium after flooding shall satisfy the relevant provisions of that Protocol.

Regulation 5 – Structural strength of bulk carriers

- 1 Bulk carriers of 150 m in length and upwards of single-side skin construction, designed to carry solid bulk cargoes having a density of 1,000 kg/m³ and above constructed on or after 1 July 1999, shall have sufficient strength to withstand flooding of any one cargo hold to the water level outside the ship in that flooded condition in all loading and ballast conditions,

taking also into account dynamic effects resulting from the presence of water in the hold, and taking into account the recommendations adopted by the Organization.²⁾

- 2 Bulk carriers of 150 m in length and upwards of double-side skin construction, in which any part of longitudinal bulkhead is located within $B/5$ or 11.5 m, whichever is less, inboard from the ship's side at right angle to the centreline at the assigned summer load line, designed to carry bulk cargoes having a density of $1,000 \text{ kg/m}^3$ and above constructed on or after 1 July 2006, shall comply with the structural strength provisions of paragraph 1.

Regulation 6 – Structural and other requirements for bulk carriers

- 1 Bulk carriers of 150 m in length and upwards of single-side skin construction, carrying solid bulk cargoes having a density of $1,780 \text{ kg/m}^3$ and above, constructed before 1 July 1999, shall comply with the following requirements in accordance with the implementation schedule specified in regulation 3:
 - 1.1 The transverse watertight bulkhead between the two foremost cargo holds and the double bottom of the foremost cargo hold shall have sufficient strength to withstand flooding of the foremost cargo hold, taking also into account dynamic effects resulting from the presence of water in the hold, in compliance with the Bulk carrier bulkhead and double bottom strength standards. For the purpose of this regulation, the Bulk carrier bulkhead and double bottom strength standards shall be treated as mandatory.
 - 1.2 In considering the need for, and the extent of, strengthening of the transverse watertight bulkhead or double bottom to meet the requirements of 1.1, the following restrictions may be taken into account:
 - 1.2.1 restrictions on the distribution of the total cargo weight between the cargo holds; and
 - 1.2.2 restrictions on the maximum deadweight.
 - 1.3 For bulk carriers using either of, or both, the restrictions given in 1.2.1 and 1.2.2 above for the purpose of fulfilling the requirements of 1.1, these restrictions shall be complied with whenever solid bulk cargoes having a density of $1,780 \text{ kg/m}^3$ and above are carried.
- 2 Bulk carriers of 150 m in length and upwards constructed on or after 1 July 2006, in all areas with double-side skin construction shall comply with the following requirements:
 - 2.1 Primary stiffening structures of the double-side skin shall not be placed inside the cargo hold space.
 - 2.2 Subject to the provisions below, the distance between the outer shell and the inner shell at any transverse section shall not be less than 1,000 mm measured perpendicular to the side shell. The double-side skin construction shall be such as to allow access for inspection as provided in regulation II-1/3-6 and the Technical Provisions referring thereto.
 - 2.2.1 The clearances below need not be maintained in way of cross ties, upper and lower end brackets of transverse framing or end brackets of longitudinal framing.
 - 2.2.2 The minimum width of the clear passage through the double-side skin space in way of obstructions such as piping or vertical ladders shall not be less than 600 mm.
 - 2.2.3 Where the inner and/or outer skins are transversely framed, the minimum clearance between the inner surfaces of the frames shall not be less than 600 mm.
 - 2.2.4 Where the inner and outer skins are longitudinally framed, the minimum clearance between the inner surfaces of the frames shall not be less than 800 mm. Outside the parallel part of the cargo hold length, this clearance may be reduced where

²⁾ Refer to resolution 3, Recommendation on compliance with SOLAS regulation XII/5, adopted by the 1997 SOLAS Conference.

necessitated by the structural configuration, but, in no case, shall be less than 600 mm.

2.2.5 The minimum clearance referred to above shall be the shortest distance measured between assumed lines connecting the inner surfaces of the frames on the inner and outer skins.

- 3 The double-side skin spaces, with the exception of top-side wing tanks, if fitted, shall not be used for the carriage of cargo.
- 4 In bulk carriers of 150 m in length and upwards, carrying solid bulk cargoes having a density of 1,000 kg/m³ and above, constructed on or after 1 July 2006:
 - 4.1 the structure of cargo holds shall be such that all contemplated cargoes can be loaded and discharged by standard loading/discharge equipment and procedures without damage which may compromise the safety of the structure;
 - 4.2 effective continuity between the side shell structure and the rest of the hull structure shall be assured; and
 - 4.3 the structure of cargo areas shall be such that single failure of one stiffening structural member will not lead to immediate consequential failure of other structural items potentially leading to the collapse of the entire stiffened panels.

Regulation 7 – Survey of the cargo hold structure of bulk carriers

- 1 Bulk carriers of 150 m in length and upwards of single-side skin construction, constructed before 1 July 1999, of 10 years of age and over, shall not carry solid bulk cargoes having a density of 1,780 kg/m³ and above unless they have satisfactorily undergone either:
 - 1.1 a periodical survey, in accordance with the enhanced programme of inspections during surveys required by regulation XI-1/2; or
 - 1.2 a survey of all cargo holds to the same extent as required for periodical surveys in the enhanced programme of inspections during surveys required by regulation XI-1/2.
- 2 Bulk carriers shall comply with the maintenance requirements provided in regulation II-1/3-1 and the Standards for owners. inspection and maintenance of bulk carrier hatch covers, adopted by the Organization by resolution MSC.169(79), as may be amended by the Organization, provided that such amendments are adopted, brought into force and take effect in accordance with the provisions of article VIII of the present Convention concerning the amendment procedures applicable to the Annex other than chapter I.

Regulation 8- Information on compliance with requirements for bulk carriers

- 1 The booklet required by regulation VI/7.2 shall be endorsed by the Administration or on its behalf, to indicate that regulations 4, 5, 6 and 7, as appropriate, are complied with.
- 2 Any restrictions imposed on the carriage of solid bulk cargoes having a density of 1,780 kg/m³ and above in accordance with the requirements of regulations 6 and 14 shall be identified and recorded in the booklet referred to in paragraph 1.
- 3 A bulk carrier to which paragraph 2 applies shall be permanently marked on the side shell at midships, port and starboard, with a solid equilateral triangle having sides of 500 mm and its apex 300 mm below the deck line, and painted a contrasting colour to that of the hull.

Regulation 9 – Requirements for bulk carriers not being capable of complying with regulation 4.2 due to the design configuration of their cargo holds

For bulk carriers constructed before 1 July 1999 being within the application limits of regulation 4.3, which have been constructed with an insufficient number of transverse watertight bulkheads to

satisfy that regulation, the Administration may allow relaxation from the application of regulations 4.3 and 6 on condition that they shall comply with the following requirements:

- 1.1 for the foremost cargo hold, the inspections prescribed for the annual survey in the enhanced programme of inspections during surveys required by regulation XI-1/2 shall be replaced by the inspections prescribed therein for the intermediate survey of cargo holds;
- 1.2 are provided with bilge well high water level alarms in all cargo holds, or in cargo conveyor tunnels, as appropriate, giving an audible and visual alarm on the navigation bridge, as approved by the Administration or an organization recognized by it in accordance with the provisions of regulation XI-1/1; and
- 1.3 are provided with detailed information on specific cargo hold flooding scenarios. This information shall be accompanied by detailed instructions on evacuation preparedness under the provisions of section 8 of the International Safety Management (ISM) Code and be used as the basis for crew training and drills.

Regulation 10 – Solid bulk cargo density declaration

- 1 Prior to loading bulk cargo on bulk carriers of 150 m in length and upwards, the shipper shall declare the density of the cargo, in addition to providing the cargo information required by regulation VI/2.
- 2 For bulk carriers to which regulation 6 applies, unless such bulk carriers comply with all relevant requirements of this chapter applicable to the carriage of solid bulk cargoes having a density of 1,780 kg/m³ and above, any cargo declared to have a density within the range 1,250 kg/m³ to 1,780 kg/m³ shall have its density verified by an accredited testing organization.³⁾

Regulation 11 – Loading instrument

(Unless provided otherwise, this regulation applies to bulk carriers regardless of their date of construction)

- 1 Bulk carriers of 150 m in length and upwards shall be fitted with a loading instrument capable of providing information on hull girder shear forces and bending moments, taking into account the recommendation adopted by the Organization.⁴⁾
- 2 Bulk carriers of 150 m in length and upwards constructed before 1 July 1999 shall comply with the requirements of paragraph 1 not later than the date of the first intermediate or periodical survey of the ship to be carried out after 1 July 1999.
- 3 Bulk carriers of less than 150 m in length constructed on or after 1 July 2006 shall be fitted with a loading instrument capable of providing information on the ship's stability in the intact condition. The computer software shall be approved for stability calculations by the Administration and shall be provided with standard conditions for testing purposes relating to the approved stability information.⁵⁾

Regulation 12 – Hold, ballast and dry space water level detectors

(This regulation applies to bulk carriers regardless of their date of construction) 1 Bulk carriers shall be fitted with water level detectors:

³⁾ In verifying the density of solid bulk cargoes, reference should be made to the Uniform method of measurement of the density of bulk cargoes (MSC/Circ.908).

⁴⁾ Refer to the Recommendation on loading instruments, adopted by resolution 5 of the 1997 SOLAS Conference.

⁵⁾ Refer to the relevant parts of the appendix to the Guidelines for the on-board use and application of computers (MSC/Circ.891).

- 1 Bulk carriers shall be fitted with water level detectors:
 - 1.1 in each cargo hold, giving audible and visual alarms, one when the water level above the inner bottom in any hold reaches a height of 0.5 m and another at a height not less than 15% of the depth of the cargo hold but not more than 2 m. On bulk carriers to which regulation 9.2 applies, detectors with only the latter alarm need be installed. The water level detectors shall be fitted in the aft end of the cargo holds. For cargo holds which are used for water ballast, an alarm overriding device may be installed. The visual alarms shall clearly discriminate between the two different water levels detected in each hold;
 - 1.2 in any ballast tank forward of the collision bulkhead required by regulation II-1/12, giving an audible and visual alarm when the liquid in the tank reaches a level not exceeding 10% of the tank capacity. An alarm overriding device may be installed to be activated when the tank is in use; and
 - 1.3 in any dry or void space other than a chain cable locker, any part of which extends forward of the foremost cargo hold, giving an audible and visual alarm at a water level of 0.1 m above the deck. Such alarms need not be provided in enclosed spaces the volume of which does not exceed 0.1% of the ship's maximum displacement volume.
- 2 The audible and visual alarms specified in paragraph 1 shall be located on the navigation bridge.
- 3 Bulk carriers constructed before 1 July 2004 shall comply with the requirements of this regulation not later than the date of the annual, intermediate or renewal survey of the ship to be carried out after 1 July 2004, whichever comes first.

Regulation 13 – Availability of pumping systems

(This regulation applies to bulk carriers regardless of their date of construction)

- 1 On bulk carriers, the means for draining and pumping ballast tanks forward of the collision bulkhead and bilges of dry spaces any part of which extends forward of the foremost cargo hold shall be capable of being brought into operation from a readily accessible enclosed space, the location of which is accessible from the navigation bridge or propulsion machinery control position without traversing exposed freeboard or superstructure decks. Where pipes serving such tanks or bilges pierce the collision bulkhead, valve operation by means of remotely operated actuators may be accepted, as an alternative to the valve control specified in regulation II-1/12, provided that the location of such valve controls complies with this regulation.
- 2 Bulk carriers constructed before 1 July 2004 shall comply with the requirements of this regulation not later than the date of the first intermediate or renewal survey of the ship to be carried out after 1 July 2004, but, in no case, later than 1 July 2007.

Regulation 14 - Restrictions from sailing with any hold empty

Bulk carriers of 150 m in length and upwards of single-side skin construction, carrying cargoes having a density of 1,780 kg/m³ and above, if not meeting the requirements for withstanding flooding of any one cargo hold as specified in regulation 5.1 and the Standards and criteria for side structures of bulk carriers of single-side skin construction, adopted by the Organization by resolution MSC.168(79), as may be amended by the Organization, provided that such amendments are adopted, brought into force and take effect in accordance with the provisions of article VIII of the present Convention concerning the amendment procedures applicable to the Annex other than chapter I, shall not sail with any hold loaded to less than 10% of the hold's maximum allowable cargo weight when in the full load condition, after reaching 10 years of age. The applicable full load

condition for this regulation is a load equal to or greater than 90% of the ship's deadweight at the relevant assigned freeboard.

**Notice from the Danish Maritime Authority B – The Construction and Equipment,
etc. of Ships**

Chapter B XXI

Prevention of pollution by oil from ships

Regulation 1 – Definitions	2
Regulation 2 – Application	9
S Regulation 3 – Exemptions and waivers.....	10
S Regulation 4 – Exceptions	11
S Regulation 5 – Equivalentents	11
S Regulation 6 – Surveys	11
S Regulation 7 – Issue or endorsement of certificate.....	13
S Regulation 8 – Issue or endorsement of certificate by another Government.....	14
S Regulation 9 – Form of certificate	14
S Regulation 10 – Duration and validity of certificate	14
S Regulation 11 – Port State control on operational requirements	16
S Regulation 12 – Tanks for oil residues (sludge).....	16
S Regulation 12A – Oil fuel tank protection.....	17
S Regulation 13 – Standard discharge connection.....	29
S Regulation 14 – Oil filtering equipment	29
M Regulation 15 – Control of discharge of oil	31
S Regulation 16 – Segregation of oil and water ballast and carriage of oil in forepeak tanks	32
S Regulation 17 – Oil Record Book, Part I (Machinery space operations)	33
S Regulation 18 – Segregated Ballast tanks.....	34
S Regulation 19 – Double hull and double bottom requirements for oil tankers delivered on or after 6 July 1996	38
S Regulation 20 – Double hull and double bottom requirements for oil tankers delivered before 6 July 1996.....	42
S Regulation 21 – Prevention of oil pollution from oil tankers carrying heavy grade oil as cargo	44
S Regulation 22 – Pump-room bottom protection	45
S Regulation 23 – Accidental oil outflow performance.....	46
S Regulation 24 – Damage assumptions.....	53
S Regulation 25 – Hypothetical outflow of oil	54
S Regulation 26 – Limitations of size and arrangement of cargo tanks	56
S Regulation 27 – Intact stability	57
S Regulation 28 – Subdivision and damage stability.....	58
S Regulation 29 – Slop tanks	62
S Regulation 30 – Pumping, piping and discharge arrangement	63
S Regulation 31 – Oil discharge monitoring and control system	65

S Regulation 32 – Oil/water interface detector	65
S Regulation 33 – Crude oil washing requirements.....	66
M Regulation 34 – Control of discharge of oil	66
S Regulation 35 – Crude oil washing operations	67
S Regulation 36 – Oil Record Book, Part II – Cargo/ballast operations	68
S Regulation 37 – Shipboard oil pollution emergency plan	69
M Regulation 38 – Reception facilities.....	70
S Regulation 39 – Special requirements for fixed or floating platforms	72

Introduction

This chapter contains the provisions of annex I to the International Convention for the Prevention of Pollution from Ships – the 1973 MARPOL Convention – with the amendments and additions contained in the 1978 Protocol to MARPOL 73 (MARPOL 73/78), as amended.

The administration of the regulations has been distributed so that the Danish Environmental Protection Agency is responsible for the regulations on discharge and the Danish Maritime Authority is responsible for the regulations on the technical installations on board the ships, including certificates, record books and plans. This distribution of responsibility is indicated in the overview of the chapters in connection with each individual regulation by an “M” for the Danish Environmental Protection Agency and an “S” for the Danish Maritime Authority.

Attention is drawn to the fact that, in principle, this chapter contains the provisions for all ships, including cargo ships with a gross tonnage below 500, passenger ships engaged on domestic voyages and fishing vessels.

In connection with the implementation of the provisions of the MARPOL Convention in Denmark, the Danish Ministry of the Environment has issued some orders that must also be complied with in addition to the technical regulations issued by the Danish Maritime Authority.

Part I – General

Regulation 1 – Definitions

For the purposes of this Chapter:

1. “Oil” means petroleum in any form including crude oil, fuel oil, sludge, oil refuse and refined products (other than those petrochemicals which are subject to the provisions of Annex II of the MARPOL Convention) and, without limiting the generality of the foregoing, includes the substances listed in appendix I to this Annex.
2. “Crude oil” means any liquid hydrocarbon mixture occurring naturally in the earth whether or not treated to render it suitable for transportation and includes:
 - 2.1. crude oil from which certain distillate fractions may have been removed; and
 - 2.2. crude oil to which certain distillate fractions may have been added.
3. “Oily mixture” means a mixture with any oil content.

4. "Oil fuel" means any oil used as fuel in connection with the propulsion and auxiliary machinery of the ship in which such oil is carried.
5. "Oil tanker" means a ship constructed or adapted primarily to carry oil in bulk in its cargo spaces and includes combination carriers, any "NLS tanker" as defined in Chapter XXII any gas carrier as defined in chapter II-1, when carrying a cargo or part cargo of oil in bulk.
6. "Crude oil tanker" means an oil tanker engaged in the trade of carrying crude oil.
7. "Product carrier" means an oil tanker engaged in the trade of carrying oil other than crude oil.
8. "Combination carrier" means a ship designed to carry either oil or solid cargoes in bulk.
9. "Major conversion":
 - 9.1. means a conversion of a ship:
 - 9.1.1. which substantially alters the dimensions or carrying capacity of the ship; or
 - 9.1.2. which changes the type of the ship; or
 - 9.1.3. the intent of which in the opinion of the Administration is substantially to prolong its life; or
 - 9.1.4. which otherwise so alters the ship that, if it were a new ship, it would become subject to relevant provisions of the present Chapter not applicable to it as an existing ship.
 - 9.2. Notwithstanding the provisions of this definition:
 - 9.2.1. conversion of an oil tanker of 20,000 tonnes deadweight and above delivered on or after 1 June 1982, as defined in regulation 1.28.3, to meet the requirements of regulation 18 of this Chapter shall not be deemed to constitute a major conversion for the purpose of this Chapter; and
 - 9.2.2. conversion of an oil tanker delivered before 6 July 1996, as defined in regulation 1.28.5, to meet the requirements of regulation 19 or 20 of this Chapter shall not be deemed to constitute a major conversion for the purpose of this Chapter.
10. "Nearest land." The term "from the nearest land" means from the baseline from which the territorial sea of the territory in question is established in accordance with international law, except that, for the purposes of the present Convention "from the nearest land" off the north-eastern coast of Australia shall mean from a line drawn from a point on the coast of Australia in:

latitude 11°00' S, longitude 142°08' E
 to a point in latitude 10°35' S, longitude 141°55' E,
 thence to a point latitude 10°00' S, longitude 142°00' E,
 thence to a point latitude 09°10' S, longitude 143°52' E,
 thence to a point latitude 09°00' S, longitude 144°30' E,
 thence to a point latitude 10°41' S, longitude 145°00' E,
 thence to a point latitude 13°00' S, longitude 145°00' E,
 thence to a point latitude 15°00' S, longitude 146°00' E,
 thence to a point latitude 17°30' S, longitude 147°00' E,
 thence to a point latitude 21°00' S, longitude 152°55' E,
 thence to a point latitude 24°30' S, longitude 154°00' E,
 thence to a point on the coast of Australia in latitude 24°42' S, longitude 153°15' E.

11. "Special area" means a sea area where for recognized technical reasons in relation to its oceanographical and ecological condition and to the particular character of its traffic the adoption of special mandatory methods for the prevention of sea pollution by oil is required.

For the purposes of this Chapter, the special areas are defined as follows:

- 11.1. "the Mediterranean Sea area" means the Mediterranean Sea proper including the gulfs and seas therein with the boundary between the Mediterranean and the Black Sea constituted by the 41° N parallel and bounded to the west by the Straits of Gibraltar at the meridian of 005°36' W;
- 11.2. "the Baltic Sea area" means the Baltic Sea proper with the Gulf of Bothnia, the Gulf of Finland and the entrance to the Baltic Sea bounded by the parallel of the Skaw in the Skagerrak at 57°44'.8 N;
- 11.3. "the Black Sea area" means the Black Sea proper with the boundary between the Mediterranean Sea and the Black Sea constituted by the parallel 41° N;
- 11.4. "the Red Sea area" means the Red Sea proper including the Gulfs of Suez and Aqaba bounded at the south by the rhumb line between Ras si Ane (12° 8'.5 N, 043°19'.6 E) and Husn Murad (12° 0'.4 N, 043°30'.2 E);
- 11.5. "the Gulf's area" means the sea area located northwest of the rhumb line between Ras al Hadd (22°30' N, 059°48' E) and Ras al Fasteh (25°04' N, 061°25' E);
- 11.6. "the Gulf of Aden area" means that part of the Gulf of Aden between the Red Sea and the Arabian Sea bounded to the west by the rhumb line between Ras si Ane (12°28'.5 N, 043°19'.6 E) and Husn Murad (12°40'.4 N, 043°30'.2 E) and to the east by the rhumb line between Ras Asir (11°50' N, 051°16'.9 E) and the Ras Fartak (15°35' N, 052°13'.8 E);
- 11.7. "the Antarctic area" means the sea area south of latitude 60° S; and
- 11.8. "the North West European waters" include the North Sea and its approaches, the Irish Sea and its approaches, the Celtic Sea, the English Channel and its approaches and part of the North East Atlantic immediately to the west of Ireland. The area is bounded by lines joining the following points:

48°27' N on the French coast
48°27' N; 006°25' W
49°52' N; 007°44' W
50°30' N; 012° W
56°30' N; 012° W
62° N; 003° W
62° N on the Norwegian coast
57°44'.8 N on the Danish and Swedish coasts

- 11.9. "the Oman area of the Arabian Sea" means the sea area enclosed by the following coordinates:

22°30'.00 N; 059°48'.00 E
23°47'.27 N; 060°35'.73 E
22°40'.62 N; 062°25'.29 E
21°47'.40 N; 063°22'.22 E
20°30'.37 N; 062°52'.41 E

19°45'.90 N; 062°25'.97 E
18°49'.92 N; 062°02'.94 E
17°44'.36 N; 061°05'.53 E
16°43'.71 N; 060°25'.62 E
16°03'.90 N; 059°32'.24 E
15°15'.20 N; 058°58'.52 E
14°36'.93 N; 058°10'.23 E
14°18'.93 N; 057°27'.03 E
14°11'.53 N; 056°53'.75 E
13°53'.80 N; 056°19'.24 E
13°45'.86 N; 055°54'.53 E
14°27'.38 N; 054°51'.42 E
14°40'.10 N; 054°27'.35 E
14°46'.21 N; 054°08'.56 E
15°20'.74 N; 053°38'.33 E
15°48'.69 N; 053°32'.07 E
16°23'.02 N; 053°14'.82 E
16°39'.06 N; 053°06'.52 E

11.10. The Southern South African waters means the sea area enclosed by the following co-ordinates:

31°14' S; 017°50' E
31°30' S; 017°12' E
32°00' S; 017°06' E
32°32' S; 016°52' E
34°06' S; 017°24' E
36°58' S; 020°54' E
36°00' S; 022°30' E
35°14' S; 022°54' E
34°30' S; 026°00' E
33°48' S; 027°25' E
33°27' S; 027°12' E

12. "Instantaneous rate of discharge of oil content" means the rate of discharge of oil in litres per hour at any instant divided by the speed of the ship in knots at the same instant.
13. "Tank" means an enclosed space which is formed by the permanent structure of a ship and which is designed for the carriage of liquid in bulk.
14. "Wing tank" means any tank adjacent to the side shell plating.
15. "Centre tank" means any tank inboard of a longitudinal bulkhead.
16. "Slop tank" means a tank specifically designated for the collection of tank drainings, tank washings and other oily mixtures.
17. "Clean ballast" means the ballast in a tank which, since oil was last carried therein, has been so cleaned that effluent therefrom if it were discharged from a ship which is stationary into clean calm water on a clear day would not produce visible traces of oil on the surface of the water or on

adjoining shorelines or cause a sludge or emulsion to be deposited beneath the surface of the water or upon adjoining shorelines. If the ballast is discharged through an oil discharge monitoring and control system approved by the Administration, evidence based on such a system to the effect that the oil content of the effluent did not exceed 15 parts per million shall be determinative that the ballast was clean, notwithstanding the presence of visible traces.

18. "Segregated ballast" means the ballast water introduced into a tank which is completely separated from the cargo oil and oil fuel system and which is permanently allocated to the carriage of ballast or to the carriage of ballast or cargoes other than oil or noxious liquid substances as variously defined in the definitions of the MARPOL Convention.
19. "Length (*L*)" means 96 per cent of the total length on a waterline at 85 per cent of the least moulded depth measured from the top of the keel, or the length from the foreside of the stem to the axis of the rudder stock on that waterline, if that be greater. In ships designed with a rake of keel the waterline on which this length is measured shall be parallel to the designed waterline. The length (*L*) shall be measured in metres.
20. "Forward and after perpendiculars" shall be taken at the forward and after ends of the length (*L*). The forward perpendicular shall coincide with the foreside of the stem on the waterline on which the length is measured.
21. "Amidships" is at the middle of the length (*L*).
22. "Breadth (*B*)" means the maximum breadth of the ship, measured amidships to the moulded line of the frame in a ship with a metal shell and to the outer surface of the hull in a ship with a shell of any other material. The breadth (*B*) shall be measured in metres.
23. "Deadweight (*DW*)" means the difference in tonnes between the displacement of a ship in water of a relative density of 1.025 at the load waterline corresponding to the assigned summer freeboard and the lightweight of the ship.
24. "Lightweight" means the displacement of a ship in tonnes without cargo, fuel, lubricating oil, ballast water, fresh water and feed water in tanks, consumable stores, and passengers and crew and their effects.
25. "Permeability of a space" means the ratio of the volume within that space which is assumed to be occupied by water to the total volume of that space.
26. "Volumes and areas" in a ship shall be calculated in all cases to moulded lines.
27. "Anniversary date" means the day and the month of each year, which will correspond to the date of expiry of the International Oil Pollution Prevention Certificate.
28.
 - 28.1. "Ship delivered on or before 31 December 1979" means
 - 28.1.1. a ship for which the building contract is placed on or before 31 December 1975; or
 - 28.1.2. in the absence of a building contract, the keel of which is laid or which is at a similar stage of construction on or before 30 June 1976; or
 - 28.1.3. the delivery of which is on or before 31 December 1979; or
 - 28.1.4. which has undergone a major conversion:
 - 28.1.4.1. for which the contract is placed on or before 31 December 1975; or
 - 28.1.4.2. in the absence of a contract, the construction work of which is begun on or before 30 June 1976; or
 - 28.1.4.3. which is completed on or before 31 December 1979.
 - 28.2. "Ship delivered after 31 December 1979" means a ship:
 - 28.2.1. for which the building contract is placed after 31 December 1975; or

- 28.2.2. in the absence of a building contract, the keel of which is laid or which is at a similar stage of construction after 30 June 1976; or
- 28.2.3. the delivery of which is after 31 December 1979; or
- 28.2.4. which has undergone a major conversion:
 - 28.2.4.1. for which the contract is placed after 31 December 1975; or
 - 28.2.4.2. in the absence of a contract, the construction work of which is begun after 30 June 1976; or
 - 28.2.4.3. which is completed after 31 December 1979.
- 28.3. “Oil tanker delivered on or before 1 June 1982” means an oil tanker:
 - 28.3.1. for which the building contract is placed on or before 1 June 1979; or
 - 28.3.2. in the absence of a building contract, the keel of which is laid or which is at a similar stage of construction on or before 1 January 1980; or
 - 28.3.3. the delivery of which is on or before 1 June 1982; or
 - 28.3.4. which has undergone a major conversion:
 - 28.3.4.1. for which the contract is placed on or before 1 June 1979; or
 - 28.3.4.2. in the absence of a contract, the construction work of which is begun on or before 1 January 1980; or
 - 28.3.4.3. which is completed on or before 1 June 1982
- 28.4. “Oil tanker delivered after 1 June 1982” means an oil tanker:
 - 28.4.1. for which the building contract is placed after 1 June 1979; or
 - 28.4.2. in the absence of a building contract, the keel of which is laid or which is at a similar stage of construction after 1 January 1980; or
 - 28.4.3. the delivery of which is after 1 June 1982; or
 - 28.4.4. which has undergone a major conversion:
 - 28.4.4.1. for which the contract is placed after 1 June 1979; or
 - 28.4.4.2. in the absence of a contract, the construction work of which is begun after 1 January 1980; or
 - 28.4.4.3. which is completed after 1 June 1982.
- 28.5. “Oil tanker delivered before 6 July 1996” means an oil tanker:
 - 28.5.1. for which the building contract is placed before 6 July 1993; or
 - 28.5.2. in the absence of a building contract, the keel of which is laid or which is at a similar stage of construction before 6 January 1994; or
 - 28.5.3. the delivery of which is before 6 July 1996; or
 - 28.5.4. which has undergone a major conversion:
 - 28.5.4.1. for which the contract is placed before 6 July 1993; or
 - 28.5.4.2. in the absence of a contract, the construction work of which is begun before 6 January 1994; or
 - 28.5.4.3. which is completed before 6 July 1996.
- 28.6. “Oil tanker delivered on or after 6 July 1996” means an oil tanker:
 - 28.6.1. for which the building contract is placed on or after 6 July 1993; or
 - 28.6.2. in the absence of a building contract, the keel of which is laid or which is at a similar stage of construction on or after 6 January 1994; or
 - 28.6.3. the delivery of which is on or after 6 July 1996; or
 - 28.6.4. which has undergone a major conversion:
 - 28.6.4.1. for which the contract is placed on or after 6 July 1993; or

- 28.6.4.2. in the absence of a contract, the construction work of which is begun on or after 6 January 1994; or
- 28.6.4.3. which is completed on or after 6 July 1996.
- 28.7. "Oil tanker delivered on or after 1 February 2002" means an oil tanker:
 - 28.7.1. for which the building contract is placed on or after 1 February 1999; or
 - 28.7.2. in the absence of a building contract, the keel of which is laid or which is at a similar stage of construction on or after 1 August 1999; or
 - 28.7.3. the delivery of which is on or after 1 February 2002; or
 - 28.7.3.1. which has undergone a major conversion:
 - 28.7.3.2. for which the contract is placed on or after 1 February 1999; or
 - 28.7.3.3. in the absence of a contract, the construction work of which is begun on or after 1 August 1999; or
 - 28.7.3.4. which is completed on or after 1 February 2002.
- 28.8. "Oil tanker delivered on or after 1 January 2010" means an oil tanker:
 - 28.8.1. for which the building contract is placed on or after 1 January 2007; or
 - 28.8.2. in the absence of a building contract, the keel of which is laid or which is at a similar stage of construction on or after 1 July 2007; or
 - 28.8.3. the delivery of which is on or after 1 January 2010; or
 - 28.8.3.1. which has undergone a major conversion:
 - 28.8.3.2. for which the contract is placed on or after 1 January 2007; or
 - 28.8.3.3. in the absence of a contract, the construction work of which is begun on or after 1 July 2007; or
 - 28.8.3.4. which is completed on or after 1 January 2010.
- 28.9. "ship delivered on or after 1 August 2010 means a ship:
 - 28.9.1. for which the building contract is placed on or after 1 August 2007; or
 - 28.9.2. in the absence of a building contract, the keels of which are laid or which are at a similar stage of construction on 1 February 2008; or
 - 28.9.3. the delivery of which is on or after 1 August 2010; or
 - 28.9.4. which have undergone a major conversion:
 - 28.9.4.1. for which the contract is placed on or after 1 August 2007; or
 - 28.9.4.2. in the absence of contract, the construction work of which is begun on or after 1 February 2008; or
 - 28.9.4.3. which is completed after 1 August 2010.
- 29. "Parts per million (ppm)" means parts of oil per million parts of water by volume.
- 30. "Constructed" means a ship the keel of which is laid or which is at a similar stage of construction.
- 31. "Oil residue (sludge)" means the residual waste oil products generated during the normal operation of a ship such as those resulting from the purification of fuel or lubricating oil for main or auxiliary machinery, separated waste oil from oil filtering equipment, waste oil collected in drip trays, and waste hydraulic and lubricating oils.
- 32. "Oil residue (sludge) tank" means a tank which holds oil residue (sludge) from which sludge may be disposed directly through the standard discharge connection or any other approved means of disposal.
- 33. "Oily bilge water" means water which may be contaminated by oil resulting from things such as leakage or maintenance work in machinery spaces. Any liquid entering the bilge system including bilge wells, bilge piping, tank top or bilge holding tanks is considered oily bilge water.

34. "Oily bilge water holding tank" means a tank collecting oily bilge water prior to its discharge, transfer or disposal.

Regulation 2 – Application

1. Unless expressly provided otherwise, the provisions of this chapter shall apply to all ships.
2. In ships other than oil tankers fitted with cargo spaces which are constructed and utilized to carry oil in bulk of an aggregate capacity of 200 cubic metres or more, the requirements of regulations 16, 26.4, 29, 30, 31, 32, 34 and 36 of this Chapter for oil tankers shall also apply to the construction and operation of those spaces, except that where such aggregate capacity is less than 1,000 cubic metres the requirements of regulation 34.6 of this Chapter may apply in lieu of regulations 29, 31 and 32.
3. Where a cargo subject to the provisions of Chapter XXII is carried in a cargo space of an oil tanker, the appropriate requirements of Chapter XXII shall also apply.
4. The requirements of regulations 29, 31 and 32 of this Chapter shall not apply to oil tankers carrying asphalt or other products subject to the provisions of this Chapter, which through their physical properties inhibit effective product/water separation and monitoring, for which the control of discharge under regulation 34 of this Chapter shall be effected by the retention of residues on board with discharge of all contaminated washings to reception facilities.
5. Subject to the provisions of paragraph 6 of this regulation, regulations 18.6-18.8 shall not apply to an oil tanker delivered on or before 1 June 1982, as defined in regulation 1.28.3, solely engaged in specific trades between:
 - 5.1. ports or terminals within a State Party to the Convention; or
 - 5.2. ports or terminals of States Parties to the Convention, where:
 - 5.2.1. the voyage is entirely within a Special Area; or
 - 5.2.2. the voyage is entirely within other limits designated by the Organization.
6. The provisions of paragraph 5 of this regulation shall only apply when the ports or terminals where cargo is loaded on such voyages are provided with reception facilities adequate for the reception and treatment of all the ballast and tank washing water from oil tankers using them and all the following conditions are complied with:
 - 6.1. subject to the exceptions provided for in regulation 4 of this Chapter, all ballast water, including clean ballast water, and tank washing residues are retained on board and transferred to the reception facilities and the appropriate entry in the Oil Record Book is endorsed by the competent Port State Authority;
 - 6.2. agreement has been reached between the Administration and the Governments of the Port States referred to in paragraphs 5.1 or 5.2 of this regulation concerning the use of an oil tanker delivered on or before 1 June 1982, as defined in regulation 1.28.3, for a specific trade;
 - 6.3. the adequacy of the reception facilities in accordance with the relevant provisions of this chapter at the ports or terminals referred to above, for the purpose of this regulation, is approved by the Governments of the States Parties to the Convention within which such ports or terminals are situated;
 - 6.4. the International Oil Pollution Prevention Certificate is endorsed to the effect that the oil tanker is solely engaged in such specific trade.

S Regulation 3 – Exemptions and waivers

1. Any ship such as hydrofoil, air-cushion vehicle, near-surface craft and submarine craft etc. whose constructional features are such as to render the application of any of the provisions of chapters 3 and 4 relating to construction and equipment unreasonable or impracticable may be exempted by the Administration from such provisions, provided that the construction and equipment of that ship provides equivalent protection against pollution by oil, having regard to the service for which it is intended.
2. Particulars of any such exemption granted by the Administration shall be indicated in the Certificate referred to in regulation 7 of this Chapter.
3. The Administration which allows any such exemption shall, as soon as possible, but not more than 90 days thereafter, communicate to the Organization particulars of same and the reasons therefore, which the Organization shall circulate to the Parties to the Convention for their information and appropriate action, if any.
4. The Administration may waive the requirements of regulations 29, 31 and 32 of this Chapter, for any oil tanker which engages exclusively on voyages both of 72 hours or less in duration and within 50 nautical miles from the nearest land, provided that the oil tanker is engaged exclusively in trades between ports or terminals within a State Party to the Convention. Any such waiver shall be subject to the requirement that the oil tanker shall retain on board all oily mixtures for subsequent discharge to reception facilities and to the determination by the Administration that facilities available to receive such oily mixtures are adequate.
5. The Administration may waive the requirements of regulations 31 and 32 of this Chapter for oil tankers other than those referred to in paragraph 4 of this regulation in cases where:
 - 5.1. the tanker is an oil tanker delivered on or after 1 June 1982, as defined in regulation 1.28.3, of 40,000 tonnes deadweight or above, as referred to in regulation 2.5 of this Chapter, solely engaged in specific trades, and the conditions specified in regulation 2.6 of this Chapter are complied with; or
 - 5.2. the tanker is engaged exclusively in one or more of the following categories of voyages:
 - 5.2.1. voyages within special areas; or
 - 5.2.2. voyages within 50 nautical miles from the nearest land outside special areas where the tanker is engaged in:
 - 5.2.2.1. trades between ports or terminals of a State Party to the Convention; or
 - 5.2.2.2. restricted voyages as determined by the Administration, and of 72 hours or less in duration;provided that all of the following conditions are complied with:
 - 5.2.2.3. all oily mixtures are retained on board for subsequent discharge to reception facilities;
 - 5.2.2.4. for voyages specified in paragraph 5.2.2 of this regulation, the Administration has determined that adequate reception facilities are available to receive such oily mixtures in those oil loading ports or terminals the tanker calls at;
 - 5.2.2.5. the International Oil Pollution Prevention Certificate, when required, is endorsed to the effect that the ship is exclusively engaged in one or more of the categories of voyages specified in paragraphs 5.2.1 and 5.2.2.2 of this regulation; and

- 5.2.2.6. the quantity, time and port of discharge are recorded in the Oil Record Book.

S Regulation 4 – Exceptions

1. Regulations 15 and 34 of this Chapter shall not apply to:
 - 1.1. the discharge into the sea of oil or oily mixture necessary for the purpose of securing the safety of a ship or saving life at sea; or
 - 1.2. the discharge into the sea of oil or oily mixture resulting from damage to a ship or its equipment:
 - 1.2.1. provided that all reasonable precautions have been taken after the occurrence of the damage or discovery of the discharge for the purpose of preventing or minimizing the discharge; and
 - 1.2.2. except if the owner or the master acted either with intent to cause damage, or recklessly and with knowledge that damage would probably result; or
 - 1.3. the discharge into the sea of substances containing oil, approved by the Administration, when being used for the purpose of combating specific pollution incidents in order to minimize the damage from pollution. Any such discharge shall be subject to the approval of any Government in whose jurisdiction it is contemplated the discharge will occur.

S Regulation 5 – Equivalents

1. The Administration may allow any fitting, material, appliance or apparatus to be fitted in a ship as an alternative to that required by this Chapter if such fitting, material, appliance or apparatus is at least as effective as that required by this Chapter. This authority of the Administration shall not extend to substitution of operational methods to effect the control of discharge of oil as equivalent to those design and construction features which are prescribed by regulations in this Chapter.
2. The Administration which allows a fitting, material, appliance or apparatus to be fitted in a ship as an alternative to that required by this Chapter shall communicate particulars thereof to the Organization for circulation to the Parties to the Convention for their information and appropriate action, if any.

Part II – Surveys and certification

S Regulation 6 – Surveys

1. Every oil tanker of 150 gross tonnage and above, and every other ship of 400 gross tonnage and above shall be subject to the surveys specified below:
 - 1.1. an initial survey before the ship is put in service or before the Certificate required under regulation 7 of this Chapter is issued for the first time, which shall include a complete survey of its structure, equipment, systems, fittings, arrangements and material in so far as the ship is covered by this Chapter. This survey shall be such as to ensure that the structure, equipment, systems, fittings, arrangements and material fully comply with the applicable requirements of this Chapter;
 - 1.2. a renewal survey at intervals specified by the Administration, but not exceeding 5 years, except where regulation 10.2.2, 10.5, 10.6 or 10.7 of this Chapter is applicable. The renewal

survey shall be such as to ensure that the structure, equipment, systems, fittings, arrangements and material fully comply with applicable requirements of this Chapter;

- 1.3. an intermediate survey within 3 months before or after the second anniversary date or within 3 months before or after the third anniversary date of the Certificate which shall take the place of one of the annual surveys specified in paragraph 1.4 of this regulation. The intermediate survey shall be such as to ensure that the equipment and associated pump and piping systems, including oil discharge monitoring and control systems, crude oil washing systems, oily-water separating equipment and oil filtering systems, fully comply with the applicable requirements of this Chapter and are in good working order. Such intermediate surveys shall be endorsed on the Certificate issued under regulation 7 or 8 of this Chapter;
 - 1.4. an annual survey within 3 months before or after each anniversary date of the Certificate, including a general inspection of the structure, equipment, systems, fittings, arrangements and material referred to in paragraph 1.1 of this regulation to ensure that they have been maintained in accordance with paragraphs 4.1 and 4.2 of this regulation and that they remain satisfactory for the service for which the ship is intended. Such annual surveys shall be endorsed on the Certificate issued under regulation 7 or 8 of this Chapter;
 - 1.5. an additional survey either general or partial, according to the circumstances, shall be made after a repair resulting from investigations prescribed in paragraph 4.3 of this regulation, or whenever any important repairs or renewals are made. The survey shall be such as to ensure that the necessary repairs or renewals have been effectively made, that the material and workmanship of such repairs or renewals are in all respects satisfactory and that the ship complies in all respects with the requirements of this Chapter.
2. The Administration shall establish appropriate measures for ships which are not subject to the provisions of paragraph 1 of this regulation in order to ensure that the applicable provisions of this Chapter are complied with.
 3.
 - 3.1. Surveys of ships as regards the enforcement of the provisions of this Chapter shall be carried out by officers of the Administration. The Administration may, however, entrust the surveys either to surveyors nominated for the purpose or to organizations recognized by it. Such organizations shall comply with the guidelines adopted by the Organization by resolution A.739(18), as may be amended by the Organization, and the specifications adopted by the Organization by resolution A.789(19), as may be amended by the Organization, provided that such amendments are adopted, brought into force and take effect in accordance with the provisions of article 16 of the MARPOL Convention concerning the amendment procedures applicable to this Chapter.
 - 3.2. An Administration nominating surveyors or recognizing organizations to conduct surveys as set forth in paragraph 3.1 of this regulation shall, as a minimum, empower any nominated surveyor or recognized organization to:
 - 3.2.1. require repairs to a ship; and
 - 3.2.2. carry out surveys, if requested by the appropriate authorities of a port State.The Administration shall notify the Organization of the specific responsibilities and conditions of the authority delegated to the nominated surveyors or recognized organizations, for circulation to Parties to the Convention for the information of their officers.
 - 3.3. When a nominated surveyor or recognized organization determines that the condition of the ship or its equipment does not correspond substantially with the particulars of the Certificate

or is such that the ship is not fit to proceed to sea without presenting an unreasonable threat of harm to the marine environment, such surveyor or organization shall immediately ensure that corrective action is taken and shall in due course notify the Administration. If such corrective action is not taken the Certificate shall be withdrawn and the Administration shall be notified immediately; and if the ship is in a port of another Party, the appropriate authorities of the port State shall also be notified immediately. When an officer of the Administration, a nominated surveyor or a recognized organization has notified the appropriate authorities of the port State, the Government of the port State concerned shall give such officer, surveyor or organization any necessary assistance to carry out their obligations under this regulation. When applicable, the Government of the port State concerned shall take such steps as will ensure that the ship shall not sail until it can proceed to sea or leave the port for the purpose of proceeding to the nearest appropriate repair yard available without presenting an unreasonable threat of harm to the marine environment.

3.4. In every case, the Administration concerned shall fully guarantee the completeness and efficiency of the survey and shall undertake to ensure the necessary arrangements to satisfy this obligation.

4.

4.1. The condition of the ship and its equipment shall be maintained to conform with the provisions of the present chapter to ensure that the ship in all respects will remain fit to proceed to sea without presenting an unreasonable threat of harm to the marine environment.

4.2. After any survey of the ship under paragraph 1 of this regulation has been completed, no change shall be made in the structure, equipment, systems, fittings, arrangements or material covered by the survey, without the sanction of the Administration, except the direct replacement of such equipment and fittings.

4.3. Whenever an accident occurs to a ship or a defect is discovered which substantially affects the integrity of the ship or the efficiency or completeness of its equipment covered by this Chapter the master or owner of the ship shall report at the earliest opportunity to the Administration, the recognized organization or the nominated surveyor responsible for issuing the relevant Certificate, who shall cause investigations to be initiated to determine whether a survey as required by paragraph 1 of this regulation is necessary. If the ship is in a port of another Party, the master or owner shall also report immediately to the appropriate authorities of the port State and the nominated surveyor or recognized organization shall ascertain that such report has been made.

S Regulation 7 – Issue or endorsement of certificate

1. An International Oil Pollution Prevention Certificate shall be issued, after an initial or renewal survey in accordance with the provisions of regulation 6 of this Chapter, to any oil tanker of 150 gross tonnage and above and any other ships of 400 gross tonnage and above which are engaged in voyages to ports or offshore terminals under the jurisdiction of other Parties to the Convention.

2. Such certificate shall be issued or endorsed as appropriate either by the Administration or by any persons or organization duly authorized by it. In every case the Administration assumes full responsibility for the certificate.

S Regulation 8 – Issue or endorsement of certificate by another Government

1. The Government of a Party to the Convention may, at the request of the Administration, cause a ship to be surveyed and, if satisfied that the provisions of this Chapter are complied with, shall issue or authorize the issue of an International Oil Pollution Prevention Certificate to the ship and, where appropriate, endorse or authorize the endorsement of that certificate on the ship in accordance with this Chapter.
2. A copy of the certificate and a copy of the survey report shall be transmitted as soon as possible to the requesting Administration.
3. A certificate so issued shall contain a statement to the effect that it has been issued at the request of the Administration and it shall have the same force and receive the same recognition as the certificate issued under regulation 7 of this Chapter.
4. No International Oil Pollution Prevention Certificate shall be issued to a ship which is entitled to fly the flag of a State which is not a Party.

S Regulation 9 – Form of certificate

The International Oil Pollution Prevention Certificate shall be drawn up in the form corresponding to the model given in appendix II to this Chapter¹ and shall be at least in English, French or Spanish. If an official language of the issuing country is also used, this shall prevail in case of a dispute or discrepancy.

S Regulation 10 – Duration and validity of certificate

1. An International Oil Pollution Prevention Certificate shall be issued for a period specified by the Administration, which shall not exceed five years.
2.
 - 2.1. Notwithstanding the requirements of paragraph 1 of this regulation, when the renewal survey is completed within 3 months before the expiry date of the existing certificate, the new certificate shall be valid from the date of completion of the renewal survey to a date not exceeding 5 years from the date of expiry of the existing certificate.
 - 2.2. When the renewal survey is completed after the expiry date of the existing certificate, the new certificate shall be valid from the date of completion of the renewal survey to a date not exceeding 5 years from the date of expiry of the existing certificate.
 - 2.3. When the renewal survey is completed more than 3 months before the expiry date of the existing certificate, the new certificate shall be valid from the date of completion of the renewal survey to a date not exceeding 5 years from the date of completion of the renewal survey.
3. If a certificate is issued for a period of less than 5 years, the Administration may extend the validity of the certificate beyond the expiry date to the maximum period specified in paragraph 1 of this regulation, provided that the surveys referred to in regulations 6.1.3 and 6.1.4 of this Chapter applicable when a certificate is issued for a period of 5 years are carried out as appropriate.
4. If a renewal survey has been completed and a new certificate cannot be issued or placed on board the ship before the expiry date of the existing certificate, the person or organization authorized by

¹ Please refer to appendix 1C of Notice from the Danish Maritime Authority B.

the Administration may endorse the existing certificate and such a certificate shall be accepted as valid for a further period which shall not exceed 5 months from the expiry date.

5. If a ship at the time when a certificate expires is not in a port in which it is to be surveyed, the Administration may extend the period of validity of the certificate but this extension shall be granted only for the purpose of allowing the ship to complete its voyage to the port in which it is to be surveyed, and then only in cases where it appears proper and reasonable to do so. No certificate shall be extended for a period longer than 3 months, and a ship to which an extension is granted shall not, on its arrival in the port in which it is to be surveyed, be entitled by virtue of such extension to leave that port without having a new certificate. When the renewal survey is completed, the new certificate shall be valid to a date not exceeding 5 years from the date of expiry of the existing certificate before the extension was granted.
6. A certificate issued to a ship engaged on short voyages which has not been extended under the foregoing provisions of this regulation may be extended by the Administration for a period of grace of up to one month from the date of expiry stated on it. When the renewal survey is completed, the new certificate shall be valid to a date not exceeding 5 years from the date of expiry of the existing certificate before the extension was granted.
7. In special circumstances, as determined by the Administration, a new certificate need not be dated from the date of expiry of the existing certificate as required by paragraphs 2.2, 5 or 6 of this regulation. In these special circumstances, the new certificate shall be valid to a date not exceeding 5 years from the date of completion of the renewal survey.
8. If an annual or intermediate survey is completed before the period specified in regulation 6 of this Chapter, then:
 - 8.1. the anniversary date shown on the certificate shall be amended by endorsement to a date which shall not be more than 3 months later than the date on which the survey was completed;
 - 8.2. the subsequent annual or intermediate survey required by regulation 8 of this Chapter shall be completed at the intervals prescribed by that regulation using the new anniversary date; and
 - 8.3. the expiry date may remain unchanged provided one or more annual or intermediate surveys, as appropriate, are carried out so that the maximum intervals between the surveys prescribed by regulation 6.1 of this Chapter are not exceeded.
9. A certificate issued under regulation 7 or 8 of this Chapter shall cease to be valid in any of the following cases:
 - 9.1. if the relevant surveys are not completed within the periods specified under regulation 6.1 of this Chapter;
 - 9.2. if the certificate is not endorsed in accordance with regulation 6.1.3 or 6.1.4 of this Chapter;
or
 - 9.3. upon transfer of the ship to the flag of another State. A new certificate shall only be issued when the Government issuing the new certificate is fully satisfied that the ship is in compliance with the requirements of regulations 6.4.1 and 6.4.2 of this Chapter. In the case of a transfer between Parties, if requested within 3 months after the transfer has taken place, the Government of the Party whose flag the ship was formerly entitled to fly shall, as soon as possible, transmit to the Administration copies of the certificate carried by the ship before the transfer and, if available, copies of the relevant survey reports.

S Regulation 11 – Port State control on operational requirements²

1. A ship when in a port or an offshore terminal of another Party is subject to inspection by officers duly authorized by such Party concerning operational requirements under this Chapter, where there are clear grounds for believing that the master or crew are not familiar with essential shipboard procedures relating to the prevention of pollution by oil.
2. In the circumstances given in paragraph 1 of this regulation, the Party shall take such steps as will ensure that the ship shall not sail until the situation has been brought to order in accordance with the requirements of this Chapter.
3. Procedures relating to the port State control prescribed in article 5 of the MARPOL Convention shall apply to this regulation.
4. Nothing in this regulation shall be construed to limit the rights and obligations of a Party carrying out control over operational requirements specifically provided for in the MARPOL Convention.

Part III – Requirements for machinery spaces of all ships

Part A – Construction

S Regulation 12 – Tanks for oil residues (sludge)

1. Every ship of 400 gross tonnage and above shall be provided with a tank or tanks of adequate capacity, having regard to the type of machinery and length of voyage, to receive the oil residues (sludge) which cannot be dealt with otherwise in accordance with the requirements of this Chapter.
2. Oil residue (sludge) may be disposed of directly from the oil residue (sludge) tank(s) through the standard discharge connection referred to in regulation 13, or any other approved means of disposal. The oil residue (sludge) tank(s):
 - 2.1. shall be provided with a designated pump for disposal that is capable of taking suction from the oil residue (sludge) tank(s); and
 - 2.2. shall have no discharge connections to the bilge system, oily bilge water holding tank(s), tank top or oily water separators except that the tank(s) may be fitted with drains, with manually operated self-closing valves and arrangements for subsequent visual monitoring of the settled water, that lead to an oily bilge water holding tank or bilge well, or an alternative arrangement, provided such arrangement does not connect directly to the bilge piping system.
3. Piping to and from oil residue (sludge) tanks shall have no direct connection overboard, other than the standard discharge connection referred to in regulation 13.
4. In ships delivered after 31 December 1979, as defined in regulation 1.28.2, tanks for oil residues shall be designed and constructed so as to facilitate their cleaning and the discharge of residues to reception facilities. Ships delivered on or before 31 December 1979, as defined in regulation 1.28.1, shall comply with this requirement as far as is reasonable and practicable.
5. *Minimum capacity for sludge tanks*
 - 5.1. *With regard to ships which do not carry ballast water in oil fuel tanks, the capacity of the sludge tank shall be calculated in accordance with the following formula:
 $V_1 = K_1 \times C \times D$ (cubic metres)*

² Refer to the Procedures for port State control, adopted by the Organization by resolution A.787(19), as amended by resolution A.882(21).

$K_1 = 0.01$ for ships using heavy oil fuel for propulsion which is centrifuged on board or 0.005 for ships using diesel oil for propulsion or ships in which heavy oil is not centrifuged on board.

$C =$ Daily fuel oil consumption.

$D =$ Maximum sailing time in days between ports where reception facilities are available; if this is not known, minimum 30.

- 5.2. With regard to ships provided with equipment on board recognized by the Danish Maritime Authority for the disposal of oil sludge, the capacity of the sludge tank V_1 may be set at 1 cubic metre for ships of a gross tonnage of 400 and above and 2 cubic metres for ships with a gross tonnage of 4,000 and above.
- 5.3. With regard to ships carrying ballast water in oil fuel tanks, the capacity of the sludge tank shall be calculated in accordance with the following formula:

$$V_2 = V_1 + K_2 \times B \text{ (cubic metres)}$$

$V_1 =$ The sludge tank capacity as defined in 1 or 2.

$K_2 = 0.01$ for ships using heavy oil fuel and 0.005 for ships using diesel oil.

$B =$ The capacity of water ballast tanks, which may also be used for fuel oil.

S Regulation 12A – Oil fuel tank protection

1. This regulation shall apply to all ships with an aggregate oil fuel capacity of 600 m³ and above which are delivered on or after 1 August 2010, as defined in regulation 1.28.9 of this Chapter.
2. The application of this regulation in determining the location of tanks used to carry oil fuel does not govern over the provisions of regulation 19 of this Chapter.
3. For the purpose of this regulation, the following definitions shall apply:
 - 3.1. “Oil fuel” means any oil used as fuel oil in connection with the propulsion and auxiliary machinery of the ship in which such oil is carried.
 - 3.2. “Load line draught (d_S)” is the vertical distance, in metres, from the moulded baseline at mid-length to the waterline corresponding to the summer freeboard draught to be assigned to the ship.
 - 3.3. “Light ship draught” is the moulded draught amidships corresponding to the lightweight.
 - 3.4. “Partial load line draught (d_P)” is the light ship draught plus 60% of the difference between the light ship draught and the load line draught d_S . The partial load line draught (d_P) shall be measured in metres.
 - 3.5. “Waterline (d_B)” is the vertical distance, in metres, from the moulded baseline at mid-length to the waterline corresponding to 30% of the depth D_S .
 - 3.6. “Breadth (B_S)” is the greatest moulded breadth of the ship, in metres, at or below the deepest load line draught (d_S).
 - 3.7. “Breadth (B_B)” is the greatest moulded breadth of the ship, in metres, at or below the waterline (d_B).
 - 3.8. “Depth (D_S)” is the moulded depth, in metres, measured at mid-length to the upper deck at side. For the purpose of the application, “upper deck” means the highest deck to which the watertight transverse bulkheads except aft peak bulkheads extend.

- 3.9. "Length (L)" means 96% of the total length on a waterline at 85% of the least moulded depth measured from the top of the keel, or the length from the foreside of the stem to the axis of the rudder stock on that waterline, if that be greater. In ships designed with a rake of keel the waterline on which this length is measured shall be parallel to the designed waterline. The length (L) shall be measured in metres.
- 3.10. "Breadth (B)" means the maximum breadth of the ship, in metres, measured amidships to the moulded line of the frame in a ship with a metal shell and to the outer surface of the hull in a ship with a shell of any other material.
- 3.11. "Oil fuel tank" means a tank in which oil fuel is carried, but excludes those tanks which would not contain oil fuel in normal operation, such as overflow tanks.
- 3.12. "Small oil fuel tank" is an oil fuel tank with a maximum individual capacity not greater than 30 m³.
- 3.13. "C" is the ship's total volume of oil fuel, including that of the small oil fuel tanks, in m³, at 98% tank filling.
- 3.14. "Oil fuel capacity" means the volume of a tank in m³, at 98% filling.
4. The provisions of this regulation shall apply to all oil fuel tanks except small oil fuel tanks, as defined in 3.12, provided that the aggregate capacity of such excluded tanks is not greater than 600 m³.
5. Individual oil fuel tanks shall not have a capacity of over 2,500 m³.
6. For ships, other than self-elevating drilling units, having an aggregate oil fuel capacity of 600 m³ and above, oil fuel tanks shall be located above the moulded line of the bottom shell plating nowhere less than the distance h as specified below:

$$h = B/20 \text{ m or,}$$

$$h = 2.0 \text{ m, whichever is the lesser.}$$

The minimum value of $h = 0.76 \text{ m}$

In the turn of the bilge area and at locations without a clearly defined turn of the bilge, the oil fuel tank boundary line shall run parallel to the line of the midship flat bottom as shown in Figure 1.

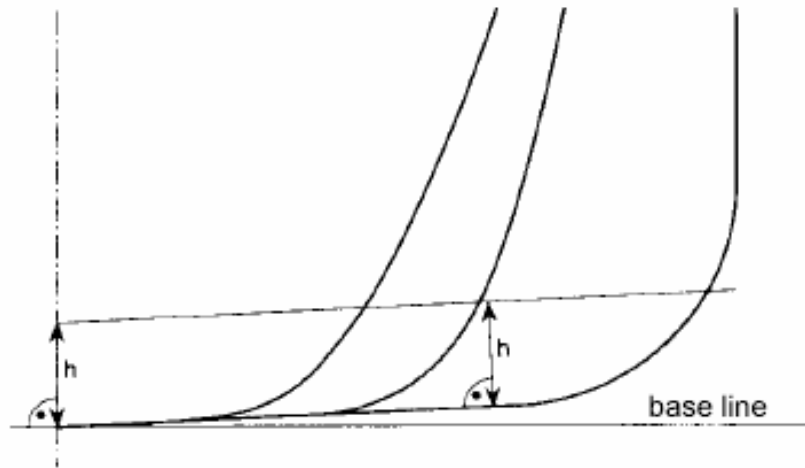

Figure 1 – Oil fuel tank boundary lines for the purpose of paragraph 6

7. For ships having an aggregate oil fuel capacity of 600 m³ or more but less than 5,000 m³, oil fuel tanks shall be located inboard of the moulded line of the side shell plating, nowhere less than the distance *w* which, as shown in Figure 2, is measured at any cross-section at right angles to the side shell, as specified below:

$$w = 0.4 + 2.4 C/20,000 \text{ m}$$

The minimum value of *w* = 1.0 m, however for individual tanks with an oil fuel capacity of less than 500 m³ the minimum value is 0.76 m.

8. For ships having an aggregate oil fuel capacity of 5,000 m³ and over, oil fuel tanks shall be located inboard of the moulded line of the side shell plating, nowhere less than the distance *w* which, as shown in Figure 2, is measured at any cross-section at right angles to the side shell, as specified below:

$$w = 0.5 + C/20,000 \text{ m or}$$

w = 2.0 m, whichever is the lesser.

The minimum value of *w* = 1.0 m

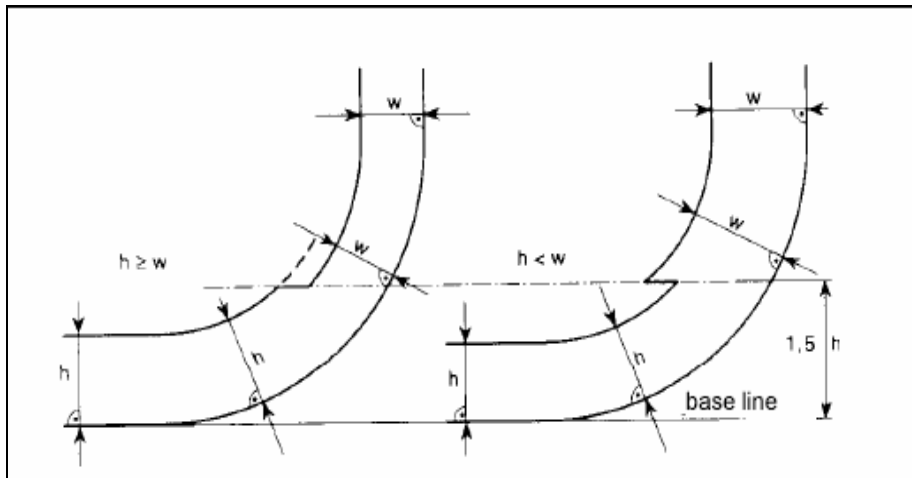

Figure 2 – Oil fuel tank boundary lines for the purpose of paragraphs 7 and 8

9. Lines of oil fuel piping located at a distance from the ship's bottom of less than h , as defined in paragraph 6, or from the ship's side less than w , as defined in paragraphs 7 and 9 shall be fitted with valves or similar closing devices within or immediately adjacent to the oil fuel tank. These valves shall be capable of being brought into operation from a readily accessible enclosed space the location of which is accessible from the navigation bridge or propulsion machinery control position without traversing exposed freeboard or superstructure decks.
The valves shall close in case of remote control system failure (fail in a closed position) and shall be kept closed at sea at any time when the tank contains oil fuel except that they may be opened during oil fuel transfer operations.
10. Suction wells in oil fuel tanks may protrude into the double bottom below the boundary line defined by the distance h provided that such wells are as small as practicable and the distance between the well bottom and the bottom shell plating is not less than $0.5 h$.
11. Alternatively to paragraphs 6 and either 7 or 8, ships shall comply with the accidental oil fuel outflow performance standard specified below:
 - 11.1. The level of protection against oil fuel pollution in the event of collision or grounding shall be assessed on the basis of the mean oil outflow parameter as follows:

$$O_M < 0.0157 - 1.14E-6 \cdot C \quad 600 \text{ m}^3 \leq C < 5,000 \text{ m}^3$$

$$O_M < 0.010 \quad C \geq 5,000 \text{ m}^3$$

Where

O_M = mean oil outflow parameter;

C = total oil fuel volume.

- 11.2. The following general assumption shall apply when calculating the mean oil outflow parameter:
- 11.2.1. the ship shall be assumed loaded to the partial load line draught d_p without trim or heel;
 - 11.2.2. all oil fuel tanks shall be assumed loaded to 98% of their volumetric capacity;
 - 11.2.3. the nominal density of the oil fuel (ρ_n) shall generally be taken as 1,000 kg/m³. If the density of the oil fuel is specifically restricted to a lesser value, the lesser value may be applied; and
 - 11.2.4. for the purpose of these outflow calculations, the permeability of each oil fuel tank shall be taken as 0.99, unless proven otherwise.
- 11.3. The following assumptions shall be used when combining the oil outflow parameters:
- 11.3.1. The mean oil outflow shall be calculated independently for side damage and for bottom damage and then combined into a non-dimensional oil outflow parameter O_M , as follows:

$$O_M = (0.4 O_{MS} + 0.6 O_{MB}) / C$$

where:

O_{MS} = mean outflow for side damage, in m³

O_{MB} = mean outflow for bottom damage, in m³

C = total oil fuel volume.

- 11.3.2. For bottom damage, independent calculations for mean outflow shall be done for 0 m and 2.5 m tide conditions, and then combined as follows:

$$O_{MB} = 0.7 O_{MB(0)} + 0.3 O_{MB(2.5)}$$

where:

$O_{MB(0)}$ = mean outflow for 0 m tide condition, and

$O_{MB(2.5)}$ = mean outflow for minus 2.5 m tide condition, in m³.

- 11.4. The mean outflow for side damage O_{MS} shall be calculated as follows:

$$O_{MS} = \sum_{i=1}^n P_{S(i)} O_{S(i)} \quad [m^3]$$

where:

i = represents each oil fuel tank under consideration;

n = total number of oil fuel tanks;

$P_{S(i)}$ = the probability of penetrating oil fuel tank (i) from side damage, calculated in accordance with paragraph 11.6 of this regulation;

$O_{S(i)}$ = the outflow, in m^3 , from side damage to oil fuel tank (i), which is assumed equal to the total volume in oil fuel tank (i) at 98% filling.

11.5. The mean outflow for bottom damage shall be calculated for each tidal condition as follows:

$$.1 O_{MB(0)} = \sum_{i=1}^n P_{B(i)} O_{B(i)} C_{DB(i)} \quad [m^3]$$

where:

i = represents each oil fuel tank under consideration;

n = total number of oil fuel tanks;

$P_{B(i)}$ = the probability of penetrating oil fuel tank (i) from bottom damage, calculated in accordance with paragraph 11.7 of this regulation;

$O_{B(i)}$ = the outflow from oil fuel tank (i), in m^3 , calculated in accordance with paragraph 11.5.3 of this regulation; and

$C_{DB(i)}$ = factor to account for oil capture as defined in paragraph 11.5.4.

$$.2 O_{MB(2,5)} = \sum_{i=1}^n P_{B(i)} O_{B(i)} C_{DB(i)} \quad [m^3]$$

where:

i, n, $P_{B(i)}$ and $C_{DB(i)}$ = as defined in subparagraph .1 above

$O_{B(i)}$ = the outflow from oil fuel tank (i), in m^3 , after tidal change.

11.5.3. The oil outflow $O_{B(i)}$ for each oil fuel tank shall be calculated based on pressure balance principles, in accordance with the following assumptions:

11.5.3.1. The ship shall be assumed stranded with zero trim and heel, with the stranded draught prior to tidal change equal to the partial load line draught d_p .

11.5.3.2. The oil fuel level after damage shall be calculated as follows:

$$h_F = \{(d_p + t_C - Z_l)(\rho_S)\} / \rho_n$$

where:

h_F = the height of the oil fuel surface above Z_l , in m;

t_C = the tidal change, in m. Reductions in tide shall be expressed as negative values;

Z_l = the height of the lowest point in the oil fuel tank above the baseline, in m;

ρ_S = density of seawater, to be taken as $1,025 \text{ kg/m}^3$; and,

ρ_n = nominal density of the oil fuel, as defined in 11.2.3.

11.5.3.3. The oil outflow $O_{B(i)}$ for any tank bounding the bottom shell plating shall be taken not less than the following formula, but no more than the tank capacity:

$$O_{B(i)} = H_W : A$$

where:

$H_W = 1.0 \text{ m}$, when $Y_B = 0$

$H_W = B_B/50$ but not greater than 0.4 m , when Y_B is greater than $B_B/5$ or 11.5 m , whichever is less

“ H_W ” is to be measured upwards from the midship flat bottom line. In the turn of the bilge area and at locations without a clearly defined turn of the bilge, H_W is to be measured from a line parallel to the midship flat bottom, as shown for distance “ h ” in Figure 1.

For Y_B values outboard $B_B/5$ or 11.5 m , whichever is less, H_W is to be linearly interpolated.

Y_B = the minimum value of Y_B over the length of the oil fuel tank, where at any given location, Y_B is the transverse distance between the side shell at waterline d_B and the tank at or below waterline d_B .

A = the maximum horizontal projected area of the oil fuel tank up to the level of H_w from the bottom of the tank.

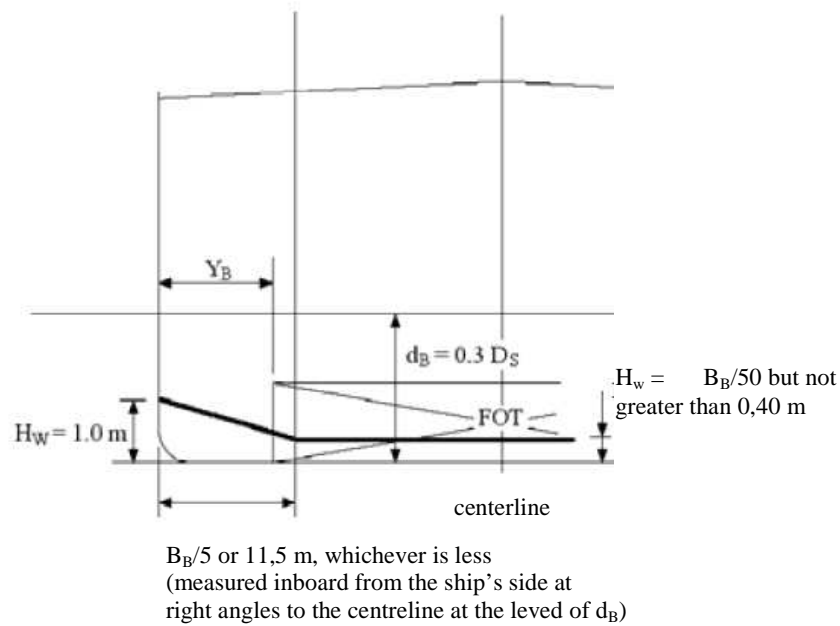

Figure 3 – Dimensions for calculation of the minimum oil outflow for the purpose of subparagraph 11.5.3.3

11.5.3.4. In the case of bottom damage, a portion from the outflow from an oil fuel tank may be captured by non-oil compartments. This effect is approximated by application of the factor $C_{DB(i)}$ for each tank, which shall be taken as follows:

$C_{DB(i)} = 0.6$ for oil fuel tanks bounded from below by non-oil compartments;

$C_{DB(i)} = 1$ otherwise.

11.6. The probability P_S of breaching a compartment from side damage shall be calculated as follows:

11.6.1.

$$P_S = P_{SL} * P_{SV} * P_{ST}$$

where:

$P_{SL} = (1 - P_{Sf} - P_{Sa})$ = probability the damage will extend into the longitudinal zone bounded by X_a and X_f ;

$P_{SV} = (1 - P_{Su} - P_{Sl})$ = probability the damage will extend into the vertical zone bounded by Z_l and Z_u ;

$P_{ST} = (1 - P_{Sy})$ = probability the damage will extend transversely beyond the boundary defined by y ;

- 11.6.2. P_{Sa} , P_{Sf} , P_{Su} and P_{Sl} shall be determined by linear interpolation from the table of probabilities for side damage provided in 11.6.3, and P_{Sy} shall be calculated from the formulas provided in 11.6.3, where:

P_{Sa} = the probability the damage will lie entirely aft of location X_a/L ;

P_{Sf} = the probability the damage will lie entirely forward of location X_f/L ;

P_{Sl} = probability the damage will lie entirely below the tank;

P_{Su} = probability the damage will lie entirely above the tank; and

P_{Sy} = probability the damage will lie entirely outboard the tank.

Compartment boundaries X_a , X_f , Z_l , Z_u and y shall be developed as follows:

X_a = the longitudinal distance from aft terminal of L to the aft most point on the compartment being considered, in m;

X_f = the longitudinal distance from aft terminal of L to the foremost point on the compartment being considered, in m;

Z_l = the vertical distance from the moulded baseline to the lowest point on the compartment being considered, in m.

Z_u = the vertical distance from the moulded baseline to the highest point on the compartment being considered, in m. Where Z_u is greater than D_S , Z_u shall be taken as D_S ; and,

y = the minimum horizontal distance measured at right angles to the centreline between the compartment under consideration and the side shell, in m³.

³ For symmetrical tank arrangements, damages are considered for one side of the ship only, in which case all “y” dimensions are to be measured from that side. For asymmetrical arrangements reference is made to the Explanatory Notes on matters related to the accidental oil outflow performance, adopted by the Organization by resolution MEPC.122(52).

In way of the turn of the bilge, y need not to be considered below a distance h above baseline, where h is lesser of B/10, 3 m or the top of the tank.

11.6.3. Table of Probabilities for side damage

X_a/L	P_{Sa}	X_f/L	P_{Sf}	Z_l/D_s	P_{Sl}	Z_u/D_s	P_{Su}
0.00	0.000	0.00	0.967	0.00	0.000	0.00	0.968
0.05	0.023	0.05	0.917	0.05	0.000	0.05	0.952
0.10	0.068	0.10	0.867	0.10	0.001	0.10	0.931
0.15	0.117	0.15	0.817	0.15	0.003	0.15	0.905
0.20	0.167	0.20	0.767	0.20	0.007	0.20	0.873
0.25	0.217	0.25	0.717	0.25	0.013	0.25	0.836
0.30	0.267	0.30	0.667	0.30	0.021	0.30	0.789
0.35	0.317	0.35	0.617	0.35	0.034	0.35	0.733
0.40	0.367	0.40	0.567	0.40	0.055	0.40	0.670
0.45	0.417	0.45	0.517	0.45	0.085	0.45	0.599
0.50	0.467	0.50	0.467	0.50	0.123	0.50	0.525
0.55	0.517	0.55	0.417	0.55	0.172	0.55	0.452
0.60	0.567	0.60	0.367	0.60	0.226	0.60	0.383
0.65	0.617	0.65	0.317	0.65	0.285	0.65	0.317
0.70	0.667	0.70	0.267	0.70	0.347	0.70	0.255
0.75	0.717	0.75	0.217	0.75	0.413	0.75	0.197
0.80	0.767	0.80	0.167	0.80	0.482	0.80	0.143
0.85	0.817	0.85	0.117	0.85	0.553	0.85	0.092
0.90	0.867	0.90	0.068	0.90	0.626	0.90	0.046
0.95	0.917	0.95	0.023	0.95	0.700	0.95	0.013
1.00	0.967	1.00	0.000	1.00	0.775	1.00	0.000

P_{Sy} shall be calculated as follows:

$$P_{Sy} = (24.96 - 199.6 y/B_S) (y/B_S) \quad \text{for } y/B_S \leq 0.05$$

$$P_{Sy} = 0.749 + \{5 - 44.4 (y/B_S - 0.05)\} \{(y/B_S) - 0.05\} \quad \text{for } 0.05 < y/B_S < 0.1$$

$$P_{Sy} = 0.888 + 0.56 (y/B_S - 0.1) \quad \text{for } y/B_S \geq 0.1$$

P_{Sy} is not to be taken greater than 1.

11.7. The probability P_B of breaching a compartment from bottom damage shall be calculated as follows:

11.7.1.

$$P_B = P_{BL} * P_{BT} * P_{BV}$$

where:

$P_{BL} = (1 - P_{Bf} - P_{Ba})$ = probability the damage will extend into the longitudinal zone bounded by X_a and X_f ;

$P_{BT} = (1 - P_{Bp} - P_{Bs})$ = probability the damage will extend into transverse zone bounded by Y_p and Y_s ; and

$P_{BV} = (1 - P_{Bz})$ = probability the damage will extend vertically above the boundary defined by z ;

11.7.2.

P_{Ba} , P_{Bf} , P_{Bp} and P_{Bs} shall be determined by linear interpolation from the table of probabilities for bottom damage provided in 11.7.3, and P_{Bz} shall be calculated from the formulas provided in 11.7.3,

where:

P_{Ba} = the probability the damage will lie entirely aft of location X_a/L ;

P_{Bf} = the probability the damage will lie entirely forward of location X_f/L ;

P_{Bp} = probability the damage will lie entirely to port of the tank;

P_{Bs} = probability the damage will lie entirely to starboard the tank; and

P_{Bz} = probability the damage will lie entirely below the tank.

Compartment boundaries X_a , X_f , Y_p , Y_s and z shall be developed as follows:

X_a and X_f as defined in 11.6.2;

Y_p = the transverse distance from the port-most point on the compartment located at or below the waterline d_B , to a vertical plane located $B_B/2$ to starboard of the ship's centreline;

Y_s = the transverse distance from the starboard-most point on the compartment located at or below the waterline d_B , to a vertical plane located $B_B/2$ to starboard of the ship's centreline; and

z = the minimum value of z over the length of the compartment, where, at any given longitudinal location, z is the vertical distance from the lower point of the bottom shell at that longitudinal location to the lower point of the compartment at that longitudinal location.

11.7.3. Table of probabilities for bottom damage

X_a/L	P_{Sa}	X_f/L	P_{Sf}	Z_l/D_s	P_{Sl}	Z_u/D_s	P_{Su}
0.00	0.000	0.00	0.969	0.00	0.844	0.00	0.000
0.05	0.002	0.05	0.953	0.05	0.794	0.05	0.009
0.10	0.008	0.10	0.936	0.10	0.744	0.10	0.032
0.15	0.017	0.15	0.916	0.15	0.694	0.15	0.063
0.20	0.029	0.20	0.894	0.20	0.644	0.20	0.097
0.25	0.042	0.25	0.870	0.25	0.594	0.25	0.133
0.30	0.058	0.30	0.842	0.30	0.544	0.30	0.171
0.35	0.076	0.35	0.810	0.35	0.494	0.35	0.211
0.40	0.096	0.40	0.775	0.40	0.444	0.40	0.253
0.45	0.119	0.45	0.734	0.45	0.394	0.45	0.297
0.50	0.143	0.50	0.687	0.50	0.344	0.50	0.344
0.55	0.171	0.55	0.630	0.55	0.297	0.55	0.394
0.60	0.203	0.60	0.563	0.60	0.253	0.60	0.444
0.65	0.242	0.65	0.489	0.65	0.211	0.65	0.494
0.70	0.289	0.70	0.413	0.70	0.171	0.70	0.544
0.75	0.344	0.75	0.333	0.75	0.133	0.75	0.594
0.80	0.409	0.80	0.252	0.80	0.097	0.80	0.644
0.85	0.482	0.85	0.170	0.85	0.063	0.85	0.694
0.90	0.565	0.90	0.089	0.90	0.032	0.90	0.744
0.95	0.658	0.95	0.026	0.95	0.009	0.95	0.794
1.00	0.761	1.00	0.000	1.00	0.000	1.00	0.844

P_{Bz} shall be calculated as follows:

$$P_{Bz} = (14.5 - 67 z/D_S) (z/D_S) \quad \text{for } z/D_S \leq 0.1$$

$$P_{Bz} = 0.78 + 1.1 \{(z/D_S - 0.1)\} \quad \text{for } z/D_S > 0.1$$

P_{Bz} is not to be taken greater than 1.

- 11.8. For the purpose of maintenance and inspection, any oil fuel tanks that do not border the outer shell plating shall be located no closer to the bottom shell plating than the minimum value of h in paragraph 6 and no closer to the side shell plating than the applicable minimum value of w in paragraph 7 or 8.
12. In approving the design and construction of ships to be built in accordance with this regulation, Administrations shall have due regard to the general safety aspects, including the need for maintenance and inspection of wing and double bottom tanks or spaces.

S Regulation 13 – Standard discharge connection

To enable pipes of reception facilities to be connected with the ship's discharge pipeline for residues from machinery bilges and from oil residue (sludge) tanks, both lines shall be fitted with a standard discharge connection in accordance with the following table:

Standard dimensions of flanges for discharge connections

Description	Description
Outside diameter	215 mm
Inner diameter	According to pipe outside diameter
Bolt circle diameter	183 mm
Slots in flange	6 holes 22 mm in diameter equidistantly placed on a bolt circle of the above diameter, slotted to the flange periphery. The slot width to be 22 mm
Flange thickness	20 mm
Bolts and nuts:	6, each of 20 mm in diameter and of suitable length
The flange is designed to accept pipes up to a maximum internal diameter of 125 mm and shall be of steel or other equivalent material having a flat face. This flange, together with a gasket of oil-proof material, shall be suitable for a service pressure of 600 kPa.	

Part B – Equipment

S Regulation 14 – Oil filtering equipment

1. Except as specified in paragraph 3 of this regulation, any ship of 400 gross tonnage and above but less than 10,000 gross tonnage shall be fitted with oil filtering equipment complying with paragraph 6 of this regulation. Any such ship which may discharge into the sea ballast water retained in oil fuel tanks in accordance with regulation 16.2 shall comply with paragraph 2 of this regulation.

2. Except as specified in paragraph 3 of this regulation, any ship of 10,000 gross tonnage and above shall be fitted with oil filtering equipment complying with paragraph 7 of this regulation.
3. Ships, such as hotel ships, storage vessels, etc., which are stationary except for non-cargo-carrying relocation voyages need not be provided with oil filtering equipment. Such ships shall be provided with a holding tank having a volume adequate, to the satisfaction of the Administration, for the total retention on board of the oily bilge water. All oily bilge water shall be retained on board for subsequent discharge to reception facilities.
4. The Administration shall ensure that ships of less than 400 gross tonnage are equipped, as far as practicable, to retain on board oil or oily mixtures or discharge them in accordance with the requirements of regulation 15.6 of this Chapter.

Ships with a gross tonnage below 400 shall be fitted with:

- 4.1. *A shore connection with a pump and an oily/water separating system as well as alarm equipment, if applicable, making it possible to treat the oily water from the engine room bilges and discharge it in accordance with the provisions of regulation 15, or with;*
- 4.2. *a storage tank of at least 1 cubic metre including pump and shore connection in order that the oily water from the engine room bilge may be retained on board for subsequent delivery to reception facilities ashore, or with;*
- 4.3. *other systems that may be approved by the Danish Maritime Authority, including shore connection with pump.*

Ships with a gross tonnage below 400 using centrifuges or similar devices for the treatment of fuel and lubricating oils shall be fitted with sludge tanks in accordance with regulation 12 (1) and (2).

5. The Administration may waive the requirements of paragraphs 1 and 2 of this regulation for:
 - 5.1. any ship engaged exclusively on voyages within special areas, or
 - 5.2. any ship certified under the International Code of Safety for High-Speed Craft (or otherwise within the scope of this Code with regard to size and design) engaged on a scheduled service with a turnaround time not exceeding 24 hours and covering also non-passenger/cargo-carrying relocation voyages for these ships,
 - 5.3. with regard to the provision of subparagraphs .1 and .2 above, the following conditions shall be complied with:
 - 5.4. the ship is fitted with a holding tank having a volume adequate, to the satisfaction of the Administration, for the total retention on board of the oily bilge water;
 - 5.5. all oily bilge water is retained on board for subsequent discharge to reception facilities;
 - 5.6. the Administration has determined that adequate reception facilities are available to receive such oily bilge water in a sufficient number of ports or terminals the ship calls at;
 - 5.7. the International Oil Pollution Prevention Certificate, when required, is endorsed to the effect that the ship is exclusively engaged on the voyages within special areas or has been accepted as a high-speed craft for the purpose of this regulation and the service is identified; and
 - 5.8. the quantity, time, and port of the discharge are recorded in the Oil Record Book Part I.
6. Oil filtering equipment referred to in paragraph 1 of this regulation shall be of a design approved by the Administration and shall be such as will ensure that any oily mixture discharged into the sea after passing through the system has an oil content not exceeding 15 parts per million. In

considering the design of such equipment, the Administration shall have regard to the specification recommended by the Organization.⁴

7. Oil filtering equipment referred to in paragraph 2 of this regulation shall comply with paragraph 6 of this regulation. In addition, it shall be provided with alarm arrangements to indicate when this level cannot be maintained. The system shall also be provided with arrangements to ensure that any discharge of oily mixtures is automatically stopped when the oil content of the effluent exceeds 15 parts per million. In considering the design of such equipment and approvals, the Administration shall have regard to the specification recommended by the Organization.
8. *Guidelines on the minimum capacity for oil separators for the treatment of bilge water from engine rooms:*

<i>Gross tonnage (GT)</i>	<i>Minimum capacity (cubic metres/hour)</i>
200-400	0.25
400-1,600	0.5
1,600-4,000	1.0
4,000-15,000	2.5
15,000 and above	5.0

Larger separator capacities may be necessary in ships with engine rooms of high complexity.

The capacity of oil separators which in addition are used for the treatment of ballast water shall in each individual case be approved by the Danish Maritime Authority.

Part C – Control of discharge of oil

M Regulation 15 – Control of discharge of oil

Attention is drawn to the fact that the following regulation is the Danish Maritime Authority's translation of MARPOL. As regards Danish legislation, reference is made to the Danish Ministry of the Environment.

1. Subject to the provisions of regulation 4 of this Chapter and paragraphs 2, 3, and 6 of this regulation, any discharge into the sea of oil or oily mixtures from ships shall be prohibited.⁵

A – Discharges outside special areas

2. Any discharge into the sea of oil or oily mixtures from ships of 400 gross tonnage and above shall be prohibited except when all the following conditions are satisfied:
 - 2.1. the ship is proceeding "en route;"
 - 2.2. the oily mixture is processed through an oil filtering equipment meeting the requirements of regulation 14 of this Chapter;
 - 2.3. the oil content of the effluent without dilution does not exceed 15 parts per million;
 - 2.4. the oily mixture does not originate from cargo pump-room bilges on oil tankers; and

⁴ Refer to the Recommendation on international performance and test specification for oily-water separating equipment and oil content meters, adopted by the Organization by Assembly resolution A.393(X), or the Guidelines and specifications for pollution prevention equipment for machinery space bilges of ships, adopted by the Marine Environment Protection Committee by resolution MEPC.60(33), or the Revised guidelines and specification for pollution prevention equipment for machinery space bilges of ships, adopted by the Marine Environment Protection Committee by resolution MEPC.107(49).

⁵ *This shall not apply to Danish territorial waters, where any type of oil discharge is prohibited, cf. the Act on Protection of the Marine Environment.*

2.5. the oily mixture, in case of oil tankers, is not mixed with oil cargo residues.

B – Discharges in special areas

3. Any discharge into the sea of oil or oily mixtures from ships of 400 gross tonnage and above shall be prohibited except when all of the following conditions are satisfied:
 - 3.1. the ship is proceeding “en route;”
 - 3.2. the oily mixture is processed through an oil filtering equipment meeting the requirements of regulation 14.7 of this Chapter;
 - 3.3. the oil content of the effluent without dilution does not exceed 15 parts per million;
 - 3.4. the oily mixture does not originate from cargo pump-room bilges on oil tankers; and
 - 3.5. the oily mixture, in case of oil tankers, is not mixed with oil cargo residues.
4. In respect of the Antarctic area, any discharge into the sea of oil or oily mixtures from any ship shall be prohibited.
5. Nothing in this regulation shall prohibit a ship on a voyage only part of which is in a special area from discharging outside a special area in accordance with paragraph 2 of this regulation.

C – Requirements for ships of less than 400 gross tonnage in all areas except the Antarctic area

6. In the case of a ship of less than 400 gross tonnage, oil and all oily mixtures shall either be retained on board for subsequent discharge to reception facilities or discharged into the sea in accordance with the following provisions:
 - 6.1. the ship is proceeding “en route;”
 - 6.2. the ship has in operation equipment of a design approved by the Administration that ensures that the oil content of the effluent without dilution does not exceed 15 parts per million;
 - 6.3. the oily mixture does not originate from cargo pump-room bilges on oil tankers; and
 - 6.4. the oily mixture, in case of oil tankers, is not mixed with oil cargo residues.

D – General requirements

7. Whenever visible traces of oil are observed on or below the surface of the water in the immediate vicinity of a ship or its wake, Governments of Parties to the present Convention should, to the extent they are reasonably able to do so, promptly investigate the facts bearing on the issue of whether there has been a violation of the provisions of this regulation. The investigation should include, in particular, the wind and sea conditions, the track and speed of the ship, other possible sources of the visible traces in the vicinity, and any relevant oil discharge records.
8. No discharge into the sea shall contain chemicals or other substances in quantities or concentrations which are hazardous to the marine environment or chemicals or other substances introduced for the purpose of circumventing the conditions of discharge specified in this regulation.
9. The oil residues which cannot be discharged into the sea in compliance with this regulation shall be retained on board for subsequent discharge to reception facilities.

S Regulation 16 – Segregation of oil and water ballast and carriage of oil in forepeak tanks

1. Except as provided in paragraph 2 of this regulation, in ships delivered after 31 December 1979, as defined in regulation 1.28.2, of 4,000 gross tonnage and above other than oil tankers, and in oil tankers delivered after 31 December 1979, as defined in regulation 1.28.2, of 150 gross tonnage and above, no ballast water shall be carried in any oil fuel tank.
2. Where the need to carry large quantities of oil fuel render it necessary to carry ballast water which is not a clean ballast in any oil fuel tank, such ballast water shall be discharged to reception facilities or into the sea in compliance with regulation 15 of this Chapter using the equipment

specified in regulation 14.2 of this Chapter, and an entry shall be made in the Oil Record Book to this effect.

3. In a ship of 400 gross tonnage and above, for which the building contract is placed after 1 January 1982 or, in the absence of a building contract, the keel of which is laid or which is at a similar stage of construction after 1 July 1982, oil shall not be carried in a forepeak tank or a tank forward of the collision bulkhead.
4. All ships other than those subject to paragraphs 1 and 3 of this regulation shall comply with the provisions of those paragraphs as far as is reasonable and practicable.

S Regulation 17 – Oil Record Book, Part I (Machinery space operations)

1. Every oil tanker of 150 gross tonnage and above and every ship of 400 gross tonnage and above other than an oil tanker shall be provided with an Oil Record Book Part I (Machinery space operations). The Oil Record Book, whether as a part of the ship's official log-book or otherwise, shall be in the form specified in appendix III to this Chapter.⁶ *The record books shall be kept in accordance with the instructions provided in the record books.*
2. The Oil Record Book Part I shall be completed on each occasion, on a tank-to-tank basis if appropriate, whenever any of the following machinery space operations takes place in the ship:
 - 2.1. ballasting or cleaning of oil fuel tanks;
 - 2.2. discharge of dirty ballast or cleaning water from oil fuel tanks;
 - 2.3. collection and disposal of oil residues (sludge);
 - 2.4. discharge overboard or disposal otherwise of bilge water which has accumulated in machinery spaces; and
 - 2.5. bunkering of fuel or bulk lubricating oil.
3. In the event of such discharge of oil or oily mixture as is referred to in regulation 4 of this Chapter or in the event of accidental or other exceptional discharge of oil not excepted by that regulation, a statement shall be made in the Oil Record Book Part I of the circumstances of, and the reasons for, the discharge.
4. Each operation described in paragraph 2 of this regulation shall be fully recorded without delay in the Oil Record Book Part I, so that all entries in the book appropriate to that operation are completed. Each completed operation shall be signed by the officer or officers in charge of the operations concerned and each completed page shall be signed by the master of ship. The entries in the Oil Record Book Part I, for ships holding an International Oil Pollution Prevention Certificate, shall be at least in English, French or Spanish. Where entries in an official national language of the State whose flag the ship is entitled to fly are also used, this shall prevail in case of a dispute or discrepancy.
5. Any failure of the oil filtering equipment shall be recorded in the Oil Record Book Part I.
6. The Oil Record Book Part I shall be kept in such a place as to be readily available for inspection at all reasonable times and, except in the case of unmanned ships under tow, shall be kept on board the ship. It shall be preserved for a period of three years after the last entry has been made.
7. The competent authority of the Government of a Party to the present Convention may inspect the Oil Record Book Part I on board any ship to which this Chapter applies while the ship is in its port or offshore terminals and may make a copy of any entry in that book and may require the master of the ship to certify that the copy is a true copy of such entry. Any copy so made which has been

⁶ Refer to appendix III in MARPOL Annex I.

certified by the master of the ship as a true copy of an entry in the ship's Oil Record Book Part I shall be made admissible in any judicial proceedings as evidence of the facts stated in the entry. The inspection of an Oil Record Book Part I and the taking of a certified copy by the competent authority under this paragraph shall be performed as expeditiously as possible without causing the ship to be unduly delayed.

8. *The Oil Record Book shall be kept in legible writing and pages may not be torn out. Entries that have been made, may not be erased, crossed out or made illegible in any other way. Should it be necessary to make alterations in the record book, they shall be in the form of remarks.*

Part IV – Requirements for the cargo area of oil tankers

Part A – Construction

S Regulation 18 – Segregated Ballast tanks

Oil tankers of 20,000 tonnes deadweight and above delivered after 1 June 1982

1. Every crude oil tanker of 20,000 tonnes deadweight and above and every product carrier of 30,000 tonnes deadweight and above delivered after 1 June 1982, as defined in regulation 1.28.4, shall be provided with segregated ballast tanks and shall comply with paragraphs 2, 3 and 4, or 5 as appropriate, of this regulation.
2. The capacity of the segregated ballast tanks shall be so determined that the ship may operate safely on ballast voyages without recourse to the use of cargo tanks for water ballast except as provided for in paragraph 3 or 4 of this regulation. In all cases, however, the capacity of segregated ballast tanks shall be at least such that, in any ballast condition at any part of the voyage, including the conditions consisting of lightweight plus segregated ballast only, the ship's draughts and trim can meet the following requirements:
 - 2.1. the moulded draught amidships (d_m) in metres (without taking into account any ship's deformation) shall not be less than:
$$d_m = 2.0 + 0.02L$$
 - 2.2. the draughts at the forward and after perpendiculars shall correspond to those determined by the draught amidships (d_m) as specified in paragraph 2.1 of this regulation, in association with the trim by the stern of not greater than 0.015L; and
 - 2.3. in any case the draught at the after perpendicular shall not be less than that which is necessary to obtain full immersion of the propeller(s).
3. In no case shall ballast water be carried in cargo tanks, except:
 - 3.1. on those rare voyages when weather conditions are so severe that, in the opinion of the master, it is necessary to carry additional ballast water in cargo tanks for the safety of the ship; and
 - 3.2. in exceptional cases where the particular character of the operation of an oil tanker renders it necessary to carry ballast water in excess of the quantity required under paragraph 2 of this regulation, provided that such operation of the oil tanker falls under the category of exceptional cases as established by the Organization.
Such additional ballast water shall be processed and discharged in compliance with regulation 34 of this Chapter and an entry shall be made in the Oil Record Book Part II referred to in regulation 36 of this Chapter.

4. In the case of crude oil tankers, the additional ballast permitted in paragraph 3 of this regulation shall be carried in cargo tanks only if such tanks have been crude oil washed in accordance with regulation 35 of this Chapter before departure from an oil unloading port or terminal.
5. Notwithstanding the provisions of paragraph 2 of this regulation, the segregated ballast conditions for oil tankers less than 150 metres in length shall be to the satisfaction of the Administration.

Crude oil tankers of 40,000 tonnes deadweight and above delivered on or before 1 June 1982

6. Subject to the provisions of paragraph 7 of this regulation, every crude oil tanker of 40,000 tonnes deadweight and above delivered on or before 1 June 1982, as defined in regulation 1.28.3, shall be provided with segregated ballast tanks and shall comply with the requirements of paragraphs 2 and 3 of this regulation.
7. Crude oil tankers referred to in paragraph 6 of this regulation may, in lieu of being provided with segregated tanks, operate with a cargo tank cleaning procedure using crude oil washing in accordance with regulation 33 and 35 of this Chapter unless the crude oil tanker is intended to carry crude oil which is not suitable for crude oil washing.

Product carriers of 40,000 tonnes deadweight and above delivered on or before 1 June 1982

8. Every product carrier of 40,000 tonnes deadweight and above delivered on or before 1 June 1982, as defined in regulation 1.28.3, shall be provided with segregated ballast tanks and shall comply with the requirements of paragraphs 2 and 3 of this regulation, or alternatively operate with dedicated clean ballast tanks in accordance with the following provisions:
 - 8.1. The product carrier shall have adequate tank capacity, dedicated solely to the carriage of clean ballast as defined in regulation 1.17 of this Chapter, to meet the requirements of paragraphs 2 and 3 of this regulation.
 - 8.2. The arrangements and operational procedures for dedicated clean ballast tanks shall comply with the requirements established by the Administration. Such requirements shall contain at least all the provisions of the revised Specifications for Oil Tankers with Dedicated Clean Ballast Tanks adopted by the Organization by resolution A.495(XII).
 - 8.3. The product carrier shall be equipped with an oil content meter, approved by the Administration on the basis of specifications recommended by the Organization, to enable supervision of the oil content in ballast water being discharged.⁷
 - 8.4. Every product carrier operating with dedicated clean ballast tanks shall be provided with a Dedicated Clean Ballast Tank Operation Manual⁸ detailing the system and specifying operational procedures. Such a Manual shall be to the satisfaction of the Administration and shall contain all the information set out in the Specifications referred to in subparagraph 8.2 of this regulation. If an alteration affecting the dedicated clean ballast tank system is made, the Operation Manual shall be revised accordingly.

⁷ For oil content meters installed on oil tankers built prior to 2 October 1986, refer to the Recommendation on international performance and test specifications for oily-water separating equipment and oil content meters adopted by the Organization by resolution A.393(X). For oil content meters as part of discharge monitoring and control systems installed on oil tankers built on or after 2 October 1986, refer to the Guidelines and specifications for oil discharge monitoring and control systems for oil tankers adopted by the Organization by resolution A.586(14). For oil content meters installed on oil tankers the keels of which are laid, or which are at a similar stage of construction, on or after 1 January 2005, refer to the Revised Guidelines and specifications adopted by the Organization by resolution MEPC.108(49).

⁸ See resolution A.495(XII) for the standard format of the Manual.

An oil tanker qualified as a segregated ballast oil tanker

9. Any oil tanker which is not required to be provided with segregated ballast tanks in accordance with paragraphs 1, 6 or 8 of this regulation may, however, be qualified as a segregated ballast tanker, provided that it complies with the requirements of paragraphs 2 and 3 or 5, as appropriate, of this regulation.

Oil tankers delivered on or before 1 June 1982 having special ballast arrangements

10. Oil tankers delivered on or before 1 June 1982, as defined in regulation 1.28.3, having special ballast arrangements:
- 10.1. Where an oil tanker delivered on or before 1 June 1982, as defined in regulation 1.28.3, is so constructed or operates in such a manner that it complies at all times with the draught and trim requirements set out in paragraph 2 of this regulation without recourse to the use of ballast water, it shall be deemed to comply with the segregated ballast tank requirements referred to in paragraph 6 of this regulation, provided that all of the following conditions are complied with:
- 10.1.1. operational procedures and ballast arrangements are approved by the Administration;
- 10.1.2. agreement is reached between the Administration and the Governments of the port States Parties to the present Convention concerned when the draught and trim requirements are achieved through an operational procedure; and
- 10.1.3. the International Oil Pollution Prevention Certificate is endorsed to the effect that the oil tanker is operating with special ballast arrangements.
- 10.2. In no case shall ballast water be carried in oil tanks except on those rare voyages when weather conditions are so severe that, in the opinion of the master, it is necessary to carry additional ballast water in cargo tanks for the safety of the ship. Such additional ballast water shall be processed and discharged in compliance with regulation 34 of this Chapter and in accordance with the requirements of regulations 29, 31 and 32 of this Chapter, and an entry shall be made in the Oil Record Book referred to in regulation 36 of this Chapter.
- 10.3. An Administration which has endorsed a Certificate in accordance with subparagraph 10.1.3 of this regulation shall communicate to the Organization the particulars thereof for circulation to the Parties to the present Convention.

Oil tankers of 70,000 tonnes deadweight and above delivered after 31 December 1979

11. Oil tankers of 70,000 tonnes deadweight and above delivered after 31 December 1979, as defined in regulation 1.28.2, shall be provided with segregated ballast tanks and shall comply with paragraphs 2, 3 and 4 or paragraph 5 as appropriate of this regulation.

Protective location of segregated ballast

12. In every crude oil tanker of 20,000 tonnes deadweight and above and every product carrier of 30,000 tonnes deadweight and above delivered after 1 June 1982, as defined in regulation 1.28.4, except those tankers that meet regulation 19, the segregated ballast tanks required to provide the capacity to comply with the requirements of paragraph 2 of this regulation, which are located within the cargo tank length, shall be arranged in accordance with the requirements of paragraphs 13, 14 and 15 of this regulation to provide a measure of protection against oil outflow in the event of grounding or collision.

13. Segregated ballast tanks and spaces other than oil tanks within the cargo tanks length (L_t) shall be so arranged as to comply with the following requirement:

$$\sum PA_c + \sum PA_s \geq J[L_t(B + 2D)]$$

where:

- PA_c = the side shell area in square metres for each segregated ballast tank or space other than an oil tank based on projected moulded dimensions,
 PA_s = the bottom shell area in square metres for each such tank or space based on projected moulded dimensions,
 L_t = length in metres between the forward and after extremities of the cargo tanks,
 B = maximum breadth of the ship in metres as defined in regulation 1.22 of this Chapter,
 D = moulded depth in metres measured vertically from the top of the keel to the top of the freeboard deck beam at side amidships. In ships having rounded gunwales, the moulded depth shall be measured to the point of intersection of the moulded lines of the deck and side shell plating, the lines extending as though the gunwale were of angular design,
 J = 0.45 for oil tankers of 20,000 tonnes deadweight, 0.30 for oil tankers of 200,000 tonnes deadweight and above, subject to the provisions of paragraph 14 of this regulation. For intermediate values of deadweight the value of “J” shall be determined by linear interpolation.

Whenever symbols given in this paragraph appear in this regulation, they have the meaning as defined in this paragraph.

14. For tankers of 200,000 tonnes deadweight and above the value of “J” may be reduced as follows:

$$J_{\text{reduced}} = \left(J - \left(a - \frac{O_c + O_s}{4 O_A} \right) \right) \text{ or } 0.2 \text{ whichever is greater}$$

where:

- a = 0.25 for oil tankers of 200,000 tonnes deadweight,
 a = 0.40 for oil tankers of 300,000 tonnes deadweight,
 a = 0.50 for oil tankers of 420,000 tonnes deadweight and above.
For intermediate values of deadweight the value of ‘a’ shall be determined by linear interpolation.
 O_c = as defined in regulation 25.1.1 of this Chapter,
 O_s = as defined in regulation 25.1.2 of this Chapter,
 O_A = the allowable oil outflow as required by regulation 26.2 of this Chapter.

15. In the determination of PA_c and PA_s for segregated ballast tanks and spaces other than oil tanks the following shall apply:

- 15.1. the minimum width of each wing tank or space either of which extends for the full depth of the ship’s side or from the deck to the top of the double bottom shall be not less than 2 m. The width shall be measured inboard from the ship’s side at right angles to the centreline. Where a

lesser width is provided, the wing tank or space shall not be taken into account when calculating the protecting area PA_c ; and

- 15.2. the minimum vertical depth of each double bottom tank or space shall be $B/15$ or 2 m, whichever is the lesser. Where a lesser depth is provided, the bottom tank or space shall not be taken into account when calculating the protecting area PA_s .

The minimum width and depth of wing tanks and double bottom tanks shall be measured clear of the bilge area and, in the case of minimum width, shall be measured clear of any rounded gunwale area.

S Regulation 19 – Double hull and double bottom requirements for oil tankers delivered on or after 6 July 1996

1. This regulation shall apply to oil tankers of 600 tonnes deadweight and above delivered on or after 6 July 1996, as defined in regulation 1.28.6, as follows:
2. Every oil tanker of 5000 tonnes deadweight and above shall:
 - 2.1. in lieu of paragraphs 12 to 15 of regulation 18, as applicable, comply with the requirements of paragraph 3 of this regulation unless it is subject to the provisions of paragraphs 4 and 5 of this regulation; and
 - 2.2. comply, if applicable, with the requirements of regulation 28.6.
3. The entire cargo tank length shall be protected by ballast tanks or spaces other than tanks that carry oil as follows:

3.1. Wing tanks or spaces

Wing tanks or spaces shall extend either for the full depth of the ship's side or from the top of the double bottom to the uppermost deck, disregarding a rounded gunwale where fitted. They shall be arranged such that the cargo tanks are located inboard of the moulded line of the side shell plating nowhere less than the distance w , which, as shown in figure 1, is measured at any cross-section at right angles to the side shell, as specified below:

$$w = 0,5 + \frac{DW}{20.000} \text{ metres or}$$

$w = 2.0$ m, whichever is the lesser.

The minimum value of $w = 1.0$ m.

3.2. Double bottom tanks or spaces

At any cross-section, the depth of each double bottom tank or space shall be such that the distance 'h' between the bottom of the cargo tanks and the moulded line of the bottom shell plating measured at right angles to the bottom shell plating as shown in figure 1 is not less than specified below:

$h = B/15$ (m) or

$h = 2.0$ m, whichever is the lesser.

The minimum value of $h = 1.0$ m.

- 3.3. Turn of the bilge area or at locations without a clearly defined turn of the bilge When the distances h and w are different, the distance w shall have preference at levels exceeding $1.5h$ above the baseline as shown in figure 1.

ρ_s = density of seawater in kg/m³
 p = maximum set pressure above atmospheric pressure (gauge pressure) of pressure/vacuum valve provided for the cargo tank in pascals
 f = safety factor = 1.1
 g = standard acceleration of gravity (9.81 m/s²).

- 4.2. Any horizontal partition necessary to fulfil the above requirements shall be located at a height not less than $B/6$ or 6 m, whichever is the lesser, but not more than $0.6D$, above the baseline where D is the moulded depth amidships.
- 4.3. The location of wing tanks or spaces shall be as defined in paragraph 3.1 of this regulation except that, below a level $1.5h$ above the baseline where h is as defined in paragraph 3.2 of this regulation, the cargo tank boundary line may be vertical down to the bottom plating, as shown in figure 2.

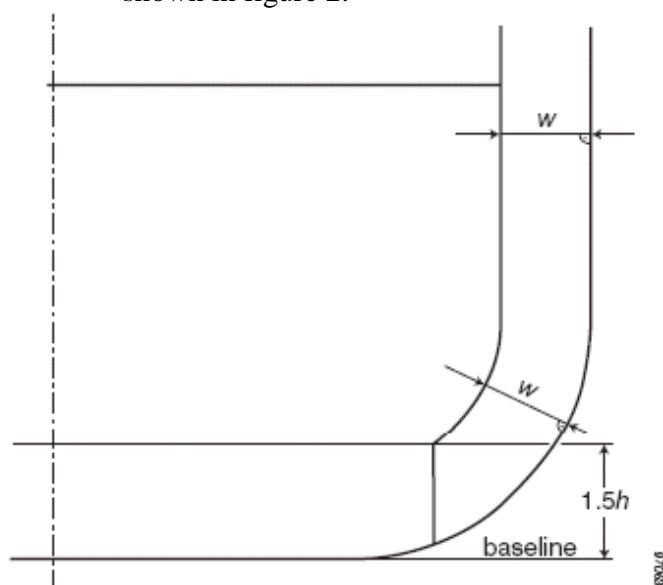

Figure 2 – Cargo tank boundary lines for the purpose of paragraph 4

5. Other methods of design and construction of oil tankers may also be accepted as alternatives to the requirements prescribed in paragraph 3 of this regulation, provided that such methods ensure at least the same level of protection against oil pollution in the event of collision or stranding and are approved in principle by the Marine Environment Protection Committee based on guidelines developed by the Organization.⁹
6. Every oil tanker of less than 5,000 tonnes deadweight shall comply with paragraphs 3 and 4 of this regulation, or shall:
 - 6.1. at least be fitted with double bottom tanks or spaces having such a depth that the distance 'h' specified in paragraph 3.2 of this regulation complies with the following:
 $h = B/15$ (m)

⁹ Refer to the Revised Interim Guidelines for the approval of alternative methods of design and construction of oil tankers adopted by the Marine Environment Protection Committee of the Organization by resolution MEPC.110(49).

with a minimum value of $h = 0.76$ m;

In the turn of the bilge area and at locations without a clearly defined turn of the bilge, the cargo tank boundary line shall run parallel to the line of the midship flat bottom as shown in figure 3; and

- 6.2. be provided with cargo tanks so arranged that the capacity of each cargo tank does not exceed 700 m^3 unless wing tanks or spaces are arranged in accordance with paragraph 3.1 of this regulation, complying with the following:

$$w = 0.4 + \frac{2.4 DW}{20,000} \text{ (meter)}$$

with a minimum value of $w = 0.76$

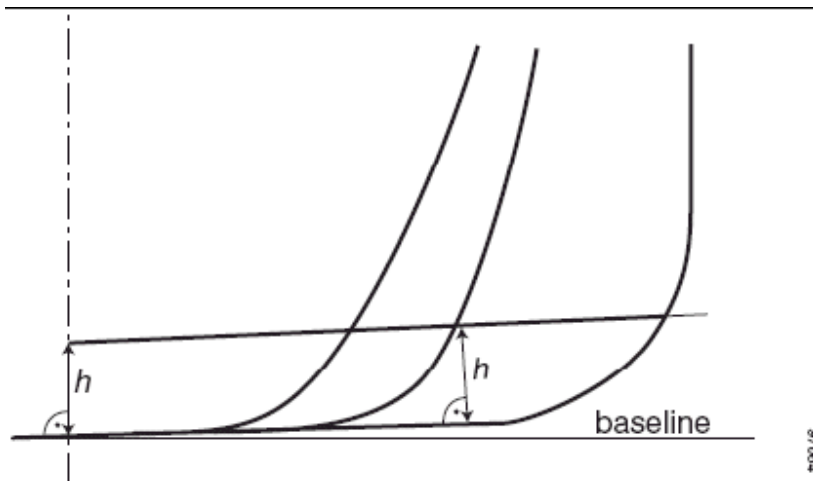

Figure 3 Cargo tank boundary lines for the purpose of paragraph 6

7. Oil shall not be carried in any space extending forward of a collision bulkhead located in accordance with regulation II-1/11 of the International Convention for the Safety of Life at Sea, 1974, as amended. An oil tanker that is not required to have a collision bulkhead in accordance with that regulation shall not carry oil in any space extending forward of the transverse plane perpendicular to the centreline that is located as if it were a collision bulkhead located in accordance with that regulation.
8. In approving the design and construction of oil tankers to be built in accordance with the provisions of this regulation, Administrations shall have due regard to the general safety aspects, including the need for the maintenance and inspections of wing and double bottom tanks or spaces.

S Regulation 20 – Double hull and double bottom requirements for oil tankers delivered before 6 July 1996

1. Unless expressly provided otherwise this regulation shall:
 - 1.1. apply to oil tankers of 5,000 tonnes deadweight and above, which are delivered before 6 July 1996, as defined in regulation 1.28.5 of this Chapter; and
 - 1.2. not apply to oil tankers complying with regulation 19 and regulation 28 in respect of paragraph 28.6, which are delivered before 6 July 1996, as defined in regulation 1.28.5 of this Chapter; and
 - 1.3. not apply to oil tankers covered by subparagraph 1 above which comply with regulation 19.3.1 and 19.3.2 or 19.4 or 19.5 of this Chapter, except that the requirement for minimum distances between the cargo tank boundaries and the ship side and bottom plating need not be met in all respects. In that event, the side protection distances shall not be less than those specified in the International Bulk Chemical Code for type 2 cargo tank location and the bottom protection distances at centreline shall comply with regulation 18.15.2 of this Chapter.
2. For the purpose of this regulation:
 - 2.1. “Heavy diesel oil” means diesel oil other than those distillates of which more than 50 per cent by volume distils at a temperature not exceeding 340°C when tested by the method acceptable to the Organization.¹⁰
 - 2.2. “Fuel oil” means heavy distillates or residues from crude oil or blends of such materials intended for use as a fuel for the production of heat or power of a quality equivalent to the specification acceptable to the Organization.¹¹
3. For the purpose of this regulation, oil tankers are divided into the following categories:
 - 3.1. “Category 1 oil tanker” means an oil tanker of 20,000 tonnes deadweight and above carrying crude oil, fuel oil, heavy diesel oil or lubricating oil as cargo, and of 30,000 tonnes deadweight and above carrying oil other than the above, which does not comply with the requirements for oil tankers delivered after 1 June 1982, as defined in regulation 1.28.4 of this Chapter;
 - 3.2. “Category 2 oil tanker” means an oil tanker of 20,000 tonnes deadweight and above carrying crude oil, fuel oil, heavy diesel oil or lubricating oil as cargo, and of 30,000 tonnes deadweight and above carrying oil other than the above, which complies with the requirements for oil tankers delivered after 1 June 1982, as defined in regulation 1.28.4 of this Chapter; and
 - 3.3. “Category 3 oil tanker” means an oil tanker of 5,000 tonnes deadweight and above but less than that specified in subparagraph 1 or 2 of this paragraph.
4. An oil tanker to which this regulation applies shall comply with the requirements of paragraphs 2 to 5, 7 and 8 of regulation 19 and regulation 28 in respect of paragraph 28.6 of this Chapter not later than 5 April 2005 or the anniversary of the date of delivery of the ship on the date or in the year specified in the following table:

¹⁰ Refer to the American Society for Testing and Materials' Standard Test Method (Designation D86).

¹¹ Refer to the American Society for Testing and Materials' Specification for Number Four Fuel Oil (Designation D396) or heavier.

Category of oil tanker	Date or year
Category 1	5 April 2005 for ships delivered on 5 April 1982 or earlier 2005 for ships delivered after 5 April 1982
Category 2 and Category 3	5 April 2005 for ships delivered on 5 April 1977 or earlier 2005 for ships delivered after 5 April 1977 but before 1 January 1978 2006 for ships delivered in 1978 and 1979 2007 for ships delivered in 1980 and 1981 2008 for ships delivered in 1982 2009 for ships delivered in 1983 2010 for ships delivered in 1984 or later

5. Notwithstanding the provisions of paragraph 4 of this regulation, in the case of a Category 2 or 3 oil tanker fitted with only double bottoms or double sides not used for the carriage of oil and extending to the entire cargo tank length or double hull spaces which are not used for the carriage of oil and extend to the entire cargo tank length, but which does not fulfil conditions for being exempted from the provisions of paragraph 1.3 of this regulation, the Administration may allow continued operation of such a ship beyond the date specified in paragraph 4 of this regulation, provided that:
 - 5.1. the ship was in service on 1 July 2001;
 - 5.2. the Administration is satisfied by verification of the official records that the ship complied with the conditions specified above;
 - 5.3. the conditions of the ship specified above remain unchanged; and
 - 5.4. such continued operation does not go beyond the date on which the ship reaches 25 years after the date of its delivery.
6. A Category 2 or 3 oil tanker of 15 years and over after the date of its delivery shall comply with the Condition Assessment Scheme adopted by the Marine Environment Protection Committee by resolution MEPC.94(46), as amended, provided that such amendments shall be adopted, brought into force and take effect in accordance with the provisions of article 16 of the MARPOL Convention relating to amendment procedures applicable to an appendix to a chapter.
7. The Administration may allow continued operation of a Category 2 or 3 oil tanker beyond the date specified in paragraph 4 of this regulation, if satisfactory results of the Condition Assessment Scheme warrant that, in the opinion of the Administration, the ship is fit to continue such operation, provided that the operation shall not go beyond the anniversary of the date of delivery of the ship in 2015 or the date on which the ship reaches 25 years after the date of its delivery, whichever is the earlier date.
8.
 - 8.1. The Administration of a Party to the MARPOL Convention which allows the application of paragraph 5 of this regulation, or allows, suspends, withdraws or declines the application of paragraph 7 of this regulation, to a ship entitled to fly its flag shall forthwith communicate to the Organization for circulation to the Parties to the MARPOL Convention particulars thereof, for their information and appropriate action, if any.
 - 8.2. A Party to the MARPOL Convention shall be entitled to deny entry into the ports or offshore terminals under its jurisdiction of oil tankers operating in accordance with the provisions of:

8.2.1. paragraph 5 of this regulation beyond the anniversary of the date of delivery of the ship in 2015; or

8.2.2. paragraph 7 of this regulation.

In such cases, that Party shall communicate to the Organization for circulation to the Parties to the MARPOL Convention particulars thereof for their information.

S Regulation 21 – Prevention of oil pollution from oil tankers carrying heavy grade oil as cargo

1. This regulation shall:

1.1. apply to oil tankers of 600 tonnes deadweight and above carrying heavy grade oil as cargo regardless of the date of delivery; and

1.2. not apply to oil tankers covered by subparagraph 1 above which comply with regulations 19.3.1 and 19.3.2 or 19.4 or 19.5 of this Chapter, except that the requirement for minimum distances between the cargo tank boundaries and the ship side and bottom plating need not be met in all respects. In that event, the side protection distances shall not be less than those specified in the International Bulk Chemical Code for type 2 cargo tank location and the bottom protection distances at centreline shall comply with regulation 18.15.2 of this Chapter.

2. For the purpose of this regulation heavy grade oil means any of the following:

2.1. crude oils having a density at 15°C higher than 900 kg/m³;

2.2. fuel oils¹² having either a density at 15°C higher than 900 kg/m³ or a kinematic viscosity at 50°C higher than 180 mm²/s; or

2.3. bitumen, tar and their emulsions.

3. An oil tanker to which this regulation applies shall comply with the provisions of paragraphs 4 to 8 of this regulation in addition to complying with the applicable provisions of regulation 20.

4. Subject to the provisions of paragraphs 5, 6 and 7 of this regulation, an oil tanker to which this regulation applies shall:

4.1. if 5,000 tonnes deadweight and above, comply with the requirements of regulation 19 of this Chapter not later than 5 April 2005; or

4.2. if 600 tonnes deadweight and above, but below 5,000, be fitted with double-bottom tanks in accordance with the provisions of regulation 19.6.1 and wing tanks arranged in compliance with regulation 19.3.1 and complying with the requirement for distance *w* as referred to in regulation 19.6.2, not later than the anniversary of the date of delivery of the ship in the year 2008.

5. In the case of an oil tanker of 5,000 tonnes deadweight and above, carrying heavy grade oil as cargo fitted with only double bottoms or double sides not used for the carriage of oil and extending to the entire cargo tank length or double hull spaces which are not used for the carriage of oil and extend to the entire cargo tank length, but which does not fulfil conditions for being exempted from the provisions of paragraph 1.2 of this regulation, the Administration may allow continued operation of such a ship beyond the date specified in paragraph 4 of this regulation, provided that:

5.1. the ship was in service on 4 December 2003;

5.2. the Administration is satisfied by verification of the official records that the ship complied with the conditions specified above;

5.3. the conditions of the ship specified above remain unchanged; and

¹² MEPC.54 amended this definition by resolution MEPC.141(54) (see item 6 of the Additional information).

- 5.4. such continued operation does not go beyond the date on which the ship reaches 25 years after the date of its delivery.
6.
 - 6.1. The Administration may allow continued operation of an oil tanker of 5,000 tonnes deadweight and above, carrying crude oil having a density at 15°C higher than 900 kg/m³ but lower than 945 kg/m³, beyond the date specified in paragraph 4.1 of this regulation, if satisfactory results of the Condition Assessment Scheme referred to in regulation 20.6 warrant that, in the opinion of the Administration, the ship is fit to continue such operation, having regard to the size, age, operational area and structural conditions of the ship and provided that the operation shall not go beyond the date on which the ship reaches 25 years after the date of its delivery.
 - 6.2. The Administration may allow continued operation of an oil tanker of 600 tonnes deadweight and above but less than 5,000 tonnes deadweight, carrying heavy grade oil as cargo, beyond the date specified in paragraph 4.2 of this regulation, if, in the opinion of the Administration, the ship is fit to continue such operation, having regard to the size, age, operational area and structural conditions of the ship, provided that the operation shall not go beyond the date on which the ship reaches 25 years after the date of its delivery.
7. The Administration of a Party to the present Convention may exempt an oil tanker of 600 tonnes deadweight and above carrying heavy grade oil as cargo from the provisions of this regulation if the oil tanker:
 - 7.1. either is engaged in voyages exclusively within an area under its jurisdiction, or operates as a floating storage unit of heavy grade oil located within an area under its jurisdiction; or
 - 7.2. either is engaged in voyages exclusively within an area under the jurisdiction of another Party, or operates as a floating storage unit of heavy grade oil located within an area under the jurisdiction of another Party, provided that the Party within whose jurisdiction the oil tanker will be operating agrees to the operation of the oil tanker within an area under its jurisdiction.
8.
 - 8.1. The Administration of a Party to the MARPOL Convention which allows, suspends, withdraws or declines the application of paragraph 5, 6 or 7 of this regulation to a ship entitled to fly its flag shall forthwith communicate to the Organization for circulation to the Parties to the MARPOL Convention particulars thereof, for their information and appropriate action, if any.
 - 8.2. Subject to the provisions of international law, a Party to the present Convention shall be entitled to deny entry of oil tankers operating in accordance with the provisions of paragraph 5 or 6 of this regulation into the ports or offshore terminals under its jurisdiction, or deny ship-to-ship transfer of heavy grade oil in areas under its jurisdiction except when this is necessary for the purpose of securing the safety of a ship or saving life at sea. In such cases, that Party shall communicate to the Organization for circulation to the Parties to the present Convention particulars thereof for their information.

S Regulation 22 – Pump-room bottom protection

1. This regulation applies to oil tankers of 5,000 tonnes deadweight and above constructed on or after 1 January 2007.

2. The pump-room shall be provided with a double bottom such that at any cross-section the depth of each double bottom tank or space shall be such that the distance 'h' between the bottom of the pump-room and the ship's baseline measured at right angles to the ship's baseline is not less than specified below:
 $h = B/15$ (m) or
 $h = 2$ m, whichever is the lesser.
 The minimum value of $h = 1$ m.
3. In case of pump-rooms whose bottom plate is located above the baseline by at least the minimum height required in paragraph 2 above (e.g. gondola stern designs), there will be no need for a double bottom construction in way of the pump-room.
4. Ballast pumps shall be provided with suitable arrangements to ensure efficient suction from double bottom tanks.
5. Notwithstanding the provisions of paragraphs 2 and 3 above, where the flooding of the pump-room would not render the ballast or cargo pumping system inoperative, a double bottom need not be fitted.

S Regulation 23 – Accidental oil outflow performance

(Oil tankers delivered on or after 1 January 2010)

1. This regulation shall apply to oil tankers delivered on or after 1 January 2010, as defined in regulation 1.28.8.
2. For the purpose of this regulation, the following definitions shall apply:
 - 2.1. "Load line draught (d_s)" is the vertical distance, in metres, from the moulded baseline at mid-length to the waterline corresponding to the summer freeboard to be assigned to the ship. Calculations pertaining to this regulation should be based on draught d_s , notwithstanding assigned draughts that may exceed d_s , such as the tropical load line.
 - 2.2. "Waterline (d_B)" is the vertical distance, in metres, from the moulded baseline at mid-length to the waterline corresponding to 30% of the depth D_S .
 - 2.3. "Breadth (B_S)" is the greatest moulded breadth of the ship, in metres, at or below the deepest load line draught d_s .
 - 2.4. "Breadth (B_B)" is the greatest moulded breadth of the ship, in metres, at or below the waterline d_B .
 - 2.5. "Depth (D_S)" is the moulded depth, in metres, measured at mid-length to the upper deck at side.
 - 2.6. "Length (L) and deadweight (D_W)" are as defined in regulations 1.19 and 1.23, respectively.
3. To provide adequate protection against oil pollution in the event of collision or stranding, the following shall be complied with:
 - 3.1. for oil tankers of 5,000 tonnes deadweight (DWT) and above, the mean oil outflow parameter shall be as follows:

$O_M \leq 0.015$	for $C \leq 200,000 \text{ m}^3$
$O_M \leq 0.012 + (0.003/200,000)(400,000 - C)$	for $200,000 \text{ m}^3 < C < 400,000 \text{ m}^3$
$O_M \leq 0.012$	for $C \geq 400,000 \text{ m}^3$

For combination carriers between 5,000 tonnes deadweight (DWT) and 200,000 m^3 capacity, the mean oil outflow parameter may be applied, provided calculations are submitted to the satisfaction of the Administration, demonstrating that, after accounting for its increased

structural strength, the combination carrier has at least equivalent oil outflow performance to a standard double hull tanker of the same size having a $O_M \leq 0.015$.

$$O_M \leq 0.021 \quad \text{for } C \leq 100,000 \text{ m}^3$$

$$O_M \leq 0.015 + (0.006/100,000)(200,000 - C) \quad \text{for } 100,000 \text{ m}^3 < C \leq 200,000 \text{ m}^3$$

where:

O_M = mean oil outflow parameter

C = total volume of cargo oil, in m^3 , at 98% tank filling.

- 3.2. For oil tankers of less than 5,000 tonnes deadweight (DWT): The length of each cargo tank shall not exceed 10 m or one of the following values, whichever is the greater:
 - 3.2.1. where no longitudinal bulkhead is provided inside the cargo tanks:
 $(0.5 b_i/B + 0.1)L$ but not to exceed $0.2L$
 - 3.2.2. where a centreline longitudinal bulkhead is provided inside the cargo tanks:
 $(0.25 b_i/B + 0.15)L$
 - 3.2.3. where two or more longitudinal bulkheads are provided inside the cargo tanks:
 - 3.2.3.1. for wing cargo tanks: $0.2L$
 - 3.2.3.2. for centre cargo tanks:
 - 3.2.3.2.1. if $b_i/B \geq 0,2$: $0.2L$
 - 3.2.3.2.2. if $b_i/B < 0,2$:
 - where no centreline longitudinal bulkhead is provided: $(0.5 b_i/B + 0.1)L$
 - where a centreline longitudinal bulkhead is provided: $(0.25 b_i/B + 0.15)L$
 - 3.2.4. b_i is the minimum distance from the ship's side to the outer longitudinal bulkhead of the tank in question measured inboard at right angles to the centreline at the level corresponding to the assigned summer freeboard.
4. The following general assumptions shall apply when calculating the mean oil outflow parameter:
 - 4.1. The cargo block length extends between the forward and aft extremities of all tanks arranged for the carriage of cargo oil, including slop tanks.
 - 4.2. Where this regulation refers to cargo tanks, it shall be understood to include all cargo tanks, slop tanks and fuel tanks located within the cargo block length.
 - 4.3. The ship shall be assumed loaded to the load line draught d_s without trim or heel.
 - 4.4. All cargo oil tanks shall be assumed loaded to 98% of their volumetric capacity. The nominal density of the cargo oil (ρ_n) shall be calculated as follows:

$$\rho_n = 1000(DWT)/C \text{ (kg/m}^3\text{)}$$
 - 4.5. For the purposes of these outflow calculations, the permeability of each space within the cargo block, including cargo tanks, ballast tanks and other non-oil spaces, shall be taken as 0.99, unless proven otherwise.
 - 4.6. Suction wells may be neglected in the determination of tank location provided that such wells are as small as practicable and the distance between the well bottom and bottom shell plating is not less than $0.5h$, where h is the height as defined in regulation 19.3.2.
5. The following assumptions shall be used when combining the oil outflow parameters:
 - 5.1. The mean oil outflow shall be calculated independently for side damage and for bottom damage and then combined into the non-dimensional oil outflow parameter O_M , as follows:

$$O_M = (0.4O_{MS} + 0.6O_{MB})/C$$

where:

O_{MS} = mean outflow for side damage, in m^3 ; and

O_{MB} = mean outflow for bottom damage, in m^3 .

- 5.2. For bottom damage, independent calculations for mean outflow shall be done for 0 m and minus 2.5 m tide conditions, and then combined as follows:

$$O_{MB} = 0.7 O_{MB(0)} + 0.3 O_{MB(2.5)}$$

where:

$O_{MB(0)}$ = mean outflow for 0 m tide condition; and

$O_{MB(2.5)}$ = mean outflow for minus 2.5 m tide condition, in m^3 .

6. The mean outflow for side damage O_{MS} shall be calculated as follows:

$$O_{MS} = C_3 \sum_i^n P_{S(i)} O_{S(i)} \quad (m^3)$$

where:

i = represents each cargo tank under consideration;

n = total number of cargo tanks;

$P_{S(i)}$ = the probability of penetrating cargo tank i from side damage, calculated in accordance with paragraph 8.1 of this regulation;

$O_{S(i)}$ = the outflow, in m^3 , from side damage to cargo tank i , which is assumed equal to the total volume in cargo tank (i) at 98% filling, unless it is proven through the application of the Guidelines referred to in regulation 19.5 that any significant cargo volume will be retained; and

C_3 = 0.77 for ships having two longitudinal bulkheads inside the cargo tanks, provided these bulkheads are continuous over the cargo block and $P_{S(i)}$ is developed in accordance with this regulation. C_3 equals 1.0 for all other ships or when $P_{S(i)}$ is developed in accordance with paragraph 10 of this regulation.

7. The mean outflow for bottom damage shall be calculated for each tidal condition as follows:

$$7.1. \quad O_{MB(0)} = \sum_i^n P_{B(i)} O_{B(i)} C_{DB(i)} \quad (m^3)$$

where:

i = represents each cargo tank under consideration;

n = the total number of cargo tanks;

$P_{B(i)}$ = the probability of penetrating cargo tank i from bottom damage, calculated in accordance with paragraph 9.1 of this regulation;

$O_{B(i)}$ = the outflow from cargo tank i , in m^3 , calculated in accordance with paragraph 7.3 of this regulation; and

$C_{DB(i)}$ = factor to account for oil capture as defined in paragraph 7.4 of this regulation

$$7.2. \quad O_{MB(2.5)} = \sum_i^n P_{B(i)} O_{B(i)} C_{DB(i)} \quad (m^3)$$

where:

i , n , $P_{B(i)}$ and $C_{DB(i)}$ = as defined in subparagraph .1 above;

$O_{B(i)}$ = the outflow from cargo tank i , in m^3 , after tidal change.

7.3. The oil outflow $O_{B(i)}$ for each cargo oil tank shall be calculated based on pressure-balance principles, in accordance with the following assumptions:

7.3.1. The ship shall be assumed stranded with zero trim and heel, with the stranded draught prior to tidal change equal to the load line draught d_s .

7.3.2. The cargo level after damage shall be calculated as follows:

$$h_c = \{(d_s + t_c - Z_l) (\rho_s) - (1000 p) / g\} / \rho$$

where:

h_c = the height of the cargo oil above Z_l , in metres;

t_c = the tidal change, in metres. Reductions in tide shall be expressed as negative values;

Z_l = the height of the lowest point in the cargo tank above baseline, in metres;

ρ_s = density of seawater, to be taken as 1025 kg/m^3 ;

p = if an inert gas system is fitted, the normal overpressure, in kilopascals, to be taken as not less than 5 kPa; if an inert gas system is not fitted, the overpressure may be taken as 0;

g = the acceleration of gravity, to be taken as 9.81 m/s^2 ; and

ρ_n = nominal density of cargo oil, calculated in accordance with paragraph 4.4 of this regulation.

7.3.3. For cargo tanks bounded by the bottom shell, unless proven otherwise, oil outflow $O_{B(i)}$ shall be taken not less than 1% of the total volume of cargo oil loaded in cargo tank i , to account for initial exchange losses and dynamic effects due to current and waves.

7.4. In the case of bottom damage, a portion from the outflow from a cargo tank may be captured by non-oil compartments. This effect is approximated by application of the factor $C_{DB(i)}$ for each tank, which shall be taken as follows:

$C_{DB(i)} = 0.6$ for cargo tanks bounded from below by non-oil compartments;

$C_{DB(i)} = 1.0$ for cargo tanks bounded by the bottom shell.

8. The probability P_S of breaching a compartment from side damage shall be calculated as follows:

8.1. $P_S = P_{SL} P_{SV} P_{ST}$

where:

$P_{SL} = 1 - P_{Sf} - P_{Sa}$ = probability the damage will extend into the longitudinal zone bounded by X_a and X_f ;

$P_{SV} = 1 - P_{Su} - P_{Sl}$ = probability the damage will extend into the vertical zone bounded by Z_l and Z_u ; and

$P_{ST} = 1 - P_{Sy}$ = probability the damage will extend transversely beyond the boundary defined by y .

8.2. P_{Sa} , P_{Sf} , P_{Sl} , P_{Su} and P_{Sy} shall be determined by linear interpolation from the tables of probabilities for side damage provided in paragraph 8.3 of this regulation,

where:

P_{Sa} = the probability the damage will lie entirely aft of location X_a/L ;

P_{Sf} = the probability the damage will lie entirely forward of location X_f/L ;

P_{Sl} = the probability the damage will lie entirely below the tank;

P_{Su} = the probability the damage will lie entirely above the tank; and

P_{Sy} = the probability the damage will lie entirely outboard of the tank.

Compartment boundaries X_a , X_f , Z_l , Z_u and y shall be developed as follows:

- X_a = the longitudinal distance from the aft terminal of L to the aftmost point on the compartment being considered, in metres;
- X_f = the longitudinal distance from the aft terminal of L to the foremost point on the compartment being considered, in metres;
- Z_l = the vertical distance from the moulded baseline to the lowest point on the compartment being considered, in metres;
- Z_u = the vertical distance from the moulded baseline to the highest point on the compartment being considered, in metres. Z_u is not to be taken greater than DS ; and
- y = the minimum horizontal distance measured at right angles to the centreline between the compartment under consideration and the side shell, in metres;¹³

8.3. Tables of probabilities for side damage

X_a/L	P_{sa}	X_f/L	P_{sf}	Z_l/D_s	P_{sl}	Z_u/D_s	P_{su}
0.00	0.000	0.00	0.967	0.00	0.000	0.00	0.968
0.05	0.023	0.05	0.917	0.05	0.000	0.05	0.952
0.10	0.068	0.10	0.867	0.10	0.001	0.10	0.931
0.15	0.117	0.15	0.817	0.15	0.003	0.15	0.905
0.20	0.167	0.20	0.767	0.20	0.007	0.20	0.873
0.25	0.217	0.25	0.717	0.25	0.013	0.25	0.836
0.30	0.267	0.30	0.667	0.30	0.021	0.30	0.789
0.35	0.317	0.35	0.617	0.35	0.034	0.35	0.733
0.40	0.367	0.40	0.567	0.40	0.055	0.40	0.670
0.45	0.417	0.45	0.517	0.45	0.085	0.45	0.599
0.50	0.467	0.50	0.467	0.50	0.123	0.50	0.525
0.55	0.517	0.55	0.417	0.55	0.172	0.55	0.452
0.60	0.567	0.60	0.367	0.60	0.226	0.60	0.383
0.65	0.617	0.65	0.317	0.65	0.285	0.65	0.317
0.70	0.667	0.70	0.267	0.70	0.347	0.70	0.255
0.75	0.717	0.75	0.217	0.75	0.413	0.75	0.197
0.80	0.767	0.80	0.167	0.80	0.482	0.80	0.143
0.85	0.817	0.85	0.117	0.85	0.553	0.85	0.092
0.90	0.867	0.90	0.068	0.90	0.626	0.90	0.046
0.95	0.917	0.95	0.023	0.95	0.700	0.95	0.013
1.00	0.967	1.00	0.000	1.00	0.775	1.00	0.000

P_{sy} shall be calculated as follows:

$$P_{sy} = (24.96 - 199.6y/B_s)(y/B_s)$$

$$\text{for } y/B_s \leq 0.05$$

¹³ For symmetrical tank arrangements, damages are considered for one side of the ship only, in which case all "y" dimensions are to be measured from that same side. For asymmetrical arrangements, reference is made to the Explanatory Notes on matters related to the accidental oil outflow performance, adopted by the Organization by resolution MEPC.122(52).

$$P_{Sy} = 0.749 + \{5 - 44.4(y/B_s - 0.05)\}(y/B_s - 0.05) \quad \text{for } 0.05 < y/B_s < 0.1$$

$$P_{Sy} = 0.888 + 0.56(y/B_s - 0.1) \quad \text{for } y/B_s \geq 0.1$$

P_{Sy} shall not be taken greater than 1.

9. The probability P_B of breaching a compartment from bottom damage shall be calculated as follows:

9.1. $P_B = P_{BL} P_{BT} P_{BV}$

where:

$P_{BL} = 1 - P_{Bf} - P_{Ba}$ = probability the damage will extend into the longitudinal zone bounded by X_a and X_f ;

$P_{BT} = 1 - P_{Bp} - P_{Bs}$ = probability the damage will extend into the transverse zone bounded by Y_p and Y_s ; and

$P_{BV} = 1 - P_{Bz}$ = probability the damage will extend vertically above the boundary defined by z .

9.2. P_{Ba} , P_{Bf} , P_{Bp} , P_{Bs} , and P_{Bz} shall be determined by linear interpolation from the tables of probabilities for bottom damage provided in paragraph 9.3 of this regulation, where:

P_{Ba} = the probability the damage will lie entirely aft of location X_a/L ;

P_{Bf} = the probability the damage will lie entirely forward of location X_f/L ;

P_{Bp} = the probability the damage will lie entirely to port of the tank;

P_{Bs} = the probability the damage will lie entirely to starboard of the tank; and

P_{Bz} = the probability the damage will lie entirely below the tank.

Compartment boundaries X_a , X_f , Y_p , Y_s , and z shall be developed as follows:

X_a and X_f are as defined in paragraph 8.2 of this regulation;

Y_p = the transverse distance from the port-most point on the compartment located at or below the waterline d_B , to a vertical plane located $B_B/2$ to starboard of the ship's centreline, in metres;

Y_s = the transverse distance from the starboard-most point on the compartment located at or below the waterline d_B , to a vertical plane located $B_B/2$ to starboard of the ship's centreline, in metres; and

z = the minimum value of z over the length of the compartment, where, at any given longitudinal location, z is the vertical distance from the lower point of the bottom shell at that longitudinal location to the lower point of the compartment at that longitudinal location, in metres.

9.3. Tables of probabilities for bottom damage

X_a/L	P_{Ba}	X_r/L	P_{Br}	Y_p/BB	P_{Bp}	Y_s/BB	P_{Bs}
0.00	0.000	0.00	0.969	0.00	0.844	0.00	0.000
0.05	0.002	0.05	0.953	0.05	0.794	0.05	0.009
0.10	0.008	0.10	0.936	0.10	0.744	0.10	0.032
0.15	0.017	0.15	0.916	0.15	0.694	0.15	0.063
0.20	0.029	0.20	0.894	0.20	0.644	0.20	0.097
0.25	0.042	0.25	0.870	0.25	0.594	0.25	0.133
0.30	0.058	0.30	0.842	0.30	0.544	0.30	0.171
0.35	0.076	0.35	0.810	0.35	0.494	0.35	0.211
0.40	0.096	0.40	0.775	0.40	0.444	0.40	0.253
0.45	0.119	0.45	0.734	0.45	0.394	0.45	0.297
0.50	0.143	0.50	0.687	0.50	0.344	0.50	0.344
0.55	0.171	0.55	0.630	0.55	0.297	0.55	0.394
0.60	0.203	0.60	0.563	0.60	0.253	0.60	0.444
0.65	0.242	0.65	0.489	0.65	0.211	0.65	0.494
0.70	0.289	0.70	0.413	0.70	0.171	0.70	0.544
0.75	0.344	0.75	0.333	0.75	0.133	0.75	0.594
0.80	0.409	0.80	0.252	0.80	0.097	0.80	0.644
0.85	0.482	0.85	0.170	0.85	0.063	0.85	0.694
0.90	0.565	0.90	0.089	0.90	0.032	0.90	0.744
0.95	0.658	0.95	0.026	0.95	0.009	0.95	0.794
1.00	0.761	1.00	0.000	1.00	0.000	1.00	0.844

P_{Bz} shall be calculated as follows:

$$P_{Bz} = (14.5 - 67z/D_s)(z/D_s) \quad \text{for } z/D_s \leq 0.1,$$

$$P_{Bz} = 0.78 + 1.1(z/D_s - 0.1) \quad \text{for } z/D_s > 0.1.$$

P_{Bz} shall not be taken greater than 1.

10. This regulation uses a simplified probabilistic approach where a summation is carried out over the contributions to the mean outflow from each cargo tank. For certain designs, such as those characterized by the occurrence of steps/recesses in bulkheads/decks and for sloping bulkheads and/or a pronounced hull curvature, more rigorous calculations may be appropriate. In such cases one of the following calculation procedures may be applied:

10.1. The probabilities referred to in 8 and 9 above may be calculated with more precision through application of hypothetical subcompartments.¹⁴

10.2. The probabilities referred to in 8 and 9 above may be calculated through direct application of the probability density functions contained in the Guidelines referred to in regulation 19.5.

10.3. The oil outflow performance may be evaluated in accordance with the method described in the Guidelines referred to in regulation 19.5.

¹⁴ Reference is made to the Explanatory Notes on matters related to the accidental oil outflow performance, adopted by the Organization by resolution MEPC.122(52), as amended and changed by MEPC.146(54).

11. The following provisions regarding piping arrangements shall apply:
- 11.1. Lines of piping that run through cargo tanks in a position less than $0.30B_S$ from the ship's side or less than $0.30D_S$ from the ship's bottom shall be fitted with valves or similar closing devices at the point at which they open into any cargo tank. These valves shall be kept closed at sea at any time when the tanks contain cargo oil, except that they may be opened only for cargo transfer needed for essential cargo operations.
 - 11.2. Credit for reducing oil outflow through the use of an emergency rapid cargo transfer system or other system arranged to mitigate oil outflow in the event of an accident may be taken into account only after the effectiveness and safety aspects of the system are approved by the Organization. Submittal for approval shall be made in accordance with the provisions of the Guidelines referred to in regulation 19.5.

S Regulation 24 – Damage assumptions

1. For the purpose of calculating hypothetical oil outflow from oil tankers in accordance with regulations 25 and 26, three dimensions of the extent of damage of a parallelepiped on the side and bottom of the ship are assumed as follows. In the case of bottom damages two conditions are set forth to be applied individually to the stated portions of the oil tanker.

1.1. Side damage:

2. 1) Longitudinal extent (l_c):	whichever is less $\frac{1}{3}L^{\frac{2}{3}}$ or 14.5 m
2) Transverse extent (t_c) (inboard from the ship's side at right angles to the centreline at the level corresponding to the assigned summer freeboard):	whichever is less $\frac{B}{5}$ or 11.5 m
3) Vertical extent (v_c):	From the baseline upwards without limit

2.1. Bottom damage:

For 0.3L from the forward perpendicular of the ship	Any other part of the ship
1) Longitudinal extent	
$(l_s): \frac{L}{10}$	whichever is less: $\frac{L}{10}$ or 5 m
2) Transverse extent (ts):	
whichever is less $\frac{B}{6}$ or 10 m but not less than 5 m	5 m
3) Vertical extent from the baseline (v_s):	
whichever is less $\frac{B}{15}$ or 6 m	whichever is less $\frac{B}{15}$ or 6 m

3. Wherever the symbols given in this regulation appear in this chapter, they have the meaning as defined in this regulation.

S Regulation 25 – Hypothetical outflow of oil

Oil tankers delivered before 1 January 2010

1. The hypothetical outflow of oil in the case of side damage (O_c) and bottom damage (O_s) shall be calculated by the following formulae with respect to compartments breached by damage to all conceivable locations along the length of the ship to the extent as defined in regulation 24 of this Chapter.

1.1. For side damages: $O_c = \sum W_i + \sum K_i C_i$ (I)

1.2. For bottom damages: $O_s = \frac{1}{3} \left(\sum Z_i W_i + \sum Z_i C_i \right)$ (II)

where:

W_i = volume of a wing tank, in cubic metres, assumed to be breached by the damage as specified in regulation 24 of this Chapter; W_i for a segregated ballast tank may be taken equal to zero.

C_i = volume of a centre tank, in cubic metres, assumed to be breached by the damage as specified in regulation 24 of this Chapter; C_i for a segregated ballast tank may be taken equal to zero.

$K_i = 1 - \frac{b_i}{t_c}$ when b_i is equal to or greater than t_c , K_i shall be taken equal to zero.

$Z_i = 1 - \frac{h_i}{v_s}$ when h_i is equal to or greater than v_s , Z_i shall be taken equal to zero.

$b_i =$ width of wing tank under consideration, in metres, measured inboard from the ship's side at right angles to the centreline at the level corresponding to the assigned summer freeboard.

$h_i =$ minimum depth of the double bottom under consideration, in metres; where no double bottom is fitted, h_i shall be taken equal to zero.

Whenever symbols given in this paragraph appear in this chapter, they have the meaning as defined in this regulation.

2. If a void space or segregated ballast tank of a length less than l_c as defined in regulation 24 of this Chapter is located between wing oil tanks, O_c in formula (I) may be calculated on the basis of volume W_i being the actual volume of one such tank (where they are of equal capacity) or the smaller of the two tanks (if they differ in capacity) adjacent to such space, multiplied by S_i as defined below and taking for all other wing tanks involved in such collision the value of the actual full volume.

$$S_i = 1 - \frac{l_i}{l_c}$$

where $l_i =$ length, in metres, of void space or segregated ballast tank under consideration.

- 3.
- 3.1. Credit shall only be given in respect of double bottom tanks which are either empty or carrying clean water when cargo is carried in the tanks above.
- 3.2. Where the double bottom does not extend for the full length and width of the tank involved, the double bottom is considered non-existent and the volume of the tanks above the area of the bottom damage shall be included in formula (II) even if the tank is not considered breached because of the installation of such a partial double bottom.
- 3.3. Suction wells may be neglected in the determination of the value h_i provided such wells are not excessive in area and extend below the tank for a minimum distance and in no case more than half the height of the double bottom. If the depth of such a well exceeds half the height of the double bottom, h_i shall be taken equal to the double bottom height minus the well height.

Piping serving such wells if installed within the double bottom shall be fitted with valves or other closing arrangements located at the point of connection to the tank served to prevent oil outflow in the event of damage to the piping. Such piping shall be installed as high from the bottom shell as possible. These valves shall be kept closed at sea at any time when the tank contains oil cargo, except that they may be opened only for cargo transfer needed for the purpose of trimming of the ship.

4. In the case where bottom damage simultaneously involves four centre tanks, the value of O_s may be calculated according to the formula:

$$O_s = \frac{1}{4} \left(\sum Z_i W_i + \sum Z_i C_i \right) \quad \text{(III)}$$

5. An Administration may credit as reducing oil outflow in case of bottom damage, an installed cargo transfer system having an emergency high suction in each cargo oil tank, capable of transferring

from a breached tank or tanks to segregated ballast tanks or to available cargo tankage if it can be assured that such tanks will have sufficient ullage. Credit for such a system would be governed by ability to transfer in two hours of operation oil equal to one half of the largest of the breached tanks involved and by availability of equivalent receiving capacity in ballast or cargo tanks. The credit shall be confined to permitting calculation of O_s according to formula (III). The pipes for such suction shall be installed at least at a height not less than the vertical extent of the bottom damage v_s . The Administration shall supply the Organization with the information concerning the arrangements accepted by it, for circulation to other Parties to the Convention.

6. This regulation does not apply to oil tankers delivered on or after 1 January 2010, as defined in regulation 1.28.8.

S Regulation 26 – Limitations of size and arrangement of cargo tanks

Oil tankers delivered before 1 January 2010

1. Except as provided in paragraph 7 below:
 - 1.1. every oil tanker of 150 gross tonnage and above delivered after 31 December 1979, as defined in regulation 1.28.2, and
 - 1.2. every oil tanker of 150 gross tonnage and above delivered on or before 31 December 1979, as defined in regulation 1.28.1, which falls into either of the following categories:
 - 1.2.1. a tanker, the delivery of which is after 1 January 1977, or
 - 1.2.2. a tanker to which both the following conditions apply:
 - 1.2.2.1. delivery is not later than 1 January 1977; and
 - 1.2.2.2. the building contract is placed after 1 January 1974,
 - 1.2.2.3. or in cases where no building contract has previously been placed, the keel is laid or the tanker is at a similar stage of construction after 30 June 1974 shall comply with the provisions of this regulation.
2. Cargo tanks of oil tankers shall be of such size and arrangements that the hypothetical outflow O_c or O_s calculated in accordance with the provisions of regulation 25 of this Chapter anywhere in the length of the ship does not exceed 30,000 cubic metres or , whichever is the greater, but subject to a maximum of 40,000 cubic metres.
3. The volume of any one wing cargo oil tank of an oil tanker shall not exceed 75 per cent of the limits of the hypothetical oil outflow referred to in paragraph 2 of this regulation. The volume of any one centre cargo oil tank shall not exceed 50,000 cubic metres. However, in segregated ballast oil tankers as defined in regulation 18 of this Chapter, the permitted volume of a wing cargo oil tank situated between two segregated ballast tanks, each exceeding l_c in length, may be increased to the maximum limit of hypothetical oil outflow provided that the width of the wing tanks exceeds t_c .
4. The length of each cargo tank shall not exceed 10 m or one of the following values, whichever is the greater:
 - 4.1. where no longitudinal bulkhead is provided inside the cargo tanks:

$$(0,5 \frac{b_i}{B} + 0,1)L$$
, but not to exceed $0.2L$
 - 4.2. where a centreline longitudinal bulkhead is provided inside the cargo tanks:

$$(0,25 \frac{b_i}{B} + 0,15)L$$
 - 4.3. where two or more longitudinal bulkheads are provided inside the cargo tanks:

4.3.1. for wing cargo tanks: $0.2L$

4.3.2. for centre cargo tanks:

4.3.2.1. if $\frac{b_i}{B} \geq \frac{1}{5}$: is equal to or greater than one fifth: $0.2L$

4.3.2.2. if $\frac{b_i}{B} < \frac{1}{5}$: is less than one fifth:

- where no centreline longitudinal bulkhead is provided:

$$(0.5 \frac{b_i}{B} + 0.1)L$$

- where a centreline longitudinal bulkhead is provided:

$$(0.25 \frac{b_i}{B} + 0.15)L$$

4.4. b_i is the minimum distance from the ship's side to the outer longitudinal bulkhead of the tank in question measured inboard at right angles to the centreline at the level corresponding to the assigned summer freeboard.

5. In order not to exceed the volume limits established by paragraphs 2, 3 and 4 of this regulation and irrespective of the accepted type of cargo transfer system installed, when such system interconnects two or more cargo tanks, valves or other similar closing devices shall be provided for separating the tanks from each other. These valves or devices shall be closed when the tanker is at sea.
6. Lines of piping which run through cargo tanks in a position less than t_c from the ship's side or less than 'vc' from the ship's bottom shall be fitted with valves or similar closing devices at the point at which they open into any cargo tank. These valves shall be kept closed at sea at any time when the tanks contain cargo oil, except that they may be opened only for cargo transfer needed for the purpose of trimming of the ship.
7. This regulation does not apply to oil tankers delivered on or after 1 January 2010, as defined in regulation 1.28.8.

S Regulation 27 – Intact stability

1. Every oil tanker of 5,000 tonnes deadweight and above delivered on or after 1 February 2002, as defined in regulation 1.28.7, shall comply with the intact stability criteria specified in paragraphs 1.1 and 1.2 of this regulation, as appropriate, for any operating draught under the worst possible conditions of cargo and ballast loading, consistent with good operational practice, including intermediate stages of liquid transfer operations. Under all conditions the ballast tanks shall be assumed slack.
 - 1.1. In port, the initial metacentric height GM_o , corrected for the free surface measured at 0° heel, shall be not less than 0.15 m;
 - 1.2. At sea, the following criteria shall be applicable:
 - 1.2.1. the area under the righting lever curve (GZ curve) shall be not less than 0.055 m·rad up to $\theta = 30^\circ$ angle of heel and not less than 0.09 m·rad up to $\theta = 40^\circ$ or other angle of flooding θ_f^{15} if this angle is less than 40° . Additionally, the area under the righting

¹⁵ θ_f is the angle of heel at which openings in the hull superstructures or deckhouses which cannot be closed weathertight immerse. In applying this criterion, small openings through which progressive flooding cannot take place need not be considered as open.

- lever curve (GZ curve) between the angles of heel of 30° and 40° or between 30° and θ_f , if this angle is less than 40°, shall be not less than 0.03 m·rad;
 - 1.2.2. the righting lever GZ shall be at least 0.20 m at an angle of heel equal to or greater than 30°;
 - 1.2.3. the maximum righting arm shall occur at an angle of heel preferably exceeding 30° but not less than 25°; and
 - 1.2.4. the initial metacentric height GM_o , corrected for free surface measured at 0° heel, shall be not less than 0.15 m.
2. The requirements of paragraph 1 of this regulation shall be met through design measures. For combination carriers simple supplementary operational procedures may be allowed.
 3. Simple supplementary operational procedures for liquid transfer operations referred to in paragraph 2 of this regulation shall mean written procedures made available to the master which:
 - 3.1. are approved by the Administration;
 - 3.2. indicate those cargo and ballast tanks which may, under any specific condition of liquid transfer and possible range of cargo densities, be slack and still allow the stability criteria to be met. The slack tanks may vary during the liquid transfer operations and be of any combination provided they satisfy the criteria;
 - 3.3. will be readily understandable to the officer-in-charge of liquid transfer operations;
 - 3.4. provide for planned sequences of cargo/ballast transfer operations;
 - 3.5. allow comparisons of attained and required stability using stability performance criteria in graphical or tabular form;
 - 3.6. require no extensive mathematical calculations by the officer-in-charge;
 - 3.7. provide for corrective actions to be taken by the officer-in-charge in case of departure from recommended values and in case of emergency situations; and
 - 3.8. are prominently displayed in the approved trim and stability booklet and at the cargo/ballast transfer control station and in any computer software by which stability calculations are performed.

S Regulation 28 – Subdivision and damage stability

1. Every oil tanker delivered after 31 December 1979, as defined in regulation 1.28.2, of 150 gross tonnage and above, shall comply with the subdivision and damage stability criteria as specified in paragraph 3 of this regulation, after the assumed side or bottom damage as specified in paragraph 2 of this regulation, for any operating draught reflecting actual partial or full load conditions consistent with trim and strength of the ship as well as relative densities of the cargo. Such damage shall be applied to all conceivable locations along the length of the ship as follows:
 - 1.1. in tankers of more than 225 m in length, anywhere in the ship's length;
 - 1.2. in tankers of more than 150 m, but not exceeding 225 m in length, anywhere in the ship's length except involving either after or forward bulkhead bounding the machinery space located aft. The machinery space shall be treated as a single floodable compartment; and
 - 1.3. in tankers not exceeding 150 m in length, anywhere in the ship's length between adjacent transverse bulkheads with the exception of the machinery space. For tankers of 100 m or less in length where all requirements of paragraph 3 of this regulation cannot be fulfilled without materially impairing the operational qualities of the ship, Administrations may allow relaxations from these requirements.

Ballast conditions where the tanker is not carrying oil in cargo tanks, excluding any oil residues, shall not be considered.

2. The following provisions regarding the extent and the character of the assumed damage shall apply:

2.1. Side damage:

1) Longitudinal extent:	whichever is less $\frac{1}{3}L^{\frac{2}{3}}$ or 14.5 m
2) Transverse extent (inboard from the ship's side at right angles to the centreline at the level of the summer load line):	whichever is less $\frac{B}{5}$ or 11.5 m
3) Vertical extent:	From the baseline upwards without limit

2.2. Bottom damage

For 0.3L from the forward perpendicular of the ship	Any other part of the ship
1) Longitudinal extent:	
whichever is less $\frac{1}{3}L^{\frac{2}{3}}$ or 14.5 m,	whichever is less: $\frac{1}{3}L^{\frac{2}{3}}$ or 14.5 m
2) Transverse extent (ts):	
whichever is less $\frac{B}{6}$ or 10 m	whichever is less $\frac{B}{6}$ or 5 m
3) Vertical extent:	
whichever is less $\frac{B}{15}$ or 6 m measured from the moulded line of the bottom shell plating at centreline	whichever is less $\frac{B}{15}$ or 6 m measured from the moulded line of the bottom shell plating at centreline

- 2.3. If any damage of a lesser extent than the maximum extent of damage specified in subparagraphs 2.1 and 2.2 of this paragraph would result in a more severe condition, such damage shall be considered.
- 2.4. Where the damage involving transverse bulkheads is envisaged as specified in subparagraphs 1.1 and 1.2 of this regulation, transverse watertight bulkheads shall be spaced at least at a distance equal to the longitudinal extent of assumed damage specified in subparagraph 2.1 of this paragraph in order to be considered effective. Where transverse bulkheads are spaced at a lesser distance, one or more of these bulkheads within such extent of damage shall be assumed as non-existent for the purpose of determining flooded compartments.
- 2.5. Where the damage between adjacent transverse watertight bulkheads is envisaged as specified in subparagraph 1.3 of this regulation, no main transverse bulkhead or a transverse bulkhead bounding side tanks or double bottom tanks shall be assumed damaged, unless:
 - 2.5.1. the spacing of the adjacent bulkheads is less than the longitudinal extent of assumed damage specified in subparagraph 2.1 of this paragraph; or
 - 2.5.2. there is a step or recess in a transverse bulkhead of more than 3.05 m in length, located within the extent of penetration of assumed damage. The step formed by the after peak bulkhead and after peak top shall not be regarded as a step for the purpose of this regulation.
- 2.6. If pipes, ducts or tunnels are situated within the assumed extent of damage, arrangements shall be made so that progressive flooding cannot thereby extend to compartments other than those assumed to be floodable for each case of damage.
3. Oil tankers shall be regarded as complying with the damage stability criteria if the following requirements are met:
 - 3.1. The final waterline, taking into account sinkage, heel and trim, shall be below the lower edge of any opening through which progressive flooding may take place. Such openings shall include air-pipes and those which are closed by means of weathertight doors or hatch covers and may exclude those openings closed by means of watertight manhole covers and flush scuttles, small watertight cargo tank hatch covers which maintain the high integrity of the deck, remotely operated watertight sliding doors, and sidescuttles of the non-opening type.
 - 3.2. In the final stage of flooding, the angle of heel due to unsymmetrical flooding shall not exceed 25°, provided that this angle may be increased up to 30° if no deck edge immersion occurs.
 - 3.3. The stability in the final stage of flooding shall be investigated and may be regarded as sufficient if the righting lever curve has at least a range of 20° beyond the position of equilibrium in association with a maximum residual righting lever of at least 0.1 m within the 20° range; the area under the curve within this range shall not be less than 0.0175 m-rad. Unprotected openings shall not be immersed within this range unless the space concerned is assumed to be flooded. Within this range, the immersion of any of the openings listed in subparagraph 3.1 of this paragraph and other openings capable of being closed weathertight may be permitted.
 - 3.4. The Administration shall be satisfied that the stability is sufficient during intermediate stages of flooding.
 - 3.5. Equalization arrangements requiring mechanical aids such as valves or cross-levelling pipes, if fitted, shall not be considered for the purpose of reducing an angle of heel or attaining the minimum range of residual stability to meet the requirements of subparagraphs 3.1, 3.2 and

3.3 of this paragraph and sufficient residual stability shall be maintained during all stages where equalization is used. Spaces which are linked by ducts of a large cross-sectional area may be considered to be common.

4. The requirements of paragraph 1 of this regulation shall be confirmed by calculations which take into consideration the design characteristics of the ship, the arrangements, configuration and contents of the damaged compartments; and the distribution, relative densities and the free surface effect of liquids. The calculations shall be based on the following:

4.1. Account shall be taken of any empty or partially filled tank, the relative density of cargoes carried, as well as any outflow of liquids from damaged compartments.

4.2. The permeabilities assumed for spaces flooded as a result of damage shall be as follows:

Spaces	Permeabilities
Appropriated to stores	0.60
Occupied by accommodation	0.95
Occupied by machinery	0.85
Voids	0.95
Intended for consumable liquids	0 to 0.95*
Intended for other liquids	0 to 0.95**

* The permeability of partially filled compartments shall be consistent with the amount of liquid carried in the compartment. Whenever damage penetrates a tank containing liquids, it shall be assumed that the contents are completely lost from that compartment and replaced by salt water up to the level of the final plane of equilibrium.

** See above.

4.3. The buoyancy of any superstructure directly above the side damage shall be disregarded. The unflooded parts of superstructures beyond the extent of damage, however, may be taken into consideration provided that they are separated from the damaged space by watertight bulkheads and the requirements of subparagraph .3.1 of this regulation in respect of these intact spaces are complied with. Hinged watertight doors may be acceptable in watertight bulkheads in the superstructure.

4.4. The free surface effect shall be calculated at an angle of heel of 5° for each individual compartment. The Administration may require or allow the free surface corrections to be calculated at an angle of heel greater than 5° for partially filled tanks.

4.5. In calculating the effect of free surfaces of consumable liquids it shall be assumed that, for each type of liquid, at least one transverse pair or a single centreline tank has a free surface and the tank or combination of tanks to be taken into account shall be those where the effect of free surface is the greatest.

5. The master of every oil tanker to which this regulation applies and the person in charge of a non-self-propelled oil tanker to which this regulation applies shall be supplied in an approved form with:

5.1. information relative to loading and distribution of cargo necessary to ensure compliance with the provisions of this regulation; and

5.2. data on the ability of the ship to comply with damage stability criteria as determined by this regulation, including the effect of relaxations that may have been allowed under subparagraph 1.3 of this regulation.

6. For oil tankers of 20,000 tonnes deadweight and above delivered on or after 6 July 1996, as defined in regulation 1.28.6, the damage assumptions prescribed in paragraph 2.2 of this regulation shall be supplemented by the following assumed bottom raking damage:
 - 6.1. longitudinal extent:
 - 6.1.1. ships of 75,000 tonnes deadweight and above: $0.6L$ measured from the forward perpendicular;
 - 6.1.2. ships of less than 75,000 tonnes deadweight: $0.4L$ measured from the forward perpendicular;
 - 6.2. transverse extent: $B/3$ anywhere in the bottom;
 - 6.3. vertical extent: breach of the outer hull.

S Regulation 29 – Slop tanks

1. Subject to the provisions of paragraph 4 of regulation 3 of this Chapter, oil tankers of 150 gross tonnage and above shall be provided with slop tank arrangements in accordance with the requirements of paragraphs 2.1 to 2.3 of this regulation. In oil tankers delivered on or before 31 December 1979, as defined in regulation 1.28.1, any cargo tank may be as a slop tank.
2.
 - 2.1. Adequate means shall be provided for cleaning the cargo tanks and transferring the dirty ballast residue and tank washings from the cargo tanks into a slop tank approved by the Administration.
 - 2.2. In this system arrangements shall be provided to transfer the oily waste into a slop tank or combination of slop tanks in such a way that any effluent discharged into the sea will be such as to comply with the provisions of regulation 34 of this Chapter.
 - 2.3. The arrangements of the slop tank or combination of slop tanks shall have a capacity necessary to retain the slop generated by tank washings, oil residues and dirty ballast residues. The total capacity of the slop tank or tanks shall not be less than 3 per cent of the oil-carrying capacity of the ship, except that the Administration may accept:
 - 2.3.1. 2% for such oil tankers where the tank washing arrangements are such that once the slop tank or tanks are charged with washing water, this water is sufficient for tank washing and, where applicable, for providing the driving fluid for eductors, without the introduction of additional water into the system;
 - 2.3.2. 2% where segregated ballast tanks or dedicated clean ballast tanks are provided in accordance with regulation 18 of this Chapter, or where a cargo tank cleaning system using crude oil washing is fitted in accordance with regulation 33 of this Chapter. This capacity may be further reduced to 1.5% for such oil tankers where the tank washing arrangements are such that once the slop tank or tanks are charged with washing water, this water is sufficient for tank washing and, where applicable, for providing the driving fluid for eductors, without the introduction of additional water into the system; and
 - 2.3.3. 1% for combination carriers where oil cargo is only carried in tanks with smooth walls. This capacity may be further reduced to 0.8% where the tank washing arrangements are such that once the slop tank or tanks are charged with washing water, this water is sufficient for tank washing and, where applicable, for providing the driving fluid for

eductors, without the introduction of additional water into the system. New oil tankers of 70,000 tonnes deadweight and above shall be provided with a least two slop tanks.

- 2.4. Slop tanks shall be so designed, particularly in respect of the position of inlets, outlets, baffles or weirs where fitted, so as to avoid excessive turbulence and entrainment of oil or emulsion with the water.
3. Oil tankers of 70,000 tonnes deadweight and above delivered after 31 December 1979, as defined in regulation 1.28.2, shall be provided with at least two slop tanks.

S Regulation 30 – Pumping, piping and discharge arrangement

1. In every oil tanker, a discharge manifold for connection to reception facilities for the discharge of dirty ballast water or oil-contaminated water shall be located on the open deck on both sides of the ship.
2. In every oil tanker of 150 gross tonnage and above, pipelines for the discharge to the sea of ballast water or oil-contaminated water from cargo tank areas which may be permitted under regulation 34 of this Chapter shall be led to the open deck or to the ship's side above the waterline in the deepest ballast condition. Different piping arrangements to permit operation in the manner permitted in subparagraphs 6.1 to 6.5 of this regulation may be accepted.
3. In oil tankers of 150 gross tonnage and above delivered after 31 December 1979, as defined in regulation 1.28.2, means shall be provided for stopping the discharge into the sea of ballast water or oil-contaminated water from cargo tank areas, other than those discharges below the waterline permitted under paragraph 6 of this regulation, from a position on the upper deck or above located so that the manifold in use referred to in paragraph 1 of this regulation and the discharge to the sea from the pipelines referred to in paragraph 2 of this regulation may be visually observed. Means for stopping the discharge need not be provided at the observation position if a positive communication system such as a telephone or radio system is provided between the observation position and the discharge control position.
4. Every oil tanker delivered after 1 June 1982, as defined in regulation 1.28.4, required to be provided with segregated ballast tanks or fitted with a crude oil washing system, shall comply with the following requirements:
 - 4.1. it shall be equipped with oil piping so designed and installed that oil retention in the lines is minimized; and
 - 4.2. means shall be provided to drain all cargo pumps and all oil lines at the completion of cargo discharge, where necessary by connection to a stripping device. The line and pump draining shall be capable of being discharged both ashore and to a cargo tank or a slop tank. For discharge ashore a special small diameter line shall be provided and shall be connected outboard of the ship's manifold valves.
5. Every crude oil tanker delivered on or before 1 June 1982, as defined in regulation 1.28.3, required to be provided with segregated ballast tanks, or to be fitted with a crude oil washing system, shall comply with the provisions of paragraph 4.2 of this regulation.
6. On every oil tanker the discharge of ballast water or oil contaminated water from cargo tank areas shall take place above the waterline, except as follows:
 - 6.1. Segregated ballast and clean ballast may be discharged below the waterline:
 - 6.1.1. in ports or at offshore terminals, or
 - 6.1.2. at sea by gravity, or

- 6.1.3. at sea by pumps if the ballast water exchange is performed under the provisions of regulation D-1.1 of the International Convention for the Control and Management of Ships' Ballast Water and Sediments,
provided that the surface of the ballast water has been examined either visually or by other means immediately before the discharge to ensure that no contamination with oil has taken place.
- 6.2. Oil tankers delivered on or before 31 December 1979, as defined in regulation 1.28.1, which, without modification, are not capable of discharging segregated ballast above the waterline may discharge segregated ballast below the waterline at sea, provided that the surface of the ballast water has been examined immediately before the discharge to ensure that no contamination with oil has taken place.
- 6.3. Oil tankers delivered on or before 1 June 1982, as defined in regulation 1.28.3, operating with dedicated clean ballast tanks, which without modification are not capable of discharging ballast water from dedicated clean ballast tanks above the waterline, may discharge this ballast below the waterline provided that the discharge of the ballast water is supervised in accordance with regulation 18.8.3 of this Chapter.
- 6.4. On every oil tanker at sea, dirty ballast water or oil contaminated water from tanks in the cargo area, other than slop tanks, may be discharged by gravity below the waterline, provided that sufficient time has elapsed in order to allow oil/water separation to have taken place and the ballast water has been examined immediately before the discharge with an oil/water interface detector referred to in regulation 32 of this Chapter, in order to ensure that the height of the interface is such that the discharge does not involve any increased risk of harm to the marine environment.
- 6.5. On oil tankers delivered on or before 31 December 1979, as defined in regulation 1.28.1, at sea dirty ballast water or oil contaminated water from cargo tank areas may be discharged below the waterline, subsequent to or in lieu of the discharge by the method referred to in subparagraph 6.4 of this paragraph, provided that:
- 6.5.1. a part of the flow of such water is led through permanent piping to a readily accessible location on the upper deck or above where it may be visually observed during the discharge operation; and
- 6.5.2. such part flow arrangements comply with the requirements established by the Administration, which shall contain at least all the provisions of the Specifications for the Design, Installation and Operation of a Part Flow System for Control of Overboard Discharges adopted by the Organization.¹⁶
7. Every oil tanker of 150 gross tonnage and above delivered on or after 1 January 2010, as defined in regulation 1.28.8, which has installed a sea chest that is permanently connected to the cargo pipeline system, shall be equipped with both a sea chest valve and an inboard isolation valve. In addition to these valves, the sea chest shall be capable of isolation from the cargo piping system whilst the tanker is loading, transporting, or discharging cargo by use of a positive means that is to the satisfaction of the Administration. Such a positive means is a facility that is installed in the pipeline system in order to prevent, under all circumstances, the section of pipeline between the sea chest valve and the inboard valve being filled with cargo.

¹⁶ See appendix 4 to Unified Interpretations.

Part B – Equipment

S Regulation 31 – Oil discharge monitoring and control system

1. Subject to the provisions of paragraphs 4 and 5 of regulation 3 of this Chapter, oil tankers of 150 gross tonnage and above shall be equipped with an oil discharge monitoring and control system approved by the Administration.
2. In considering the design of the oil content meter to be incorporated in the system, the Administration shall have regard to the specification recommended by the Organization.¹⁷ The system shall be fitted with a recording device to provide a continuous record of the discharge in litres per nautical mile and total quantity discharged, or the oil content and rate of discharge. This record shall be identifiable as to time and date and shall be kept for at least three years. The oil discharge monitoring and control system shall come into operation when there is any discharge of effluent into the sea and shall be such as will ensure that any discharge of oily mixture is automatically stopped when the instantaneous rate of discharge of oil exceeds that permitted by regulation 34 of this Chapter. Any failure of this monitoring and control system shall stop the discharge. In the event of failure of the oil discharge monitoring and control system a manually operated alternative method may be used, but the defective unit shall be made operable as soon as possible. Subject to allowance by the port State authority, a tanker with a defective oil discharge monitoring and control system may undertake one ballast voyage before proceeding to a repair port.
3. The oil discharge monitoring and control system shall be designed and installed in compliance with the guidelines and specifications for oil discharge monitoring and control systems for oil tankers developed by the Organization¹⁸. Administrations may accept such specific arrangements as detailed in the Guidelines and Specifications.
4. Instructions as to the operation of the system shall be in accordance with an operational manual approved by the Administration. They shall cover manual as well as automatic operations and shall be intended to ensure that at no time shall oil be discharged except in compliance with the conditions specified in regulation 34 of this Chapter.

S Regulation 32 – Oil/water interface detector¹⁹

Subject to the provisions of paragraphs 4 and 5 of regulation 3 of this Chapter, oil tankers of 150 gross tonnage and above shall be provided with effective oil/water interface detectors approved by the Administration for a rapid and accurate determination of the oil/water interface in slop tanks and shall

¹⁷ For oil content meters installed on oil tankers built prior to 2 October 1986, refer to the Recommendation on international performance and test specifications for oily-water separating equipment and oil content meters adopted by the Organization by resolution A.393(X). For oil content meters as part of discharge monitoring and control systems installed on oil tankers built on or after 2 October 1986, refer to the Guidelines and specifications for oil discharge monitoring and control systems for oil tankers adopted by the Organization by resolution A.586(14). For oil content meters as part of discharge monitoring and control systems installed on oil tankers built on or after 1 January 2005, refer to the revised Guidelines and specifications for oil discharge monitoring and control systems for oil tankers adopted by the Organization by resolution MEPC.108(49).

¹⁸ Refer to the Guidelines and specifications for oil discharge monitoring and control systems for oil tankers adopted by the Organization by resolution A.496(XII) or the Revised Guidelines and specifications for oil discharge monitoring and control systems for oil tankers adopted by the Organization by resolution A.586(14), or the Revised Guidelines and specifications for oil discharge monitoring and control systems for oil tankers adopted by the Organization by resolution MEPC.108(49) as applicable.

¹⁹ Refer to the Specifications for oil/water interface detectors adopted by the Organization by resolution MEPC.5(XIII).

be available for use in other tanks where the separation of oil and water is effected and from which it is intended to discharge effluent direct to the sea.

S Regulation 33 – Crude oil washing requirements

1. Every crude oil tanker of 20,000 tonnes deadweight and above delivered after 1 June 1982, as defined in regulation 1.28.4, shall be fitted with a cargo tank cleaning system using crude oil washing. The Administration shall ensure that the system fully complies with the requirements of this regulation within one year after the tanker was first engaged in the trade of carrying crude oil or by the end of the third voyage carrying crude oil suitable for crude oil washing, whichever occurs later.
2. Crude oil washing installation and associated equipment and arrangements shall comply with the requirements established by the Administration. Such requirements shall contain at least all the provisions of the Specifications for the Design, Operation and Control of Crude Oil Washing Systems adopted by the Organization.²⁰ When a ship is not required, in accordance with paragraph 1 of this regulation, to be, but is equipped with crude oil washing equipment, it shall comply with the safety aspects of the above-mentioned Specifications.
3. Every crude oil washing system required to be provided in accordance with regulation 18.7 of this Chapter shall comply with the requirements of this regulation.

Part C – Control of operational discharges of oil

M Regulation 34 – Control of discharge of oil

Attention is drawn to the fact that the following regulation is the Danish Maritime Authority's translation of MARPOL. As regards Danish legislation, reference is made to the Ministry of the Environment.

A – Discharges outside special areas

1. Subject to the provisions of regulation 4 of this Chapter and paragraph 2 of this regulation, any discharge into the sea of oil or oily mixtures from the cargo area of an oil tanker shall be prohibited except when all the following conditions are satisfied:²¹
 - 1.1. the tanker is not within a special area;
 - 1.2. the tanker is more than 50 nautical miles from the nearest land;
 - 1.3. the tanker is proceeding en route;
 - 1.4. the instantaneous rate of discharge of oil content does not exceed 30 litres per nautical mile;
 - 1.5. the total quantity of oil discharged into the sea does not exceed for tankers delivered on or before 31 December 1979, as defined in regulation 1.28.1, 1/15,000 of the total quantity of the particular cargo of which the residue formed a part, and for tankers delivered after 31 December 1979, as defined in regulation 1.28.2, 1/30,000 of the total quantity of the particular cargo of which the residue formed a part; and

²⁰ Refer to the revised Specifications for the design, operation and control of crude oil washing systems adopted by the Organization by resolution A.446(XI) and amended by the Organization by resolution A.497(XII) and as further amended by resolution A.897(21) – Control of operational discharges of oil.

²¹ *This shall not apply to Danish territorial waters where any discharge of oil is prohibited, cf. the Act on Protection of the Marine Environment.*

- 1.6. the tanker has in operation an oil discharge monitoring and control system and a slop tank arrangement as required by regulations 29 and 31 of this Chapter.
2. The provisions of paragraph 1 of this regulation shall not apply to the discharge of clean or segregated ballast.

B – Discharges in special areas

3. Subject to the provisions of paragraph 4 of this regulation, any discharge into the sea of oil or oily mixture from the cargo area of an oil tanker shall be prohibited while in a special area.²²
4. The provisions of paragraph 3 of this regulation shall not apply to the discharge of clean or segregated ballast.
5. Nothing in this regulation shall prohibit a ship on a voyage only part of which is in a special area from discharging outside the special area in accordance with paragraph 1 of this regulation.

C – Requirements for oil tankers of less than 150 gross tonnage

6. The requirements of regulations 29, 31 and 32 of this Chapter shall not apply to oil tankers of less than 150 gross tonnage, for which the control of discharge of oil under this regulation shall be effected by the retention of oil on board with subsequent discharge of all contaminated washings to reception facilities. The total quantity of oil and water used for washing and returned to a storage tank shall be discharged to reception facilities unless adequate arrangements are made to ensure that any effluent which is allowed to be discharged into the sea is effectively monitored to ensure that the provisions of this regulation are complied with.

D – General requirements

7. Whenever visible traces of oil are observed on or below the surface of the water in the immediate vicinity of a ship or its wake, the Governments of Parties to the present Convention should, to the extent they are reasonably able to do so, promptly investigate the facts bearing on the issue of whether there has been a violation of the provisions of this regulation. The investigation should include, in particular, the wind and sea conditions, the track and speed of the ship, other possible sources of the visible traces in the vicinity, and any relevant oil discharge records.
8. No discharge into the sea shall contain chemicals or other substances in quantities or concentrations which are hazardous to the marine environment or chemicals or other substances introduced for the purpose of circumventing the conditions of discharge specified in this regulation.
9. The oil residues which cannot be discharged into the sea in compliance with paragraphs 1 and 3 of this regulation shall be retained on board for subsequent discharge to reception facilities.

S Regulation 35 – Crude oil washing operations

1. Every oil tanker operating with crude oil washing systems shall be provided with an Operations and Equipment Manual²³ detailing the system and equipment and specifying operational procedures. Such a Manual shall be to the satisfaction of the Administration and shall contain all the information set out in the specifications referred to in paragraph 2 of regulation 33 of this Chapter.

²² Refer to regulation 38.6.

²³ Refer to the Standard format of the Crude Oil Washing Operation and Equipment Manual adopted by the Marine Environment Protection Committee of the Organization by resolution MEPC.3(XII), as amended by resolution MEPC.81(43).

If an alteration affecting the crude oil washing system is made, the Operations and Equipment Manual shall be revised accordingly.

2. With respect to the ballasting of cargo tanks, sufficient cargo tanks shall be crude oil washed prior to each ballast voyage in order that, taking into account the tanker's trading pattern and expected weather conditions, ballast water is put only into cargo tanks which have been crude oil washed.
3. Unless an oil tanker carries crude oil which is not suitable for crude oil washing, the oil tanker shall operate the crude oil washing system in accordance with the Operations and Equipment Manual.

S Regulation 36 – Oil Record Book, Part II – Cargo/ballast operations

1. Every oil tanker of 150 gross tonnage and above shall be provided with an Oil Record Book Part II (Cargo/Ballast Operations). The Oil Record Book Part II, whether as a part of the ship's official log-book or otherwise, shall be in the form specified in appendix III to this Chapter²⁴. *The record book shall be kept in accordance with the instructions provided in the record book.*
2. The Oil Record Book Part II shall be completed on each occasion, on a tank-to-tank basis if appropriate, whenever any of the following cargo/ballast operations take place in the ship:
 - 2.1. loading of oil cargo;
 - 2.2. internal transfer of oil cargo during voyage;
 - 2.3. unloading of oil cargo;
 - 2.4. ballasting of cargo tanks and dedicated clean ballast tanks;
 - 2.5. cleaning of cargo tanks including crude oil washing;
 - 2.6. discharge of ballast except from segregated ballast tanks;
 - 2.7. discharge of water from slop tanks;
 - 2.8. closing of all applicable valves or similar devices after slop tank discharge operations;
 - 2.9. closing of valves necessary for isolation of dedicated clean ballast tanks from cargo and stripping lines after slop tank discharge operations; and
 - 2.10. disposal of residues.
3. For oil tankers referred to in regulation 34.6 of this Chapter, the total quantity of oil and water used for washing and returned to a storage tank shall be recorded in the Oil Record Book Part II.
4. In the event of such discharge of oil or oily mixture as is referred to in regulation 4 of this Chapter or in the event of accidental or other exceptional discharge of oil not excepted by that regulation, a statement shall be made in the Oil Record Book Part II of the circumstances of, and the reasons for, the discharge.
5. Each operation described in paragraph 2 of this regulation shall be fully recorded without delay in the Oil Record Book Part II so that all entries in the book appropriate to that operation are completed. Each completed operation shall be signed by the officer or officers in charge of the operations concerned and each completed page shall be signed by the master of ship. The entries in the Oil Record Book Part II shall be at least in English, French or Spanish. Where entries in an official language of the State whose flag the ship is entitled to fly are also used, this shall prevail in case of dispute or discrepancy.
6. Any failure of the oil discharge monitoring and control system shall be noted in the Oil Record Book Part II.

²⁴ Refer to appendix III in MARPOL Annex I.

7. The Oil Record Book shall be kept in such a place as to be readily available for inspection at all reasonable times and, except in the case of unmanned ships under tow, shall be kept on board the ship. It shall be preserved for a period of three years after the last entry has been made.
8. The competent authority of the Government of a Party to the Convention may inspect the Oil Record Book Part II on board any ship to which this Chapter applies while the ship is in its port or offshore terminals and may make a copy of any entry in that book and may require the master of the ship to certify that the copy is a true copy of such entry. Any copy so made which has been certified by the master of the ship as a true copy of an entry in the ship's Oil Record Book Part II shall be made admissible in any judicial proceedings as evidence of the facts stated in the entry. The inspection of an Oil Record Book Part II and the taking of a certified copy by the competent authority under this paragraph shall be performed as expeditiously as possible without causing the ship to be unduly delayed.
9. For oil tankers of less than 150 gross tonnage operating in accordance with regulation 34.6 of this Chapter, an appropriate Oil Record Book should be developed by the Administration.
10. *The record books in question shall be kept in legible writing and pages may not be torn out. Entries that have been made, may not be erased, crossed out or made illegible in any other way. Should it be necessary to make alterations in the record book, they shall be in the form of remarks.*

Part V – Prevention of pollution arising from an oil pollution incident

S Regulation 37 – Shipboard oil pollution emergency plan

1. Every oil tanker of 150 gross tonnage and above and every ship other than an oil tanker of 400 gross tonnage and above shall carry on board a shipboard oil pollution emergency plan approved by the Administration.
2. Such a plan shall be prepared based on guidelines²⁵ developed by the Organization and written in the working language of the master and officers. The plan shall consist at least of:
 - 2.1. the procedure to be followed by the master or other persons having charge of the ship to report an oil pollution incident, as required in article 8 and Protocol I of the present Convention, based on the guidelines developed by the Organization;²⁶
 - 2.2. the list of authorities or persons to be contacted in the event of an oil pollution incident;
 - 2.3. a detailed description of the action to be taken immediately by persons on board to reduce or control the discharge of oil following the incident; and
 - 2.4. the procedures and point of contact on the ship for coordinating shipboard action with national and local authorities in combating the pollution.
3. In the case of ships to which regulation 17 of Chapter XXII applies, such a plan may be combined with the shipboard marine pollution emergency plan for noxious liquid substances required under regulation 17 of Chapter XXII. In this case, the title of such a plan shall be "Shipboard marine pollution emergency plan".

²⁵ Refer to the Guidelines for the development of shipboard oil pollution emergency plans adopted by the Organization by resolution MEPC.54(32), as amended by resolution MEPC.86(44).

²⁶ Refer to the General principles for ship reporting systems and ship reporting requirements, including guidelines for reporting incidents involving dangerous goods, harmful substances and/or marine pollutants adopted by the Organization by resolution A.851(20).

4. All oil tankers of 5,000 tonnes deadweight or more shall have prompt access to computerized shore-based damage stability and residual structural strength calculation programs.

Part VI – Reception facilities

M Regulation 38 – Reception facilities

Attention is drawn to the fact that the following regulation is the Danish Maritime Authority's translation of MARPOL. As regards Danish legislation, reference is made to the Ministry of the Environment.

A – Reception facilities outside special areas

1. The Government of each Party to the MARPOL Convention undertakes to ensure the provision at oil loading terminals, repair ports, and in other ports in which ships have oily residues to discharge, of facilities for the reception of such residues and oily mixtures as remain from oil tankers and other ships adequate²⁷ to meet the needs of the ships using them without causing undue delay to ships.
2. Reception facilities in accordance with paragraph 1 of this regulation shall be provided in:
 - 2.1. all ports and terminals in which crude oil is loaded into oil tankers where such tankers have immediately prior to arrival completed a ballast voyage of not more than 72 hours or not more than 1200 nautical miles;
 - 2.2. all ports and terminals in which oil other than crude oil in bulk is loaded at an average quantity of more than 1000 tonnes per day;
 - 2.3. all ports having ship repair yards or tank cleaning facilities;
 - 2.4. all ports and terminals which handle ships provided with the oil residue (sludge) tank(s) required by regulation 12 of this Chapter;
 - 2.5. all ports in respect of oily bilge waters and other residues that cannot be discharged in accordance with regulation 15 and 34 of this Chapter; and
 - 2.6. all loading ports for bulk cargoes in respect of oil residues from combination carriers which cannot be discharged in accordance with regulation 34 of this Chapter.
3. The capacity for the reception facilities shall be as follows:
 - 3.1. Crude oil loading terminals shall have sufficient reception facilities to receive oil and oily mixtures which cannot be discharged in accordance with the provisions of regulation 34.1 of this Chapter from all oil tankers on voyages as described in paragraph 2.1 of this regulation.
 - 3.2. Loading ports and terminals referred to in paragraph 2.2 of this regulation shall have sufficient reception facilities to receive oil and oily mixtures which cannot be discharged in accordance with the provisions of regulation 34.1 of this Chapter from oil tankers which load oil other than crude oil in bulk.
 - 3.3. All ports having ship repair yards or tank cleaning facilities shall have sufficient reception facilities to receive all residues and oily mixtures which remain on board for disposal from ships prior to entering such yards or facilities.
 - 3.4. All facilities provided in ports and terminals under paragraph 2.4 of this regulation shall be sufficient to receive all residues retained according to regulation 12 of this Chapter from all ships that may reasonably be expected to call at such ports and terminals.

²⁷ See resolution MEPC.83(44), "Guidelines for ensuring the adequacy of port waste reception facilities".

- 3.5. All facilities provided in ports and terminals under this regulation shall be sufficient to receive oily bilge waters and other residues which cannot be discharged in accordance with regulation 15 of this Chapter.
- 3.6. The facilities provided in loading ports for bulk cargoes shall take into account the special problems of combination carriers as appropriate.

B – Reception facilities within special areas

4. The Government of each Party to the MARPOL Convention the coastline of which borders on any given special area shall ensure that all oil loading terminals and repair ports within the special area are provided with facilities adequate for the reception and treatment of all the dirty ballast and tank washing water from oil tankers. In addition, all ports within the special area shall be provided with adequate²⁸ reception facilities for other residues and oily mixtures from all ships. Such facilities shall have adequate capacity to meet the needs of the ships using them without causing undue delay.
5. The Government of each Party to the MARPOL Convention having under its jurisdiction entrances to seawater courses with low depth contour which might require a reduction of draught by the discharge of ballast shall ensure the provision of the facilities referred to in paragraph 4 of this regulation but with the proviso that ships required to discharge slops or dirty ballast could be subject to some delay.
6. With regard to the Red Sea area, Gulfs area, Gulf of Aden area and Oman area of the Arabian Sea:
 - 6.1. Each Party concerned shall notify the Organization of the measures taken pursuant to provisions of paragraphs 4 and 5 of this regulation. Upon receipt of sufficient notifications, the Organization shall establish a date from which the discharge requirements of regulations 15 and 34 of this Chapter in respect of the area in question shall take effect. The Organization shall notify all Parties of the date so established no less than twelve months in advance of that date.
 - 6.2. During the period between the entry into force of the present Convention and the date so established, ships while navigating in the special area shall comply with the requirements of regulations 15 and 34 of this Chapter as regards discharges outside special areas.
 - 6.3. After such date, oil tankers loading in ports in these special areas where such facilities are not yet available shall also fully comply with the requirements of regulations 15 and 34 of this Chapter as regards discharges within special areas. However, oil tankers entering these special areas for the purpose of loading shall make every effort to enter the area with only clean ballast on board.
 - 6.4. After the date on which the requirements for the special area in question take effect, each Party shall notify the Organization for transmission to the Parties concerned of all cases where the facilities are alleged to be inadequate.
 - 6.5. At least the reception facilities as prescribed in paragraphs 1, 2 and 3 of this regulation shall be provided one year after the date of entry into force of the MARPOL Convention.
7. Notwithstanding paragraphs 4, 5 and 6 of this regulation, the following rules apply to the Antarctic area:
 - 7.1. The Government of each Party to the MARPOL Convention at whose ports ships depart en route to or arrive from the Antarctic area undertakes to ensure that as soon as practicable adequate facilities are provided for the reception of all oil residue (sludge), dirty ballast, tank

²⁸ See resolution MEPC.83(44), "Guidelines for ensuring the adequacy of port waste reception facilities".

washing water, and other oily residues and mixtures from all ships, without causing undue delay, and according to the needs of the ships using them.

- 7.2. The Government of each Party to the present Convention shall ensure that all ships entitled to fly its flag, before entering the Antarctic area, are fitted with a tank or tanks of sufficient capacity on board for the retention of all oil residue (sludge), dirty ballast, tank washing water and other oily residues and mixtures while operating in the area and have concluded arrangements to discharge such oily residues at a reception facility after leaving the area.

C – General requirements

8. Each Party shall notify the Organization for transmission to the Parties concerned of all cases where the facilities provided under this regulation are alleged to be inadequate.

Part VII – Special requirements for fixed or floating platforms

S Regulation 39 – Special requirements for fixed or floating platforms

1. This regulation applies to fixed or floating platforms including drilling rigs, floating production, storage and offloading facilities (FPSOs) used for the offshore production and storage of oil, and floating storage units (FSUs) used for the offshore storage of produced oil.
2. Fixed or floating platforms when engaged in the exploration, exploitation and associated offshore processing of sea-bed mineral resources and other platforms shall comply with the requirements of this Chapter applicable to ships of 400 gross tonnage and above other than oil tankers, except that:
 - 2.1. they shall be equipped as far as practicable with the installations required in regulations 12 and 14 of this Chapter;
 - 2.2. they shall keep a record of all operations involving oil or oily mixture discharges, in a form approved by the Administration; and
 - 2.3. subject to the provisions of regulation 4 of this Chapter, the discharge into the sea of oil or oily mixture shall be prohibited except when the oil content of the discharge without dilution does not exceed 15 parts per million.
3. In verifying compliance with this Chapter in relation to platforms configured as FPSOs or FSUs, in addition to the requirements of paragraph 2, Administrations should take account of the Guidelines developed by the Organization.²⁹

²⁹ Refer to resolution MEPC.139(53), as amended, "Guidelines for the application of the revised MARPOL Annex I requirements to FPSOs FSUs."

Appendix I

List of oils³⁰

Asphalt solutions	Gas Oil
Blending stocks	Cracked
Roofers flux	
Straight run residue	Gasoline Blending stocks
	Alkylates – fuel
Oils	Reformats
Clarified	Polymer – fuel
Crude oil	
Mixtures containing crude oil	Gasolines
Diesel oil	Casinghead (natural)
Fuel oil no. 4	Automotive
Fuel oil no. 5	Aviation
Fuel oil no. 6	Straight run
Residual fuel oil	Fuel oil no. 1 (kerosene)
Road oil	Fuel oil no. 1-D
Transformer oil	Fuel oil no. 2
Aromatic oil (excluding vegetable oil)	
Lubricating oils and blending	Jet fuels
Stocks	JP-1 (kerosene)
Mineral oil	JP-3
Motor oil	JP-4
Penetrating oil	JP-5 (kerosene, heavy)
Spindle oil	Turbo fuel
Turbine oil	Kerosene
	Mineral spirit
Distillates	
Straight run	Naphtha
Flashed feed stocks	Solvent
	Petroleum
	Heartcut distillate oil

³⁰ This list of oils shall not necessarily be considered as comprehensive.

Appendix II

Form of IOPP Certificate and Supplements

Reference is made to Chapter 1 C of Notice B.

Appendix III:

Form of Oil Record Book

Reference is made to Appendix 3 of MARPOL, Annex I, and to the Oil Record Book, Parts 1 and 2, published by the publishing company Weilbach.

Notice from the Danish Maritime Authority B – The Construction and Equipment, etc. of Ships

Chapter B XXII

Control of noxious liquid substances and other substances in bulk

Regulation 1 – Definitions	2
Regulation 2 – Application	4
S Regulation 3 – Exceptions	4
S Regulation 4 – Exemptions.....	4
S Regulation 5 – Equivalentents	6
M Regulation 6 – Categorization and listing of noxious liquid substances and other substances.....	7
S Regulation 7 – Survey and certification of chemical tankers	8
S Regulation 8 – Surveys	8
S Regulation 9 – Issue or endorsement of Certificate.....	10
S Regulation 10 – Duration and validity of Certificate	11
S Regulation 11 – Design, construction, equipment and operations	12
S Regulation 12 – Pumping, piping, unloading arrangements and slop tanks.....	13
M Regulation 13 – Operational discharges of noxious liquid substances	14
S Regulation 14 – Procedures and Arrangements Manual	17
Regulation 15 – Cargo Record Book	18
S Regulation 16 – Measures of control.....	18
S Regulation 17 – Shipboard marine pollution emergency plan for noxious liquid substances.....	20
M Regulation 18 – Reception facilities and cargo unloading terminal arrangements	21

Introduction

The provisions of chapter XXII have been drawn up on the basis of annex II to the International Convention for the Prevention of Pollution from Ships – the 1973 MARPOL Convention – with the amendments and additions contained in the 1978 Protocol to MARPOL 1973, as amended.

The administration of the rules has been distributed so that the Danish Environmental Protection Agency is responsible for the rules on discharge, and the Danish Maritime Authority is responsible for the rules on the technical installations on board the ships, including certificates, records and plans. This distribution of responsibility has been indicated in the table of contents with an “M” for the Danish Environmental Protection Agency and an “S” for the Danish Maritime Authority.

In connection with the implementation of the provisions of the MARPOL Convention in Denmark, orders have been issued by the Danish Ministry of the Environment, which must be observed as well, in addition to the technical regulations contained in the sets of regulations issued by the Danish Maritime Authority.

In these provisions, the IMO is referred to as the Organisation, MARPOL 73/78 is referred to as the Convention, and the Danish Environmental Protection Agency and the Danish Maritime Authority, respectively, are referred to as the Administration.

Part 1 – General

Regulation 1 – Definitions

For the purposes of this Chapter:

- 1 “Anniversary date” means the day and the month of each year which will correspond to the date of expiry of the International Pollution Prevention Certificate for the Carriage of Noxious Liquid Substances in Bulk.
- 2 “Associated piping” means the pipeline from the suction point in a cargo tank to the shore connection used for unloading the cargo and includes all ship’s piping, pumps and filters which are in open connection with the cargo unloading line.
- 3 Ballast water
“Clean ballast” means ballast water carried in a tank which, since it was last used to carry a cargo containing a substance in category X, Y or Z, has been thoroughly cleaned and the residues resulting therefrom have been discharged and the tank emptied in accordance with the appropriate requirements of this Chapter.

“Segregated ballast” means ballast water introduced into a tank permanently allocated to the carriage of ballast or cargoes other than oil or noxious liquid substances as variously defined in the present Convention, and which is completely separated from the cargo and oil fuel system.
- 4 Chemical Codes
“Bulk Chemical Code” means the Code for the Construction and Equipment of Ships carrying Dangerous Chemicals in Bulk adopted by the Marine Environment Protection Committee of the Organization by resolution MEPC.20(22), as amended by the Organization, provided that such amendments are adopted and brought into force in accordance with the provisions of article 16 of the present Convention concerning amendment procedures applicable to an appendix to an Chapter.

“International Bulk Chemical Code” means the International Code for the Construction and Equipment of Ships Carrying Dangerous Chemicals in Bulk adopted by the Marine Environment Protection Committee of the Organization by resolution MEPC.19(22), as amended by the Organization, provided that such amendments are adopted and brought into force in accordance with the provisions of article 16 of the present Convention concerning amendment procedures applicable to an appendix to an Chapter.
- 5 “Depth of water” means the charted depth.
- 6 “En route” means that the ship is under way at sea on a course or courses, including deviation from the shortest direct route, which as far as practicable for navigational purposes, will cause any discharge to be spread over as great an area of the sea as is reasonable and practicable.
- 7 “Liquid substances” are those having a vapour pressure not exceeding 0.28 MPa absolute at a temperature of 37.8°C.

- 8 “Manual” means Procedures and Arrangements Manual in accordance with the model given in appendix 6 of this Chapter.¹⁾
- 9 “Nearest land”. The term “from the nearest land” means from the baseline from which the territorial sea in question is established in accordance with international law, except that, for the purposes of the present Convention “from the nearest land” off the north-eastern coast of Australia shall mean from the line drawn from a point on the coast of Australia in:
 latitude 11°00’ S, longitude 142°08’ E
 to a point in latitude 10°35’ S, longitude 141°55’ E,
 thence to a point latitude 10°00’ S, longitude 142° 00’ E,
 thence to a point latitude 09°10’ S, longitude 143° 52’ E,
 thence to a point latitude 09°00’ S, longitude 144° 30’ E,
 thence to a point latitude 10°41’ S, longitude 145° 00’ E,
 thence to a point latitude 13°00’ S, longitude 145° 00’ E,
 thence to a point latitude 15°00’ S, longitude 146° 00’ E,
 thence to a point latitude 17°30’ S, longitude 147° 00’ E,
 thence to a point latitude 21°00’ S, longitude 152° 55’ E,
 thence to a point latitude 24°30’ S, longitude 154° 00’ E,
 thence to a point on the coast of Australia in latitude 24°42’ S, longitude 153°15’ E.
- 10 “Noxious liquid substance” means any substance indicated in the Pollution Category column of chapter 17 or 18 of the International Bulk Chemical Code or provisionally assessed under the provisions of regulation 6.3 as falling into category X, Y or Z.
- 11 ppm means ml/m³.
- 12 “Residue” means any noxious liquid substance which remains for disposal.
- 13 “Residue/water mixture” means residue to which water has been added for any purpose (e.g. tank cleaning, ballasting, bilge slops).
- 14 “Ship construction”
- 14.1 “Ship constructed” means a ship the keel of which is laid or which is at a similar stage of construction. A ship converted to a chemical tanker, irrespective of the date of construction, shall be treated as a chemical tanker constructed on the date on which such conversion commenced. This conversion provision shall not apply to the modification of a ship which complies with all of the following conditions:
- 14.1.1 the ship is constructed before 1 July 1986; and
- 14.1.2 the ship is certified under the “Bulk Chemical Code” to carry only those products identified by the Code as substances with pollution hazards only.
- 14.2 “Similar stage of construction” means the stage at which:
- 14.2.1 construction identifiable with a specific ship begins; and
- 14.2.2 assembly of that ship has commenced comprising at least 50 tonnes or one per cent of the estimated mass of all structural material, whichever is less.
- 15 “Solidifying/non-solidifying”
- 15.1 “Solidifying substance” means a noxious liquid substance which:
- 15.1.1 in the case of a substance with a melting point of less than 15°C, is at a temperature of less than 5°C above its melting point at the time of unloading; or

¹⁾ Please refer to Appendix 6 of MARPOL Annex II.

15.1.2 in the case of a substance with a melting point of equal to or greater than 15°C, is at a temperature of less than 10°C above its melting point at the time of unloading.

15.2 “Non-solidifying substance” means a noxious liquid substance, which is not a solidifying substance.

16 “Tanker”

16.1 “Chemical tanker” means a ship constructed or adapted for the carriage in bulk of any liquid product listed in chapter 17 of the International Bulk Chemical Code.

16.2 “NLS tanker” means a ship constructed or adapted to carry a cargo of noxious liquid substances in bulk and includes an “oil tanker” as defined in chapter XXI, when certified to carry a cargo or part cargo of noxious liquid substances in bulk.

17 “Viscosity”

17.1 “High-viscosity substance” means a noxious liquid substance in category X or Y with a viscosity equal to or greater than 50 mPa·s at the unloading temperature.

17.2 “Low-viscosity substance” means a noxious liquid substance which is not a high-viscosity substance.

Regulation 2 – Application

- 1 Unless expressly provided otherwise, the provisions of this Chapter shall apply to all ships certified to carry noxious liquid substances in bulk.
- 2 Where a cargo subject to the provisions of chapter XXI, is carried in a cargo space of an NLS tanker, the appropriate requirements of chapter XXI shall also apply.

S Regulation 3 – Exceptions

- 1 The discharge requirements of this Chapter shall not apply to the discharge into the sea of noxious liquid substances or mixtures containing such substances when such a discharge:
 - 1.1 is necessary for the purpose of securing the safety of a ship or saving life at sea; or
 - 1.2 results from damage to a ship or its equipment:
 - 1.2.1 provided that all reasonable precautions have been taken after the occurrence of the damage or discovery of the discharge for the purpose of preventing or minimizing the discharge; and
 - 1.2.2 except if the owner or the master acted either with intent to cause damage, or recklessly and with knowledge that damage would probably result; or
 - 1.3 is approved by the Administration, when being used for the purpose of combating specific pollution incidents in order to minimize the damage from pollution. Any such discharge shall be subject to the approval of any Government in whose jurisdiction it is contemplated the discharge will occur.

S Regulation 4 – Exemptions

- 1 With respect to amendments to carriage requirements due to the upgrading of the categorization of a substance, the following shall apply:
 - 1.1 where an amendment to this Chapter and the International Bulk Chemical Code and Bulk Chemical Code involves changes to the structure or equipment and fittings due to the upgrading of the requirements for the carriage of certain substances, the Administration may modify or delay for a specified period the application of such an amendment to ships

constructed before the date of entry into force of that amendment, if the immediate application of such an amendment is considered unreasonable or impracticable. Such relaxation shall be determined with respect to each substance;

- 1.2 the Administration allowing a relaxation of the application of an amendment under this paragraph shall submit to the organization a report giving details of the ship or ships concerned, the cargoes certified to carry, the trade in which each ship is engaged and the justification for the relaxation, for circulation to the Parties to the Convention for their information and appropriate action, if any, and reflect the exemption on the Certificate as referred to in regulation 7 or 9;
 - 1.3 Notwithstanding the above, an Administration may exempt ships from the carriage requirements under regulation 11 for ships certified to carry individually identified vegetable oils identified by the relevant footnote in chapter 17 of the IBC Code, provided the ship complies with the following conditions:
 - 1.3.1 subject to this regulation, the NLS tanker shall meet all requirements for ship type 3 as identified in the IBC Code except for cargo tank location;
 - 1.3.2 under this regulation, cargo tanks shall be located at the following distances inboard. The entire cargo tank length shall be protected by ballast tanks or spaces other than tanks that carry oil as follows:
 - 1.3.2.1 wing tanks or spaces shall be arranged such that cargo tanks are located inboard of the moulded line of the side shell plating nowhere less than 760 mm;
 - 1.3.2.2 double bottom tanks or spaces shall be arranged such that the distance between the bottom of the cargo tanks and the moulded line of the bottom shell plating measured at right angles to the bottom shell plating is not less than $B/15$ (m) or 2.0 m at the centreline, whichever is the lesser. The minimum distance shall be 1.0 m;
 - 1.3.2.3 the relevant certificate shall indicate the exemption granted.
- 2 Subject to the provisions of paragraph 3 of this regulation, the provisions of regulation 12.1 need not apply to a ship constructed before 1 July 1986 which is engaged in restricted voyages as determined by the Administration between:
 - 2.1 ports or terminals within a State Party to the present Convention; or
 - 2.2 ports or terminals of States Parties to the present Convention.
 - 3 The provisions of paragraph 2 of this regulation shall only apply to a ship constructed before 1 July 1986 if:
 - 3.1 each time a tank containing category X, Y or Z substances or mixtures is to be washed or ballasted, the tank is washed in accordance with a prewash procedure approved by the Administration in compliance with appendix 6 of this Chapter²⁾, and the tank washings are discharged to a reception facility;
 - 3.2 subsequent washings or ballast water are discharged to a reception facility or at sea in accordance with other provisions of this Chapter;
 - 3.3 the adequacy of the reception facilities at the ports or terminals referred to above, for the purpose of this paragraph, is approved by the Governments of the States Parties to the present Convention within which such ports or terminals are situated;

²⁾ Please refer to Appendix 6 of MARPOL Annex II.

- 3.4 in the case of ships engaged in voyages to ports or terminals under the jurisdiction of other States Parties to the present Convention, the Administration communicates to the Organization, for circulation to the Parties to the Convention, particulars of the exemption, for their information and appropriate action, if any; and
 - 3.5 the certificate required under this Chapter is endorsed to the effect that the ship is solely engaged in such restricted voyages.
- 4 For a ship whose constructional and operational features are such that ballasting of cargo tanks is not required and cargo tank washing is only required for repair or dry-docking, the Administration may allow exemption from the provisions of regulation 12, provided that all of the following conditions are complied with:
- 4.1 the design, construction and equipment of the ship are approved by the Administration, having regard to the service for which it is intended;
 - 4.2 any effluent from tank washings which may be carried out before a repair or dry-docking is discharged to a reception facility, the adequacy of which is ascertained by the Administration;
 - 4.3 the certificate required under this Chapter indicates:
 - 4.3.1 that each cargo tank is certified for the carriage of a restricted number of substances which are comparable and can be carried alternately in the same tank without intermediate cleaning; and
 - 4.3.2 the particulars of the exemption;
 - 4.4 the ship carries a Manual approved by the Administration; and
 - 4.5 in the case of ships engaged in voyages to ports or terminals under the jurisdiction of other States Parties to the present Convention, the Administration communicates to the organization, for circulation to the Parties to the Convention, particulars of the exemption, for their information and appropriate action, if any.

S Regulation 5 – Equivalents

- 1 The Administration may allow any fitting, material, appliance or apparatus to be fitted in a ship as an alternative to that required by this Chapter if such fitting, material, appliance or apparatus is at least as effective as that required by this Chapter. This authority of the Administration shall not extend to the substitution of operational methods to effect the control of discharge of noxious liquid substances as equivalent to those design and construction features which are prescribed by regulations in this Chapter.
- 2 The Administration which allows a fitting, material, appliance or apparatus as alternative to that required by this Chapter, under paragraph 1 of this regulation, shall communicate to the Organization, for circulation to the Parties to the Convention, particulars thereof, for their information and appropriate action, if any.
- 3 Notwithstanding the provisions of paragraphs 1 and 2 of this regulation, the construction and equipment of liquefied gas carriers certified to carry noxious liquid substances listed in the applicable Gas Carrier Code, shall be deemed to be equivalent to the construction and equipment requirements contained in regulations 11 and 12 of this Chapter, provided that the gas carrier meets all following conditions:
 - 3.1 hold a Certificate of Fitness in accordance with the appropriate Gas Carrier Code for ships certified to carry liquefied gases in bulk;

- 3.2 hold an International Pollution Prevention Certificate for the Carriage of Noxious Liquid Substances in Bulk, in which it is certified that the gas carrier may carry only those noxious liquid substances identified and listed in the appropriate Gas Carrier Code;
- 3.3 be provided with segregated ballast arrangements;
- 3.4 be provided with pumping and piping arrangements which, to the satisfaction of the Administration, ensure that the quantity of cargo residue remaining in the tank and its associated piping after unloading does not exceed the applicable quantity of residue as required by regulation 12.1, 12.2 or 12.3; and
- 3.5 be provided with a Manual, approved by the Administration, ensuring that no operational mixing of cargo residues and water will occur and that no cargo residues will remain in the tank after applying the ventilation procedures prescribed in the Manual.

Part 2 – Categorization of noxious liquid substances

M Regulation 6 – Categorization and listing of noxious liquid substances and other substances

Attention is drawn to the fact that the following regulation is the Danish Maritime Authority's translation of MARPOL. As regards Danish legislation, reference is made to Consolidated Act no. 925 of 28 September 2005 on protection of the marine environment, chapter 3, and Order no. 166 of 1 April 1987 on classification and categorisation as well as discharge of liquid substances carried in bulk.

- 1 For the purpose of the regulations of this Chapter, noxious liquid substances shall be divided into four categories as follows:
 - 1.1 Category X: Noxious liquid substances which, if discharged into the sea from tank cleaning or deballasting operations, are deemed to present a major hazard to either marine resources or human health and, therefore, justify the prohibition of the discharge into the marine environment;
 - 1.2 Category Y: Noxious liquid substances which, if discharged into the sea from tank cleaning or deballasting operations, are deemed to present a hazard to either marine resources or human health or cause harm to amenities or other legitimate uses of the sea and therefore justify a limitation on the quality and quantity of the discharge into the marine environment;
 - 1.3 Category Z: Noxious liquid substances which, if discharged into the sea from tank cleaning or deballasting operations, are deemed to present a minor hazard to either marine resources or human health and therefore justify less stringent restrictions on the quality and quantity of the discharge into the marine environment;
 - 1.4 Other substances: Substances indicated as OS (Other substances) in the pollution category column of chapter 18 of the International Bulk Chemical Code which have been evaluated and found to fall outside category X, Y or Z as defined in regulation 6.1 of this Chapter because they are, at present, considered to present no harm to marine resources, human health, amenities or other legitimate uses of the sea when discharged into the sea from tank cleaning or deballasting operations. The discharge of bilge or ballast water or other residues or mixtures containing only substances referred to as "Other Substances" shall not be subject to any requirements of the Chapter.

- 2 Guidelines for use in the categorization of noxious liquid substances are given in appendix 1 to this Chapter.³⁾
- 3 Where it is proposed to carry a liquid substance in bulk which has not been categorized under paragraph 1 of this regulation, the Governments of Parties to the Convention involved in the proposed operation shall establish and agree on a provisional assessment for the proposed operation on the basis of the guidelines referred to in paragraph 2 of this regulation. Until full agreement among the Governments involved has been reached, the substance shall not be carried. As soon as possible, but not later than 30 days after the agreement has been reached, the Government of the producing or shipping country, initiating the agreement concerned, shall notify the Organization and provide details of the substance and the provisional assessment for annual circulation to all Parties for their information. The Organization shall maintain a register of all such substances and their provisional assessment until such time as the substances are formally included in the IBC Code.

Part 3 – Survey and certificates

S Regulation 7 – Survey and certification of chemical tankers

- 1 Notwithstanding the provisions of regulations 8, 9, and 10 of this Chapter, chemical tankers which have been surveyed and certified by States Parties to the present Convention in accordance with the provisions of the International Bulk Chemical Code or the Bulk Chemical Code, as applicable, shall be deemed to have complied with the provisions of the said regulations, and the certificate issued under that Code shall have the same force and receive the same recognition as the certificate issued under regulation 9.

S Regulation 8 – Surveys

- 1 Ships carrying noxious liquid substances in bulk shall be subject to the surveys specified below:
 - 1.1 An initial survey before the ship is put in service or before the Certificate required under regulation 9 is issued for the first time, and which shall include a complete survey of its structure, equipment, systems, fittings, arrangements and material in so far as the ship is covered by this Chapter. This survey shall be such as to ensure that the structure, equipment, systems, fittings, arrangements and material fully comply with the applicable requirements of this Chapter.
 - 1.2 A renewal survey at intervals specified by the Administration, but not exceeding 5 years, except where regulation 10.2, 10.5, 10.6, or 10.7 is applicable. The renewal survey shall be such as to ensure that the structure, equipment, systems, fittings, arrangements and material fully comply with applicable requirements of this Chapter.
 - 1.3 An intermediate survey within 3 months before or after the second anniversary date or within 3 months before or after the third anniversary date of the Certificate which shall take the place of one of the annual surveys specified in paragraph 1.4 of this regulation. The intermediate survey shall be such as to ensure that the equipment and associated pump and piping systems fully comply with the applicable requirements of this Chapter and are in good working order. Such intermediate surveys shall be endorsed on the Certificate issued under regulation 9 of this Chapter.

³⁾ Please refer to Appendix I of MARPOL Annex II.

- 1.4 An annual survey within 3 months before or after each anniversary date of the Certificate including a general inspection of the structure, equipment, systems, fittings, arrangements and material referred to in paragraph 1.1 of this regulation to ensure that they have been maintained in accordance with paragraph 3 of this regulation and that they remain satisfactory for the service for which the ship is intended. Such annual surveys shall be endorsed on the Certificate issued under regulation 9.
- 1.5 An additional survey either general or partial, according to the circumstances, shall be made after a repair resulting from investigations prescribed in paragraph 3 of this regulation⁴⁾, or whenever any important repairs or renewals are made. The survey shall be such as to ensure that the necessary repairs or renewals have been effectively made, that the material and workmanship of such repairs or renewals are in all respects satisfactory and that the ship complies in all respects with the requirements of this Chapter.

2

- 2.1 Surveys of ships, as regards the enforcement of the provisions of this Chapter, shall be carried out by officers of the Administration. The Administration may, however, entrust the surveys either to surveyors nominated for the purpose or to organizations recognized by it.
- 2.2 The recognized organization, referred to in paragraph 2.1 of this regulation, shall comply with the Guidelines adopted by the Organization by resolution A.739(18), as may be amended by the Organization, and the specification adopted by the Organization by resolution A.789(19), as may be amended by the Organization, provided that such amendments are adopted, brought into force and take effect in accordance with the provisions of article 16 of the present Convention concerning the amendment procedures applicable to this Chapter.
- 2.3 An Administration nominating surveyors or recognizing organizations to conduct surveys as set forth in paragraph 2.1 of this regulation shall, as a minimum, empower any nominated surveyor or recognized organization to:
 - 2.3.1 require repairs to a ship; and
 - 2.3.2 carry out surveys if requested by the appropriate authorities of a port State.
- 2.4 The Administration shall notify the Organization of the specific responsibilities and conditions of the authority delegated to the nominated surveyors or recognized organizations, for circulation to Parties to the present Convention for the information of their officers.
- 2.5 When a nominated surveyor or recognized organization determines that the condition of the ship or its equipment does not correspond substantially with the particulars of the Certificate, or is such that the ship is not fit to proceed to sea without presenting an unreasonable threat of harm to the marine environment, such surveyor or organization shall immediately ensure that corrective action is taken and shall in due course notify the Administration. If such corrective action is not taken the Certificate should be withdrawn and the Administration shall be notified immediately, and if the ship is in a port of another Party, the appropriate authorities of the port State shall also be notified immediately. When an officer of the Administration, a nominated surveyor or a recognized organization has notified the appropriate authorities of the port State, the Government of the port State concerned shall give such officer, surveyor or organization any necessary assistance to carry out their

⁴⁾ Please refer to appendix 1C of Notice for the Danish Maritime Authority B.

obligations under this regulation. When applicable, the Government of the port State concerned shall take such steps as will ensure that the ship shall not sail until it can proceed to sea or leave the port for the purpose of proceeding to the nearest appropriate repair yard available without presenting an unreasonable threat of harm to the marine environment.

2.6 In every case, the Administration concerned shall fully guarantee the completeness and efficiency of the survey and shall undertake to ensure the necessary arrangements to satisfy this obligation.

3

3.1 The condition of the ship and its equipment shall be maintained to conform with the provisions of the present Convention to ensure that the ship in all respects will remain fit to proceed to sea without presenting an unreasonable threat of harm to the marine environment.

3.2 After any survey of the ship required under paragraph 1 of this regulation has been completed, no change shall be made in the structure, equipment, systems, fittings, arrangements or material covered by the survey, without the sanction of the Administration, except the direct replacement of such equipment and fittings.

3.3 Whenever an accident occurs to a ship or a defect is discovered which substantially affects the integrity of the ship or the efficiency or completeness of its equipment covered by this Chapter, the master or owner of the ship shall report at the earliest opportunity to the Administration, the recognized organization or the nominated surveyor responsible for issuing the relevant Certificate, who shall cause investigations to be initiated to determine whether a survey as required by paragraph 1 of this regulation is necessary. If the ship is in a port of another Party, the master or owner shall also report immediately to the appropriate authorities of the port State and the nominated surveyor or recognized organization shall ascertain that such report has been made.

S Regulation 9 – Issue or endorsement of Certificate

1 An International Pollution Prevention Certificate for the Carriage of Noxious Liquid Substances in Bulk shall be issued, after an initial or renewal survey in accordance with the provisions of regulation 8, to any ship intended to carry noxious liquid substances in bulk and which is engaged in voyages to ports or terminals under the jurisdiction of other Parties to the Convention.

2 Such Certificate shall be issued or endorsed either by the Administration or by any person or organization duly authorized by it. In every case, the Administration assumes full responsibility for the Certificate.

3

3.1 The Government of a Party to the Convention may, at the request of the Administration, cause a ship to be surveyed and, if satisfied that the provisions of this Chapter are complied with, shall issue or authorize the issue of an International Pollution Prevention Certificate for the Carriage of Noxious Liquid Substances in Bulk to the ship and, where appropriate, endorse or authorize the endorsement of that Certificate on the ship, in accordance with this Chapter.

3.2 A copy of the Certificate and a copy of the survey report shall be transmitted as soon as possible to the requesting Administration.

- 3.3 A Certificate so issued shall contain a statement to the effect that it as been issued at the request of the Administration and it shall have the same force and receive the same recognition as the Certificate issued under paragraph 1 of this regulation.
- 3.4 No International Pollution Prevention Certificate for the Carriage of Noxious Liquid Substances in Bulk shall be issued to a ship which is entitled to fly the flag of a State which is not a party.
- 4 The International Pollution Prevention Certificate for the Carriage of Noxious Liquid Substances in Bulk shall be drawn up in the form corresponding to the model given in appendix 3 to this Chapter and shall be at least in English, French or Spanish. Where entries in an official national language of the State whose flag the ship is entitled to fly are also used, this shall prevail in the case of a dispute or discrepancy.

S Regulation 10 – Duration and validity of Certificate

- 1 An International Pollution Prevention Certificate for the Carriage of Noxious Liquid Substances in Bulk shall be issued for a period specified by the Administration which shall not exceed 5 years.
 - 2
 - 2.1 Notwithstanding the requirements of paragraph 1 of this regulation, when the renewal survey is completed within 3 months before the expiry date of the existing Certificate, the new Certificate shall be valid from the date of completion of the renewal survey to a date not exceeding 5 years from the date of expiry of the existing Certificate.
 - 2.2 When the renewal survey is completed after the expiry date of the existing Certificate, the new Certificate shall be valid from the date of completion of the renewal survey to a date not exceeding 5 years from the date of expiry of the existing Certificate.
 - 2.3 When the renewal survey is completed more than 3 months before the expiry date of the existing Certificate, the new Certificate shall be valid from the date of completion of the renewal survey to a date not exceeding 5 years from the date of completion of the renewal survey.
 - 3 If a Certificate is issued for a period of less than 5 years, the Administration may extend the validity of the Certificate beyond the expiry date to the maximum period specified in paragraph 1 of this regulation, provided that the surveys referred to in regulation 8.1.3 and 8.1.4 of this Chapter applicable when a Certificate is issued for a period of 5 years are carried out as appropriate.
 - 4 If a renewal survey has been completed and a new Certificate cannot be issued or placed on board the ship before the expiry date of the existing Certificate, the person or organization authorized by the Administration may endorse the existing Certificate and such a Certificate shall be accepted as valid for a further period which shall not exceed 5 months from the expiry date.
 - 5 If a ship at the time when a Certificate expires is not in a port in which it is to be surveyed, the Administration may extend the period of validity of the Certificate but this extension shall be granted only for the purpose of allowing the ship to complete its voyage to the port in which it is to be surveyed, and then only in cases where it appears proper and reasonable to do so. No Certificates shall be extended for a period longer than 3 months, and a ship to which an extension is granted shall not, on its arrival in the port in which it is to be surveyed, be entitled by virtue of such extension to leave that port without having a new Certificate. When the renewal survey is completed, the new Certificate shall be valid to a date not exceeding 5 years from the date of expiry of the existing Certificate before the extension was granted.

- 6 A Certificate issued to a ship engaged on short voyages which has not been extended under the foregoing provisions of this regulation may be extended by the Administration for a period of grace of up to one month from the date of expiry stated on it. When the renewal survey is completed, the new Certificate shall be valid to a date not exceeding 5 years from the date of expiry of the existing Certificate before the extension was granted.
- 7 In special circumstances, as determined by the Administration, a new Certificate need not be dated from the date of expiry of the existing Certificate as required by paragraph 2.2, 5 or 6 of this regulation. In these special circumstances, the new Certificate shall be valid to a date not exceeding 5 years from the date of completion of the renewal survey.
- 8 If an annual or intermediate survey is completed before the period specified in regulation 8, then:
 - 8.1 the anniversary date shown on the Certificate shall be amended by endorsement to a date which shall not be more than 3 months later than the date on which the survey was completed;
 - 8.2 the subsequent annual or intermediate survey required by regulation 8, shall be completed at the intervals prescribed by that regulation using the new anniversary date;
 - 8.3 the expiry date may remain unchanged provided one or more annual or intermediate surveys, as appropriate, are carried out so that the maximum intervals between the surveys prescribed by regulation 8 are not exceeded.
- 9 A Certificate issued under regulation 9 shall cease to be valid in any of the following cases:
 - 9.1 if the relevant surveys are not completed within the periods specified under regulation 8.1;
 - 9.2 if the Certificate is not endorsed in accordance with regulation 8.1.3 or 8.1.4;
 - 9.3 upon transfer of the ship to the flag of another State. A new Certificate shall only be issued when the Government issuing the new Certificate is fully satisfied that the ship is in compliance with the requirements of regulation 8.3.1 and 8.3.2. In the case of a transfer between Parties, if requested within 3 months after the transfer has taken place, the Government of the Party whose flag the ship was formerly entitled to fly shall, as soon as possible, transmit to the Administration copies of the Certificate carried by the ship before the transfer and, if available, copies of the relevant survey reports.

Part 4 – Design, construction, arrangement and equipment

S Regulation 11 – Design, construction, equipment and operations

- 1 The design, construction, equipment and operation of ships certified to carry noxious liquid substances in bulk identified in chapter 17 of the International Bulk Chemical Code, shall be in compliance with the following provisions to minimize the uncontrolled discharge into the sea of such substances:
 - 1.1 the International Bulk Chemical Code when the chemical tanker is constructed on or after 1 July 1986; or
 - 1.2 the Bulk Chemical Code as referred to in paragraph 1.7.2 of that Code for:
 - 1.2.1 ships for which the building contract is placed on or after 2 November 1973 but constructed before 1 July 1986, and which are engaged on voyages to ports or terminals under the jurisdiction of other States Parties to the Convention; and

- 1.2.2 ships constructed on or after 1 July 1983 but before 1 July 1986, which are engaged solely on voyages between ports or terminals within the State the flag of which the ship is entitled to fly.
- 1.3 The Bulk Chemical Code as referred to in paragraph 1.7.3 of that Code for:
- 1.3.1 ships for which the building contract is placed before 2 November 1973 and which are engaged on voyages to ports or terminals under the jurisdiction of other States Parties to the Convention; and
- 1.3.2 ships constructed before 1 July 1983 which are solely engaged on voyages between ports or terminals within the State the flag of which the ship is entitled to fly.
- 2 In respect of ships other than chemical tankers or liquefied gas carriers certified to carry noxious liquid substances in bulk identified in chapter 17 of the International Bulk Chemical Code, the Administration shall establish appropriate measures based on the Guidelines⁵⁾ developed by the Organization in order to ensure that the provisions shall be such as to minimize the uncontrolled discharge into the sea of such substances.

S Regulation 12 – Pumping, piping, unloading arrangements and slop tanks

- 1 Every ship constructed before 1 July 1986 shall be provided with a pumping and piping arrangement to ensure that each tank certified for the carriage of substances in category X or Y does not retain a quantity of residue in excess of 300 litres in the tank and its associated piping and that each tank certified for the carriage of substances in category Z does not retain a quantity of residue in excess of 900 litres in the tank and its associated piping. A performance test shall be carried out in accordance with appendix 5 of this Chapter.⁶⁾
- 2 Every ship constructed on or after 1 July 1986 but before 1 January 2007 shall be provided with a pumping and piping arrangement to ensure that each tank certified for the carriage of substances in category X or Y does not retain a quantity of residue in excess of 100 litres in the tank and its associated piping and that each tank certified for the carriage of substances in category Z does not retain a quantity of residue in excess of 300 litres in the tank and its associated piping. A performance test shall be carried out in accordance with appendix 5 of this Chapter.⁷⁾
- 3 Every ship constructed on or after 1 January 2007 shall be provided with a pumping and piping arrangement to ensure that each tank certified for the carriage of substances in category X, Y or Z does not retain a quantity of residue in excess of 75 litres in the tank and its associated piping. A performance test shall be carried out in accordance with appendix 5 of this Chapter.⁸⁾
- 4 For a ship other than a chemical tanker constructed before 1 January 2007 which cannot meet the requirements for the pumping and piping arrangements for substances in category Z referred to in paragraphs 1 and 2 of this regulation no quantity requirement shall apply. Compliance is deemed to be reached if the tank is emptied to the most practicable extent.
- 5 Pumping performance tests referred to in paragraphs 1, 2 and 3 of this regulation shall be approved by the Administration. Pumping performance tests shall use water as the test medium.
- 6 Ships certified to carry substances of category X, Y or Z shall have an underwater discharge outlet (or outlets).

⁵⁾ Reference is made to resolutions A.673(16), as may be further amended, and MEPC.148(54).

⁶⁾ Please refer to Appendix 5 of MARPOL Annex II.

⁷⁾ Please refer to Appendix 5 of MARPOL Annex II.

⁸⁾ Please refer to Appendix 5 of MARPOL Annex II.

- 7 For ships constructed before 1 January 2007 and certified to carry substances in category Z an underwater discharge outlet as required under paragraph 6 of this regulation is not mandatory.
- 8 The underwater discharge outlet (or outlets) shall be located within the cargo area in the vicinity of the turn of the bilge and shall be so arranged as to avoid the re-intake of residue/water mixtures by the ship's seawater intakes.
- 9 The underwater discharge outlet arrangement shall be such that the residue/water mixture discharged into the sea will not pass through the ship's boundary layer. To this end, when the discharge is made normal to the ship's shell plating, the minimum diameter of the discharge outlet is governed by the following equation:

where

$$d = Q_d/5L_d$$

d = minimum diameter of the discharge outlet (m)

L_d = distance from the forward perpendicular to the discharge outlet (m)

Q_d = the maximum rate selected at which the ship may discharge a residue/water mixture through the outlet (m³/h).

- 10 When the discharge is directed at an angle to the ship's shell plating, the above relationship shall be modified by substituting for Q_d the component of Q_d which is normal to the ship's shell plating.
- 11 Slop tanks
Although this Chapter does not require the fitting of dedicated slop tanks, slop tanks may be needed for certain washing procedures. Cargo tanks may be used as slop tanks.

Part 5 – Operational discharges of residues of noxious liquid substances

M Regulation 13 – Operational discharges of noxious liquid substances

Attention is drawn to the fact that the following regulation is the Danish Maritime Authority's translation of MARPOL. As regards Danish legislation, reference is made to Consolidated Act no. 925 of 28 September 2005 on protection of the marine environment, chapter 3, and Order no. 166 of 1 April 1987 on classification and categorisation as well as discharge of liquid substances carried in bulk.

Subject to the provisions of regulation 3, the control of discharges of residues of noxious liquid substances or ballast water, tank washings or other mixtures containing such substances shall be in compliance with the following requirements.

1 Discharge provisions

- 1.1 The discharge into the sea of residues of substances assigned to category X, Y or Z or of those provisionally assessed as such or ballast water, tank washings or other mixtures containing such substances shall be prohibited unless such discharges are made in full compliance with the applicable operational requirements contained in this Chapter.

- 1.2 Before any prewash or discharge procedure is carried out in accordance with this regulation, the relevant tank shall be emptied to the maximum extent in accordance with the procedures prescribed in the Manual.
- 1.3 The carriage of substances which have not been categorized, provisionally assessed or evaluated as referred to in regulation 6 of this Chapter or of ballast water, tank washings or other mixtures containing such residues shall be prohibited along with any consequential discharge of such substances into the sea.

2 Discharge standards

- 2.1 Where the provisions in this regulation allow the discharge into the sea of residues of substances in category X, Y or Z or of those provisionally assessed as such or ballast water, tank washings or other mixtures containing such substances, the following discharge standards shall apply:
 - 2.1.1 the ship is proceeding en route at a speed of at least 7 knots in the case of self-propelled ships or at least 4 knots in the case of ships which are not self-propelled;
 - 2.1.2 the discharge is made below the waterline through the underwater discharge outlet(s) not exceeding the maximum rate for which the underwater discharge outlet(s) is (are) designed; and
 - 2.1.3 the discharge is made at a distance of not less than 12 nautical miles from the nearest land in a depth of water of not less than 25 metres.
- 2.2 For ships constructed before 1 January 2007 the discharge into the sea of residues of substances in category Z or of those provisionally assessed as such or ballast water, tank washings or other mixtures containing such substances below the waterline is not mandatory.
- 2.3 The Administration may waive the requirements of paragraph 2.1.3 for substances in category Z, regarding the distance of not less than 12 nautical miles from the nearest land for ships solely engaged in voyages within waters subject to the sovereignty or jurisdiction of the State the flag of which the ship is entitled to fly. In addition, the Administration may waive the same requirement regarding the discharge distance of not less than 12 nautical miles from the nearest land for a particular ship entitled to fly the flag of their State, when engaged in voyages within waters subject to the sovereignty or jurisdiction of one adjacent State after the establishment of an agreement, in writing, of a waiver between the two coastal States involved provided that no third party will be affected. Information on such agreement shall be communicated to the Organization within 30 days for further circulation to the Parties to the Convention for their information and appropriate action if any.

3 Ventilation of cargo residues

Ventilation procedures approved by the Administration may be used to remove cargo residues from a tank. Such procedures shall be in accordance with appendix 7 of this Chapter.⁹⁾ Any water subsequently introduced into the tank shall be regarded as clean and shall not be subject to the discharge requirements in this Chapter.

4 Exemption for a prewash

On request of the ship's master, an exemption for a prewash may be granted by the Government of the receiving Party, where it is satisfied that:

⁹⁾ Please refer to Appendix 7 of MARPOL Annex II.

- 4.1 the unloaded tank is to be reloaded with the same substance or another substance compatible with the previous one and that the tank will not be washed or ballasted prior to loading; or
 - 4.2 the unloaded tank is neither washed nor ballasted at sea. The prewash in accordance with the applicable paragraph of this regulation shall be carried out at another port provided that it has been confirmed in writing that a reception facility at that port is available and is adequate for such a purpose; or
 - 4.3 the cargo residues will be removed by a ventilation procedure approved by the Administration in accordance with appendix 7 of this Chapter.¹⁰⁾
- 5 The use of cleaning agents or additives
- 5.1 When a washing medium other than water, such as mineral oil or chlorinated solvent, is used instead of water to wash a tank, its discharge shall be governed by the provisions of either chapter XXI or chapter XXII which would apply to the medium had it been carried as cargo. Tank washing procedures involving the use of such a medium shall be set out in the Manual and be approved by the Administration.
 - 5.2 When small amounts of cleaning additives (detergent products) are added to water in order to facilitate tank washing, no additives containing pollution category X components shall be used except those components that are readily biodegradable and present in a total concentration of less than 10% of the cleaning additive. No restrictions additional to those applicable to the tank due to the previous cargo shall apply.
- 6 Discharge of residues of category X
- Subject to the provision of paragraph 1, the following provisions shall apply:
- 6.1 A tank from which a substance in category X has been unloaded shall be prewashed before the ship leaves the port of unloading. The resulting residues shall be discharged to a reception facility until the concentration of the substance in the effluent to such facility, as indicated by analyses of samples of the effluent taken by the surveyor, is at or below 0.1% by weight. When the required concentration level has been achieved, remaining tank washings shall continue to be discharged to the reception facility until the tank is empty. Appropriate entries of these operations shall be made in the Cargo Record Book and endorsed by the surveyor referred to in regulation 16.1.
 - 6.2 Any water subsequently introduced into the tank may be discharged into the sea in accordance with the discharge standards in regulation 13.2.
 - 6.3 Where the Government of the receiving party is satisfied that it is impracticable to measure the concentration of the substance in the effluent without causing undue delay to the ship, that Party may accept an alternative procedure as being equivalent to obtain the required concentration in regulation 13.6.1.1 provided that:
 - 6.3.1 the tank is prewashed in accordance with a procedure approved by the Administration in compliance with appendix 6 of this Chapter¹¹⁾; and
 - 6.3.2 appropriate entries shall be made in the Cargo Record Book and endorsed by the surveyor referred to in regulation 16.1.
- 7 Discharge of residues of category Y and Z
- 7.1 Subject to the provision of paragraph 1, the following provisions shall apply:

¹⁰⁾ Please refer to Appendix 7 of MARPOL Annex II.

¹¹⁾ Please refer to Appendix 6 of MARPOL Annex II.

7.1.1 With respect to the residue discharge procedures for substances in category Y or Z, the discharge standards in regulation 13.2 shall apply.

7.1.2 If the unloading of a substance of category Y or Z is not carried out in accordance with the Manual, a prewash shall be carried out before the ship leaves the port of unloading, unless alternative measures are taken to the satisfaction of the surveyor referred to in regulation 16.1 to remove the cargo residues from the ship to quantities specified in this Chapter. The resulting tank washings of the prewash shall be discharged to a reception facility at the port of unloading or another port with a suitable reception facility provided that it has been confirmed in writing that a reception facility at that port is available and is adequate for such a purpose.

7.1.3 For high-viscosity or solidifying substances in category Y, the following shall apply:

7.1.3.1 a prewash procedure as specified in appendix 6 shall be applied¹²⁾;

7.1.3.2 the residue/water mixture generated during the prewash shall be discharged to a reception facility until the tank is empty; and

7.1.3.3 any water subsequently introduced into the tank may be discharged into the sea in accordance with the discharge standards in regulation 13.2.

7.2 Operational requirements for ballasting and deballasting

7.2.1 After unloading, and, if required, after a prewash, a cargo tank may be ballasted. Procedures for the discharge of such ballast are set out in regulation 13.2.

7.2.2 Ballast introduced into a cargo tank which has been washed to such an extent that the ballast contains less than 1 ppm of the substance previously carried may be discharged into the sea without regard to the discharge rate, ship's speed and discharge outlet location, provided that the ship is not less than 12 nautical miles from the nearest land and in water that is not less than 25 metres deep. The required degree of cleanliness has been achieved when a prewash as specified in appendix 6¹³⁾ of this chapter, has been carried out and the tank has been subsequently washed with a complete cycle of the cleaning machine for ships built before 1 July 1994 or with a water quantity not less than that calculated with $k = 1.0$.

7.2.3 The discharge into the sea of clean or segregated ballast shall not be subject to the requirements of this Chapter.

8 Discharges in the Antarctic Area

8.1 Antarctic Area means the sea area south of latitude 60° S.

8.2 In the Antarctic Area any discharge into the sea of noxious liquid substances or mixtures containing such substances is prohibited.

S Regulation 14 – Procedures and Arrangements Manual

1 Every ship certified to carry substances of category X, Y or Z shall have on board a Manual approved by the Administration. The Manual shall have a standard format in compliance with appendix 4 to this Chapter¹⁴⁾. In the case of a ship engaged in international voyages on which the language used is not English, French or Spanish, the text shall include a translation into one of these languages.

¹²⁾ Please refer to Appendix 6 of MARPOL Annex II.

¹³⁾ Please refer to Appendix 6 of MARPOL Annex II.

¹⁴⁾ Please refer to Appendix 4 of MARPOL Annex II.

- 2 The main purpose of the Manual is to identify for the ship's officers the physical arrangements and all the operational procedures with respect to cargo handling, tank cleaning, slops handling and cargo tank ballasting and deballasting which must be followed in order to comply with the requirements of this Chapter.

Regulation 15 – Cargo Record Book

- 1 Every ship to which this Chapter applies shall be provided with a Cargo Record Book, whether as part of the ship's official log-book or otherwise, in the form specified in appendix 2 to this Chapter.¹⁵⁾ *The cargo record book shall be kept in accordance with the instructions provided in the record book.*
- 2 After completion of any operation specified in appendix 2 to this Chapter¹⁶⁾, the operation shall be promptly recorded in the Cargo Record Book.
- 3 In the event of an accidental discharge of a noxious liquid substance or a mixture containing such a substance or a discharge under the provisions of regulation 3, an entry shall be made in the Cargo Record Book stating the circumstances of, and the reason for, the discharge.
- 4 Each entry shall be signed by the officer or officers in charge of the operation concerned and each page shall be signed by the master of the ship. The entries in the Cargo Record Book, for ships holding an International Pollution Prevention Certificate for the Carriage of Noxious Liquid Substances in Bulk or a certificate referred to in regulation 7, shall be at least in English, French or Spanish. Where entries in an official national language of the State whose flag the ship is entitled to fly are also used, this shall prevail in case of a dispute or discrepancy.
- 5 The Cargo Record Book shall be kept in such a place as to be readily available for inspection and, except in the case of unmanned ships under tow, shall be kept on board the ship. It shall be retained for a period of three years after the last entry has been made.
- 6 The competent authority of the Government of a Party may inspect the Cargo Record Book on board any ship to which this Chapter applies while the ship is in its port, and may make a copy of any entry in that book and may require the master of the ship to certify that the copy is a true copy of such entry. Any copy so made which has been certified by the master of the ship as a true copy of an entry in the ship's Cargo Record Book shall be made admissible in any judicial proceedings as evidence of the facts stated in the entry. The inspection of a Cargo Record Book and the taking of a certified copy by the competent authority under this paragraph shall be performed as expeditiously as possible without causing the ship to be unduly delayed.
- 7 *The cargo record book shall be kept in an easily legible hand, and no page may be torn out. What has been recorded once may not be erased, crossed out or in any other way be made illegible. If it becomes necessary to correct anything in the record, the correction shall be added as a remark.*

Part 6 – Measures of control by port States

S Regulation 16 – Measures of control

- 1 The Government of each Party to the Convention shall appoint or authorize surveyors for the purpose of implementing this regulation. The surveyors shall execute control in accordance with control procedures developed by the Organization.¹⁷⁾

¹⁵⁾ Please refer to Appendix 2 of MARPOL Annex II.

¹⁶⁾ Please refer to Appendix 2 of MARPOL Annex II.

- 2 When a surveyor appointed or authorized by the Government of the Party to the Convention has verified that an operation has been carried out in accordance with the requirements of the Manual, or has granted an exemption for a prewash, then that surveyor shall make an appropriate entry in the Cargo Record Book.
- 3 The master of a ship certified to carry noxious liquid substances in bulk shall ensure that the provisions of regulation 13 and of this regulation have been complied with and that the Cargo Record Book is completed in accordance with regulation 15 whenever operations as referred to in that regulation take place.
- 4 A tank which has carried a category X substance shall be prewashed in accordance with regulation 13.6. The appropriate entries of these operations shall be made in the Cargo Record Book and endorsed by the surveyor referred to under paragraph 1 of this regulation.
- 5 Where the Government of the receiving party is satisfied that it is impracticable to measure the concentration of the substance in the effluent without causing undue delay to the ship, that Party may accept the alternative procedure referred to in regulation 13.6.3 provided that the surveyor referred to under paragraph 1 of this regulation certifies in the Cargo Record Book that:
 - 5.1 the tank, its pump and piping systems have been emptied; and
 - 5.2 the prewash has been carried out in accordance with the provisions of appendix 6 of this Chapter¹⁸⁾; and
 - 5.3 the tank washings resulting from such prewash have been discharged to a reception facility and the tank is empty.
- 6 At the request of the ship's master, the Government of the receiving Party may exempt the ship from the requirements for a prewash referred to in the applicable paragraphs of regulation 13 when one of the conditions of regulation 13.4 is met.
- 7 An exemption referred to in paragraph 6 of this regulation may only be granted by the Government of the receiving Party to a ship engaged in voyages to ports or terminals under the jurisdiction of other States Parties to the present Convention. When such an exemption has been granted, the appropriate entry made in the Cargo Record Book shall be endorsed by the surveyor referred to in paragraph 1 of this regulation.
- 8 If the unloading is not carried out in accordance with the pumping conditions for the tank approved by the Administrations and based on appendix 5 of this Chapter¹⁹⁾, alternative measures may be taken to the satisfaction of the surveyor referred to in paragraph 1 of this regulation to remove the cargo residues from the ship to quantities specified in regulation 12 as applicable. The appropriate entries shall be made in the Cargo Record Book.
- 9 Port State control on operational requirements²⁰⁾
 - 9.1 A ship when in a port of another Party is subject to inspection by officers duly authorized by such Party concerning operational requirements under this Chapter, where there are clear grounds for believing that the master or crew are not familiar with essential shipboard procedures relating to the prevention of pollution by noxious liquid substances.

¹⁷⁾ Refer to the Procedures for port State control adopted by the Organization by resolution A.787(19) as amended by resolution A.882(21) and as may be further amended.

¹⁸⁾ Please refer to Appendix 6 of MARPOL Annex II.

¹⁹⁾ Please refer to Appendix 5 of MARPOL Annex II.

²⁰⁾ Refer to the Procedures for port State control adopted by the Organization by resolution A.787(19) as amended by resolution A.882(21) and as may be further amended.

- 9.2 In the circumstances given in paragraph 9.1 of this regulation, the Party shall take such steps as will ensure that the ship shall not sail until the situation has been brought to order in accordance with the requirements of this Chapter.
 - 9.4 Procedures relating to the port State control prescribed in article 5 of the present Convention shall apply to this regulation.
 - 9.5 Nothing in this regulation shall be construed to limit the rights and obligations of a Party carrying out control over operational requirements specifically provided for in the present Convention.
- 10 *The ship's agent shall inform the Danish Maritime Authority or the surveyor mentioned in paragraph 2 about the calls of ships that are to unload harmful, liquid substances carried in bulk. The information shall be given so early that it is possible to make the recording under paragraph 2 without the ship being unduly delayed.*

Part 7 – Prevention of pollution arising from an incident involving noxious liquid substances

S Regulation 17 – Shipboard marine pollution emergency plan for noxious liquid substances

- 1 Every ship of 150 gross tonnage and above certified to carry noxious liquid substances in bulk shall carry on board a shipboard marine pollution emergency plan for noxious liquid substances approved by the Administration.
- 2 Such a plan shall be based on the Guidelines²¹⁾ developed by the Organization and written in a working language or languages understood by the master and officers. The plan shall consist at least of:
 - 2.1 the procedure to be followed by the master or other persons having charge of the ship to report a noxious liquid substances pollution incident, as required in article 8 and Protocol I of the present Convention, based on the Guidelines developed by the Organization;²²⁾
 - 2.2 the list of authorities or persons to be contacted in the event of a noxious liquid substances pollution incident;
 - 2.3 a detailed description of the action to be taken immediately by persons on board to reduce or control the discharge of noxious liquid substances following the incident; and
 - 2.4 the procedures and point of contact on the ship for coordinating shipboard action with national and local authorities in combating the pollution.
- 3 In the case of ships to which regulation 37 of Chapter XXI of the Convention also applies, such a plan may be combined with the shipboard oil pollution emergency plan required under regulation 37 of Chapter XXI of the Convention. In this case, the title of such a plan shall be “Shipboard marine pollution emergency plan”.

²¹⁾ Refer to “Guidelines for the development of shipboard marine pollution emergency plans for oil and/or noxious liquid substances” adopted by the Marine Environment Protection Committee of the Organization by resolution MEPC.85(44), as amended by resolution MEPC.137(53).

²²⁾ Refer to General principles for ship reporting systems and ship reporting requirements, including guidelines for reporting incidents involving dangerous goods, harmful substances and/or marine pollutants, adopted by the Organization by resolution A.851(20), as amended by resolution MEPC.138(53).

M Regulation 18 – Reception facilities and cargo unloading terminal arrangements

Attention is drawn to the fact that the following regulation is the Danish Maritime Authority's translation of MARPOL. As regards Danish legislation, reference is made to Consolidated Act no. 925 of 28 September 2005 on protection of the marine environment, chapter 3, and Order no. 166 of 1 April 1987 on classification and categorisation as well as discharge of liquid substances carried in bulk.

- 1 The Government of each Party to the Convention undertakes to ensure the provision of reception facilities according to the needs of ships using its ports, terminals or repair ports as follows:
 - 1.1 ports and terminals involved in ships' cargo handling shall have adequate facilities for the reception of residues and mixtures containing such residues of noxious liquid substances resulting from compliance with this Chapter, without undue delay for the ships involved.
 - 1.2 ship repair ports undertaking repairs to NLS tankers shall provide facilities adequate for the reception of residues and mixtures containing noxious liquid substances for ships calling at that port.
- 3 The Government of each Party shall determine the types of facilities provided for the purpose of paragraph 1 of this regulation at each cargo loading and unloading port, terminal and ship repair port in its territories and notify the Organization thereof.
- 4 The Governments of Parties to the Convention, the coastlines of which border on any given special area, shall collectively agree and establish a date by which time the requirement of paragraph 1 of this regulation will be fulfilled and from which the requirements of the applicable paragraphs of regulation 13 in respect of that area shall take effect and notify the Organization of the date so established at least six months in advance of that date. The Organization shall then promptly notify all Parties of that date.
- 5 The Government of each Party to the Convention shall undertake to ensure that cargo unloading terminals shall provide arrangements to facilitate stripping of cargo tanks of ships unloading noxious liquid substances at these terminals. Cargo hoses and piping systems of the terminal, containing noxious liquid substances received from ships unloading these substances at the terminal, shall not be drained back to the ship.
- 6 Each Party shall notify the Organization, for transmission to the Parties concerned, of any case where facilities required under paragraph 1 or arrangements required under paragraph 3 of this regulation are alleged to be inadequate.

Appendices to Chapter XXII

Appendix 1

Guidelines for the categorization of noxious liquid substances

Appendix 2

Form of Cargo Record Book for ships carrying noxious liquid substances in bulk

Appendix 3

Form of international Pollution Prevention Certificate for the Carriage of Noxious Liquid Substances in Bulk

Appendix 4

Standard format for the Procedures and Arrangements Manual

Appendix 5

Assessment of residue quantities in cargo tanks, pumps and associated piping

Appendix 6

Prewash Procedures

Appendix 7

Ventilation procedures

**Notice from the Danish Maritime Authority B – The Construction and Equipment,
etc. of Ships**

Chapter B XXIII

**Regulations for the Prevention of Pollution by Harmful Substances
Carried by Sea in Packaged Form**

Introduction.....	1
Regulation 1 – Application	2
Regulation 2 – Packing	2
Regulation 3 – Marking and labelling.....	2
Regulation 4- Documentation	3
Regulation 5 – Stowage	3
Regulation 6 – Quantity limitations	3
M Regulation 7 – Exceptions.....	3
Regulation 8 – Port State control on operational requirements	4

Introduction

The provisions of chapter XXIII have been drawn up on the basis of annex III to the International Convention for the Prevention of Pollution from Ships – the 1973 MARPOL Convention – with the amendments and additions contained in the 1978 Protocol to MARPOL 1973, as amended.

The provisions cover all ships carrying harmful substances in packaged form. The shall not apply to the ship’s equipment and stores.

Provisions marked with an “M” in the table of contents are administered by the Danish Environmental Protection Agency, while provisions marked with an “S” in the table of contents are administered by the Danish Maritime Authority.

The provisions are primarily of an operational nature and aimed at shippers of harmful substances (packing, marking and documentation).

In connection with the implementation of the provisions of the MARPOL Convention in Denmark, orders have been issued by the Danish Ministry of the Environment, which must be observed as well, in addition to the technical regulations contained in the sets of regulations issued by the Danish Maritime Authority.

In these provisions, the IMO is referred to as the Organisation, MARPOL 73/78 is referred to as the Convention, and the Danish Environmental Protection Agency and the Danish Maritime Authority, respectively, are referred to as the Administration.

Regulation 1 – Application

1. Unless expressly provided otherwise, the regulations of this Chapter apply to all ships carrying harmful substances in packaged form.
 - 1.1. For the purpose of this Chapter, "harmful substances" are those substances which are identified as marine pollutants in the International Maritime Dangerous Goods Code (IMDG Code)¹ or which meet the criteria in the Appendix of this Chapter.
 - 1.2. For the purposes of this Chapter, "packaged form" is defined as the forms of containment specified for harmful substances in the IMDG Code.
2. The carriage of harmful substances is prohibited, except in accordance with the provisions of this Chapter.
3. To supplement the provisions of this Chapter, the Government of each Party to the Convention shall issue, or cause to be issued, detailed requirements on packing, marking, labelling, documentation, stowage, quantity limitations and exceptions for preventing or minimizing pollution of the marine environment by harmful substances.²
4. For the purposes of this Chapter, empty packagings which have been used previously for the carriage of harmful substances shall themselves be treated as harmful substances unless adequate precautions have been taken to ensure that they contain no residue that is harmful to the marine environment.
5. The requirements of this Chapter do not apply to ship's stores and equipment.

Regulation 2 – Packing

Packages shall be adequate to minimize the hazard to the marine environment, having regard to their specific contents.

Regulation 3 – Marking and labelling

1. Packages containing a harmful substance shall be durably marked with the correct technical name (trade names alone shall not be used) and, further, shall be durably marked or labelled to indicate that the substance is a marine pollutant. Such identification shall be supplemented where possible by any other means, for example, by use of the relevant United Nations number.
2. The method of marking the correct technical name and of affixing labels on packages containing a harmful substance shall be such that this information will still be identifiable on packages surviving at least three months' immersion in the sea. In considering suitable marking and labelling, account shall be taken of the durability of the materials used and of the surface of the package.
3. Packages containing small quantities of harmful substances may be exempted from the marking requirements.³

¹ Refer to the IMDG Code adopted by the Organization by resolution MSC.122(75), as amended by the Maritime Safety Committee.

² Refer to the IMDG Code adopted by the Organization by resolution MSC.122(75), as amended by the Maritime Safety Committee.

³ Refer to the specific exemptions provided for in the IMDG Code adopted by resolution MSC.122(75), as amended.

Regulation 4- Documentation⁴

1. In all documents relating to the carriage of harmful substances by sea where such substances are named, the correct technical name of each such substance shall be used (trade names alone shall not be used) and the substance further identified by the addition of the words "MARINE POLLUTANT".
2. The shipping documents supplied by the shipper shall include, or be accompanied by, a signed certificate or declaration that the shipment offered for carriage is properly packaged and marked, labelled or placarded as appropriate and in proper condition for carriage to minimize the hazard to the marine environment.
3. Each ship carrying harmful substances shall have a special list or manifest setting forth the harmful substances on board and the location thereof. A detailed stowage plan which sets out the location of the harmful substances on board may be used in place of such special list or manifest. Copies of such documents shall also be retained on shore by the owner of the ship or his representative until the harmful substances are unloaded. A copy of one of these documents shall be made available before departure to the person or organization designated by the port State authority.
4. At any stopover, where any loading or unloading operations, even partial, are carried out, a revision of the documents listing the harmful substances taken on board, indicating their location on board or showing a detailed stowage plan, shall be made available before departure to the person or organization designated by the port State authority.
5. When the ship carries a special list or manifest or a detailed stowage plan, required for the carriage of dangerous goods by the International Convention for the Safety of Life at Sea, 1974, as amended, the documents required by this regulation may be combined with those for dangerous goods. Where documents are combined, a clear distinction shall be made between dangerous goods and harmful substances covered by this Chapter.

Regulation 5 – Stowage

Harmful substances shall be properly stowed and secured so as to minimize the hazards to the marine environment without impairing the safety of the ship and persons on board.

Regulation 6 – Quantity limitations

Certain harmful substances may, for sound scientific and technical reasons, need to be prohibited for carriage or be limited as to the quantity which may be carried aboard any one ship. In limiting the quantity, due consideration shall be given to size, construction and equipment of the ship, as well as the packaging and the inherent nature of the substances.

M Regulation 7 – Exceptions

Attention is drawn to the fact that this regulation is the Danish Maritime Authority's translation of MARPOL. As regards Danish legislation, reference is made to the Danish Ministry of the Environment.

1. Jettisoning of harmful substances carried in packaged form shall be prohibited, except where necessary for the purpose of securing the safety of the ship or saving life at sea.

⁴ Reference to "documents" in this regulation does not preclude the use of electronic data processing (EDP) and electronic data interchange (EDI) transmission techniques as an aid to paper documentation.

2. Subject to the provisions of the Convention, appropriate measures based on the physical, chemical and biological properties of harmful substances shall be taken to regulate the washing of leakages overboard, provided that compliance with such measures would not impair the safety of the ship and persons on board.

Regulation 8 – Port State control on operational requirements⁵

1. A ship when in a port or an offshore terminal of another Party is subject to inspection by officers duly authorized by such Party concerning operational requirements under this Chapter, where there are clear grounds for believing that the master or crew are not familiar with essential shipboard procedures relating to the prevention of pollution by harmful substances.
2. In the circumstances given in paragraph (1) of this regulation, the Party shall take such steps as will ensure that the ship shall not sail until the situation has been brought to order in accordance with the requirements of this Chapter.
3. Procedures relating to the port State control prescribed in article 5 of the MARPOL Convention shall apply to this regulation.
4. Nothing in this regulation shall be construed to limit the rights and obligations of a Party carrying out control over operational requirements specifically provided for in the MARPOL Convention.

⁵ Refer to the Procedures for port State control adopted by the Organization by resolution A.742(18), as amended by A.882(21).

Appendix

Criteria for the identification of harmful substances in packaged form

For the purposes of this Chapter, substances identified by any one of the following criteria are harmful substances:⁶

Category: Acute 1

96 hr LC ₅₀ (for fish)	≤ 1 mg/l and/or
48 hr EC ₅₀ (for crustacean)	≤ 1 mg/l and/or
<u>72 or 96 hr ErC₅₀ (for algae or other aquatic plants)</u>	<u>< 1 mg/l</u>

Category: Chronic 1

96 hr LC ₅₀ (for fish)	≤ 1 mg/l and/or
48 hr EC ₅₀ (for crustacean)	≤ 1 mg/l and/or
<u>72 or 96 hr ErC₅₀ (for algae or other aquatic plants)</u>	<u>< 1 mg/l</u>

and the substance is not rapidly degradable and/or the log K_{ow} > 4 (unless the experimentally determined BCF < 500).

Category: Chronic 2

96 hr LC ₅₀ (for fish)	≤ 1 to ≤ 10 mg/l and/or
48 hr EC ₅₀ (for crustacean)	> 1 to ≤ 10 mg/l and/or
<u>72 or 96 hr ErC₅₀ (for algae or other aquatic plants)</u>	<u>> 1 to < 10 mg/l</u>

and the substance is not rapidly degradable and/or the log K_{ow} > 4 (unless the experimentally determined BCF < 500), unless the chronic toxicity NOECs are > 1 mg/l.

⁶ The criteria are based on those developed by the United Nations Globally Harmonized System of Classification and Labelling of Chemicals (GHS), as amended.

For definitions of acronyms or terms used in this appendix, refer to the relevant paragraphs of the IMDG Code.

**Notice from the Danish Maritime Authority B – The Construction and Equipment,
etc. of Ships**

Chapter B XXIV

**Regulations for the Prevention of Pollution by Sewage from Ships
of 1 April 2008**

Regulation 1 – Definitions	2
Regulation 2 – Application	3
Regulation 3 – Exceptions	3
S Regulation 4 – Surveys	4
S Regulation 5 – Issue or endorsement of Certificate.....	5
S Regulation 6 – Issue or endorsement of a Certificate by another Government	5
S Regulation 7 – Form of Certificate	6
S Regulation 8 – Duration and validity of Certificate	6
S Regulation 9 – Sewage systems	7
S Regulation 10 – Standard discharge connections	8
M Regulation 11 – Discharge of sewage	8
M Regulation 12 – Reception facilities.....	9
S Regulation 13 – Port State control on operational requirements	9
<i>S Regulation 1 – Application</i>	<i>10</i>
<i>S Regulation 2 – Definition</i>	<i>10</i>
<i>S Regulation 3 – Requirements for new vessels</i>	<i>10</i>
<i>S Regulation 4 – Requirements for existing vessels</i>	<i>10</i>
<i>M Regulation 5 – The use of products for disinfecting and other purposes</i>	<i>10</i>

Introduction

The provisions of chapter XXIV (previously chapter XX) have been drawn up on the basis of annex IV to the International Convention for the Prevention of Pollution from Ships – the 1973 MARPOL Convention – as amended, as well as Annex IV, regulations 4 and 5 of the Helsinki Convention.

The administration of the rules has been distributed so that the Danish Environmental Protection Agency is responsible for the rules on discharge, and the Danish Maritime Authority is responsible for the rules on the technical installations on board the ships, including records and plans. This distribution of responsibility has been indicated in the table of contents with an “M” for the Danish Environmental Protection Agency and an “S” for the Danish Maritime Authority.

In addition to the technical regulations contained in the sets of regulations issued by the Danish Maritime Authority, orders have been issued by the Danish Ministry of the Environment, which must be observed as well.

In these provisions, the IMO is referred to as the Organisation, MARPOL 73/78 is referred to as the Convention, and the Danish Environmental Protection Agency and the Danish Maritime Authority, respectively, are referred to as the Administration.

Part 1 – Treatment and storage of sewage in large ships

1. General

Regulation 1 – Definitions

For the purposes of this Chapter:

1. “New ship” means a ship:
 - 1.1. for which the building contract is placed, or in the absence of a building contract, the keel of which is laid, or which is at a similar stage of construction, on or after 27 September 2003; or
 - 1.2. the delivery of which is on or after 27 September 2006.
2. “Existing ship” means a ship which is not a new ship.
3. “Sewage” means:
 - 3.1. drainage and other wastes from any form of toilets and urinals;
 - 3.2. drainage from medical premises (dispensary, sick bay, etc.) via wash basins, wash tubs and scuppers located in such premises;
 - 3.3. drainage from spaces containing living animals; or
 - 3.4. other waste waters when mixed with the drainages defined above.
4. “Holding tank” means a tank used for the collection and storage of sewage.
5. “Nearest land”. The term "from the nearest land" means from the baseline from which the territorial sea of the territory in question is established in accordance with international law except that, for the purposes of the present Convention, "from the nearest land" off the north-eastern coast of Australia shall mean from a line drawn from a point on the coast of Australia in:

latitude 11°00' S, longitude 142°08' E
to a point in latitude 10°35' S, longitude 141°55' E,
thence to a point latitude 10°00' S, longitude 142° 00' E,

thence to a point latitude 09°10' S, longitude 143° 52' E,
thence to a point latitude 09°00' S, longitude 144° 30' E,
thence to a point latitude 10°41' S, longitude 145° 00' E,
thence to a point latitude 13°00' S, longitude 145° 00' E,
thence to a point latitude 15°00' S, longitude 146° 00' E,
thence to a point latitude 17°30' S, longitude 147° 00' E,
thence to a point latitude 21°00' S, longitude 152° 55' E,
thence to a point latitude 24°30' S, longitude 154° 00' E,
thence to a point on the coast of Australia in latitude 24°42' S, longitude 153°15' E.

6. “International voyage” means a voyage from a country to which the present Convention applies to a port outside such country, or conversely.
7. “Person” means member of the crew and passengers.
8. “Anniversary date” means the day and the month of each year which will correspond to the date of expiry of the International Sewage Pollution Prevention Certificate.

Regulation 2 – Application

1. The provisions of this Chapter shall apply to the following ships engaged in domestic and *international*¹⁾ voyages:
 - 1.1. new ships of 400 gross tonnage and above; and
 - 1.2. new ships of less than 400 gross tonnage which are certified to carry more than 15 persons; and
 - 1.2.a. *Existing ships engaged in service in the Baltic Sea area and Danish territorial waters with a gross tonnage of or above 400,*
 - 1.2.b. *Existing ships engaged in service in the Baltic Sea area and Danish territorial waters with a gross tonnage below 400, approved for carrying more than 15 persons,*
 - 1.3. existing ships of 400 gross tonnage and above no later than 27 September 2008; and
 - 1.4. existing ships of less than 400 gross tonnage which are certified to carry more than 15 persons no later than 27 September 2008.
2. The Administration shall ensure that existing ships, according to subparagraphs 1.3 and 1.4 of this regulation, the keels of which are laid or which are of a similar stage of construction before 2 October 1983 shall be equipped, as far as practicable, to discharge sewage in accordance with the requirements of regulation 11 of this Chapter.

Regulation 3 – Exceptions

1. 1 Regulation 11 of this Chapter shall not apply to:
 - 1.1. the discharge of sewage from a ship necessary for the purpose of securing the safety of a ship and those on board or saving life at sea; or
 - 1.2. the discharge of sewage resulting from damage to a ship or its equipment if all reasonable precautions have been taken before and after the occurrence of the damage, for the purpose of preventing or minimizing the discharge.

¹⁾ Shall, however, not apply to ships engaged in domestic voyages in Greenland.

2. Surveys and certificates

S Regulation 4 – Surveys

1. Every ship which, in accordance with regulation 2, is required to comply with the provisions of this Chapter shall be subject to the surveys specified below:
 - 1.1. An initial survey before the ship is put in service or before the Certificate required under regulation 5 of this Chapter is issued for the first time, which shall include a complete survey of its structure, equipment, systems, fittings, arrangements and material in so far as the ship is covered by this Chapter. This survey shall be such as to ensure that the structure, equipment, systems, fittings, arrangements and materials fully comply with the applicable requirements of this Chapter.
 - 1.2. A renewal survey at intervals specified by the Administration, but not exceeding five years, except where regulation 8.2, 8.5, 8.6 or 8.7 of this Chapter is applicable. The renewal survey shall be such as to ensure that the structure, equipment, systems, fittings, arrangements and materials fully comply with applicable requirements of this Chapter.
 - 1.3. An additional survey, either general or partial, according to the circumstances, shall be made after a repair resulting from investigations prescribed in paragraph 4 of this regulation, or whenever any important repairs or renewals are made. The survey shall be such as to ensure that the necessary repairs or renewals have been effectively made, that the material and workmanship of such repairs or renewals are in all respects satisfactory and that the ship complies in all respects with the requirements of this Chapter.
2. The Administration shall establish appropriate measures for ships which are not subject to the provisions of paragraph 1 of this regulation in order to ensure that the applicable provisions of this Chapter are complied with.
3. Surveys of ships as regards the enforcement of the provisions of this Chapter shall be carried out by officers of the Administration. The Administration may, however, entrust the surveys either to surveyors nominated for the purpose or to organizations recognized by it.
4. An Administration nominating surveyors or recognizing organizations to conduct surveys as set forth in paragraph 3 of this regulation shall, as a minimum, empower any nominated surveyor or recognized organization to:
 - 4.1. require repairs to a ship; and
 - 4.2. carry out surveys if requested by the appropriate authorities of a Port State.

The Administration shall notify the Organization of the specific responsibilities and conditions of the authority delegated to the nominated surveyors or recognized organizations, for circulation to Parties to the present Convention for the information of their officers.

5. When a nominated surveyor or recognized organization determines that the condition of the ship or its equipment does not correspond substantially with the particulars of the Certificate or is such that the ship is not fit to proceed to sea without presenting an unreasonable threat of harm to the marine environment, such surveyor or organization shall immediately ensure that corrective action is taken and shall in due course notify the Administration. If such corrective action is not taken, the Certificate should be withdrawn and the Administration shall be notified immediately and if the ship is in a port of another Party, the appropriate authorities of the Port State shall also be notified

immediately. When an officer of the Administration, a nominated surveyor or recognized organization has notified the appropriate authorities of the Port State, the Government of the Port State concerned shall give such officer, surveyor or organization any necessary assistance to carry out their obligations under this regulation. When applicable, the Government of the Port State concerned shall take such steps as will ensure that the ship shall not sail until it can proceed to sea or leave the port for the purpose of proceeding to the nearest appropriate repair yard available without presenting an unreasonable threat of harm to the marine environment.

6. In every case, the Administration concerned shall fully guarantee the completeness and efficiency of the survey and shall undertake to ensure the necessary arrangements to satisfy this obligation.
7. The condition of the ship and its equipment shall be maintained to conform with the provisions of the present Convention to ensure that the ship in all respects will remain fit to proceed to sea without presenting an unreasonable threat of harm to the marine environment.
8. After any survey of the ship under paragraph 1 of this regulation has been completed, no change shall be made in the structure, equipment, systems, fittings, arrangements or materials covered by the survey, without the sanction of the Administration, except the direct replacement of such equipment and fittings.
9. Whenever an accident occurs to a ship or a defect is discovered which substantially affects the integrity of the ship or the efficiency or completeness of its equipment covered by this Chapter, the master or owner of the ship shall report at the earliest opportunity to the Administration, the recognized organization or the nominated surveyor responsible for issuing the relevant Certificate, who shall cause investigations to be initiated to determine whether a survey as required by paragraph 1 of this regulation is necessary. If the ship is in a port of another Party, the master or owner shall also report immediately to the appropriate authorities of the Port State and the nominated surveyor or recognized organization shall ascertain that such report has been made.

S Regulation 5 – Issue or endorsement of Certificate

1. An International Sewage Pollution Prevention Certificate shall be issued, after an initial or renewal survey in accordance with the provisions of regulation 4 of this Chapter, to any ship which is engaged in voyages to ports or offshore terminals under the jurisdiction of other Parties to the Convention. In the case of existing ships this requirement shall apply from 27 September 2008.
2. Such Certificate shall be issued or endorsed either by the Administration or by any persons or organization²⁾ duly authorized by it. In every case, the Administration assumes full responsibility for the Certificate.

S Regulation 6 – Issue or endorsement of a Certificate by another Government

1. The Government of a Party to the Convention may, at the request of the Administration, cause a ship to be surveyed and, if satisfied that the provisions of this Chapter are complied with, shall issue or authorize the issue of an International Sewage Pollution Prevention Certificate to the ship, and where appropriate, endorse or authorize the endorsement of that Certificate on the ship in accordance with this Chapter.

²⁾ Refer to the Guidelines for the authorization of organizations acting on behalf of the Administration, adopted by the Organization by resolution A.739 (18), and the Specifications on the survey and certification functions of recognized organizations acting on behalf of the Administration, adopted by the Organization by resolution A.789(19).

2. A copy of the Certificate and a copy of the survey report shall be transmitted as soon as possible to the Administration requesting the survey.
3. A Certificate so issued shall contain a statement to the effect that it has been issued at the request of the Administration and it shall have the same force and receive the same recognition as the Certificate issued under regulation 5 of this Chapter.
4. No International Sewage Pollution Prevention Certificate shall be issued to a ship which is entitled to fly the flag of a State which is not a Party.

S Regulation 7 – Form of Certificate

The International Sewage Pollution Prevention Certificate shall be drawn up in the form corresponding to the model given in appendix 1 C to this regulation. If the language used is not English, French or Spanish, the text shall contain a translation into one of these languages.

S Regulation 8 – Duration and validity of Certificate

1. An International Sewage Pollution Prevention Certificate shall be issued for a period specified by the Administration which shall not exceed five years.
2.
 - 2.1. Notwithstanding the requirements of paragraph 1 of this regulation, when the renewal survey is completed within three months before the expiry date of the existing Certificate, the new Certificate shall be valid from the date of completion of the renewal survey to a date not exceeding five years from the date of expiry of the existing Certificate.
 - 2.2. When the renewal survey is completed after the expiry date of the existing Certificate, the new Certificate shall be valid from the date of completion of the renewal survey to a date not exceeding five years from the date of expiry of the existing Certificate.
 - 2.3. When the renewal survey is completed more than three months before the expiry date of the existing Certificate, the new Certificate shall be valid from the date of completion of the renewal survey to a date not exceeding five years from the date of completion of the renewal survey.
3. If a Certificate is issued for a period of less than five years, the Administration may extend the validity of the Certificate beyond the expiry date to the maximum period specified in paragraph 1 of this regulation.
4. If a renewal survey has been completed and a new Certificate cannot be issued or placed on board the ship before the expiry date of the existing Certificate, the person or organization authorized by the Administration may endorse the existing Certificate and such a Certificate shall be accepted as valid for a further period which shall not exceed five months from the expiry date.
5. If a ship at the time when a Certificate expires is not in a port in which it is to be surveyed, the Administration may extend the period of validity of the Certificate but this extension shall be granted only for the purpose of allowing the ship to complete its voyage to the port in which it is to be surveyed and then only in cases where it appears proper and reasonable to do so. No Certificate shall be extended for a period longer than three months, and a ship to which an extension is granted shall not, on its arrival in the port in which it is to be surveyed, be entitled by virtue of such extension to leave that port without having a new Certificate. When the renewal survey is completed, the new Certificate shall be valid to a date not exceeding five years from the date of expiry of the existing Certificate before the extension was granted.

6. A Certificate issued to a ship engaged on short voyages which has not been extended under the foregoing provisions of this regulation may be extended by the Administration for a period of grace of up to one month from the date of expiry stated on it. When the renewal survey is completed, the new Certificate shall be valid to a date not exceeding five years from the date of expiry of the existing Certificate before the extension was granted.
7. In special circumstances, as determined by the Administration, a new Certificate need not be dated from the date of expiry of the existing Certificate as required by paragraph 2.2, 5 or 6 of this regulation. In these special circumstances, the new Certificate shall be valid to a date not exceeding five years from the date of completion of the renewal survey.
8. A Certificate issued under regulation 5 or 6 of this Chapter shall cease to be valid in any of the following cases:
 - 8.1. if the relevant surveys are not completed within the periods specified under regulation 4.1 of this Chapter; or
 - 8.2. upon transfer of the ship to the flag of another State. A new Certificate shall only be issued when the Government issuing the new Certificate is fully satisfied that the ship is in compliance with the requirements of regulations 4.7 and 4.8 of this Chapter. In the case of a transfer between Parties, if requested within 3 months after the transfer has taken place, the Government of the Party whose flag the ship was formerly entitled to fly shall, as soon as possible, transmit to the Administration copies of the Certificate carried by the ship before the transfer and, if available, copies of the relevant survey reports.

3. Equipment and control of discharge

S Regulation 9 – Sewage systems

1. Every ship which, in accordance with regulation 2 is required to comply with the provisions of this Chapter shall be equipped with one of the following sewage systems:
 - 1.1. a sewage treatment plant which shall be of a type approved by the Administration, taking into account the standards and test methods developed by the Organization,³⁾ or
 - 1.2. a sewage comminuting and disinfecting system approved by the Administration. Such system shall be fitted with facilities to the satisfaction of the Administration, for the temporary storage of sewage when the ship is less than 3 nautical miles from the nearest land, or
 - 1.3. a holding tank of the capacity to the satisfaction of the Administration for the retention of all sewage, having regard to the operation of the ship, the number of persons on board and other relevant factors.⁴ The holding tank shall be constructed to the satisfaction of the Administration and shall have a means to indicate visually the amount of its contents.

³⁾ Refer to the Recommendation on international effluent standards and guidelines for performance tests for sewage treatment plants adopted by the Marine Environment Protection Committee of the Organization by resolution MEPC.2(VI) on 3 December 1976. For existing ships, national specifications are acceptable. *Guidelines on the type-testing and approval of systems for treating and storing sewage are stipulated as Appendix 1 of technical regulation no. 1 of 15 February 1990 in Notices from the Danish Maritime Authority 2/90 and 5/90.*

⁴ Guidelines and capacity calculations of systems for sewage are given as Appendix B of technical regulation no. 1 of 15 February 1990 in Notices from the Danish Maritime Authority 2/90 and 5/90.

S Regulation 10 – Standard discharge connections

1. To enable pipes of reception facilities to be connected with the ship's discharge pipeline, both lines shall be fitted with a standard discharge connection in accordance with the following table:

Standard dimensions of flanges for discharge connections

Description	Dimension
Outside diameter	210 mm
Inner diameter	According to pipe outside diameter
Bolt circle diameter	170 mm
Slots in flange	4 holes, 18 mm in diameter, equidistantly placed on a bolt circle of the above diameter, slotted to the flange periphery. The slot width to be 18 mm
Flange thickness	16 mm
Bolts and nuts: quantity and diameter	4, each of 16 mm in diameter and of suitable length
The flange is designed to accept pipes up to a maximum internal diameter of 100 mm and shall be of steel or other equivalent material having a flat face. This flange, together with a suitable gasket, shall be suitable for a service pressure of 600 kPa	

For ships having a moulded depth of 5 m and less, the inner diameter of the discharge connection may be 38 mm.

2. For ships in dedicated trades, i.e. passenger ferries, alternatively the ship's discharge pipeline may be fitted with a discharge connection which can be accepted by the Administration, such as quick-connection couplings.

M Regulation 11 – Discharge of sewage

Attention is drawn to the fact that the following regulation is the Danish Maritime Authority's translation of MARPOL. As regards Danish legislation, reference is made to the Ministry of the Environment.

1. Subject to the provisions of regulation 3 of this Chapter, the discharge of sewage into the sea is prohibited, except when:
 - 1.1. the ship is discharging comminuted and disinfected sewage using a system approved by the Administration in accordance with regulation 9.1.2 of this Chapter at a distance of more than 3 nautical miles from the nearest land, or sewage which is not comminuted or disinfected, at a distance of more than 12 nautical miles from the nearest land, provided that, in any case, the sewage that has been stored in holding tanks, or sewage originating from spaces containing living animals, shall not be discharged instantaneously but at a moderate rate when the ship is en route and proceeding at not less than 4 knots; the rate of discharge shall be approved by the Administration based upon standards developed by the Organization; or

- 1.2. the ship has in operation an approved sewage treatment plant which has been certified by the Administration to meet the operational requirements referred to in regulation 9.1.1 of this Chapter, and
 - 1.2.1. the test results of the plant are laid down in the ship's International Sewage Pollution Prevention Certificate; and
 - 1.2.2. additionally, the effluent shall not produce visible floating solids nor cause discoloration of the surrounding water.
2. The provisions of paragraph 1 shall not apply to ships operating in the waters under the jurisdiction of a State and visiting ships from other States while they are in these waters and are discharging sewage in accordance with such less stringent requirements as may be imposed by such State.
3. When the sewage is mixed with wastes or waste water covered by other chapters of this regulation, the requirements of those chapters shall be complied with in addition to the requirements of this Chapter.

4. Reception facilities

M Regulation 12 – Reception facilities

Attention is drawn to the fact that the following regulation is the Danish Maritime Authority's translation of MARPOL. As regards Danish legislation, reference is made to the Ministry of the Environment.

1. The Government of each Party to the Convention, which requires ships operating in waters under its jurisdiction and visiting ships while in its waters to comply with the requirements of regulation 11.1, undertakes to ensure the provision of facilities at ports and terminals for the reception of sewage, without causing delay to ships, adequate to meet the needs of the ships using them.
2. The Government of each Party shall notify the Organization, for transmission to the Contracting Governments concerned, of all cases where the facilities provided under this regulation are alleged to be inadequate.

S Regulation 13 – Port State control on operational requirements⁵

1. A ship when in a port or an offshore terminal of another Party is subject to inspection by officers duly authorized by such Party concerning operational requirements under this Chapter, where there are clear grounds for believing that the master or crew are not familiar with essential shipboard procedures relating to the prevention of pollution by sewage.
2. In the circumstances given in paragraph (1) of this regulation, the Party shall take such steps as will ensure that the ship shall not sail until the situation has been brought to order in accordance with the requirements of this Chapter.
3. Procedures relating to the port State control prescribed in article 5 of the MARPOL Convention shall apply to this regulation.
4. Nothing in this regulation shall be construed to limit the rights and obligations of a Party carrying out control over operational requirements specifically provided for in the MARPOL Convention.

⁵ Refer to procedures for port State control adopted by the Organization by resolution A.787(19) and amended by resolution A.882(21); see IMO sales publication IMO-650E.

Part 2 Storage of sewage in small vessels

S Regulation 1 – Application

These provisions shall apply to all types of vessels with a gross tonnage below 400, or which have been approved for carrying fewer than 15 persons, fitted with a toilet and navigating the Baltic Sea area and Danish territorial waters.

S Regulation 2 – Definition

1. *“New vessel” means a vessel the keel of which is laid or which has been constructed on or after 1 January 2000*
2. *“Existing vessel” means a vessel that is not a new vessel.*
3. *“Sewage” means drainage and other wastes from toilets and urinals.*
4. *“Fixed toilet system” means a toilet system consisting of a lavatory bowl, a holding tank with associated valves and pipes and/or pipe connections as well as a shore connection.*
5. *“Portable toilet” means a toilet system consisting of a lavatory bowl with associated portable holding tank without a sea connection, where it is possible to empty the tank manually by tipping.*
6. *“Shore connection” means a standard connection flange through which it is possible to empty the tank via an external pumping arrangement.*
7. *“Sea toilet” means a toilet system not provided with a holding tank and with direct connection to the sea.*

S Regulation 3 – Requirements for new vessels

Fixed and portable toilet systems shall comply with the technical requirements of the most recent edition of the standard ISO 8099 at the time of construction.

S Regulation 4 – Requirements for existing vessels

1. *Existing vessels shall comply with the requirements of regulation 3 from 1 January 2005, however*
 - 1.1. *existing, portable toilet systems may be retained;*
 - 1.2. *existing, fixed toilet systems shall be retained if the system is fitted with a shore connection in accordance with the standard ISO 8099;*
 - 1.3. *existing sea toilets shall be retained if the toilet is fitted with a holding tank as well as a shore connection in accordance with the standard ISO 8099.*

M Regulation 5 – The use of products for disinfecting and other purposes

Attention is drawn to the fact that the following regulation is the Danish Maritime Authority’s translation of MARPOL. As regards Danish legislation in force, reference is made to the Danish Ministry for the Environment.

In any toilet system, only products that are not harmful to the marine environment may be used for disinfecting and other purposes.

Notice from the Danish Maritime Authority B – The Construction and Equipment, etc. of Ships

Chapter B XXV

Prevention of pollution by garbage from ships

Regulation 1– Definitions	1
Regulation 2– Application	2
M Regulation 3– Disposal of garbage outside special areas.....	2
M Regulation 4– Special requirements for disposal of garbage	3
M Regulation 5 – Disposal of garbage within special areas	3
M Regulation 6 – Exceptions.....	5
M Regulation 7– Reception facilities.....	5
S Regulation 8– Port State control on operational requirements	5
Regulation 9– Placards, garbage management plans and garbage record-keeping	6

Introduction

The provisions of chapter XXV (the previous chapter XXIV) have been drawn up on the basis of annex V to the International Convention for the Prevention of Pollution from Ships – the 1973 MARPOL Convention – as amended.

The administration of the rules has been distributed so that the Danish Environmental Protection Agency is responsible for the rules on discharge, while the Danish Maritime Authority is responsible for the technical installations on board the ships, including the records and plans. This distribution of responsibility has been indicated in the list of content with either an “M” for the Danish Environmental Protection Agency or an “S” for the Danish Maritime Authority.

In connection with the implementation of the provisions of the MARPOL Convention in Denmark, orders have been issued by the Danish Ministry of the Environment in addition to the technical regulations of the Danish Maritime Authority, which shall be followed as well.

In the provisions, the IMO is referred to as the Organisation, MARPOL 73/78 is referred to as the Convention and the Danish Environmental Protection Agency and the Danish Maritime Authority, respectively, are referred to as the Administration.

Regulation 1– Definitions

For the purposes of this Chapter:

1. “Garbage” means all kinds of victual, domestic and operational waste excluding fresh fish and parts thereof, generated during the normal operation of the ship and liable to be disposed of continuously

or periodically except those substances which are defined or listed in other Annexes to the present Convention.

2. "Nearest land". The term "from the nearest land" means from the baseline from which the territorial sea of the territory in question is established in accordance with international law, except that, for the purposes of the present Convention, "from the nearest land" off the north-eastern coast of Australia shall mean from a line drawn from a point on the coast of Australia in

latitude 11°00' S, longitude 142°08' E

to a point in latitude 10°35' S, longitude 141°55' E,

thence to a point latitude 10°00' S, longitude 142° 00' E,

thence to a point latitude 09°10' S, longitude 143° 52' E,

thence to a point latitude 09°00' S, longitude 144° 30' E,

thence to a point latitude 10°41' S, longitude 145° 00' E,

thence to a point latitude 13°00' S, longitude 145° 00' E,

thence to a point latitude 15°00' S, longitude 146° 00' E,

thence to a point latitude 17°30' S, longitude 147° 00' E,

thence to a point latitude 21°00' S, longitude 152° 55' E,

thence to a point latitude 24°30' S, longitude 154° 00' E,

thence to a point on the coast of Australia in latitude 24°42' S, longitude 153°15' E.

3. "Special area" means a sea area where for recognized technical reasons in relation to its oceanographical and ecological condition and to the particular character of its traffic the adoption of special mandatory methods for the prevention of sea pollution by garbage is required. Special areas shall include those listed in regulation 5 of this Chapter.

Regulation 2– Application

Unless expressly provided otherwise, the provisions of this Chapter shall apply to all ships.

M Regulation 3– Disposal of garbage outside special areas

Attention is drawn to the fact that the following regulation is the Danish Maritime Authority's translation of MARPOL. As regards Danish legislation, reference is made to the Ministry of the Environment.

1. Subject to the provisions of regulations 4, 5 and 6 of this Chapter:
 - a) the disposal into the sea of all plastics, including but not limited to synthetic ropes, synthetic fishing nets, plastic garbage bags and incinerator ashes from plastic products which may contain toxic or heavy metal residues, is prohibited;
 - b) the disposal into the sea of the following garbage shall be made as far as practicable from the nearest land but in any case is prohibited if the distance from the nearest land is less than:
 - 1) 25 nautical miles for dunnage, lining and packing materials which will float;
 - 2) 12 nautical miles for food wastes and all other garbage including paper products, rags, glass, metal, bottles, crockery and similar refuse;
 - c) disposal into the sea of garbage specified in subparagraph(b)(ii) of this regulation may be permitted when it has passed through a comminuter or grinder and made as far as practicable

from the nearest land but in any case is prohibited if the distance from the nearest land is less than 3 nautical miles. Such comminuted or ground garbage shall be capable of passing through a screen with openings no greater than 25 mm.

2. When the garbage is mixed with other discharges having different disposal or discharge requirements the more stringent requirements shall apply.

M Regulation 4– Special requirements for disposal of garbage

Attention is drawn to the fact that the following regulation is the Danish Maritime Authority's translation of MARPOL. As regards Danish legislation, reference is made to the Ministry of the Environment.

1. Subject to the provisions of paragraph (2) of this regulation, the disposal of any materials regulated by this Chapter is prohibited from fixed or floating platforms engaged in the exploration, exploitation and associated offshore processing of sea-bed mineral resources, and from all other ships when alongside or within 500 m of such platforms.
2. The disposal into the sea of food wastes may be permitted when they have been passed through a comminuter or grinder from such fixed or floating platforms located more than 12 nautical miles from land and all other ships when alongside or within 500 m of such platforms. Such comminuted or ground food wastes shall be capable of passing through a screen with openings no greater than 25 mm.

M Regulation 5 – Disposal of garbage within special areas

Attention is drawn to the fact that the following regulation is the Danish Maritime Authority's translation of MARPOL. As regards Danish legislation, reference is made to the Ministry of the Environment.

1. For the purposes of this Chapter the special areas are the Mediterranean Sea area, the Baltic Sea area, the Black Sea area, the Red Sea area, the "Gulfs area", the North Sea area, the Antarctic area and the Wider Caribbean Region, including the Gulf of Mexico and the Caribbean Sea, which are defined as follows:
 - a) The Mediterranean Sea area means the Mediterranean Sea proper including the gulfs and seas therein with the boundary between the Mediterranean and the Black Sea constituted by the 41° N parallel and bounded to the west by the Straits of Gibraltar at the meridian 5°36' W.
 - b) The Baltic Sea area means the Baltic Sea proper with the Gulf of Bothnia and the Gulf of Finland and the entrance to the Baltic Sea bounded by the parallel of the Skaw in the Skagerrak at 57°44.8' N.
 - c) The Black Sea area means the Black Sea proper with the boundary between the Mediterranean and the Black Sea constituted by the parallel 41° N.
 - d) The Red Sea area means the Red Sea proper including the Gulfs of Suez and Aqaba bounded at the south by the rhumb line between Ras si Ane (12°28.5' N, 43°19.6' E) and Husn Murad (12°40.4' N, 43°30.2' E).
 - e) The Gulfs area means the sea area located north-west of the rhumb line between Ras al Hadd (22°30' N, 59°48' E) and Ras al Fasteh (25°04' N, 61°25' E).

- f) The North Sea area means the North Sea proper including seas therein with the boundary between:
 - 1) the North Sea southwards of latitude 62° N and eastwards of longitude 4° W;
 - 2) the Skagerrak, the southern limit of which is determined east of the Skaw by latitude 57°44.8' N; and
 - 3) the English Channel and its approaches eastwards of longitude 5° W and northwards of latitude 48°30' N.
 - g) The Antarctic area means the sea area south of latitude 60° S.
 - h) The Wider Caribbean Region, as defined in article 2, paragraph 1 of the Convention for the Protection and Development of the Marine Environment of the Wider Caribbean Region (Cartagena de Indias, 1983), means the Gulf of Mexico and Caribbean Sea proper including the bays and seas therein and that portion of the Atlantic Ocean within the boundary constituted by the 30° N parallel from Florida eastward to 77°30' W meridian, thence a rhumb line to the intersection of 20° N parallel and 59° W meridian, thence a rhumb line to the intersection of 7°20' N parallel and 50° W meridian, thence a rhumb line drawn southwesterly to the eastern boundary of French Guiana.
2. Subject to the provisions of regulation 6 of this Chapter:
- a) disposal into the sea of the following is prohibited:
 - 1) all plastics, including but not limited to synthetic ropes, synthetic fishing nets, plastic garbage bags and incinerator ashes from plastic products which may contain toxic or heavy metal residues; and
 - 2) all other garbage, including paper products, rags, glass, metal, bottles, crockery, dunnage, lining and packing materials;
 - b) except as provided in subparagraph (c) of this paragraph, disposal into the sea of food wastes shall be made as far as practicable from land, but in any case not less than 12 nautical miles from the nearest land;
 - c) disposal into the Wider Caribbean Region of food wastes which have been passed through a comminuter or grinder shall be made as far as practicable from land, but in any case not less than 3 nautical miles from the nearest land. Such comminuted or ground food wastes shall be capable of passing through a screen with openings no greater than 25 mm.
3. When the garbage is mixed with other discharges having different disposal or discharge requirements the more stringent requirements shall apply.
4. Reception facilities within special areas:
- a) The Government of each Party to the Convention, the coastline of which borders a special area, undertakes to ensure that as soon as possible in all ports within a special area adequate reception facilities are provided in accordance with regulation 7 of this Chapter, taking into account the special needs of ships operating in these areas.
 - b) The Government of each Party concerned shall notify the Organization of the measures taken pursuant to subparagraph (a) of this regulation. Upon receipt of sufficient notifications the Organization shall establish a date from which the requirements of this regulation in respect of the area in question shall take effect. The Organization shall notify all Parties of the date so established no less than twelve months in advance of that date.
 - c) After the date so established, ships calling also at ports in these special areas where such facilities are not yet available, shall fully comply with the requirements of this regulation.
5. Notwithstanding paragraph 4 of this regulation, the following rules apply to the Antarctic area:

- a) The Government of each Party to the Convention at whose ports ships depart *en route* to or arrive from the Antarctic area undertakes to ensure that as soon as practicable adequate facilities are provided for the reception of all garbage from all ships, without causing undue delay, and according to the needs of the ships using them.
- b) The Government of each Party to the Convention shall ensure that all ships entitled to fly its flag, before entering the Antarctic area, have sufficient capacity on board for the retention of all garbage while operating in the area and have concluded arrangements to discharge such garbage at a reception facility after leaving the area.

M Regulation 6 – Exceptions

Attention is drawn to the fact that the following regulation is the Danish Maritime Authority's translation of MARPOL. As regards Danish legislation, reference is made to the Ministry of the Environment.

Regulations 3, 4 and 5 of this Chapter shall not apply to:

- a) the disposal of garbage from a ship necessary for the purpose of securing the safety of a ship and those on board or saving life at sea; or
- b) the escape of garbage resulting from damage to a ship or its equipment provided all reasonable precautions have been taken before and after the occurrence of the damage, for the purpose of preventing or minimizing the escape; or
- c) the accidental loss of synthetic fishing nets, provided that all reasonable precautions have been taken to prevent such loss.

M Regulation 7– Reception facilities

Attention is drawn to the fact that the following regulation is the Danish Maritime Authority's translation of MARPOL. As regards Danish legislation, reference is made to the Ministry of the Environment...

1. The Government of each Party to the Convention undertakes to ensure the provision of facilities at ports and terminals for the reception of garbage, without causing undue delay to ships, and according to the needs of the ships using them.
2. The Government of each Party shall notify the Organization for transmission to the Parties concerned of all cases where the facilities provided under this regulation are alleged to be inadequate.

S Regulation 8– Port State control on operational requirements¹⁾

(1) A ship when in a port of another Party is subject to inspection by officers duly authorized by such Party concerning operational requirements under this Chapter, where there are clear grounds for believing that the master or crew are not familiar with essential shipboard procedures relating to the prevention of pollution by garbage.

¹⁾ Refer to the Procedures for port State control adopted by the Organization by resolution A.787(19) and amended by A.882(21);

(2) In the circumstances given in paragraph (1) of this regulation, the Party shall take such steps as will ensure that the ship shall not sail until the situation has been brought to order in accordance with the requirements of this Chapter.

(3) Procedures relating to the port State control prescribed in article 5 of the present Convention shall apply to this regulation.

(4) Nothing in this regulation shall be construed to limit the rights and obligations of a Party carrying out control over operational requirements specifically provided for in the present Convention.

Regulation 9– Placards, garbage management plans and garbage record-keeping

1.

a) Every ship of 12 m or more in length overall shall display placards which notify the crew and passengers of the disposal requirements of regulations 3 and 5 of this Chapter, as applicable. *Appendix 2 to this chapter contains an example of such a placard.*

b) The placards shall be written in the working language of the ship's personnel and, for ships engaged in voyages to ports or offshore terminals under the jurisdiction of other Parties to the Convention, shall also be in English, French or Spanish.

c) *The placard shall be placed in conspicuous places where passengers and crewmembers move about in general as well as in galleys where stores are unpacked, where garbage is sorted, stored and treated and in similar places.*

2. Every ship of 400 gross tonnage and above, and every ship which is certified to carry 15 persons or ore, shall carry a garbage management plan which the crew shall follow. This plan shall provide written procedures for collecting, storing, processing and disposing of garbage, including the use of the equipment on board. It shall also designate the person in charge of carrying out the plan. Such a plan shall be in accordance with the guidelines developed by the Organization* and written in the working language of the crew.

3. Every ship of 400 gross tonnage and above and every ship which is certified to carry 15 persons or more engaged in voyages to ports or offshore terminals under the jurisdiction of other Parties to the Convention and every fixed and floating platform engaged in exploration and exploitation of the seabed shall be provided with a Garbage Record Book. The Garbage Record Book, whether as a part of the ship's official log-book or otherwise, shall be in the form specified in the appendix to this Chapter (*not included here*);

a) each discharge operation, or completed incineration, shall be recorded in the Garbage Record Book and signed for on the date of the incineration or discharge by the officer in charge. Each completed page of the Garbage Record Book shall be signed by the master of the ship. The entries in the Garbage Record Book shall be at least in English, French or Spanish. Where the entries are also made in an official language of the State whose flag the ship is entitled to fly, these entries shall prevail in case of a dispute or discrepancy;

b) the entry for each incineration or discharge shall include date and time, position of the ship, description of the garbage and the estimated amount incinerated or discharged;

c) (c) the Garbage Record Book shall be kept on board the ship and in such a place as to be available for inspection in a reasonable time. This document shall be preserved for a period of two years after the last entry is made on the record;

- d) in the event of discharge, escape or accidental loss referred to in regulation 6 of this Chapter an entry shall be made in the Garbage Record Book of the circumstances of, and the reasons for, the loss.
 - e) *The garbage record shall be kept in an easily legible hand, and no page may be torn out. What has been recorded once may not be erased, crossed out or in any other way be made illegible. If it becomes necessary to correct anything in the record, the correction shall be added as a remark.*
4. The Administration may waive the requirements for Garbage Record Books for:
 - a) any ship engaged on voyages of 1 hour or less in duration which is certified to carry 15 persons or more (*the Danish Maritime Authority shall in general waive the requirement of paragraph (i)*); or
 - b) fixed or floating platforms while engaged in exploration and exploitation of the sea-bed.
 5. The competent authority of the Government of a Party to the Convention may inspect the Garbage Record Book on board any ship to which this regulation applies while the ship is in its ports or offshore terminals and may make a copy of any entry in that book, and may require the master of the ship to certify that the copy is a true copy of such an entry. Any copy so made, which has been certified by the master of the ship as a true copy of an entry in the ship's Garbage Record Book, shall be admissible in any judicial proceedings as evidence of the facts stated in the entry. The inspection of a Garbage Record Book and the taking of a certified copy by the competent authority under this paragraph shall be performed as expeditiously as possible without causing the ship to be unduly delayed.
 6. In the case of ships built before 1 July 1997, this regulation shall apply as from 1 July 1998.
 7.
 - a) *All ships shall be provided with storage facilities of a capacity sufficient to store solid garbage on board as well as food waste in consideration of the relevant ship's area of operation and sailing time to ports that are capable of receiving the garbage. The ships shall, as a minimum, be provided with storage facilities of a capacity as indicated in appendix 1.*
 - b) *In all passenger ships, garbage containers shall be placed at suitable places in the galley and on open deck at a suitable distance from each other.*
 8. *On ships built after 1 January 1997, garbage incinerators shall comply with the provisions of resolution MEPC.59(33), "Standard specification for shipboard incinerators".*

* Refer to the Guidelines for the development of garbage management plans adopted by the Marine Environment Protection Committee of the Organization by resolution MEPC.71(38);

Appendix 1

Guidelines for the capacity of garbage containers

Gross tonnage and number of persons	Min. capacity of garbage containers (m³)
< 400 with up to ten persons	0.1
< 400 with up to 50 persons	0.5
400 – 1,600	0.4
1600 – 4,000	1.2
4000 – 10,000	2.5
10,000 and above	5.0
<i>Ships carrying more than 50 persons</i>	<i>1.0 m³ per 100 persons a day</i>

The ships shall be provided with three garbage containers in accordance with the three garbage categories stipulated in the "Guidelines for the implementation of Annex V of MARPOL 73/78". In general, garbage may be expected to consist of 50 per cent glass, cardboard, paper, etc., 25 per cent plastic and 25 per cent foodstuffs.

The garbage container capacity may be reduced for ships that sail only on two ports or that have a short sailing time or that are provided with garbage incinerators or compactor and grinding plants.

Appendix 2

Guidelines for placards on the treatment of garbage on board

Example of the placard on garbage required by regulation 9, paragraph 1:

<p>Garbage from ships shall be sorted in accordance with the table below and shall be stored in containers on board.</p> <p>All garbage from ships shall, insofar as possible, be delivered to reception facilities ashore.</p> <p>Legal discharge of garbage from ships into the sea may take place only in accordance with the table below and after permission from the ship's captain or officers.</p> <p>Illegal discharge of garbage into the sea will be punished.</p>		
Garbage	Outside special sea areas	Special sea areas
All types of plastics, including synthetic ropes and fishing nets as well as garbage bags	Prohibited	Prohibited
Floating dunnage, lining and packing materials	25 nautical miles from the nearest land	Prohibited
Paper, rags, glass, metal, bottles, crockery and similar materials	12 nautical miles from the nearest land	Prohibited
Food waste	12 nautical miles from the nearest land	12 nautical miles from the nearest land

Notice from the Danish Maritime Authority B – The Construction and Equipment, etc. of Ships

Chapter B XXVI

Regulations for the Prevention of Air Pollution from Ships

Regulation 1 – Application	2
Regulation 2 – Definitions	2
Regulation 3 – Exceptions and exemptions	4
M/S Regulation 4 – Equivalents	5
S Regulation 5 – Surveys	5
S Regulation 6 – Issue or endorsement of a Certificate	7
S Regulation 7 – Issue of a Certificate by another Party	7
S Regulation 8 – Form of Certificate	7
S Regulation 9 – Duration and validity of Certificate	8
S Regulation 10 – Port State control on operational requirements	9
S/M Regulation 11 – Detection of violations and enforcement	9
M Regulation 12 – Ozone-depleting substances	10
S Regulation 13 – Nitrogen oxides (NO _x)	11
S/M Regulation 14 – Sulphur oxides (SO _x) and particulate matter	15
M Regulation 15 – Volatile organic compounds	17
S/M Regulation 16 – Shipboard incineration	18
(M) Regulation 17 – Reception facilities	19
S/M Regulation 18 – Fuel oil availability and quality	19

Introduction

The provisions of this chapter have been drawn up on the basis of annex VI to the International Convention for the Prevention of Pollution from Ships – the 73/78 MARPOL Convention – as adopted by the 1997 Protocol at the International Conference for the Parties to MARPOL 73/78 in September 1997.

The administration of the rules has been distributed so that the Danish Environmental Protection Agency is responsible for the rules on discharge, while the Danish Maritime Authority is responsible for the technical installations on board the ships, including the records and plans. This distribution of responsibility has been indicated in the list of content with either an “M” for the Danish Environmental Protection Agency or an “S” for the Danish Maritime Authority.

In connection with the implementation of the provisions of the MARPOL Convention in Denmark, orders have been issued by the Danish Ministry of the Environment in addition to the technical regulations of the Danish Maritime Authority, which shall be followed as well.

In the provisions, the IMO is referred to as the Organization, MARPOL 73/78 is referred to as the Convention and the Danish Environmental Protection Agency and the Danish Maritime Authority, respectively, are referred to as the Administration.

The chapter is issued with similar wording in the regulations Notice B, D, E and F of the DMA, and may consequently be inserted in each of the mentioned regulations.

Part 1 – General

Regulation 1 – Application

The provisions of this Chapter shall apply to all ships, except where expressly provided otherwise in regulations 3, 5, 6, 13, 15, 16 and 18 of this Chapter. *The regulations shall not apply to ships registered in Greenland.*

Regulation 2 – Definitions

For the purpose of this Chapter:

1. “Chapter” means Chapter VI to the International Convention for the Prevention of Pollution from Ships 1973 (MARPOL), as modified by the Protocol of 1978 relating thereto, and as modified by the Protocol of 1997, as amended by the Organization, provided that such amendments are adopted and brought into force in accordance with the provisions of article 16 of the MARPOL Convention.
2. A “similar stage of construction” means the stage at which:
 - 2.1. construction identifiable with a specific ship begins; and
 - 2.2. assembly of that ship has commenced comprising at least 50 tons or one per cent of the estimated mass of all structural material, whichever is less.
3. “Anniversary date” means the day and the month of each year which will correspond to the date of expiry of the International Air Pollution Prevention Certificate.
4. “Auxiliary control device” means a system, function, or control strategy installed on a marine diesel engine that is used to protect the engine and/or its ancillary equipment against operating conditions that could result in damage or failure, or that is used to facilitate the starting of the engine. An auxiliary control device may also be a strategy or measure that has been satisfactorily demonstrated not to be a defeat device.
5. “Continuous feeding” is defined as the process whereby waste is fed into a combustion chamber without human assistance while the incinerator is in normal operating conditions with the combustion chamber operative temperature between 850°C and 1200°C.
6. “Defeat device” means a device which measures, senses, or responds to operating variables (e.g., engine speed, temperature, intake pressure or any other parameter) for the purpose of activating, modulating, delaying or deactivating the operation of any component or the function of the emission control system such that the effectiveness of the emission control system is reduced under conditions encountered during normal operation, unless the use of such a device is substantially included in the applied emission certification test procedures.
7. “Emission” means any release of substances, subject to control by this Chapter, from ships into the atmosphere or sea.
8. “Emission control area” means an area where the adoption of special mandatory measures for emissions from ships is required to prevent, reduce and control air pollution from NO_x or SO_x and

particulate matter or all three types of emissions and their attendant adverse impacts on human health and the environment. Emission control areas shall include those listed in, or designated under, regulations 13 and 14 of this Chapter.

9. "Fuel oil" means any fuel delivered to and intended for combustion purposes for propulsion or operation on board a ship, including distillate and residual fuels.
10. "Gross tonnage" means the gross tonnage calculated in accordance with the tonnage measurement regulations contained in Annex I to the International Convention on Tonnage Measurements of Ships, 1969 or any successor Convention.
11. "Installations" in relation to regulation 12 of this Chapter means the installation of systems, equipment including portable fire-extinguishing units, insulation, or other material on a ship, but excludes the repair or recharge of previously installed systems, equipment, insulation, or other material, or the recharge of portable fire-extinguishing units.
12. "Installed" means a marine diesel engine that is or is intended to be fitted on a ship, including a portable auxiliary marine diesel engine, only if its fuelling, cooling, or exhaust system is an integral part of the ship. A fuelling system is considered integral to the ship only if it is permanently affixed to the ship. This definition includes a marine diesel engine that is used to supplement or augment the installed power capacity of the ship and is intended to be an integral part of the ship.
13. "Irrational emission control strategy" means any strategy or measure that, when the ship is operated under normal conditions of use, reduces the effectiveness of an emission control system to a level below that expected on the applicable emission test procedures.
14. "Marine diesel engine" means any reciprocating internal combustion engine operating on liquid or dual fuel, to which regulation 13 of this chapter applies, including booster/compound systems if applied.
15. "NO_x Technical Code" means the Technical Code on Control of Emission of Nitrogen Oxides from Marine Diesel Engines adopted by resolution 2 of the 1997 MARPOL Conference, as amended by the Organization, provided that such amendments are adopted and brought into force in accordance with the provisions of article 16 of the MARPOL Convention.
16. "Ozone-depleting substances" means controlled substances defined in paragraph 4 of article 1 of the Montreal Protocol on Substances that Deplete the Ozone Layer, 1987, listed in Annexes A, B, C or E to the said Protocol in force at the time of application or interpretation of this Chapter.

Ozone-depleting substances that may be found on board ship include, but are not limited to:

Halon 1211	Bromochlorodifluoromethane
Halon 1301	Bromotrifluoromethane
Halon 2402	1,2-Dibromo-1,1,2,2-tetrafluoroethane (also known as Halon 114B2)
CFC-11	Trichlorofluoromethane
CFC-12	Dichlorodifluoromethane
CFC-113	1,1,2-Trichloro-1,2,2-trifluoroethane
CFC-114	1,2-Dichloro-1,1,2,2-tetrafluoroethane
CFC-115	Chloropentafluoroethane

17. "Shipboard incineration" means the incineration of wastes or other matter on board a ship, if such wastes or other matter were generated during the normal operation of that ship.
18. "Shipboard incinerator" means a shipboard facility designed for the primary purpose of incineration.

19. "Ships constructed" means ships the keels of which are laid or which are at a similar stage of construction.
20. "Sludge oil" means sludge from the fuel oil or lubricating oil separators, waste lubricating oil from main or auxiliary machinery, or waste oil from bilge water separators, oil filtering equipment or drip trays.
21. "Tanker" means an oil tanker as defined in regulation 1 of Notice from the Danish Maritime Authority B, chapter XXI, or a chemical tanker as defined in regulation 1 of Notice from the Danish Maritime Authority B, chapter XXII.

Regulation 3 – Exceptions and exemptions

General

1. Regulations of this Chapter shall not apply to:
 - 1.1. any emission necessary for the purpose of securing the safety of a ship or saving life at sea; or
 - 1.2. any emission resulting from damage to a ship or its equipment:
 - 1.2.1. provided that all reasonable precautions have been taken after the occurrence of the damage or discovery of the emission for the purpose of preventing or minimizing the emission; and
 - 1.2.2. except if the owner or the master acted either with intent to cause damage, or recklessly and with knowledge that damage would probably result.

Trials for ship emission reduction and control technology research

2. The Administration of a Party may, in co-operation with other Administrations as appropriate, issue and exemption from specific provisions of this chapter for a ship to conduct trials for the development of ship emission reduction and control technologies and engine design programmes. Such an exemption shall only be provided if the applications of specific provisions of the chapter or the revised NO_x Technical Code 2008 could impede research into the development of such technologies or programmes. A permit for such an exemption shall only be provided to the minimum number of ships necessary and be subject to the following provisions:
 - 2.1. for marine diesel engines with a per cylinder displacement up to 30 litres, the duration of the sea trial shall not exceed 18 months. If additional time is required, a permitting Administration or Administrations may permit a renewal for one additional 18-month period; or
 - 2.2. for marine diesel engines with a per cylinder displacement at or above 30 litres, the duration of the ship trial shall not exceed 5 years and shall require a progress review by the permitting Administration or Administrations at each intermediate survey. A permit may be withdrawn based on this review if the testing has not adhered to the conditions of permit or if it is determined that the technology or programme is not likely to produce effective results in the reduction and control of ship emissions. If the reviewing Administration or Administrations determine that additional time is required to conduct a test of a particular technology or programme, a permit may be renewed for an additional time period not to exceed five years.

Emissions from sea-bed mineral activities

- 3.1 Emissions directly arising from the exploration, exploitation and associated offshore processing of sea-bed mineral resources are, consistent with article 2(3)(b)(ii) of the MARPOL Convention, exempt from the provisions of this chapter. Such emissions include the following:
- 3.1.1 emissions resulting from the incineration of substances that are solely and directly the result of exploration, exploitation and associated offshore processing of sea-bed mineral resources, including but not limited to the flaring of hydrocarbons and the burning of cuttings, muds, and/or stimulation fluids during well completion and testing operations, and flaring arising from upset conditions;
 - 3.1.2 the release of gases and volatile compounds entrained in drilling fluids and cuttings;
 - 3.1.3 emissions associated solely and directly with the treatment, handling, or storage of sea-bed minerals; and
 - 3.1.4 emissions from marine diesel engines that are solely dedicated to the exploration, exploitation and associated offshore processing of sea-bed mineral resources.
- 3.2 The requirements of regulation 18 of this chapter shall not apply to the use of hydrocarbons which are produced and subsequently used on site as fuel, when approved by the Administration.

M/S Regulation 4 – Equivalents

1. The Administration of a Party may allow any fitting, material, appliance or apparatus to be fitted in a ship or other procedures, alternative fuel oils, or compliance methods used as an alternative to that required by this Chapter if such fitting, material, appliance or apparatus or other procedures, alternative fuel oils, or compliance methods are at least as effective in terms of emissions reductions as that required by this Chapter, including any of the standards set forth in regulations 13 and 14.
2. The Administration of a Party which allows a fitting, material, appliance or apparatus or other procedures, alternative fuel oils, or compliance methods used as an alternative to that required by this Chapter shall communicate to the Organization for circulation to the Parties particulars thereof, for their information and appropriate action, if any.
3. The Administration of a Party should take into account any relevant guidelines developed by the Organization pertaining to the equivalents provided for in this regulation.
4. The Administration of a Party which allows the use of an equivalent as set forth in paragraph of this regulation shall endeavour not to impair or damage its environment, human health, property, or resources or those of other States.

Part II – Survey, certification and means of control

S Regulation 5 – Surveys

1. Every ship of 400 gross tonnage and above and every fixed and floating drilling rig and other platforms shall be subject to the surveys specified below:
 - 1.1. An initial survey before the ship is put into service or before the certificate required under regulation 6 of this Chapter is issued for the first time. This survey shall be such as to ensure that the equipment, systems, fittings, arrangements and material fully comply with the applicable requirements of this Chapter;
 - 1.2. A renewal survey at intervals specified by the Administration, but not exceeding five years, except where regulation 9.2, 9.5, 9.6 or 9.7 of this Chapter is applicable. The renewal survey

shall be such as to ensure that the equipment, systems, fittings, arrangements and material fully comply with applicable requirements of this Chapter;

- 1.3. An intermediate survey within three months before or after the second anniversary date or within three months before or after the third anniversary date of the certificate which shall take the place of one of the annual surveys specified in paragraph 1.4 of this regulation. The intermediate survey shall be such as to ensure that the equipment and arrangements fully comply with the applicable requirements of this Chapter and are in good working order. Such intermediate surveys shall be endorsed on the certificate issued under regulation 6 or 7 of this Chapter;
 - 1.4. An annual survey within three months before or after each anniversary date of the certificate, including a general inspection of the equipment, systems, fittings, arrangements and material referred to in paragraph 1.1 of this regulation to ensure that they have been maintained in accordance with paragraph 4 of this regulation and that they remain satisfactory for the service for which the ship is intended. Such annual surveys shall be endorsed on the certificate issued under regulation 6 or 7 of this Chapter; and
 - 1.5. An additional survey either general or partial, according to the circumstances, shall be made whenever any important repairs or renewals are made as prescribed in paragraph 4 of this regulation or after a repair resulting from investigations prescribed in paragraph 5 of this regulation. The survey shall be such as to ensure that the necessary repairs or renewals have been effectively made, that the material and workmanship of such repairs or renewals are in all respects satisfactory and that the ship complies in all respects with the requirements of this Chapter.
2. In the case of ships of less than 400 gross tonnage, the Administration may establish appropriate measures in order to ensure that the applicable provisions of this Chapter are complied with.
 3. Surveys of ships as regards the enforcement of the provisions of this chapter shall be carried out by officers of the Administration.
 - 3.1. The Administration may, however, entrust the surveys either to surveyors nominated for the purpose or to organizations recognized by it. Such organizations shall comply with the guidelines adopted by the Organization;¹⁾
 - 3.2. The survey of marine diesel engines and equipment for compliance with regulation 13 of this Chapter shall be conducted in accordance with the revised NO_x Technical Code 2008;
 - 3.3. When a nominated surveyor or recognized organization determines that the condition of the equipment does not correspond substantially with the particulars of the certificate, they shall ensure that corrective action is taken and shall in due course notify the Administration. If such corrective action is not taken, the certificate shall be withdrawn by the Administration. If the ship is in a port of another Party, the appropriate authorities of the port State shall also be notified immediately. When an officer of the Administration, a nominated surveyor or recognized organization has notified the appropriate authorities of the port State, the Government of the port State concerned shall give such officer, surveyor or organization any necessary assistance to carry out their obligations under this regulation; and

¹⁾ Refer to the Guidelines for the authorization of organizations acting on behalf of the Administration, adopted by the Organization by resolution A.739 (18), as may be amended by the Organization, and the Specifications on the survey and certification functions of recognized organizations acting on behalf of the Administration, adopted by the Organization by resolution A.789(19), as may be amended by the Organization.

- 3.4. In every case, the Administration concerned shall fully guarantee the completeness and efficiency of the survey and shall undertake to ensure the necessary arrangements to satisfy this obligation.
4. The equipment shall be maintained to conform with the provisions of this Chapter and no changes shall be made in the equipment, systems, fittings, arrangements, or material covered by the survey, without the express approval of the Administration. The direct replacement of such equipment and fittings with equipment and fittings that conform with the provisions of this Chapter is permitted.
5. Whenever an accident occurs to a ship or a defect is discovered which substantially affects the efficiency or completeness of its equipment covered by this Chapter, the master or owner of the ship shall report at the earliest opportunity to the Administration, a nominated surveyor, or recognized organization responsible for issuing the relevant certificate.

S Regulation 6 – Issue or endorsement of a Certificate

1. An International Air Pollution Prevention Certificate shall be issued, after an initial or renewal survey in accordance with the provisions of regulation 5 of this Chapter, to:
 - 1.1. any ship of 400 gross tonnage and above engaged in *domestic voyages or* to ports or offshore terminals under the jurisdiction of other Parties; and
 - 1.2. platforms and drilling rigs engaged in *domestic voyages or* to waters under the sovereignty or jurisdiction of other Parties.
2. A ship constructed before 19 May 2005 shall be issued with an International Air Pollution Prevention Certificate in accordance with paragraph 1 of this regulation no later than the first scheduled dry-docking after 19 May 2005, but in no case later than 19 May 2008.
3. Such certificate shall be issued or endorsed either by the Administration or by any person or organization duly authorized by it. In every case, the Administration assumes full responsibility for the certificate.

S Regulation 7 – Issue of a Certificate by another Party

1. A Party may, at the request of the Administration, cause a ship to be surveyed and, if satisfied that the provisions of this Chapter are complied with, shall issue or authorize the issuance of an International Air Pollution Prevention Certificate to the ship, and where appropriate, endorse or authorize the endorsement of that certificate on the ship, in accordance with this Chapter.
2. A copy of the certificate and a copy of the survey report shall be transmitted as soon as possible to the requesting Administration.
3. A certificate so issued shall contain a statement to the effect that it has been issued at the request of the Administration and it shall have the same force and receive the same recognition as a certificate issued under regulation 6 of this Chapter.
4. No International Air Pollution Prevention Certificate shall be issued to a ship which is entitled to fly the flag of a State which is not a Party.

S Regulation 8 – Form of Certificate

The International Air Pollution Prevention Certificate shall be drawn up in a form corresponding to the model given in appendix I to this Chapter (*see appendix 1C to Notice B from the DMA*) and shall be at least in English, French or Spanish. If an official language of the issuing country is also used, this shall prevail in case of a dispute or discrepancy.

S Regulation 9 – Duration and validity of Certificate

1. An International Air Pollution Prevention Certificate shall be issued for a period specified by the Administration, which shall not exceed five years.
2. Notwithstanding the requirements of paragraph 1 of this regulation:
 - 2.1. when the renewal survey is completed within three months before the expiry date of the existing certificate, the new certificate shall be valid from the date of completion of the renewal survey to a date not exceeding five years from the date of expiry of the existing certificate;
 - 2.2. when the renewal survey is completed after the expiry date of the existing certificate, the new certificate shall be valid from the date of completion of the renewal survey to a date not exceeding five years from the date of expiry of the existing certificate; and
 - 2.3. when the renewal survey is completed more than three months before the expiry date of the existing certificate, the new certificate shall be valid from the date of completion of the renewal survey to a date not exceeding five years from the date of completion of the renewal survey.
3. If a certificate is issued for a period of less than five years, the Administration may extend the validity of the certificate beyond the expiry date to the maximum period specified in paragraph 1 of this regulation, provided that the surveys referred to in regulations 5.1.3 and 5.1.4 of this Chapter applicable when a certificate is issued for a period of five years are carried out as appropriate.
4. If a renewal survey has been completed and a new certificate cannot be issued or placed on board the ship before the expiry date of the existing certificate, the person or organization authorized by the Administration may endorse the existing certificate and such a certificate shall be accepted as valid for a further period which shall not exceed five months from the expiry date.
5. If a ship, at the time when a certificate expires, is not in a port in which it is to be surveyed, the Administration may extend the period of validity of the certificate but this extension shall be granted only for the purpose of allowing the ship to complete its voyage to the port in which it is to be surveyed, and then only in cases where it appears proper and reasonable to do so. No certificate shall be extended for a period longer than three months, and a ship to which an extension is granted shall not, on its arrival in the port in which it is to be surveyed, be entitled by virtue of such extension to leave that port without having a new certificate. When the renewal survey is completed, the new certificate shall be valid to a date not exceeding five years from the date of expiry of the existing certificate before the extension was granted.
6. A certificate issued to a ship engaged on short voyages which has not been extended under the foregoing provisions of this regulation may be extended by the Administration for a period of grace of up to one month from the date of expiry stated on it. When the renewal survey is completed, the new certificate shall be valid to a date not exceeding five years from the date of expiry of the existing certificate before the extension was granted.
7. In special circumstances, as determined by the Administration, a new certificate need not be dated from the date of expiry of the existing certificate as required by paragraph 2.1.5 or 6 of this regulation. In these special circumstances, the new certificate shall be valid to a date not exceeding five years from the date of completion of the renewal survey.
8. If an annual or intermediate survey is completed before the period specified in regulation 5 of this Chapter, then:

- 8.1. the anniversary date shown on the certificate shall be amended by endorsement to a date which shall not be more than three months later than the date on which the survey was completed;
 - 8.2. the subsequent annual or intermediate survey required by regulation 5 of this Chapter shall be completed at the intervals prescribed by that regulation using the new anniversary date; and
 - 8.3. the expiry date may remain unchanged provided one or more annual or intermediate surveys, as appropriate, are carried out so that the maximum intervals between the surveys prescribed by regulation 5 of this Chapter are not exceeded.
9. A certificate issued under regulation 6 or 7 of this Chapter shall cease to be valid in any of the following cases:
- 9.1. if the relevant surveys are not completed within the periods specified under regulation 5.1 of this Chapter;
 - 9.2. if the certificate is not endorsed in accordance with regulation 5.1.3 or 5.1.4 of this Chapter;
 - 9.3. upon transfer of the ship to the flag of another State. A new certificate shall only be issued when the Government issuing the new certificate is fully satisfied that the ship is in compliance with the requirements of regulation 5.4 of this Chapter. In the case of a transfer between Parties, if requested within three months after the transfer has taken place, the Government of the Party whose flag the ship was formerly entitled to fly shall, as soon as possible, transmit to the Administration copies of the certificate carried by the ship before the transfer and, if available, copies of the relevant survey reports.

S Regulation 10 – Port State control on operational requirements

1. A ship, when in a port or an offshore terminal under the jurisdiction of another Party, is subject to inspection by officers duly authorized by such Party concerning operational requirements under this Chapter, where there are clear grounds for believing that the master or crew are not familiar with essential shipboard procedures relating to the prevention of air pollution from ships.
2. In the circumstances given in paragraph 1 of this regulation, the Party shall take such steps as to ensure that the ship shall not sail until the situation has been brought to order in accordance with the requirements of this Chapter.
3. Procedures relating to the port State control prescribed in article 5 of the MARPOL Convention shall apply to this regulation.
4. Nothing in this regulation shall be construed to limit the rights and obligations of a Party carrying out control over operational requirements specifically provided for in the MARPOL Convention.

S/M Regulation 11 – Detection of violations and enforcement

1. Parties shall co-operate in the detection of violations and the enforcement of the provisions of this Chapter, using all appropriate and practicable measures of detection and environmental monitoring, adequate procedures for reporting and accumulation of evidence.
2. A ship to which this Chapter applies may, in any port or offshore terminal of a Party, be subject to inspection by officers appointed or authorized by that Party for the purpose of verifying whether the ship has emitted any of the substances covered by this Chapter in violation of the provision of this Chapter. If an inspection indicates a violation of this Chapter, a report shall be forwarded to the Administration for any appropriate action.

3. Any Party shall furnish to the Administration evidence, if any, that the ship has emitted any of the substances covered by this Chapter in violation of the provisions of this Chapter. If it is practicable to do so, the competent authority of the former Party shall notify the master of the ship of the alleged violation.
4. Upon receiving such evidence, the Administration so informed shall investigate the matter, and may request the other Party to furnish further or better evidence of the alleged contravention. If the Administration is satisfied that sufficient evidence is available to enable proceedings to be brought in respect of the alleged violation, it shall cause such proceedings to be taken in accordance with its law as soon as possible. The Administration shall promptly inform the Party which has reported the alleged violation, as well as the Organization, of the action taken.
5. A Party may also inspect a ship to which this Chapter applies when it enters the ports or offshore terminals under its jurisdiction, if a request for an investigation is received from any Party together with sufficient evidence that the ship has emitted any of the substances covered by the Chapter in any place in violation of this Chapter. The report of such investigation shall be sent to the Party requesting it and to the Administration so that the appropriate action may be taken under the present Convention.
6. The international law concerning the prevention, reduction, and control of pollution of the marine environment from ships, including that law relating to enforcement and safeguards, in force at the time of application or interpretation of this Chapter, applies, *mutatis mutandis*, to the rules and standards set forth in this Chapter.

Part III – Requirements for control of emissions from ships

M Regulation 12 – Ozone-depleting substances

Attention is drawn to the fact that the following regulation is only the Danish Maritime Authority's translation of MARPOL. As regards Danish legislation, reference is made to the Ministry of the Environment.

1. This regulation does not apply to permanently sealed equipment where there are no refrigerant charging connections or potentially removable components containing ozone depleting substances.
2. Subject to the provisions of regulation 3.1, any deliberate emissions of ozone-depleting substances shall be prohibited. Deliberate emissions include emissions occurring in the course of maintaining, servicing, repairing or disposing of systems or equipment, except that deliberate emissions do not include minimal releases associated with the recapture or recycling of an ozone-depleting substance. Emissions arising from leaks of an ozone-depleting substance, whether or not the leaks are deliberate, may be regulated by Parties.
- 3.1 Installations which contain ozone-depleting substances, other than hydro-chlorofluorocarbons, shall be prohibited:
 - 3.1.1 on ships constructed on or after 19 May 2005; or
 - 3.1.2 in the case of ships constructed before 19 May 2005, which have a contractual delivery date of the equipment to the ship on or after 19 May 2005 or, in the absence of a contractual delivery date, the actual delivery of the equipment to the ship on or after 19 May 2005.

*This exception shall not apply to ships registered in Denmark.*²⁾

3.2 Installations which contain hydro-chlorofluorocarbons shall be prohibited:

3.2.1 on ships constructed on or after 1 January 2020; or

3.2.2 in the case of ships constructed before 1 January 2020, which have a contractual delivery date of the equipment to the ship on or after 1 January 2020 or, in the absence of a contractual delivery date, the actual delivery date of the equipment to the ship on or after 1 January 2020.

4 The substances referred to in this regulation, and equipment containing such substances, shall be delivered to appropriate reception facilities when removed from ships.

5 Each ship subject to regulation 6.1 shall maintain a list of equipment containing ozone depleting substances.¹

6 Each ship subject to regulation 6.1 which has rechargeable systems that contain ozone depleting substances shall maintain an Ozone Depleting Substance Record Book. This Record Book may form part of an existing log-book or electronic recording system as approved by the Administration.

7 Entries in the Ozone Depleting Substances Record Book shall be recorded in terms of mass (kg) of substance and shall be completed without delay on each occasion, in respect of the following:

7.1 recharge, full or partial, of equipment containing ozone depleting substances;

7.2 repair or maintenance of equipment containing ozone depleting substances;

7.3 discharge of ozone depleting substances to the atmosphere:

7.3.1 deliberate; and

7.3.2 non-deliberate;

7.4 discharge of ozone depleting substances to land-based reception facilities; and

7.5 supply of ozone depleting substances to the ship.

S Regulation 13 – Nitrogen oxides (NO_x)

Application

1.

1.1. This regulation shall apply to:

1.1.1. each marine diesel engine with a power output of more than 130 kW which is installed on a ship; and

1.1.2. each marine diesel engine with a power output of more than 130 kW which undergoes a major conversion on or after 1 January 2000, except when demonstrated to the satisfaction of the Administration that such engine is an identical replacement to the engine which it is replacing and is otherwise not covered under paragraph 1.1.1 of this regulation.

1.2. This regulation does not apply to:

1.2.1. a marine diesel engine intended to be used solely for emergencies, or solely to power any device or equipment intended to be used solely for emergencies on the ship on which it is installed, or a marine diesel engine installed in lifeboats intended to be used solely for emergencies; and

²⁾ HCFC is no longer allowed in EU flagged ships, cf. EC Regulation no. 2037/2000 on substances that deplete the ozone layer.

¹ See Appendix I, Supplement to International Air Pollution Prevention Certificate (IAPP Certificate), section 2.1.

- 1.2.2. a marine diesel engine installed on a ship solely engaged in voyages within waters subject to the sovereignty or jurisdiction of the State the flag of which the ship is entitled to fly, provided that such engine is subject to an alternative NO_x control measure established by the Administration.
- 1.3. Notwithstanding the provisions of subparagraph 1.1 of this paragraph, the Administration may provide an exclusion from the application of this regulation for any marine diesel engine which is installed on a ship constructed, or for any marine diesel engine which undergoes a major conversion before 19 May 2005, provided that the ship on which the engine is installed is solely engaged in voyages to ports or offshore terminals within the State the flag of which the ship is entitled to fly.

Major conversion

2.

- 2.1. For the purpose of this regulation, major conversion means a modification on or after 1 January 2000 of a marine diesel engine that has not already been certified to the standards set forth in paragraph 3, 4, or 5.1.1 of this regulation where:
 - 2.1.1. the engine is replaced by a marine diesel engine or an additional marine diesel engine is installed, or
 - 2.1.2. any substantial modification, as defined in the revised NO_x Technical Code 2008, is made to the engine, or
 - 2.1.3. the maximum continuous rating of the engine is increased by more than 10% compared to the maximum continuous rating of the original certification of the engine.
- 2.2. For a major conversion involving the replacement of a marine diesel engine with a non-identical marine diesel engine or the installation of an additional marine diesel engine, the standards in this regulation in force at the time of the replacement or addition of the engine shall apply. On or after 1 January 2016, in the case of replacement engines only, if it is not possible for such a replacement engine to meet the standards set forth in paragraph 5.1.1 of this regulation (Tier III), then that replacement engine shall meet the standards set forth in paragraph 4 of this regulation (Tier II). Guidelines are to be developed by the Organization to set forth the criteria of when it is not possible for a replacement engine to meet the standards in subparagraph 5.1.1 of this regulation.
- 2.3. A marine diesel engine referred to in paragraph 2.1.2 or 2.1.3 shall meet the following standards:
 - 2.3.1. for ships constructed prior to 1 January 2000, the standards set forth in paragraph 3 of this regulation shall apply; and
 - 2.3.2. for ships constructed on or after 1 January 2000, the standards in force at the time the ship was constructed shall apply.

Tier I

3. Subject to regulation 3 of this Chapter, the operation of a marine diesel engine which is installed on a ship constructed on or after 1 January 2000 and prior to 1 January 2011 is prohibited, except when the emission of nitrogen oxides (calculated as the total weighted emission of NO₂) from the engine is within the following limits, where n = rated engine speed (crankshaft revolutions per minute):
 - 3.1. 17.0 g/kWh when n is less than 130 rpm;
 - 3.2. $45.0 \times n^{(-0.2)}$ g/kWh when n is 130 or more but less than 2000 rpm;
 - 3.3. 9.8 g/kWh when n is 2000 rpm or more.

Tier II

4. Subject to regulation 3 of this Chapter, the operation of a marine diesel engine which is installed on a ship constructed on or after 1 January 2011 is prohibited, except when the emission of nitrogen oxides (calculated as the total weighted emission of NO₂) from the engine is within the following limits, where n = rated engine speed (crankshaft revolutions per minute):
 - 4.1. 14.4 g/kWh when n is less than 130 rpm;
 - 4.2. $44 \times n^{(-0.23)}$ g/kWh when n is 130 or more but less than 2000 rpm;
 - 4.3. 7.7 g/kWh when n is 2000 rpm or more.

Tier III

5.
 - 5.1. Subject to regulation 3 of this Chapter, the operation of a marine diesel engine which is installed on a ship constructed on or after 1 January 2016:
 - 5.1.1. is prohibited, except when the emission of nitrogen oxides (calculated as the total weighted emission of NO₂) from the engine is within the following limits, where n = rated engine speed (crankshaft revolutions per minute):
 - 5.1.1.1. 3.4 g/kWh when n is less than 130 rpm;
 - 5.1.1.2. $9 \times n^{(-0.2)}$ g/kWh when n is 130 or more but less than 2000 rpm;
 - 5.1.1.3. 2.0 g/kWh when n is 2000 rpm or more.
 - 5.1.2. is subject to the standards set forth in subparagraph 5.1.1 of this paragraph when the ship is operating in an Emission Control Area designated under paragraph 6 of this regulation; and
 - 5.1.3. is subject to the standards set forth in paragraph 4 of this regulation when the ship is operating outside of an Emission Control Area designated under paragraph 6 of this regulation.
 - 5.2. Subject to the review set forth in paragraph 10 of this regulation, the standards set forth in paragraph 5.1.1 of this regulation shall not apply to:
 - 5.2.1. a marine diesel engine installed on a ship with a length (L), as defined in regulation 1.19 of Annex I to the MARPOL Convention, less than 24 metres when it has been specifically designed, and is used solely, for recreational purposes; or
 - 5.2.2. a marine diesel engine installed on a ship with a combined nameplate diesel engine propulsion power of less than 750 kW if it is demonstrated, to the satisfaction of the Administration, that the ship cannot comply with the standards set forth in paragraph 5.1.1 of this regulation because of design or construction limitations of the ship.

Emission Control Area

6. For the purpose of this regulation, an Emission Control Area shall be any sea area, including any port area, designated by the Organization in accordance with the criteria and procedures set forth in appendix III to this chapter.

Marine diesel engines installed on a ship constructed prior to 1 January 2000

7.
 - 7.1. Notwithstanding paragraph 1.1.1 of this regulation, a marine diesel engine with a power output of more than 5,000 kW and a per cylinder displacement at or above 90 litres installed on a ship constructed on or after 1 January 1990 but prior to 1 January 2000 shall comply with the emission limits set forth in subparagraph 7.4 of this paragraph, provided that an Approved Method for that engine has been certified by an Administration of a Party and notification of such certification has been submitted to the Organization by the certifying Administration. Compliance with this paragraph shall be demonstrated through one of the following:
 - 7.1.1. installation of the certified Approved Method, as confirmed by a survey using the verification procedure specified in the Approved Method File, including appropriate notation on the ship's International Air Pollution Prevention Certificate of the presence of the Approved Method; or
 - 7.1.2. certification of the engine confirming that it operates within the limits set forth in paragraph 3, 4, or 5.1.1 of this regulation and an appropriate notation on the engine certification on the ship's International Air Pollution Prevention Certificate.
 - 7.2. Subparagraph 7.1 shall apply no later than the first renewal survey that occurs 12 months or more after deposit of the notification in subparagraph 7.1. If a shipowner of a ship on which an Approved Method is to be installed can demonstrate to the satisfaction of the Administration that the Approved Method was not commercially available despite best efforts to obtain it, then that Approved Method shall be installed on the ship no later than the next annual survey of that ship which falls after the Approved Method is commercially available.
 - 7.3. With regard to a ship with a marine diesel engine with a power output of more than 5,000 kW and a per cylinder displacement at or above 90 litres installed on a ship constructed on or after 1 January 1990 but prior to 1 January 2000, the International Air Pollution Prevention Certificate shall, for a marine diesel engine to which paragraph 7.1 of this regulation applies, indicate that either an Approved Method has been applied pursuant to paragraph 7.1.1 of this regulation or the engine has been certified pursuant to paragraph 7.1.2 of this regulation or that an Approved Method does not yet exist or is not yet commercially available as described in subparagraph 7.2 of this regulation.
 - 7.4. Subject to regulation 3 of this chapter, the operation of a marine diesel engine described in subparagraph 7.1 is prohibited, except when the emission of nitrogen oxides (calculated as the total weighted emission of NO₂) from the engine is within the following limits, where n = rated engine speed (crankshaft revolutions per minute):
 - 7.4.1. 17.0 g/kWh when n is less than 130 rpm;
 - 7.4.2. $45 \times n^{(-0.2)}$ g/kWh when n is 130 or more but less than 2000 rpm;
 - 7.4.3. 9.8 g/kWh when n is 2000 rpm or more.
 - 7.5. Certification of an Approved Method shall be in accordance with chapter 7 of the revised NO_x Technical Code 2008 and shall include verification:

- 7.5.1. by the designer of the base marine diesel engine to which the Approved Method applies that the calculated effect of the Approved Method will not decrease engine rating by more than 1.0%, increase fuel consumption by more than 2.0% as measured according to the appropriate test cycle set forth in the revised NO_x Technical Code 2008, or adversely affect engine durability or reliability; and
- 7.5.2. that the cost of the Approved Method is not excessive, which is determined by a comparison of the amount of NO_x reduced by the Approved Method to achieve the standard set forth in subparagraph 7.4 of this paragraph and the cost of purchasing and installing such Approved Method.²

Certification

8. The revised NO_x Technical Code 2008 shall be applied in the certification, testing and measurement procedures for the standards set forth in this regulation.
9. The procedures for determining NO_x emissions set out in the revised NO_x Technical Code 2008 are intended to be representative of the normal operation of the engine. Defeat devices and irrational emission control strategies undermine this intention and shall not be allowed. This regulation shall not prevent the use of auxiliary control devices that are used to protect the engine and/or its ancillary equipment against operating conditions that could result in damage or failure or that are used to facilitate the starting of the engine.

Review

10. Beginning in 2012 and completed no later than 2013, the Organization shall review the status of the technological developments to implement the standards set forth in paragraph 5.1.1 of this regulation and shall, if proven necessary, adjust the time periods set forth in that subparagraph.

S/M Regulation 14 – Sulphur oxides (SO_x) and particulate matter

Attention is drawn to the fact that the following regulation is only the Danish Maritime Authority's translation of MARPOL. As regards Danish legislation, reference is made to the Danish Ministry of the Environment.

General requirements

1. (M) The sulphur content of any fuel oil used on board ships shall not exceed the following limits:
 - 1.1. 4.5% m/m prior to 1 January 2012;
 - 1.2. 3.50% m/m on and after 1 January 2012; and
 - 1.3. 0.50% m/m on and after 1 January 2020.
2. (M) The world-wide average sulphur content of residual fuel oil supplied for use on board ships shall be monitored taking into account guidelines to be developed by the Organization.³

² The cost of an Approved Method shall not exceed 375 Special Drawing Rights/metric ton NO_x calculated in accordance with the Cost-Effectiveness formula below:

$$Ce = \frac{\text{Cost of Approved Method} \times 10^6}{P(\text{kW}) \times 0.768 \times 6000(\text{hours/year}) \times 5 (\text{years}) \times \Delta \text{NO}_x (g / kWh)}$$

³ Refer to resolution MEPC.82(43), Guidelines for monitoring the world-wide average sulphur content of residual fuel oils supplied for use on board ships.

Requirements within emission control areas

3. (M) For the purpose of this regulation, emission control areas shall include:
 - 3.1. the Baltic Sea area as defined in regulation 1.11.2 of Chapter XXI, the North Sea area as defined in regulation 5(1)(f) of Chapter XXV; and
 - 3.2. any other sea area, including port areas, designated by the Organization in accordance with criteria and procedures set forth in appendix III to this Chapter.
4. (M) While ships are operating within an emission control area, the sulphur content of fuel oil used on board ships shall not exceed the following limits:
 - 4.1. (M) 1.5% m/m prior to 1 July 2010;
 - 4.2. (M) 1.00% m/m on and after 1 July 2010; and
 - 4.3. (M) 0.10% m/m on and after 1 January 2015.
5. (M) The sulphur content of fuel oil referred to in paragraph 1 and paragraph 4 of this regulation shall be documented by its suppliers as required by regulation 18 of this Chapter.
6. (M) Those ships using separate fuel oils to comply with paragraph 4 of this regulation and entering or leaving an Emission Control Area set forth in paragraph 3 of this regulation shall carry a written procedure showing how the fuel oil change-over is to be done, allowing sufficient time for the fuel oil service system to be fully flushed of all fuel oils exceeding the applicable sulphur specified in paragraph 4 of this regulation prior to entry into an emission control area. The volume of low-sulphur fuel oils in each tank as well as the date, time, and position of the ship when any fuel-oil-change-over operation is completed, shall be recorded in such log-book as prescribed by the Administration.
7. (M) During the first 12 months immediately following an amendment designating a specific emission control area under paragraph 3.2 of this regulation, ships operating in that emission control area are exempt from the requirements in paragraphs 4 and 6 of this regulation and from the requirements of paragraph 5 of this regulation insofar as they relate to paragraph 4 of this regulation.

Review provision

8. A review of the standard set forth in subparagraph 1.3 of this regulation shall be completed by 2018 to determine the availability of fuel oil to comply with the fuel oil standard set forth in that paragraph and shall take into account the following elements:
 - 8.1. the global market supply and demand for fuel oil to comply with paragraph 1.3 of this regulation that exist at the time that the review is conducted;
 - 8.2. an analysis of the trends in fuel oil markets; and
 - 8.3. any other relevant issue.
9. The Organization shall establish a group of experts, comprising of representatives with the appropriate expertise in the fuel oil market and appropriate maritime, environmental, scientific, and legal expertise, to conduct the review referred to in paragraph 8 of this regulation. The group of experts shall develop the appropriate information to inform the decision to be taken by the Parties.
10. The Parties, based on the information developed by the group of experts, may decide whether it is possible for ships to comply with the date in paragraph 1.3 of this regulation. If a decision is taken that it is not possible for ships to comply, then the standard in that subparagraph shall become effective on 1 January 2025.

M Regulation 15 – Volatile organic compounds

Attention is drawn to the fact that the following regulation is only the Danish Maritime Authority's translation of MARPOL. As regards Danish legislation in force, reference is made to the Danish Ministry of the Environment.

1. If the emissions of volatile organic compounds (VOCs) from a tanker are to be regulated in a port or ports or a terminal or terminals under the jurisdiction of a Party, they shall be regulated in accordance with the provisions of this regulation.
2. A Party regulating tankers for VOC emissions shall submit a notification to the Organization. This notification shall include information on the size of tankers to be controlled, the cargoes requiring vapour emission control systems, and the effective date of such control. The notification shall be submitted at least six months before the effective date.
3. A Party which designates ports or terminals at which VOC emissions from tankers are to be regulated shall ensure that vapour emission control systems, approved by that Party taking into account the safety standards for such systems developed by the Organization,⁴ are provided in any designated port and terminal and are operated safely and in a manner so as to avoid undue delay to a ship.
4. The Organization shall circulate a list of the ports and terminals designated by the Parties to other Parties and Member States of the Organization for their information.
5. A tanker to which paragraph 1 of this regulation applies shall be provided with a vapour emission collection system approved by the Administration taking into account the safety standards for such systems developed by the Organization⁵, and shall use this system during the loading of relevant cargoes. A port or terminal which has installed vapour emission control systems in accordance with this regulation may accept tankers which are not fitted with vapour collection systems for a period of three years after the effective date identified in paragraph 2 of this regulation.
6. A tanker carrying crude oil shall have on board and implement a VOC Management Plan approved by the Administration. Such a plan shall be prepared taking into account the guidelines developed by the Organization. The plan shall be specific to each ship and shall at least:
 - 6.1. provide written procedures for minimizing VOC emissions during the loading, sea passage and discharge of cargo;
 - 6.2. give consideration to the additional VOC generated by crude oil washing;
 - 6.3. identify a person responsible for implementing the plan; and
 - 6.4. for ships on international voyages, be written in the working language of the master and officers, and, if the working language of the master and officers is not English, French, or Spanish, include a translation into one of these languages.
7. This regulation shall apply to gas carriers only if the type of loading and containment systems allow safe retention of non-methane VOCs on board or their safe return ashore.⁶

⁴ Refer to resolution MEPC.130(53), "Guidelines for on-board exhaust gas SO_x cleaning systems."

⁵ Refer to MSC/Circ.585, "Standards for vapour emission control systems".

⁶ Refer to resolution MSC.30(61), International Code for the Construction and Equipment of Ships Carrying Liquefied Gases in Bulk, chapter 5.

S/M Regulation 16 – Shipboard incineration

Attention is drawn to the fact that the following regulation is only the Danish Maritime Authority's translation of MARPOL. As regards Danish legislation in force, reference is made to the Danish Ministry of the Environment.

1. (M) Except as provided in paragraph 4 of this regulation, shipboard incineration shall be allowed only in a shipboard incinerator.
2. (M) Shipboard incineration of the following substances shall be prohibited:
 - 2.1. residues of cargoes subject to Annex I, II or III of the MARPOL Convention or related contaminated packing materials;
 - 2.2. polychlorinated biphenyls (PCBs);
 - 2.3. garbage, as defined by Annex V of the MARPOL Convention, containing more than traces of heavy metals;
 - 2.4. refined petroleum products containing halogen compounds;
 - 2.5. sewage sludge and sludge oil either of which are not generated on board the ship; and
 - 2.6. exhaust gas cleaning system residues.
3. (M) Shipboard incineration of polyvinyl chlorides (PVCs) shall be prohibited, except in shipboard incinerator for which an IMO Type Approval Certificate⁷ has been issued.
4. (M) Shipboard incineration of sewage sludge and sludge oil generated during normal operation of a ship may also take place in the main or auxiliary power plant or boilers, but in those cases, shall not take place inside ports, harbours and estuaries.
5.
 - 5.1. (M) Nothing in this regulation affects the prohibition in, or other requirements of, the Convention on the Prevention of Marine Pollution by Dumping of Wastes and Other Matter, 1972, as amended, and the 1996 Protocol thereto.
 - 5.2. (S) Nothing in this regulation precludes the development, installation and operation of alternative design shipboard thermal waste treatment devices that meet or exceed the requirements of this regulation.
6. (S)
 - 6.1. Except as provided in subparagraph 6.2 of this paragraph, each incinerator on a ship constructed on or after 1 January 2000 or incinerator which is installed on board a ship on or after 1 January 2000 shall meet the requirements contained in appendix IV to this Chapter. Each incinerator subject to this subparagraph shall be approved by the Administration taking into account the standard specifications for shipboard incinerators developed by the Organization;⁸ or
 - 6.2. The Administration may allow exclusion from the application of subparagraph 6.1 of this paragraph to any incinerator which is installed on board a ship before 19 May 2005, provided that the ship is solely engaged in voyages within waters subject to the sovereignty or jurisdiction of the State the flag of which the ship is entitled to fly.
7. (S) Incinerators installed in accordance with the requirements of paragraph 6.1 of this regulation shall be provided with a manufacturer's operating manual which is to be retained with the unit and

⁷ Type Approval Certificates issued in accordance with resolution MEPC.59(33) or MEPC.76(40).

⁸ Refer to resolution MEPC.76(40), Standard specification for shipboard incinerators.

which shall specify how to operate the incinerator within the limits described in paragraph 2 of appendix IV of this Chapter.

8. (S) Personnel responsible for the operation of an incinerator installed in accordance with the requirements of paragraph 6.1 of this regulation shall be trained to implement the guidance provided in the manufacturer's operating manual as required by paragraph 7 of this regulation.
9. (S) For incinerators installed in accordance with the requirements of paragraph 6.1 of this regulation the combustion chamber gas outlet temperature shall be monitored at all times the unit is in operation. Where that incinerator is of the continuous-feed type, waste shall not be fed into the unit when the combustion chamber gas outlet temperature is below 850°C. Where that incinerator is of the batch-loaded type, the unit shall be designed so that the combustion chamber gas outlet temperature shall reach 600°C within five minutes after start-up and will thereafter stabilize at a temperature not less than 850°C.

(M) Regulation 17 – Reception facilities

Attention is drawn to the fact that the following regulation is only the Danish Maritime Authority's translation of MARPOL. As regards Danish legislation in force, reference is made to the Danish Ministry of the Environment.

1. Each Party undertakes to ensure the provision of facilities adequate to meet the:
 - 1.1. needs of ships using its repair ports for the reception of ozone-depleting substances and equipment containing such substances when removed from ships;
 - 1.2. needs of ships using its ports, terminals or repair ports for the reception of exhaust gas cleaning residues from an approved exhaust gas cleaning system,
without causing undue delay to ships, and
 - 1.3. needs in ship breaking facilities for the reception of ozone depleting substances and equipment containing such substances when removed from ships.
2. If a particular port or terminal of a Party is – taking into account the guidelines to be developed by the Organization – remotely located from, or lacking in, the industrial infrastructure necessary to manage and process those substances referred to in paragraph 1 of this regulation and therefore cannot accept such substances, then the Party shall inform the Organization of any such port or terminal so that this information may be circulated to all Parties and Member States of the Organization for their information and any appropriate action. Each Party that has provided the Organization with such information shall also notify the Organization of its ports and terminals where reception facilities are available to manage and process such substances.
3. Each Party shall notify the Organization for transmission to the Members of the Organization of all cases where the facilities provided under this regulation are unavailable or alleged to be inadequate.

S/M Regulation 18 – Fuel oil availability and quality

Attention is drawn to the fact that the following regulation is only the Danish Maritime Authority's translation of MARPOL. As regards Danish legislation in force, reference is made to the Danish Ministry of the Environment.

Fuel oil availability

1. Each Party shall take all reasonable steps to promote the availability of fuel oils which comply with this chapter and inform the Organization of the availability of compliant fuel oils in its ports and terminals.
2.
 - 2.1. If a ship is found by a Party not to be in compliance with the standards for compliant fuel oils set forth in this chapter, the competent authority of the Party is entitled to require the ship to:
 - 2.1.1. present a record of the actions taken to attempt to achieve compliance; and
 - 2.1.2. provide evidence that it attempted to purchase compliant fuel oil in accordance with its voyage plan and, if it was not made available where planned, that attempts were made to locate alternative sources for such fuel oil and that despite best efforts to obtain compliant fuel oil, no such fuel oil was made available for purchase.
 - 2.2. The ship should not be required to deviate from its intended voyage or to delay unduly the voyage in order to achieve compliance.
 - 2.3. If a ship provides the information set forth in subparagraph 2.1 of this paragraph, a Party shall take into account all relevant circumstances and the evidence presented to determine the appropriate action to take, including not taking control measures.
 - 2.4. A ship shall notify its Administration and the competent authority of the relevant port of destination when it cannot purchase compliant fuel oil.
 - 2.5. A Party shall notify the Organization when a ship has presented evidence of the non-availability of compliant fuel oil.

Fuel oil quality

3. (M) Fuel oil for combustion purposes delivered to and used on board ships to which this Chapter applies shall meet the following requirements:
 - 3.1. except as provided in sub-paragraph 3.2:
 - 3.1.1. the fuel oil shall be blends of hydrocarbons derived from petroleum refining. This shall not preclude the incorporation of small amounts of additives intended to improve some aspects of performance;
 - 3.1.2. the fuel oil shall be free from inorganic acid; and
 - 3.1.3. the fuel oil shall not include any added substance or chemical waste which:
 - 3.1.3.1. jeopardizes the safety of ships or adversely affects the performance of the machinery, or
 - 3.1.3.2. is harmful to personnel, or
 - 3.1.3.3. contributes overall to additional air pollution.
 - 3.2. fuel oil for combustion purposes derived by methods other than petroleum refining shall not:
 - 3.2.1. exceed the sulphur content set forth in regulation 14 of this Chapter;
 - 3.2.2. cause an engine to exceed the applicable NO_x emission limit set forth in paragraphs 3, 4, 5.11 and 7.4 of regulation 13;
 - 3.2.3. contain inorganic acid; or
 - 3.2.4.
 - 3.2.4.1. jeopardize the safety of ships or adversely affect the performance of the machinery, or
 - 3.2.4.2. be harmful to personnel, or
 - 3.2.4.3. contribute overall to additional air pollution.

4. (M) This regulation does not apply to coal in its solid form or nuclear fuels. Paragraphs 5, 6, 7.1, 7.2, 8.1, 8.2, 9.2, 9.3 and 9.4 of this regulation do not apply to gas fuels such as Liquefied Natural Gas, Compressed Natural Gas or Liquefied Petroleum Gas. The sulphur content of gas fuels delivered to a ship specifically for combustion purposes on board that ship shall be documented by the supplier.
5. (M) For each ship subject to regulations 5 and 6 of this Chapter, details of fuel oil for combustion purposes delivered to and used on board shall be recorded by means of a bunker delivery note which shall contain at least the information specified in appendix V to this Chapter.
6. (S) The bunker delivery note shall be kept on board the ship in such a place as to be readily available for inspection at all reasonable times. It shall be retained for a period of three years after the fuel oil has been delivered on board.
7. (S)
 - 7.1. The competent authority of a Party may inspect the bunker delivery notes on board any ship to which this Chapter applies while the ship is in its port or offshore terminal, may make a copy of each delivery note, and may require the master or person in charge of the ship to certify that each copy is a true copy of such bunker delivery note. The competent authority may also verify the contents of each note through consultations with the port where the note was issued.
 - 7.2. The inspection of the bunker delivery notes and the taking of certified copies by the competent authority under this paragraph shall be performed as expeditiously as possible without causing the ship to be unduly delayed.
8.
 - 8.1. (M) The bunker delivery note shall be accompanied by a representative sample of the fuel oil delivered taking into account guidelines to be developed by the Organization⁹. The sample is to be sealed and signed by the supplier's representative and the master or officer in charge of the bunker operation on completion of bunkering operations and retained under the ship's control until the fuel oil is substantially consumed, but in any case for a period of not less than 12 months from the time of delivery.
 - 8.2. If an Administration requires the representative sample to be analysed, it shall be done in accordance with the verification procedure set forth in appendix VI to determine whether the fuel oil meets the requirements of this chapter.
9. (M) Parties undertake to ensure that appropriate authorities designated by them:
 - 9.1. maintain a register of local suppliers of fuel oil;
 - 9.2. require local suppliers to provide the bunker delivery note and sample as required by this regulation, certified by the fuel oil supplier that the fuel oil meets the requirements of regulations 14 and 18 of this Chapter;
 - 9.3. require local suppliers to retain a copy of the bunker delivery note for at least three years for inspection and verification by the port State as necessary;
 - 9.4. take action as appropriate against fuel oil suppliers that have been found to deliver fuel oil that does not comply with that stated on the bunker delivery note;
 - 9.5. inform the Administration of any ship receiving fuel oil found to be non-compliant with the requirements of regulations 14 or 18 of this Chapter; and

⁹ Refer to MEPC.96(47), "Guidelines for the sampling of fuel oil for determination of compliance with Annex VI of MARPOL 73/78".

- 9.6. inform the Organization for transmission to Parties and Member States of the Organization of all cases where fuel oil suppliers have failed to meet the requirements specified in regulations 14 or 18 of this Chapter.
10. (M) In connection with port State inspections carried out by Parties, the Parties further undertake to:
 - 10.1. inform the Party or non-Party under whose jurisdiction a bunker delivery note was issued of cases of delivery of noncompliant fuel oil, giving all relevant information; and
 - 10.2. ensure that remedial action as appropriate is taken to bring noncompliant fuel oil discovered into compliance.
11. For every ship of 400 gross tonnage and above on scheduled services with frequent and regular port calls, an Administration may decide after application and consultation with affected States that compliance with paragraph 6 of this regulation may be documented in an alternative manner which gives similar certainty of compliance with regulations 14 and 18 of this chapter.

Appendix 1

Form of International Air Pollution Prevention (IAPP) Certificate (regulation 8)

Reference is made to Annex 1C of Notice B.

Appendix II

Test cycles and weighting factors (regulation 13)

The following test cycles and weighting factors should be applied for verification of compliance of marine diesel engines with the applicable NO_x limit in accordance with regulation 13 of this Chapter using the test procedure and calculation method as specified in the revised NO_x Technical Code 2008.

1. For constant-speed marine engines for ship main propulsion, including diesel-electric drive, test cycle E2 shall be applied;
2. For controllable-pitch propeller sets test cycle E2 shall be applied.
3. For propeller-law-operated main and propeller-law-operated auxiliary engines the test cycle E3 shall be applied.
4. For constant-speed auxiliary engines test cycle D2 shall be applied.
5. For variable-speed, variable-load auxiliary engines, not included above, test cycle C1 shall be applied.

Test cycle for “constant-speed main propulsion application” (including diesel-electric drive or variable-pitch propeller installations)

Test cycle type E2	Speed	100%	100%	100%	100%
	Power	100%	75%	50%	25%
	Weighting factor	0.2	0.5	0.15	0.15

Test cycle for “propeller-law-operated main and propeller-law-operated auxiliary engine” application

Test cycle type E3	Speed	100%	91%	80%	63%
	Power	100%	75%	50%	25%
	Weighting factor	0.2	0.5	0.15	0.15

Test cycle for “constant-speed auxiliary engine” application

Test cycle type D2	Speed	100%	100%	100%	100%	100%
	Power	100%	75%	50%	25%	10%
	Weighting factor	0.05	0.25	0.3	0.3	0.1

Test cycle for “variable-speed and load auxiliary engine” application

Test cycle type C1	Speed	Rated				Intermediate			Idle
	Torque	100%	75%	50%	10%	100%	75%	50%	0%
Weighting factor	0.15	0.15%	0.15%	0.1	0.1	0.1	0.1	0.15	

Appendix III

Criteria and procedures for designation of emission control areas

(regulation 13.6 and regulation 14.3)

1. Objectives

- 1.1. The purpose of this appendix is to provide the criteria and procedures to Parties for the formulation and submission of proposals for the designation of Emission Control Areas and to set forth the factors to be considered in the assessment of such proposals by the Organization.
- 1.2. Emissions of NO_x, SO_x and particulate matter from ocean-going ships contribute to ambient concentrations of air pollution in cities and coastal areas around the world. Adverse public health and environmental effects associated with air pollution include premature mortality, cardiopulmonary disease, lung cancer, chronic respiratory ailments, acidification and eutrophication.
- 1.3. An Emission Control Area should be considered for adoption by the Organization if supported by a demonstrated need to prevent, reduce, and control emissions of NO_x or SO_x and particulate matter or all three types of emissions (hereinafter emissions) from ships.

2. Process for the designation of emission control areas

- 2.1. A proposal to the Organization for designation of an Emission Control Area for NO_x or SO_x and particulate matter or all three types of emissions may be submitted only by Parties. Where two or more Parties have a common interest in a particular area, they should formulate a coordinated proposal.
- 2.2. A proposal to designate a given area as an Emission Control Area should be submitted to the Organization in accordance with the rules and procedures established by the Organization.

3. Criteria for designation of an Emission Control Area

- 3.1. The proposal shall include:
 - 3.1.1. a clear delineation of the proposed area of application, along with a reference chart on which the area is marked;
 - 3.1.2. the type or types of emission(s) that is or are being proposed for control (i.e. NO_x or SO_x and particulate matter or all three types of emissions);
 - 3.1.3. a description of the human populations and environmental areas at risk from the impacts of ship emissions;
 - 3.1.4. an assessment that emissions from ships operating in the proposed area of application are contributing to ambient concentrations of air pollution or to adverse environmental impacts. Such assessments shall include a description of the impacts of the relevant emissions on human health and the environment, such as adverse impacts to terrestrial and aquatic ecosystems, areas of natural productivity, critical habitats, water quality, human health, and areas of cultural and scientific significance, if applicable. The sources of relevant data including methodologies used shall be identified;
 - 3.1.5. relevant information pertaining to the meteorological conditions in the proposed area of application to the human populations and environmental areas at risk, in particular prevailing wind patterns, or to topographical, geological, oceanographic,

- morphological, or other conditions that contribute to ambient concentrations of air pollution or adverse environmental impacts;
- 3.1.6. the nature of the ship traffic in the proposed Emission Control Area, including the patterns and density of such traffic;
 - 3.1.7. a description of the control measures taken by the proposing Party or Parties addressing land-based sources of NO_x, SO_x and particulate matter emissions affecting the human populations and environmental areas at risk that are in place and operating concurrent with the consideration of measures to be adopted in relation to provisions of regulations 13 and 14 of chapter XXVI; and
 - 3.1.8. the relative costs of reducing emissions from ships when compared with land-based controls, and the economic impacts on shipping engaged in international trade.
- 3.2. The geographical limits of an Emission Control Area will be based on the relevant criteria, outlined above, including emissions and deposition from ships navigating in the proposed area, traffic patterns and density, and wind conditions.
4. **Procedures for the assessment and adoption of Emission Control Areas by the Organization**
- 4.1. The Organization shall consider each proposal submitted to it by a Party or Parties.
 - 4.2. In assessing the proposal, the Organization shall take into account the criteria which are to be included in each proposal for adoption as set forth in section 3 above.
 - 4.3. An Emission Control Area shall be designated by means of an amendment to this chapter, considered, adopted and brought into force in accordance with article 16 of the MARPOL Convention.
5. **Operation of Emission Control Areas**
- 5.1. Parties which have ships navigating in the area are encouraged to bring to the Organization any concerns regarding the operation of the area.

Appendix IV

Type approval and operating limits for shipboard incinerators (regulation 16)

1. Ships incinerators described in regulation 16.6.1 on board shall possess an IMO type approval certificate for each incinerator. In order to obtain such certificate, the incinerator shall be designed and built to an approved standard as described in regulation 16.6.1. Each model shall be subject to a specified type approval test operation at the factory or an approved test facility, and under the responsibility of the Administration, using the following standard fuel/waste specification for the type approval test for determining whether the incinerator operates within the limits specified in paragraph 2 of this appendix:

Sludge oil consisting of: 75% sludge oil from HFO;
 5% waste lubricating oil;
 and
 20% emulsified water

Solid waste consisting of: 50% food waste
 50% rubbish containing
 approx. 30% paper,
 approx. 40% card-board,
 approx. 10% rags,
 approx. 20% plastic
 The mixture will have up to 50% moisture and 7%
 incombustible solids.

2. Incinerators described in regulation 16.6.1 shall operate within the following limits:

O₂ in combustion chamber: 6-12%

CO in flue gas maximum 200 mg/MJ

average:

Soot number maximum or Bacharach 3 or Ringelman 1

average: (20% opacity)

(A higher soot number is acceptable only during very short periods
such as starting up)

Unburned components in ash Maximum 10% by weight
residues:

Combustion chamber flue gas 850-1200°C

outlet temperature range:

Appendix V

Information to be included in the bunker delivery note (regulation 18(5))

Name and IMO number of receiving ship

Port

Date of commencement of delivery

Name, address, and telephone number of marine fuel oil supplier

Product name(s)

Quantity (metric tons)

Density ¹⁰ at 15°C (kg/m³)

Sulphur content¹¹⁾ (% m/m)

A declaration signed and certified by the fuel oil supplier's representative that the fuel oil supplied is in conformity with the applicable subparagraph of regulation 14.1 or 14.4 and regulation 18.3 of this chapter.

¹⁰ Fuel oil shall be tested in accordance with ISO 3675:1998 or ISO 12185:1996.

¹¹⁾ Fuel oil shall be tested in accordance with ISO 8754:2003.

Appendix VI

Fuel verification procedure for MARPOL Annex VI. Fuel oil samples

(regulation 18.8.2)

The following procedure shall be used to determine whether the fuel oil delivered to and used on board ships is compliant with the sulphur limits required by regulation 14 of chapter XXVI.

1. General requirements

- 1.1. The representative fuel oil sample, which is required by paragraph 8.1 of regulation 18 (the "MARPOL sample") shall be used to verify the sulphur content of the fuel oil supplied to a ship.
- 1.2. An Administration, through its competent authority, shall manage the verification procedure.
- 1.3. The laboratories responsible for the verification procedure set forth in this appendix shall be fully accredited for the purpose of conducting the tests.

2. Verification procedure stage 1

- 2.1. The MARPOL sample shall be delivered by the competent authority to the laboratory.
- 2.2. The laboratory shall:
 - 2.2.1. record the details of the seal number and the sample label on the test record;
 - 2.2.2. confirm that the condition of the seal on the MARPOL sample has not been broken; and
 - 2.2.3. reject any MARPOL sample where the seal has been broken.
- 2.3. If the seal of the MARPOL sample has not been broken, the laboratory shall proceed with the verification procedure and shall:
 - 2.3.1. ensure that the MARPOL sample is thoroughly homogenized;
 - 2.3.2. draw two sub-samples from the MARPOL sample; and
 - 2.3.3. reseal the MARPOL sample and record the new reseal details on the test record.
- 2.4. The two sub-samples shall be tested in succession, in accordance with the specified test method referred to in appendix V. For the purposes of this verification procedure, the results of the test analysis shall be referred to as "A" and "B":
 - 2.4.1. If the results of "A" and "B" are within the repeatability (r) of the test method, the results shall be considered valid.
 - 2.4.2. If the results of "A" and "B" are not within the repeatability (r) of the test method, both results shall be rejected and two new sub-samples should be taken by the laboratory and analysed. The sample bottle should be resealed in accordance with paragraph 2.3.3 above after the new sub-samples have been taken.
- 2.5. If the test results of "A" and "B" are valid, an average of these two results should be calculated thus giving the result referred to as "X":
 - 2.5.1. If the result of "X" is equal to or falls below the applicable limit required by chapter XXVI, the fuel oil shall be deemed to meet the requirements.
 - 2.5.2. If the result of "X" is greater than the applicable limit required by chapter XXVI, Verification Procedure Stage 2 should be conducted; however, if the result of "X" is greater than the specification limit by 0.59R (where R is the reproducibility of the test

method), the fuel oil shall be considered non-compliant and no further testing is necessary.

3. Verification Procedure Stage 2

- 3.1. If Stage 2 of the verification procedure is necessary in accordance with paragraph 2.5.2 above, the competent authority shall send the MARPOL sample to a second accredited laboratory.
- 3.2. Upon receiving the MARPOL sample, the laboratory shall:
 - 3.2.1. record the details of the reseal number applied in accordance with 2.3.3 and the sample label on the test record;
 - 3.2.2. draw two sub-samples from the MARPOL sample; and
 - 3.2.3. reseal the MARPOL sample and record the new reseal details on the test record.
- 3.3. The two sub-samples shall be tested in succession, in accordance with the test method specified in appendix V. For the purposes of this verification procedure, the results of the test analysis shall be referred to as “C” and “D”:
 - 3.3.1. If the results of “C” and “D” are within the repeatability (r) of the test method, the results shall be considered valid.
 - 3.3.2. If the results of “C” and “D” are not within the repeatability (r) of the test method, both results shall be rejected and two new sub-samples shall be taken by the laboratory and analysed. The sample bottle should be resealed in accordance with paragraph 3.2.3 after the new sub-samples have been taken.
- 3.4. If the test results of “C” and “D” are valid, and the results of “A”, “B”, “C” and “D” are within the reproducibility (R) of the test method then the laboratory shall average the results, which is referred to as “Y”:
 - 3.4.1. If the result of “Y” is equal to or falls below the applicable limit required by chapter XXVI, the fuel oil shall be deemed to meet the requirements.
 - 3.4.2. If the result of “Y” is greater than the applicable limit required by chapter XXVI, then the fuel oil fails to meet the standards required by chapter XXVI.
- 3.5. If the result of “A”, “B”, “C” and “D” are not within the reproducibility (R) of the test method then the Administration may discard all of the test results and, at its discretion, repeat the entire testing process.
- 3.6. The results obtained from the verification procedure are final.

**Notice from the Danish Maritime Authority B –
The Construction and Equipment, etc. of Ships**

Appendix B – Regulations that enter into force on 1 January 2011

Introduction

The provisions of this chapter enter into force on 1 January 2011.

The provisions will be incorporated into the relevant chapters with the spring 2011 publication.

Chapter II-1

Part A1 – Structure of ships

Regulation 3-5 – New installation and repairs of materials containing asbestos

The existing text of paragraph 2 is replaced by the following:

“2 From 1 January 2011, for all ships, new installation of materials which contain asbestos *as well as repairs carried out using materials containing asbestos* shall be prohibited.

Part C – Machinery installations

Regulation 3-5 – Bilge pumping arrangements

The following new paragraph 2.6.3 is added after the existing paragraph 2.6.2:

“2.6.3 Provisions for the drainage of closed vehicle and ro-ro spaces and special category spaces shall also comply with regulations II-2/20.6.1.4 and II-2/20.6.1.5.”

Chapter II-2 – Construction – Fire protection, fire detection and fire extinction

Part A – General

Regulation 1 – Application

The following new paragraph 2.4 is added after the existing paragraph 2.3:

“2.3 Ships constructed on or after 1 July 2002 and before 1 July 2010 shall comply with paragraphs 7.11, 7.4.42, 7.4.43 and 7.5.2.1.2 of regulation 9, as adopted by resolution MSC.99(73).

2.4 The following ships, with cargo spaces intended for the carriage of packaged dangerous goods, shall comply with regulation 19.3, except when carrying dangerous goods specified as classes 6.2 and 7 and dangerous goods in limited quantities¹ and

¹ Refer to chapter 3.4 of the IMDG Code.

excepted quantities² in accordance with tables 19.1 and 19.3, not later than the date of the first renewal survey on or after 1 January 2011:

2.4.1 cargo ships of 500 gross tonnage and upwards and passenger ships constructed on or after 1 September 1984 but before 1 January 2011; and

2.4.2 cargo ships of less than 500 gross tonnage constructed on or after 1 February 1992 but before 1 January 2011,

and not withstanding these provisions:

2.4.3 cargo ships of 500 gross tonnage and upwards and passenger ships constructed on or after 1 September 1984 but before 1 July 1986 need not comply with regulation 19.3.3 provided that they comply with regulation 54.2.3 as adopted by resolution MSC.1(XLV);

2.4.4 cargo ships of 500 gross tonnage and upwards and passenger ships constructed on or after 1 July 1986 but before 1 February 1992 need not comply with regulation 19.3.3 provided that they comply with regulation 54.2.3 as adopted by resolution MSC.6(48);

2.4.5 cargo ships of 500 gross tonnage and upwards and passenger ships constructed on or after 1 September 1984 but before 1 July 1998 need not comply with regulations 19.3.10.1 and 19.3.10.2; and

2.4.6 cargo ships of less than 500 gross tonnage constructed on or after 1 February 1992 but before 1 July 1998 need not comply with regulations 19.3.10.1 and 19.3.10.2.”

Part E – Operational requirements

Regulation 16 – Operations

In paragraph 2.1, the reference to the “Code of Safe Practice for Solid Bulk Cargoes” is replaced by the reference to “the International Maritime Solid Bulk Cargoes (IMSBC) Code”.

Part G – Special requirements

Regulation 19 – Carriage of dangerous goods

The existing note 1 to table 19.1 is replaced by the following:

“1 For classes 4 and 5.1 solids not applicable to closed freight containers. For classes 2, 3, 6.1 and 8 when carried in closed freight containers, the ventilation rate may be reduced to not less than two air changes per hours. For classes 4 and 5.1 liquids when carried in closed freight containers, the ventilation rate may be reduced to not less than two air changes per hour. For the purpose of this requirement, a portable tank is a closed freight container.”

In note 10 to table 19.2, the words “the Code of Safe Practice for Solid Bulk Cargoes, adopted by resolution A.434(XI)” are replaced by the words “the International Maritime Solid Bulk Cargoes (IMSBC) Code”.

² Refer to chapter 3.5 of the IMDG Code.

The existing table 19.3 is replaced by the following table:

Table 19.3 – Application of the requirements to different classes of dangerous goods except solid dangerous goods in bulk

Class →	1.1- 1.6	1.4S	2.1	2.2	2.3 flamm- able ²⁰	2.3 non- flamm- able	3 liquids ≤ 23°C ¹⁵	3 liquids >23°C ¹⁵ to ≤ 61°C	4.1	4.2	4.3 liquids ²¹	4.3 solids	5.1	5.2	6.1 liquids ≤ 23°C ¹⁵	6.1 liquids >23°C ¹⁵ to ≤ 61°C	6.1 liquids	6.1 solids	8 liquids ≤ 23°C ¹⁵	8 liquids 23°C ¹⁵ ≤ 61°C	8 liquids	8 solids	9
Regulation 19 ↓																							
.3.1.1	X	X	X	X	X	X	X	X	X	X	X	X	X	X	X	X	X	X	X	X	X	X	X
.3.1.2	X	X	X	X	X	X	X	X	X	X	X	X	X	X	X	X	X	X	X	X	X	X	-
.3.1.3	X	-	-	-	-	-	-	-	-	-	-	-	-	-	-	-	-	-	-	-	-	-	-
.3.1.4	X	-	-	-	-	-	-	-	-	-	-	-	-	-	-	-	-	-	-	-	-	-	-
.3.2	X	-	X	-	X	-	X	-	-	-	X ¹⁸	-	-	-	X	-	-	-	X	-	-	-	X ¹⁷
.3.3	X	X	X	X	-	X	X	X	X	X	X	X	X	-	X	X	X	X	X	X	X	X	-
.3.4.1	-	-	X	-	-	X	X	-	X ¹¹	X ¹¹	X	X	X ¹¹	-	X	X	-	X ¹¹	X	X	-	-	X ¹¹
.3.4.2	-	-	X	-	-	-	X	-	-	-	-	-	-	-	X	-	-	-	X	-	-	-	X ¹⁷
.3.5	-	-	-	-	-	-	X	-	-	-	-	-	-	-	X	X	X	-	X	X ¹⁹	X ¹⁹	-	-
.3.6	-	-	X	X	X	X	X	X	X	X	X	X	X	X	X	X	X	X	X	X	X	X	X ¹⁴
.3.7	-	-	-	-	-	-	X	X	X	X	X	X	X	-	X	X	-	-	X	X	-	-	-
.3.8	X ¹²	-	X	X	X	X	X	X	X	X	X	X	X ¹³	-	X	X	-	-	X	X	-	-	-
.3.9	X	X	X	X	X	X	X	X	X	X	X	X	X	X	X	X	X	X	X	X	X	X	X
.3.10.1	X	X	X	X	X	X	X	X	X	X	X	X	X	X ¹⁶	X	X	X	X	X	X	X	X	X
.3.10.2	X	X	X	X	X	X	X	X	X	X	X	X	X	X ¹⁶	X	X	X	X	X	X	X	X	X

Notes:

- 11 When "mechanically-ventilated spaces" are required by the IMDG Code.
- 12 Stow 3 m horizontally away from the machinery space boundaries in all cases.
- 13 Refer to the IMDG Code.
- 14 As appropriate to the goods to be carried.
- 15 FP means flashpoint.
- 16 Under the provisions of the IMDG Code, stowage of class 5.2 dangerous goods under deck or in enclosed ro-ro spaces is prohibited.
- 17 Only applicable to dangerous goods evolving flammable vapour listed in the IMDG Code.
- 18 Only applicable to dangerous goods having a flashpoint less than 23 C listed in the IMDG Code.
- 19 Only applicable to dangerous goods having a subsidiary risk class 6.1.
- 20 Under the provisions of the IMDG Code, stowage of class 2.3 having subsidiary risk class 2.1 under deck or in enclosed ro-ro spaces is prohibited.
- 21 Under the provisions of the IMDG Code, stowage of class 4.3 liquids having a flashpoint less than 23 C under deck or in enclosed ro-ro spaces is prohibited.

“19.3.6.1 Four sets of full protective clothing, resistant to chemical attack, shall be provided in addition to the fire-fighter's outfits required by regulation 10.10 and shall be selected taking into account the hazards associated with the chemicals being transported and the standards developed by the Organization according to the class and physical state.³ The protective clothing shall cover all skin, so that no part of the body is unprotected.”

In paragraph 2.1, after the words “except when carrying dangerous goods in limited quantities”, the following words are added:

“and excepted quantities.⁴”

Chapter V – Safety of navigation

Regulation 18 – Approval, surveys and performance standards of navigational systems and equipment, etc.

“18.4 Systems and equipment installed prior to the adoption of performance standards by the Organization may subsequently be exempted from full compliance with such standards at the discretion of the Administration, having due regard to the recommended criteria adopted by the Organization. However, for an electronic chart display and information system (ECDIS) to be accepted as satisfying the chart carriage requirement of regulation 19.1.2.4, that system shall conform to the relevant performance standards not inferior to those adopted by the Organization in effect on the date of installation, or, for systems installed before 1 January 1999, not inferior to the performance standards adopted by the Organization on 23 November 1995.⁵”

Regulation 19 – Carriage requirements for shipborne navigational systems and equipment

“19.1.2.4 *be fitted with a bridge navigation watch alarm system (BNWAS) in accordance with paragraphs 2.2.3 and 2.2.4.*

19.2.1.4 nautical charts and nautical publications to plan and display the ship's route for the intended voyage and to plot and monitor positions throughout the voyage. An electronic chart display and information system (ECDIS) is also accepted as meeting the chart carriage requirements of this subparagraph. Ships to which paragraph 2.10 applies shall comply with the carriage requirements for ECDIS detailed therein;”

The following new paragraph is added after the existing:

“19.2.2.3 *Ships with a wheelhouse shall be fitted with a bridge navigational watch alarm system (BNWAS), which shall be in operation whenever the ship is underway at sea.*

³ For solid bulk cargoes, the protective clothing should satisfy the equipment provisions specified in the respective schedules of the IMSBC Code for the individual substances. For packaged goods, the protective clothing should satisfy the equipment provisions specified in emergency procedures (EmS) of the Supplement to the IMDG Code for the individual substances.

⁴ Refer to chapter 3.5 of the IMDG Code.

⁵ Recommendation on Performance Standards for Electronic Chart Display and Information Systems (ECDIS) (resolution A.817(19)).

2.2.3.1 *The Convention requirement for a bridge navigational watch alarm system shall apply to cargo ships of 150 gross tonnage and upwards and passenger ships irrespective of size implemented from 1 July 2011 until 1 July 2014. Nationally, the equipment requirement has applied from 1 March 2006 to cargo ships with a length (L) of or above 15 metres, respectively⁶ of 100 and above as well as to passenger ships irrespective of size when engaged on international voyages.*

2.2.4 *The bridge navigational watch alarm system shall comply with the technical and operational requirements of the IMO functional standards⁷ for bridge navigational watch alarm systems (BNWAS)."*

“19.2.10 Ships engaged on international voyages shall be fitted with an Electronic Chart Display and Information System (ECDIS) as follows:

2.10.1 passenger ships of 500 gross tonnage and upwards constructed on or after 1 July 2012;

2.10.2 tankers of 3,000 gross tonnage and upwards constructed on or after 1 July 2012;

2.10.3 cargo ships, other than tankers, of 10,000 gross tonnage and upwards constructed on or after 1 July 2013;

2.10.4 cargo ships, other than tankers, of 3,000 gross tonnage and upwards but less than 10,000 gross tonnage constructed on or after 1 July 2014;

2.10.5 passenger ships of 500 gross tonnage and upwards constructed before 1 July 2012, not later than the first survey⁸ on or after 1 July 2014;

2.10.6 tankers of 3,000 gross tonnage and upwards constructed before 1 July 2012, not later than the first survey⁹ on or after 1 July 2015;

2.10.7 cargo ships, other than tankers, of 50,000 gross tonnage and upwards constructed before 1 July 2013, not later than the first survey¹⁰ on or after 1 July 2016;

2.10.8 cargo ships, other than tankers, of 20,000 gross tonnage and upwards but less than 50,000 gross tonnage constructed before 1 July 2013, not later than the first survey¹¹ on or after 1 July 2017; and

2.10.9 cargo ships, other than tankers, of 10,000 gross tonnage and upwards but less than 20,000 gross tonnage constructed before 1 July 2013, not later than the first survey¹² on or after 1 July 2018.

2.11 Administrations may exempt ships from the application of the requirements of paragraph 2.10 when such ships will be taken permanently out of service within two years after the implementation date specified in subparagraphs 2.10.5 to 2.10.9.”

⁶ Cf. the definition in chapter I, regulation I/2.

⁷ Refer to resolution MSC.128(75), "Performance standards for a Bridge Navigation Watch Alarm System (BNWAS)" (printed in Danish in Notices from the Danish Maritime Authority 5/2002).

⁸ Refer to the Unified interpretation of the term "first survey" referred to in SOLAS regulations (MSC.1/Circ.1290).

⁹ Refer to the Unified interpretation of the term "first survey" referred to in SOLAS regulations (MSC.1/Circ.1290).

¹⁰ Refer to the Unified interpretation of the term "first survey" referred to in SOLAS regulations (MSC.1/Circ.1290).

¹¹ Refer to the Unified interpretation of the term "first survey" referred to in SOLAS regulations (MSC.1/Circ.1290).

¹² Refer to the Unified interpretation of the term "first survey" referred to in SOLAS regulations (MSC.1/Circ.1290).

Chapter VI – Carriage of cargoes and oil fuels

Part A – General provisions

Regulation 1 – Application

1. Unless expressly provided otherwise, this chapter applies to the carriage of cargoes (except liquids in bulk, gases in bulk and those aspects of carriage covered by other chapters) which, owing to their particular hazards to ships or persons on board, may require special precautions in all ships to which the present regulations (*Notice B from the Danish Maritime Authority*) apply and in cargo ships of less than 500 gross tonnage. However, for cargo ships of less than 500 gross tonnage, the Administration, if it considers that the sheltered nature and conditions of voyage are such as to render the application of any specific requirements of part A or B of this chapter unreasonable or unnecessary, may take other effective measures to ensure the required safety for these ships.
2. To supplement the provisions of parts A and B of this chapter, each Contracting Government shall ensure that appropriate information on cargo and its stowage and securing is provided, specifying, in particular, precautions necessary for the safe carriage of such cargoes.¹³

Regulation 1-1 – Definitions

For the purpose of this chapter, unless expressly provided otherwise, the following definitions shall apply:

1. “IMSBC Code” means the International Maritime Solid Bulk Cargoes (IMSBC) Code adopted by the Maritime Safety Committee of the Organization by resolution MSC.268(85), as may be amended by the Organization, provided that such amendments are adopted, brought into force and take effect in accordance with the provisions of article VIII of the present Convention concerning the amendment procedures applicable to the Annex other than chapter I.
2. “Solid bulk cargo” means any cargo, other than liquid or gas, consisting of a combination of particles, granules or any larger pieces of material generally uniform in composition, which is loaded directly into the cargo spaces of a ship without any intermediate form of containment.

Regulation 1-2 – Requirements for the carriage of solid bulk cargoes other than grain

The carriage of solid bulk cargoes other than grain shall be in compliance with the relevant provisions of the *version of the IMSBC Code in force at any time*.

¹³ Refer to:

.1 the Code of Safe Practice for Cargo Stowage and Securing adopted by the Organization by resolution A.714(17), as amended;

.2 the Code of Safe Practice for Ships Carrying Timber Deck Cargoes adopted by the Organization by resolution A.715(17), as amended; MSC/Circ.525, Guidance note on precautions to be taken by the masters of ships of below 100 metres in length engaged in the carriage of logs; and MSC/Circ.548, Guidance note on precautions to be taken by masters of ships engaged in the carriage of timber cargoes; and

.3 the International Maritime Solid Bulk Cargoes (IMSBC) Code adopted by the Organization by resolution MSC.268(85);

.4 the relevant provisions in Resolution A.863(20), *Code of Safe Practice for the carriage of cargoes and persons by offshore supply vessels (OSV) Code*, as amended.

Regulation 2 – Cargo information

1. The shipper shall provide the master or his representative with appropriate information on the cargo in due time in advance of loading to enable the necessary precautions for proper stowage and safe carriage of the cargo to be put into effect. Such information¹⁴ shall be confirmed in writing¹⁵ and by appropriate shipping documents prior to loading the cargo.
2. The cargo information shall include:
 - 2.1. in the case of general cargo, and of cargo carried in cargo units, a general description of the cargo, the gross mass of the cargo or of the cargo units, and any relevant special properties of the cargo. For the purpose of this regulation the cargo information required in sub-chapter 1.9 of the Code of Safe Practice for Cargo Stowage and Securing, adopted by the Organization by resolution A.714 (17), as amended, shall be provided. Any amendment to subchapter 1.9 shall be adopted, brought into force and take effect in accordance with the provisions of article VIII of the SOLAS Convention concerning the amendment procedures applicable to the annex other than chapter I;
 - 2.2. in the case of solid bulk cargo, information as required by section 4 of the IMSBC Code.
3. Prior to loading cargo units on board ships, the shipper shall ensure that the gross mass of such units is in accordance with the gross mass declared on the shipping documents.

Regulation 3 – Oxygen analysis and gas detection equipment

1. When transporting a solid bulk cargo which is liable to emit a toxic or flammable gas, or cause oxygen depletion in the cargo space, an appropriate instrument for measuring the concentration of gas or oxygen in the air shall be provided together with detailed instructions for its use. Such an instrument shall be to the satisfaction of the Administration.
2. The Administration shall take steps to ensure that crews of ships are trained in the use of such instruments.

Regulation 4 – The use of pesticides in ships¹⁶

Appropriate precautions shall be taken in the use of pesticides in ships, in particular for the purposes of fumigation.

Regulation 5 – Stowage and securing

1. Cargoes, cargo units¹⁷ and cargo transport units¹⁸ carried on or below deck shall be so loaded, stowed and secured as to prevent as far as is practicable, throughout the voyage, damage or hazard to the ship and the persons on board, and loss of cargo overboard.

¹⁴ Refer to MSC/Circ.663, Form for cargo information.

¹⁵ Reference to documents in this regulation does not preclude the use of electronic data processing (EDP) and electronic data interchange (EDI) transmission techniques as an aid to paper documentation.

¹⁶ Refer to: .1 MSC/Circ.612 on Recommendations on the safe use of pesticides in ships, as amended by MSC/Circ.689 and MSC/Circ.746; .2 MSC.1/Circ.1264 on Recommendations on the safe use of pesticides in ships applicable to the fumigation of cargo holds; and .3 MSC.1/Circ.1265 on Recommendations on the safe use of pesticides in ships applicable to the fumigation of cargo transport units, *which have been introduced for Danish ships through Technical Regulation no. 9 of 18 August 2000 on the use of pesticides in ships.*

¹⁷ Refer to the Code of Safe Practice for Cargo Stowage and Securing, adopted by the Organization by resolution A.714(17), as amended.

2. Cargo, cargo units and cargo transport units shall be so packed and secured within the unit as to prevent, throughout the voyage, damage or hazard to the ship and the persons on board.
3. Appropriate precautions shall be taken during loading and transport of heavy cargoes or cargoes with abnormal physical dimensions to ensure that no structural damage to the ship occurs and to maintain adequate stability throughout the voyage.
4. Appropriate precautions shall be taken during loading and transport of cargo units and cargo transport units on board ro-ro ships, particularly with regard to the lashing arrangements on board such ships and on the cargo units and cargo transport units and with regard to the strength of the lashing points and lashings.
5. Freight containers shall not be loaded to more than the maximum gross weight indicated on the Safety Approval Plate under the International Convention for Safe Containers (CSC), as amended.
6. All cargoes, other than solid and liquid bulk cargoes, cargo units and cargo transport units, shall be loaded, stowed and secured throughout the voyage in accordance with the Cargo Securing Manual approved by the Administration. In ships with ro-ro spaces, as defined in regulation II-2/3.41, all securing of such cargoes, cargo units and cargo transport units, in accordance with the Cargo Securing Manual, shall be completed before the ship leaves the berth. The Cargo Securing Manual shall be drawn up to a standard at least equivalent to relevant guidelines developed by the Organization¹⁹.

Regulation 5-1 – Material safety data sheets

Ships carrying oil or oil fuel, as defined in regulation 1 of Annex 1 of the International Convention for the Prevention of Pollution from Ships, as modified by the Protocol of 1978 relating thereto, shall be provided with material safety data sheets, based on the recommendations developed by the Organization²⁰, prior to the loading of such oil as cargo in bulk or bunkering of oil fuel.

Part B – Special provisions for solid bulk cargoes

Regulation 6 – Acceptability for shipment

1. Prior to loading a solid bulk cargo, the master shall be in possession of comprehensive information on the ship's stability and on the distribution of cargo for the standard loading conditions. The method of providing such information shall be to the satisfaction of the Administration.²¹

Regulation 7 – Loading, unloading and stowage of solid bulk cargoes²²

1. For the purpose of this regulation, “terminal representative” means a person appointed by the terminal or other facility, where the ship is loading or unloading, who has responsibility for operations conducted by that terminal or facility with regard to the particular ship.

¹⁸ Refer to the International Maritime Dangerous Goods (IMDG) Code, adopted by the Organization by resolution MSC.122(75)

¹⁹ Refer to MSC/Circ.745, Guidelines for the preparation of the Cargo Securing Manual.

²⁰ Refer to the Recommendations for material safety data sheets (MSDS) for MARPOL Annex I oil cargo and oil fuel, adopted by the Organization by resolution MSC.286(86), as may be amended.

²¹ Refer to chapter II-1, regulation 5-1 on Stability information to be supplied to the master.

²² Refer to the Code of Practice for the Safe Loading and Unloading of Bulk Carriers (BLU Code) adopted by the Organization by resolution A.862(20), as amended, and the BLU Manual developed by the IMO, Guidance to the terminal representative on the loading and unloading of solid bulk cargoes.

2. To enable the master to prevent excessive stresses in the ship's structure, the ship shall be provided with a booklet, which shall be written in a language with which the ship's officers responsible for cargo operations are familiar. If this language is not English, the ship shall be provided with a booklet written also in the English language. The booklet shall, as a minimum, include:
 - 2.1. stability data, as required by regulation II-1/22 ;
 - 2.2. ballasting and deballasting rates and capacities;
 - 2.3. maximum allowable load per unit surface area of the tank top plating;
 - 2.4. maximum allowable load per hold;
 - 2.5. general loading and unloading instructions with regard to the strength of the ship's structure including any limitations on the most adverse operating conditions during loading, unloading, ballasting operations and the voyage;
 - 2.6. any special restrictions such as limitations on the most adverse operating conditions imposed by the Administration or organization recognized by it, if applicable; and
 - 2.7. where strength calculations are required, maximum permissible forces and moments on the ship's hull during loading, unloading and the voyage.
3. Before a solid bulk cargo is loaded or unloaded, the master and the terminal representative shall agree on a plan²³ which shall ensure that the permissible forces and moments on the ship are not exceeded during loading or unloading, and shall include the sequence, quantity and rate of loading or unloading, taking into consideration the speed of loading or unloading, the number of pours and the deballasting or ballasting capability of the ship. The plan and any subsequent amendments thereto shall be lodged with the appropriate authority of the port State.
4. The master and terminal representative shall ensure that loading and unloading operations are conducted in accordance with the agreed plan.
5. If during loading or unloading any of the limits of the ship referred to in paragraph 2 are exceeded or are likely to become so if the loading or unloading continues, the master has the right to suspend operation and the obligation to notify accordingly the appropriate authority of the port State with which the plan has been lodged. The master and the terminal representative shall ensure that corrective action is taken. When unloading cargo, the master and terminal representative shall ensure that the unloading method does not damage the ship's structure.
6. The master shall ensure that ship's personnel continuously monitor cargo operations. Where possible, the ship's draught shall be checked regularly during loading or unloading to confirm the tonnage figures supplied. Each draught and tonnage observation shall be recorded in a cargo log-book. If significant deviations from the agreed plan are detected, cargo or ballast operations or both shall be adjusted to ensure that the deviations are corrected.

Part C – Carriage of grain

Regulation 8 – Definitions

For the purposes of this part, unless expressly provided otherwise:

1. “International Grain Code” means the International Code for the Safe Carriage of Grain in Bulk adopted by the Maritime Safety Committee of the Organization by resolution MSC.23(59) as may

²³ Refer to IMO Res.A.862(20), Code of Practice for the Safe Loading and unloading of Bulk Carriers (BLU Code) , as amended, and the BLU Manual developed by the IMO, Guidance to the terminal representative on the loading and unloading of solid bulk cargoes.

be amended by the Organization, provided that such amendments are adopted, brought into force and take effect in accordance with the provisions of article VIII of the SOLAS Convention concerning the amendment procedures applicable to the annex other than chapter I.

2. The term “grain” includes wheat, maize (corn), oats, rye, barley, rice, pulses, seeds and processed forms thereof whose behaviour is similar to that of grain in its natural state.

Regulation 9 – Requirements for cargo ships carrying grain

1. In addition to any other applicable requirements of the present regulations, a cargo ship carrying grain shall comply with the requirements of the International Grain Code, and hold a document of authorization as required by that Code. For the purpose of this regulation, the requirements of the Code shall be treated as mandatory.
2. A ship without such a document shall not load grain until the master satisfies the Administration, or the Contracting Government of the port of loading on behalf of the Administration, that the ship will comply with the requirements of the International Grain Code in its proposed loaded condition.

Chapter VII – Carriage of dangerous goods

Part A – Carriage of dangerous goods in packaged form

Regulation 1 – Definitions

For the purpose of this chapter, unless expressly provided otherwise:

1. “IMDG Code” means the International Maritime Dangerous Goods (IMDG) Code adopted by the Maritime Safety Committee of the Organization by resolution MSC.122(75), as may be amended by the Organization, provided that such amendments are adopted, brought into force and take effect in accordance with the provisions of article VIII of the present Convention concerning the amendment procedures applicable to the annex other than chapter 1.²⁴
2. “Dangerous goods” mean the substances, materials and articles covered by the IMDG Code.
3. “Packaged form” means the form of containment specified in the IMDG Code.
4. “*The Baltic Sea agreement on the carriage of dangerous goods*” means the version in force of the “*Memorandum of Understanding for the Transport of Packaged Dangerous Goods on Ro-Ro Ships in the Baltic Sea*” on a co-ordinated use of the regulations on carriage by road, railroad and sea of dangerous goods in connection with “*carriage by sea similar to carriage by bridge*” on ro-ro ships in the Baltic Sea area.

Regulation 2 – Application²⁵

1. Unless expressly provided otherwise, this part applies to the carriage of dangerous goods in packaged form in all ships to which the present regulations apply and in cargo ships of less than 500 gross tonnage.
2. The provisions of this part do not apply to ships' stores and equipment.

²⁴ Most recent version 34-08, as adopted by resolution MSC.262(84).

²⁵ Refer to:

.1 part D, which contains special requirements for the carriage of INF cargo; and

.2 regulation II-2/19, which contains special requirements for ships carrying dangerous goods.

3. The carriage of dangerous goods in packaged form is prohibited except in accordance with the provisions of this chapter.
4. To supplement the provisions of this part, each Contracting Government shall issue, or cause to be issued, detailed instructions on emergency response and medical first aid relevant to incidents involving dangerous goods in packaged form, taking into account the guidelines developed by the Organization.²⁶

Regulation 3 – Requirements for the carriage of dangerous goods

1. The carriage of dangerous goods in packaged form shall be in compliance with the relevant provisions of the IMDG Code.
2. *The amendment of the IMDG Code most recently adopted by the Organisation and put into force shall be used; however, the adopted version of the IMDG Code may be used for an implementation period of one year until the relevant version enters into force internationally.*
3. *As an alternative to the IMDG Code, the Baltic Sea agreement on the carriage of dangerous goods may be used within the framework laid down in the agreement.*
4. *The IMDG Code and the supplements hereto concerning the Emergency Schedules Guide (EmS) as well as Medical First Aid Guide For Use in Accidents Involving Dangerous Goods (MFAG), as amended,²⁷ shall be available on board all ships²⁸ carrying packaged dangerous goods.*
 - 4.1. *For ships that only exceptionally carry dangerous goods or that regularly carry specific types of dangerous goods, it is however sufficient that only the information necessary for the safe carriage of the specific goods from the IMDG Code, EmS and MFAG is on board.*
5. *For ships carrying dangerous goods under the Baltic Sea agreement on the carriage of dangerous goods, a copy of this shall also be available.*

Regulation 4 – Documents²⁹

1. In all documents relating to the carriage of dangerous goods in packaged form by sea, the Proper Shipping Name of the goods shall be used (trade names alone shall not be used) and the correct description given in accordance with the classification set out in the IMDG Code.
2. The transport documents prepared by the shipper shall include, or be accompanied by, a signed certificate or a declaration that the consignment, as offered for carriage, is properly packaged, marked, labelled or placarded, as appropriate, and in proper condition for carriage.
3. The person(s) responsible for the packing/loading of dangerous goods in a cargo transport unit³⁰ shall provide a signed container/vehicle packing certificate stating that the cargo in the unit has been properly packed and secured and that all applicable transport requirements have been met. Such a certificate may be combined with the document referred to in paragraph 2.

²⁶ Refer to:

.1 the “Emergency Response Procedures for Ships Carrying Dangerous Goods (EmS Guide)” (MSC/Circ.1025); and
 .2 the “Medical First Aid Guide for Use in Accidents Involving Dangerous Goods” (MFAG) (MSC/Circ.857) published by the Organization.

²⁷ Refer to the IMDG Code adopted by the Organization by MSC resolution 122(75).

²⁸ The regulations and guidelines stipulated may be in electronic form, such as in the form of a CD-rom.

²⁹ References to documents in this regulation shall not preclude the use of digital systems as support in connection with paper documentation.

³⁰ Refer to the International Maritime Dangerous Goods (IMDG) Code, adopted by the Organization by resolution MSC.122(75).

4. Where there is due cause to suspect that a cargo transport unit in which dangerous goods are packed is not in compliance with the requirements of paragraph 2 or 3, or where a container/vehicle packing certificate is not available, the cargo transport unit shall not be accepted for carriage.
5. Each ship carrying dangerous goods in packaged form shall have a special list or manifest setting forth, in accordance with the classification set out in the IMDG Code, the dangerous goods on board and the location thereof. A detailed stowage plan, which identifies by class and sets out the location of all dangerous goods on board may be used in place of such a special list or manifest. A copy of one of these documents shall be made available before departure to the person or organization designated by the port State authority.
6. *In ships carrying dangerous goods in packaged form, information about the goods and about the measures to be taken in case of accidents with the goods shall be available to the crew.*

Regulation 5 – Cargo Securing Manual

Cargo, cargo units³¹ and cargo transport units shall be loaded, stowed and secured throughout the voyage in accordance with the Cargo Securing Manual approved by the Administration. The Cargo Securing Manual shall be drawn up to a standard at least equivalent to the guidelines developed by the Organization.³²

Regulation 6 – Reporting of incidents involving dangerous goods

1. When an incident takes place involving the loss or likely loss overboard of dangerous goods in packaged form into the sea, the master, or other person having charge of the ship, shall report the particulars of such an incident without delay and to the fullest extent possible to the nearest coastal State. The report shall be drawn up based on general principles and guidelines developed by the Organization.³³
2. In the event of the ship referred to in paragraph 1 being abandoned, or in the event of a report from such as ship being incomplete or unobtainable, the company, as defined in regulation IX/1.2, shall, to the fullest extent possible, assume the obligations placed upon the master by this regulation.

Part AA – Carriage of dangerous goods in packaged form by ro/ro ships

Regulation I – Special provisions for ro/ro ships

1. *In ships carrying ro-ro goods in accordance with the provisions of the Baltic Sea agreement on the carriage of dangerous goods, the master shall, with a view to proper stowage of dangerous goods, prior to boarding of vehicles, check the nature of goods in all ro-ro units, lorries, trailers, railway wagons and the like. This check of the nature of the goods may be carried out on the basis of the documentation/declaration pertaining to the ro-ro unit and the marking of the unit or on the basis of a declaration issued by the lorry driver, railway personnel or terminal personnel to the effect that the unit does not contain dangerous goods. The above check may, however, be omitted if a*

³¹ As defined in the Code of Safe Practice for Cargo Stowage and Securing, adopted by the Organization by resolution A.715(17), as amended.

³² Refer to the Guidelines for the preparation of the Cargo Securing Manual (MSC/Circ.745).

³³ Refer to the General principles for ship reporting systems and ship reporting requirements, including Guidelines for reporting incidents involving dangerous goods, harmful substances and/or marine pollutants, adopted by the Organization by resolution A.851(20).

proper system has been established for the sorting and control of the goods before boarding. Information on such arrangements in Denmark shall, before the check can be dispensed with, be submitted to the Danish Maritime Authority.

- 2. With regard to tank lorries, railway tank wagons or tank containers that contain dangerous goods or have not been cleaned since they last contained dangerous goods, in addition to the declaration referred to in regulation 4, paragraph 2, a declaration shall be presented on boarding issued by the lorry driver, the railway personnel or the terminal personnel, stating that the wagon or container was tight immediately prior to boarding. If the wagon or container is provided with durable marking referring to its dangerous goods content, even though it has been cleaned or has not most recently contained dangerous goods, a corresponding declaration hereof shall be issued.*
- 3. With regard to lorries and trailers, railway wagons or containers containing dangerous goods – including, if applicable, various kinds of dangerous goods – in addition to the declaration referred to in regulation 4, paragraph 2, a declaration shall be presented on boarding issued by the lorry driver, the railway personnel or the terminal personnel to the effect that the wagon or container was correctly stowed immediately prior to the boarding. If the wagon or container is provided with durable marking referring to its dangerous goods content, however empty, a corresponding declaration shall be issued.*
- 4. The lorry driver or the one handing over the transport unit for maritime transport shall, prior to presenting the declarations stipulated in paragraphs 1-3, satisfy himself that the information in question is correct.*

Regulation II – Control

- 1. The master shall, with the exception of the cases referred to in regulation 1, see to it that dangerous goods are marked as prescribed and that the visible part of the packaging complies with the regulations on packaging.*

Part A-1 – Carriage of dangerous goods in solid form in bulk

Regulation 7 – Definitions

“Dangerous goods in solid form in bulk” means any material, other than liquid or gas, consisting of a combination of particles, granules or any larger pieces of material, generally uniform in composition, which is covered by the IMDG Code and is loaded directly into the cargo spaces of a ship without any intermediate form of containment, and includes such materials loaded in a barge on a barge-carrying ship.

Regulation 7-1 – Application³⁴

1. Unless expressly provided otherwise, this part applies to the carriage of dangerous goods in solid form in bulk in all ships to which the present regulations apply and in cargo ships of less than 500 gross tonnage.
2. The carriage of dangerous goods in solid form in bulk is prohibited except in accordance with the provisions of this part.

³⁴ Refer to regulation II-2/19, which contains special requirements for ships carrying dangerous goods.

3. To supplement the provisions of this part, each Contracting Government shall issue, or cause to be issued, instructions on emergency response and medical first aid relevant to incidents involving dangerous goods in solid form in bulk,³⁵ taking into account the guidelines developed by the Organization.³⁶

Regulation 7-2 – Documents³⁷

1. In all documents relating to the carriage of dangerous goods in solid form in bulk by sea, the bulk cargo shipping name of the goods shall be used (trade names alone shall not be used). *Where the dangerous goods are provided with a UN number or an IMSBC number, this shall be stated in the document.*
2. Each ship carrying dangerous goods in solid form in bulk shall have a special list or manifest setting forth the dangerous goods on board and the location thereof. A detailed stowage plan, which identifies by class and sets out the location of all dangerous goods on board, may be used in place of such a special list or manifest. A copy of one of these documents shall be made available before departure to the person or organization designated by the port State authority.
3. *In ships carrying dangerous goods in solid form in bulk, information about the goods and about the measures to be taken in case of accidents with the goods shall be available to the crew.³⁸*
4. *The IMSBC Code, as amended, shall be available on board all ships carrying dangerous goods in solid form in bulk. For ships that only exceptionally carry dangerous goods in solid form in bulk or that regularly carry specific types of dangerous goods, it is however sufficient that only the information necessary for the safe carriage of the specific goods from the IMBC Code is on board.*

Regulation 7-3 – Stowage and segregation requirements

1. Dangerous goods in solid form in bulk shall be loaded and stowed safely and appropriately in accordance with the nature of the goods. Incompatible goods shall be segregated from one another.
2. Dangerous goods in solid form in bulk, which are liable to spontaneous heating or combustion, shall not be carried unless adequate precautions have been taken to minimize the likelihood of the outbreak of fire.
3. Dangerous goods in solid form in bulk, which give off dangerous vapours, shall be stowed in a well ventilated cargo space.
4. *The amendment of the IMDG Code and of the IMSBC Code most recently adopted by the Organisation and put into force shall be used; however, the adopted version of the IMDG Code may be used for an implementation period of one year until the relevant version enters into force internationally.*

³⁵ Refer to the International Maritime Solid Bulk Cargoes (IMSBC) Code, adopted by the Organization by resolution MSC.268(85), as amended.

³⁶ Refer to the Medical First Aid and the Medical First Aid Guide for Use in Accidents involving Dangerous Goods (MFAG) (MSC/ Circ.857).

³⁷ *References to documents in this regulation shall not preclude the use of digital systems as support in connection with paper documentation.*

³⁸ *Refer to regulation 5 of chapter II C of Technical Regulation A on occupational health in ships as regards carcinogenics.*

Regulation 7-4 – Reporting of incidents involving dangerous goods

1. When an incident takes place involving the loss or likely loss overboard of dangerous goods in solid form in bulk into the sea, the master, or other person having charge of the ship, shall report the particulars of such an incident without delay and to the fullest extent possible to the nearest coastal State. The report shall be drawn up based on general principles and guidelines developed by the Organization.³⁹
2. In the event of the ship referred to in paragraph 1 being abandoned, or in the event of a report from such a ship being incomplete or unobtainable, the company, as defined in regulation IX/1.2, shall to the fullest extent possible, assume the obligations placed upon the master by this regulation.

Regulation 7-5 – Requirements for the carriage of dangerous goods in solid form in bulk

The carriage of dangerous goods in solid form in bulk shall be in compliance with the relevant provisions of the IMSBC Code, as defined in regulation VI/1-1.1.

Part B – Construction and equipment of ships carrying dangerous liquid chemicals in bulk

Regulation 8 – Definitions

For the purpose of this part, unless expressly provided otherwise:

1. “International Bulk Chemical Code (IBC Code)” means the International Code for the Construction and Equipment of Ships Carrying Dangerous Chemicals in Bulk adopted by the Maritime Safety Committee of the Organization by resolution MSC.4(48), as may be amended by the Organization, provided that such amendments are adopted, brought into force and take effect in accordance with the provisions of article VIII of the SOLAS Convention concerning the amendment procedures applicable to the annex other than chapter I.⁴⁰
2. “Chemical tanker” means a cargo ship constructed or adapted and used for the carriage in bulk of any liquid product listed in chapter 17 of the International Bulk Chemical Code.
3. For the purpose of regulation 9, “ship constructed” means a ship the keel of which is laid or which is at a similar stage of construction.
4. “At a similar stage of construction” means the stage at which:
 - 4.1. construction identifiable with a specific ship begins; and
 - 4.2. assembly of that ship has commenced comprising at least 50 tonnes or 1% of the estimated mass of all structural material, whichever is less.

Regulation 9 – Application to chemical tankers

1. Unless expressly provided otherwise, this part applies to chemical tankers constructed on or after 1 July 1986 including those of less than 500 gross tonnage. Such tankers shall comply with the requirements of this part in addition to any other applicable requirements of the present regulations.
2. Any chemical tanker, irrespective of the date of construction, which undergoes repairs, alterations, modifications and outfitting related thereto shall continue to comply with at least the requirements

³⁹ Refer to the General principles for ship reporting systems and ship reporting requirements, including Guidelines for reporting incidents involving dangerous goods, harmful substances and/or marine pollutants, adopted by the Organization by resolution A.851(20).

⁴⁰ As amended most recently by resolutions MEPC.166(56) and MSC.219(82).

previously applicable to the ship. Such a ship, if constructed before 1 July 1986, shall, as a rule, comply with the requirements for a ship constructed on or after that date to at least the same extent as before undergoing such repairs, alterations, modifications or outfitting. Repairs, alterations and modifications of a major character, and outfitting related thereto, shall meet the requirements for a ship constructed on or after 1 July 1986 in so far as the Administration deems reasonable and practicable.

3. A ship, irrespective of the date of construction, which is converted to a chemical tanker shall be treated as a chemical tanker constructed on the date on which such conversion commenced.
4. *Existing chemical tankers constructed before 1 July 1986 shall comply with the regulations of the Code for the Construction and Equipment of Ships Carrying Dangerous Chemicals in Bulk (BCH Code), as amended.*⁴¹

Regulation 10 – Requirements for chemical tankers

1. A chemical tanker shall comply with the requirements of the International Bulk Chemical Code and shall, in addition to the requirements of regulation I/8, I/9, and I/10, as applicable, be surveyed and certified as provided for in that Code.
2. A chemical tanker holding a certificate issued pursuant to the provisions of paragraph 1 shall be subject to the control established in regulation I/19. For this purpose such certificate shall be treated as a certificate issued under regulation I/12 or I/13.

Part C – Construction and equipment of ships carrying liquefied gases in bulk

Regulation 11 – Definitions

For the purpose of this part, unless expressly provided otherwise:

1. “International Gas Carrier Code (IGC Code)” means the International Code for the Construction and Equipment of Ships Carrying Liquefied Gases in Bulk as adopted by the Maritime Safety Committee of the Organization by resolution MSC.5(48), as may be amended by the Organization, provided that such amendments are adopted, brought into force and take effect in accordance with the provisions of article VIII of the present Convention concerning the amendment procedures applicable to the annex other than chapter I.⁴²
2. “Gas carrier” means a cargo ship constructed or adapted and used for the carriage in bulk of any liquefied gas or other product listed in chapter 19 of the International Gas Carrier Code.
3. For the purpose of regulation 12, “ship constructed” means a ship the keel of which is laid or which is at a similar stage of construction.
4. “At a similar stage of construction” means the stage at which:
 - 4.1. construction identifiable with a specific ship begins; and
 - 4.2. assembly of that ship has commenced comprising at least 50 tonnes or 1% of the estimated mass of all structural material, whichever is less.

⁴¹ As amended by resolutions MEPC.144(54) and MSC.212(81).

⁴² Most recently amended by resolution MSC.220(82).

Regulation 12 – Application to gas carriers

1. Unless expressly provided otherwise, this part applies to gas carriers constructed on or after 1 July 1986 including those of less than 500 gross tonnage. Such gas carriers shall comply with the requirements of this part in addition to any other applicable requirements of the present regulations.
2. Any gas carrier, irrespective of the date of construction, which undergoes repairs, alterations, modifications and outfitting related thereto shall continue to comply with at least the requirements previously applicable to the ship. Such a ship if constructed before 1 July 1986 shall, as a rule, comply with the requirements for a ship constructed on or after that date to at least the same extent as before undergoing such repairs, alterations, modifications or outfitting. Repairs, alterations and modifications of a major character, and outfitting related thereto, shall meet the requirements for a ship constructed on or after 1 July 1986 in so far as the Administration deems reasonable and practicable.
3. A ship, irrespective of the date of construction, which is converted to a gas carrier shall be treated as a gas carrier constructed on the date on which such conversion commenced.

Regulation 13 – Requirements for gas carriers

1. A gas carrier shall comply with the requirements of the International Gas Carrier Code and shall, in addition to the requirements of regulation I/8, I/9 and I/10, as applicable, be surveyed and certified as provided for in that Code. For the purpose of this regulation, the requirements of the Code shall be treated as mandatory.
2. A gas carrier holding a certificate issued pursuant to the provisions of paragraph 1 shall be subject to the control established in regulation I/19. For this purpose such certificate shall be treated as a certificate issued under regulation I/12 or I/13.
3. *Existing gas tankers constructed before 1 July 1986 shall comply with the provisions of the Code for the Construction and Equipment of Ships Carrying Liquefied Gases in Bulk (Gas Carrier Code), as amended.*⁴³

Part D – Special requirements for the carriage of packaged irradiated nuclear fuel, plutonium and high-level radioactive wastes on board ships

Regulation 14 – Definitions

For the purpose of this part, unless expressly provided otherwise:

1. “INF Code” means the International Code for the Safe Carriage of Packaged Irradiated Nuclear Fuel, Plutonium and High-Level Radioactive Wastes on Board Ships, adopted by the Maritime Safety Committee of the Organization by resolution MSC.88 (71), as may be amended by the Organization, provided that such amendments are adopted, brought into force and take effect in accordance with the provisions of article VIII of the present Convention concerning the amendment procedures applicable to the annex other than chapter I.⁴⁴
2. “INF cargo” means packaged irradiated nuclear fuel, plutonium and high-level radioactive wastes carried as cargo in accordance with class 7 of the IMDG Code.

⁴³ As amended most recently by resolution MSC.225(82).

⁴⁴ As amended most recently by resolution MSC.241(83).

3. "Irradiated nuclear fuel" means material containing uranium, thorium and/or plutonium isotopes which has been used to maintain a self-sustaining nuclear chain reaction.
4. "Plutonium" means the resultant mixture of isotopes of that material extracted from irradiated nuclear fuel from reprocessing.
5. "High-level radioactive wastes" means liquid wastes resulting from the operation of the first stage extraction system or the concentrated wastes from subsequent extraction stages, in a facility for reprocessing irradiated nuclear fuel, or solids into which such liquid wastes have been converted.

Regulation 15 – Application to ships carrying INF cargo

1. Except as provided for in paragraph 2, this part shall apply to all ships regardless of the date of construction and size, including cargo ships of less than 500 gross tonnage, engaged in the carriage of INF cargo.
2. This part and the INF Code do not apply to warships, naval auxiliary or other vessels owned or operated by a Contracting Government and used, for the time being, only on government non-commercial service; however, each Administration shall ensure, by the adoption of appropriate measures not impairing operations or operational capabilities of such ships owned or operated by it, that such ships carrying INF cargo act in a manner consistent, so far as reasonable and practicable, with this part and the INF Code.
3. Nothing in this part or the INF Code shall prejudice the rights and duties of governments under international law and any action taken to enforce compliance shall be consistent with international law.

Regulation 16 – Requirements for ships carrying INF cargo

1. A ship carrying INF cargo shall comply with the requirements of the INF Code in addition to any other applicable requirements of the present regulations and shall be surveyed and certified as provided for in that Code.
2. A ship holding a certificate issued pursuant to the provisions of paragraph 1 shall be subject to the control established in regulations I/19 and XI/4. For this purpose, such certificate shall be treated as a certificate issued under regulation I/12 or I/13.

Chapter XXI – Prevention of oil pollution from ships

The following new part is inserted:

“Part VIII – Prevention of pollution during transfer of oil cargo between oil tankers at sea

Regulation 40 – Scope of application

1. The regulations contained in this chapter apply to oil tankers of 150 gross tonnage and above engaged in the transfer of oil cargo between oil tankers at sea (STS operations) and their STS operations conducted on or after 1 April 2012. However, STS operations conducted before that date but after the approval of the Administration of STS operations Plan required under regulation 41.1 shall be in accordance with the STS operations Plan as far as possible.
2. The regulations contained in this chapter shall not apply to oil transfer operations associated with fixed or floating platforms, including drilling rigs; floating production, storage and offloading facilities

(FPSOs) used for the offshore production and storage of oil; and floating storage units (FSUs) used for the offshore storage of produced oil.⁴⁵

3. The regulations contained in this chapter shall not apply to bunkering operations.

4. The regulations contained in this chapter shall not apply to STS operations necessary for the purpose of securing the safety of a ship or saving life at sea, or for combating specific pollution incidents in order to minimize the damage from pollution.

5. The regulations contained in this chapter shall not apply to STS operations where either of the ships involved is a warship, naval auxiliary or other ship owned or operated by a State and used, for the time being, only on government non-commercial service. However, each State shall ensure, by the adoption of appropriate measures not impairing operations or operational capabilities of such ships that the STS operations are conducted in a manner consistent, so far as is reasonable and practicable, with this chapter.

Regulation 41 – General rules on safety and environmental protection

1. Any oil tanker involved in STS operations shall carry on board a Plan prescribing how to conduct STS operations (STS operations Plan) not later than the date of the first annual, intermediate or renewal survey of the ship to be carried out on or after 1 January 2011. Each oil tanker's STS operations Plan shall be approved by the Administration. The STS operations Plan shall be written in the working language of the ship.

2. The STS operations Plan shall be developed taking into account the information contained in the best practice guidelines for STS operations identified by the Organization.⁴⁶ The STS operations Plan may be incorporated into an existing Safety Management System required by chapter IX of the International Convention for the Safety of Life at Sea, 1974, as amended, if that requirement is applicable to the oil tanker in question.

3. Any oil tanker subject to this chapter and engaged in STS operations shall comply with its STS operations Plan.

4. The person in overall advisory control of STS operations shall be qualified to perform all relevant duties, taking into account the qualifications contained in the best practice guidelines for STS operations identified by the Organization.⁴⁷

5. Records⁴⁸ of STS operations shall be retained on board for three years and be readily available for inspection by a Party to the MARPOL Convention.

Regulation 42 – Notification

1. Each oil tanker subject to this chapter that plans STS operations within the territorial sea or the exclusive economic zone of a Party to the MARPOL Convention shall notify that Party not less than 48 hours in advance of the scheduled STS operations. Where, in an exceptional case, all of the information

⁴⁵ Revised Annex I of MARPOL, chapter 7 (resolution MEPC.117(52)) and UNCLOS article 56 are applicable and address these operations.

⁴⁶ IMO's "Manual on Oil Pollution, Section I, Prevention", as amended, and the ICS and OCIMF "Ship-to-ship Transfer Guide, Petroleum", fourth edition, 2005.

⁴⁷ IMO's "Manual on Oil Pollution, Section I, Prevention", as amended, and the ICS and OCIMF "Ship-to-ship Transfer Guide, Petroleum", fourth edition, 2005.

⁴⁸ Revised Annex I of MARPOL chapters 3 and 4 (resolution MEPC.117(52)); requirements for recording bunkering and oil cargo transfer operations in the Oil Record Book, and any records required by the STS operations Plan.

specified in paragraph 2 is not available not less than 48 hours in advance, the oil tanker discharging the oil cargo shall notify the Party to the MARPOL Convention, not less than 48 hours in advance that an STS operation will occur and the information specified in paragraph 2 shall be provided to the Party at the earliest opportunity.

2. The notification specified in paragraph 1 of this regulation⁴⁹ shall include at least the following:
 - 2.1 name, flag, call sign, IMO Number and estimated time of arrival of the oil tankers involved in the STS operations;
 - 2.2 date, time and geographical location at the commencement of the planned STS operations;
 - 2.3 whether STS operations are to be conducted at anchor or underway;
 - 2.4 oil type and quantity;
 - 2.5 planned duration of the STS operations;
 - 2.6 identification of STS operations service provider or person in overall advisory control and contact information; and
 - 2.7 confirmation that the oil tanker has on board an STS operations Plan meeting the requirements of regulation 41.
3. If the estimated time of arrival of an oil tanker at the location or area for the STS operations changes by more than six hours, the master, owner or agent of that oil tanker shall provide a revised estimated time of arrival to the Party to the MARPOL Convention specified in paragraph 1 of this regulation.”

⁴⁹ The national operational contact point as listed in document MSC-MEPC.6/Circ.4 of 31 December 2007 or its subsequent amendments.



PASSENGER SHIP SAFETY CERTIFICATE

This certificate shall be supplemented by a Record of Equipment (Form P)

for $\frac{\text{an}^1}{\text{a short}}$ international voyage

Issued under the provisions of the
INTERNATIONAL CONVENTION FOR THE SAFETY OF LIFE AT SEA, 1974,
as modified by the Protocol of 1988 relating thereto

under the authority of the Government of

The Kingdom of Denmark

by **DANISH MARITIME AUTHORITY**

Particulars of ship²

Name of ship

Distinctive number or letters

Port of registry

Gross tonnage

Sea areas in which ship is certified
to operate (regulation IV/2)

IMO Number³

Date of build:

- Date of building contract

- Date on which keel was laid or ship was at
similar stage of construction

- Date of delivery

- Date on which work for a conversion or an
alteration or modification of a major
character was commenced (where
applicable)

¹ Delete as appropriate.

² Alternatively, the particulars of the ship may be placed horizontally in boxes.

³ In accordance with IMO ship identification number scheme adopted by the Organization by resolution A.600(15).

.....

All applicable dates shall be completed.

THIS IS TO CERTIFY:

1. That the ship has been surveyed in accordance with the requirements of regulation I/7 of the Convention.
2. That the survey showed that:
 - 2.1 the ship complied with the requirements of the Convention as regards:
 - .1 the structure, main and auxiliary machinery, boilers and other pressure vessels;
 - .2 the watertight subdivision arrangements and details;
 - .3 the following subdivision load lines;

Subdivision load lines assigned and marked on the ship's side at amidships (regulations II-1/18 ⁴)	Freeboard	To apply when the spaces in which passengers are carried include the following alternative spaces
P.1
P.2
P.3

- 2.2 the ship complied with the requirements of the Convention as regards structural fire protection, fire safety systems and appliances and fire control plans;
- 2.3 the life-saving appliances and the equipment of the lifeboats, liferafts and rescue boats were provided in accordance with the requirements of the Convention;
- 2.4 the ship was provided with a line-throwing appliance and radio installations used in life-saving appliances in accordance with the requirements of the Convention;
- 2.5 the ship complied with the requirements of the Convention as regards radio installations;

⁴ For ships constructed before 1 January 2009, the applicable subdivision notation "C.1, C.2 and C.3" should be used.

- 2.6 the functioning of the radio installation used in life-saving appliances complied with the requirements of the Convention;
- 2.7 the ship complied with the requirements of the Convention as regards shipborne navigational equipment, means of embarkation for pilots and nautical publications;
- 2.8 the ship was provided with lights, shapes, means of making sound signals and distress signals, in accordance with the requirements of the Convention and the International Regulations for Preventing Collisions at Sea in force;
- 2.9 in all other respects the ship complied with the relevant requirements of the Convention.

3. That an Exemption Certificate has/has not⁵ been issued.

This certificate is valid until

Completion date of the survey
on which this certificate is
based

(dd/mm/yyyy)

Issued at

(Place of issue of certificate)

.....
(Date of issue)

.....
(Signature of authorized official issuing the certificate)

(Seal or stamp of the issuing authority, as appropriate)

⁵ Delete as appropriate.

Endorsement where the renewal survey has been completed and regulation I/14(d) applies

The ship complies with the relevant requirements of the Convention, and this certificate shall, in accordance with regulation I/14(d) of the Convention, be accepted as valid until

.....
Signed:

.....
(Signature of authorized official)

Place:

Date:

.....
(Seal or stamp of the issuing authority, as appropriate)

Endorsement to extend the validity of the certificate until reaching the port of survey or for a period of grace where regulation I/14(e) or I/14(f) applies

This certificate shall, in accordance with regulation I/14(e)/I/14(f)¹ of the Convention, be accepted as valid until

.....
Signed:

.....
(Signature of authorized official)

Place:

Date:

.....
(Seal or stamp of the issuing authority, as appropriate)



*RECORD OF EQUIPMENT FOR THE
PASSENGER SHIP SAFETY CERTIFICATE (Form P)*

This Record shall be permanently attached to the
Passenger Ship Safety Certificate

**RECORD OF EQUIPMENT FOR COMPLIANCE
WITH THE INTERNATIONAL CONVENTION
FOR THE SAFETY OF LIFE AT SEA, 1974
as modified by the Protocol of 1988 relating thereto**

1 Particulars of ship

Name of ship

Distinctive number or letters

Number of passengers for which
certified

Minimum number of persons with
required qualifications to operate the
radio installations

2 Details of life-saving appliances

1 Total number of persons for which life-saving appliances are provided		
	Port side	Starboard side
2 Total numbers of lifeboats
2.1 Total numbers of persons accommodated by them
2.2 Number of partially enclosed lifeboats (regulation III/2 1 and LSA Code, section 4.5)
2.3 Number of totally enclosed lifeboats (regulation III/2 1 and LSA Code, section 4.6)
2.4 Other lifeboats
2.4.1 Number
2.5.2 Type

3 Details of radio facilities

Item	Actual provision
1 Primary systems
1.1 VHF radio installation
1.1.1 DSC encoder
1.1.2 DSC watch receiver
1.1.3 Radiotelephony
1.2 MF radio installation
1.2.1 DSC encoder
1.2.2 DSC watch receiver
1.2.3 Radiotelephony
1.3 MF/HF radio installation
1.3.1 DSC encoder
1.3.2 DSC watch receiver
1.3.3 Radiotelephony
1.3.4 Direct-printing radiotelegraphy
1.4 INMARSAT ship earth station
2 Secondary means of alerting
3 Facilities for reception of maritime safety information
3.1 NAVTEX receiver
3.2 EGC receiver
3.3 HF direct-printing radiotelegraph receiver
4 Satellite EPIRB
4.1 COSPASS-SARSAT
4.2 INMARSAT
5 VHF EPIRB
6 Ship's search and rescue locating device
6.1 Radar search and rescue transponder (SART)
6.2 AIS search and rescue transmitter (AIS-SART)

4 *Methods used to ensure availability of radio facilities* (regulations IV/15.6 and 15.7)

- 4.1 Duplication of equipment
- 4.2 Shore-based maintenance
- 4.3 At-sea maintenance capability

5 *Details of navigational systems and equipment*

Item	Actual provision
1.1 Standard magnetic compass ¹
1.2 Spare magnetic compass ¹
1.3 Gyro-compass ¹
1.4 Gyro-compass heading repeater ¹
1.5 Gyro-compass bearing repeater ¹
1.6 Heading or track control system ¹
1.7 Pelorus or compass bearing device ¹
1.8 Means of correcting heading and bearings
1.9 Transmitting heading device (THD) ¹
2.1 Nautical charts/Electronic chart display and information system (ECDIS) ^{2, 1}
2.2 Back-up arrangements for ECDIS
2.3 Nautical publications
2.4 Back-up arrangements for electronic nautical publications
3.1 Receiver for a global navigation satellite system/terrestrial radionavigation system ^{2, 1}
3.2 9 GHz radar ¹
3.3 Second radar (3 GHz/9 GHz ²) ¹
3.4 Automatic radar plotting aid (ARPA) ¹
3.5 Automatic tracking aid
3.6 Second automatic tracking aid
3.7 Electronic plotting aid ¹
4.1 Automatic identification system (AIS)
4.2 Long-range identification and tracking system

¹ Alternative means of meeting this requirement are permitted under regulation V/19. In case of other means they shall be specified.

² Delete as appropriate.

5 Details of navigational systems and equipment (continued)

Item	Actual provision
5 Voyage data recorder (VDR)
6.1 Speed and distance measuring device (through the water) ¹
6.2 Speed and distance measuring device (over the ground in the forward and athwartship direction) ¹
7 Echo-sounding device ¹
8.1 Rudder, propeller, thrust, pitch and operational mode indicator ¹
8.2 Rate-of-turn indicator ¹
9 Sound reception system ¹
10 Telephone to emergency steering position ¹
11 Daylight signaling lamp ¹
12 Radar reflector ¹
13 International Code of Signals
14 Bridge navigational watch alarm system (BNWAS)

THIS IS TO CERTIFY that this Record is correct in all respects

Issued at

.....
(Place of issue of the Record)

.....
(Date of issue)

.....
(Signature of authorized official issuing the Record)

(Seal or stamp of the issuing authority, as appropriate)

¹ Alternative means of meeting this requirement are permitted under regulation V/19. In case of other means they shall be specified.



CARGO SHIP SAFETY EQUIPMENT CERTIFICATE

This certificate shall be supplemented by a Record of Equipment
(Form E)

Issued under the provisions of the
INTERNATIONAL CONVENTION FOR THE SAFETY OF LIFE
AT SEA, 1974 as modified by the Protocol of 1988 relating thereto

under the authority of the Government of

The Kingdom of Denmark

by **DANISH MARITIME AUTHORITY**

Particulars of ship

Name of ship

Distinctive number or letters

Port of registry

Gross tonnage

Deadweight of ship (metric tons)¹

Length of ship (regulation III/3.12)

IMO Number

Type of ship²

Bulk carrier

Oil tanker

Chemical tanker

Gas carrier

Cargo ship other than any of the above

Date on which keel was laid or ship was at a similar stage of
construction or, where applicable, date on which work for a
conversion or an alteration or modification of a major
character was commenced

.....

¹ For oil tankers, chemical tankers and gas carriers only.

² Delete as appropriate.

THIS IS TO CERTIFY:

1. That the ship has been surveyed in accordance with the requirements of regulation I/8 of the Convention.
2. That the survey showed that:
 - 2.1 the ship complied with the requirements of the Convention as regards fire safety systems and appliances and fire control plans;
 - 2.2 the life-saving appliances and the equipment of the lifeboats, liferafts and rescue boats were provided in accordance with the requirements of the Convention;
 - 2.3 the ship was provided with a line-throwing appliance and radio installations used in life-saving appliances in accordance with the requirements of the Convention;
 - 2.4 the ship complied with the requirements of the Convention as regards shipborne navigational equipment, means of embarkation for pilots and nautical publications;
 - 2.5 the ship was provided with lights, shapes and means of making sound signals and distress signals, in accordance with the requirements of the Convention and the International Regulations for Preventing Collisions at Sea in force;
 - 2.6 in all other respects the ship complied with the relevant requirements of the Convention.
3. That an Exemption Certificate has/has not¹ been issued.

This certificate is valid until² subject to the annual and periodical surveys in accordance with regulation I/8 of the Convention.

Issued at

.....
(Place of issue of certificate)

Completion date of the survey on which this certificate is based

.....
dd/mm/yyyy

.....
(Date of issue)

.....
(Signature of authorized official issuing the certificate)

(Seal or stamp of the issuing authority, as appropriate)

¹ Delete as appropriate.

² Insert the date of expiry as specified by the Administration in accordance with regulation I/14(a) of the Convention. The day and month of this date correspond to the anniversary date as defined in regulation I/2(n) of the Convention, unless amended in accordance with regulation I/14(h).

Endorsement for annual and periodical surveys

THIS IS TO CERTIFY that, at a survey required by regulation I/8 of the Convention, the ship was found to comply with the relevant requirements of the Convention.

Annual survey:

Signed:

.....
(Signature of authorized official)

Place:

Date:

.....
(Seal or stamp of the issuing authority, as appropriate)

Annual/Periodical¹ survey:

Signed:

.....
(Signature of authorized official)

Place:

Date:

.....
(Seal or stamp of the issuing authority, as appropriate)

Annual/Periodical¹ survey:

Signed:

.....
(Signature of authorized official)

Place:

Date:

.....
(Seal or stamp of the issuing authority, as appropriate)

Annual survey:

Signed:

.....
(Signature of authorized official)

Place:

Date:

.....
(Seal or stamp of the issuing authority, as appropriate)

¹ Delete as appropriate.

Annual/periodical survey in accordance with regulation I/14(h)(iii)

THIS IS TO CERTIFY that, at the annual/periodical¹ survey in accordance with regulation I/14(h)(iii) of the Convention, the ship was found to comply with the relevant requirements of the Convention.

Signed:
(Signature of authorized official)

Place:

Date:

(Seal or stamp of the issuing authority, as appropriate)

Endorsement to extend the certificate if valid for less than 5 years where regulation I/14(c) applies

The ship complies with the relevant requirements of the Convention, and this certificate shall, in accordance with regulation I/14(c) of the Convention, be accepted as valid until

.....
Signed:
(Signature of authorized official)

Place:

Date:

(Seal or stamp of the issuing authority, as appropriate)

Endorsement where the renewal survey has been completed and regulation I/14(d) applies

The ship complies with the relevant requirements of the Convention, and this certificate shall, in accordance with regulation I/14(d) of the Convention, be accepted as valid until

.....
Signed:
(Signature of authorized official)

Place:

Date:

(Seal or stamp of the issuing authority, as appropriate)

¹ Delete as appropriate.

Endorsement to extend the validity of the certificate until reaching the port of survey or a period of grace where regulation I/14(e) or I/14(f) applies

This certificate shall, in accordance with regulation I/14(e)/I/14(f)¹ of the Convention, be accepted as valid until

.....
Signed:

.....
(Signature of authorized official)

Place:

Date:

.....
(Seal or stamp of the issuing authority, as appropriate)

Endorsement for advancement of anniversary date where regulation I/14(h) applies

In accordance with regulation I/14(h) of the Convention, the new anniversary date is

.....
Signed:

.....
(Signature of authorized official)

Place:

Date:

.....
(Seal or stamp of the issuing authority, as appropriate)

In accordance with regulation I/14(h) of the Convention, the new anniversary date is

.....
Signed:

.....
(Signature of authorized official)

Place:

Date:

.....
(Seal or stamp of the issuing authority, as appropriate)



*RECORD OF EQUIPMENT FOR THE
CARGO SHIP SAFETY EQUIPMENT CERTIFICATE (Form E)*

This Record shall be permanently attached to the
Cargo Ship Safety Certificate

**RECORD OF EQUIPMENT FOR COMPLIANCE
WITH THE INTERNATIONAL CONVENTION
FOR THE SAFETY OF LIFE AT SEA, 1974
as modified by the Protocol of 1988 relating thereto**

1 Particulars of ship

Name of ship

Distinctive number or letters

2 Details of life-saving appliances

1	Total number of persons for which life-saving appliances are provided	
		Port side	Starboard side
2	Total numbers of lifeboats
2.1	Total numbers of persons accommodated by them
2.2	Number of totally enclosed lifeboats (regulation III/3 1 and LSA Code, section 4.6)
2.3	Number of lifeboats with a self-contained air support system (regulation III/3 1 and LSA Code, section 4.8)
2.4	Number of fire-protected lifeboats (regulation III/3 1 and LSA Code, section 4.9)
2.5	Other lifeboats
2.5.1	Number
2.5.2	Type

2 *Details of life-saving appliances (continued)*

2.6	Number of freefall lifeboats
2.6.1	Totally enclosed (regulation III/3 1 and LSA Code, section 4.7)
2.6.2	Self-contained (regulation III/3 1 and LSA Code, section 4.8)
2.6.3	Fire-protected (regulation III/3 1 and LSA Code, section 4.9)
3	Number of motor lifeboats (included in the total lifeboats shown above)
3.1	Number of lifeboats fitted with searchlights
4.	Number of rescue boats
4.1	Number of boats which are included in the total lifeboats shown above
5	Liferafts
5.1	Those for which approved launching appliances are required
5.1.1	Number of liferafts
5.1.2	Number of persons accommodated by them
5.2	Those for which approved launching appliances are not required
5.2.1	Number of liferafts
5.2.2	Number of persons accommodated by them
5.3	Number of liferafts required by regulation III/31.1.4
6	Number of lifebuoys
7	Number of lifejackets
8	Immersion suits
8.1	Total number
8.2	Number of suits complying with the requirements for lifejackets
9	Radio installations used in life-saving appliances
9.1	Number of search and rescue locating devices
9.1.1	Radar search and rescue transponders (SART)
9.1.2	AIS search and rescue transmitters (AIS-SART)
9.2	Number of two-way VHF Radiotelephone apparatus

3 Details of navigational systems and equipment

Item	Actual provision
1.1 Standard magnetic compass ¹
1.2 Spare magnetic compass ¹
1.3 Gyro-compass ¹
1.4 Gyro-compass heading repeater ¹
1.5 Gyro-compass bearing repeater ¹
1.6 Heading or track control system ¹
1.7 Pelorus or compass bearing device ¹
1.8 Means of correcting heading and bearings
1.9 Transmitting heading device (THD) ¹
2.1 Nautical charts/Electronic chart display and information system (ECDIS) ^{2, 1}
2.2 Back-up arrangements for ECDIS
2.3 Nautical publications
2.4 Back-up arrangements for electronic nautical publications
3.1 Receiver for a global navigation satellite system/terrestrial radionavigation system ^{2, 1}
3.2 9 GHz radar ¹
3.3 Second radar (3 GHz/9 GHz) ^{2, 1}
3.4 Automatic radar plotting aid (ARPA) ¹
3.5 Automatic tracking aid
3.6 Second automatic tracking aid
3.7 Electronic plotting aid ¹
4.1 Automatic identification system (AIS)
4.2 Long-range identification tracking system
5.1 Voyage data recorder (VDR)
5.2 Simplified voyage data recorder (S-VDR) ²
6.1 Speed and distance measuring device (through the water) ¹
6.2 Speed and distance measuring device (over the ground in the forward and athwart ship direction) ¹
6.3 Echo-sounding device ¹

¹ Alternative means of meeting this requirement are permitted under regulation V/19. In case of other means they shall be specified.

² Delete as appropriate.

3 Details of navigational systems and equipment (continued)

Item	Actual provision
7.1 Rudder, propeller, thrust, pitch and operational mode indicator ¹
7.2 Rate-of-turn indicator ¹
8 Sound reception system ¹
9 Telephone to emergency steering position ¹
10 Daylight signaling lamp ¹
11 Radar reflector ¹
12 International Code of Signals
13 IAMSAR Manual, Volume III
14 Bridge navigational watch alarm system (NBWAS)

THIS IS TO CERTIFY that this Record is correct in all respects

Issued at

.....
(Place of issue of record)

.....
(Date of issue)

.....
(Signature of authorized official issuing the record)

(Seal or stamp of the issuing authority, as appropriate)

¹ Alternative means of meeting this requirement are permitted under regulation V/19. In case of other means they shall be specified.
² Delete as appropriate.



CARGO SHIP SAFETY CERTIFICATE

This certificate shall be supplemented by a Record of Equipment (Form C)

Issued under the provisions of the
INTERNATIONAL CONVENTION FOR THE SAFETY OF LIFE AT SEA, 1974,
as modified by the Protocol of 1988 relating thereto

under the authority of the Government of

The Kingdom of Denmark

DANISH MARITIME AUTHORITY

by

Particulars of ship

Name of ship

Distinctive number or letters

Port of registry

Gross tonnage

Deadweight of ship (metric tons)¹

Length of ship (regulation III/3.12)

Sea areas in which ship is certified to
operate (regulation IV/2)

IMO Number

*Type of ship*²

Bulk carrier

Oil tanker

Chemical tanker

Gas carrier

Cargo ship other than any of the above

Date of build:

- Date of building contract

- Date on which keel was laid or ship was at similar stage of
construction

- Date of delivery

- Date on which work for a conversion or an alteration or modification
of a major character was commenced (where applicable)

All applicable dates shall be completed.

¹ For oil tankers, chemical tankers and gas carriers only.

² Delete as appropriate.

THIS IS TO CERTIFY:

1. That the ship has been surveyed in accordance with the requirements of regulation I/8, I/9 and I/10 of the Convention.
2. That the survey showed that:
 - 2.1 the condition of the structure, machinery and equipment as defined in regulation I/10 was satisfactory and the ship complied with the relevant requirements of chapter II-1 and chapter II-2 of the Convention (other than those relating to fire safety systems and appliances and fire control plans);
 - 2.2 the last two inspections of the outside of the ship's bottom took place on and
(dates)
 - 2.3 the ship complied with the requirements of the Convention as regards fire safety systems and appliances and fire control plans;
 - 2.4 the life-saving appliances and the equipment of the lifeboats, liferafts and rescue boats were provided in accordance with the requirements of the Convention;
 - 2.5 the ship was provided with a line-throwing appliance and radio installations used in life-saving appliances in accordance with the requirements of the Convention;
 - 2.6 the ship complied with the requirements of the Convention as regards radio installations;
 - 2.7 the functioning of the radio installation used in life-saving appliances complied with the requirements of the Convention;
 - 2.8 the ship complied with the requirements of the Convention as regards shipborne navigational equipment, means of embarkation for pilots and nautical publications;
 - 2.9 the ship was provided with lights, shapes, means of making sound signals and distress signals, in accordance with the requirements of the Convention and the International Regulations for Preventing Collisions at Sea in force;
 - 2.10 in all other respects the ship complied with the relevant requirements of the Convention.
- 3 That an Exemption Certificate has/has not¹ been issued.

¹ Delete as appropriate.

This certificate is valid until¹ subject to the annual, intermediate and periodical surveys and inspections of the outside of the ship's bottom in accordance with regulation I/8, I/9 and I/10 of the Convention.

Completion date of the survey on which this certificate is based
(dd/mm/yyyy)

Issued at
(Place of issue of certificate)

..... Date of issue) (Signature of authorized official issuing the certificate)
(Seal or stamp of the issuing authority, as appropriate)

¹ Insert the date of expiry as specified by the Administration in accordance with regulation I/14(a) of the Convention. The day and month of this date correspond to the anniversary date as defined in regulation I/2(n) of the Convention, unless amended in accordance with regulation I/14(h).

Endorsement for annual and intermediate surveys relating to structure, machinery and equipment referred to in paragraph 2.1 of this certificate

THIS IS TO CERTIFY that, at a survey required by regulation I/10 of the Convention, the ship was found to comply with the relevant requirements of the Convention.

Annual survey: Signed:
(Signature of authorized official)

Place:

Date:

(Seal or stamp of the issuing authority, as appropriate)

Annual/Intermediate¹ survey: Signed:
(Signature of authorized official)

Place:

Date:

(Seal or stamp of the issuing authority, as appropriate)

Annual/Intermediate⁶³ survey: Signed:
(Signature of authorized official)

Place:

Date:

(Seal or stamp of the issuing authority, as appropriate)

Annual survey: Signed:
(Signature of authorized official)

Place:

Date:

(Seal or stamp of the issuing authority, as appropriate)

¹ Delete as appropriate.

Annual/intermediate survey in accordance with regulation I/14(h)(iii)

THIS IS TO CERTIFY that, at an annual/intermediate¹ surveyed in accordance with regulation I/10 and I/14(h)(iii) of the Convention, the ship was found to comply with the relevant requirements of the Convention.

Signed:
(Signature of authorized official)

Place:

Date:

(Seal or stamp of the issuing authority, as appropriate)

Endorsement for inspections of the outside of the ship's bottom²

THIS IS TO CERTIFY that, at an inspection required by regulation I/10 of the Convention, the ship was found to comply with the relevant requirements of the Convention.

First inspection: Signed:
(Signature of authorized official)

Place:

Date:

(Seal or stamp of the issuing authority, as appropriate)

Second inspection: Signed:
(Signature of authorized official)

Place:

Date:

(Seal or stamp of the issuing authority, as appropriate)

¹ Delete as appropriate.

² Provisions may be made for additional inspections.

**Endorsement for annual and periodical surveys relating to life-saving appliances
and other equipment referred to in paragraphs 2.3, 2.4, 2.5, 2.8 and 2.9 of
this certificate**

THIS IS TO CERTIFY that, at a survey required by regulation I/8 of the Convention, the ship was found to comply with the relevant requirements of the Convention.

Annual survey: Signed:
(Signature of authorized official)

Place:

Date:
(Seal or stamp of the issuing authority, as appropriate)

Annual/Periodical¹ survey: Signed:
(Signature of authorized official)

Place:

Date:
(Seal or stamp of the issuing authority, as appropriate)

Annual/Periodical⁶³ survey: Signed:
(Signature of authorized official)

Place:

Date:
(Seal or stamp of the issuing authority, as appropriate)

Annual survey: Signed:
(Signature of authorized official)

Place:

Date:
(Seal or stamp of the issuing authority, as appropriate)

¹ Delete as appropriate.

Annual/periodical survey in accordance with regulation I/14(h)(iii)

THIS IS TO CERTIFY that, at an annual/periodical¹ survey in accordance with regulations I/8 and I/14(h)(iii) of the Convention, the ship was found to comply with the relevant requirements of the Convention.

Signed:
(Signature of authorized official)

Place:

Date:

(Seal or stamp of the issuing authority, as appropriate)

¹ Delete as appropriate.

Endorsement for annual and periodical surveys relating to radio installations referred to in paragraphs 2.6 and 2.7 of this certificate

THIS IS TO CERTIFY that, at a survey required by regulation I/9 of the Convention, the ship was found to comply with the relevant requirements of the Convention.

Periodical survey: Signed:
(Signature of authorized official)

Place:

Date:

(Seal or stamp of the issuing authority, as appropriate)

Periodical survey: Signed:
(Signature of authorized official)

Place:

Date:

(Seal or stamp of the issuing authority, as appropriate)

Periodical survey: Signed:
(Signature of authorized official)

Place:

Date:

(Seal or stamp of the issuing authority, as appropriate)

Periodical survey: Signed:
(Signature of authorized official)

Place:

Date:

(Seal or stamp of the issuing authority, as appropriate)

Periodical survey in accordance with regulation I/14(h)(iii)

THIS IS TO CERTIFY that, at a periodical survey in accordance with regulations I/9 and I/14(h)(iii) of the Convention, the ship was found to comply with the relevant requirements of the Convention.

Signed:
(Signature of authorized official)

Place:

Date:

(Seal or stamp of the issuing authority, as appropriate)

Endorsement to extend the certificate if valid for less than 5 years where regulation I/14(c) applies

The ship complies with the relevant requirements of the Convention, and this certificate shall, in accordance with regulation I/14(c) of the Convention, be accepted as valid until

.....
Signed:
(Signature of authorized official)

Place:

Date:

(Seal or stamp of the issuing authority, as appropriate)

Endorsement where the renewal survey has been completed and regulation I/14(d) applies

The ship complies with the relevant requirements of the Convention, and this certificate shall, in accordance with regulation I/14(d) of the Convention, be accepted as valid until

.....
Signed:
(Signature of authorized official)

Place:

Date:

(Seal or stamp of the issuing authority, as appropriate)

**Endorsement to extend the validity of the certificate until reaching the port of survey
or a period of grace where regulation I/14(e) or I/14(f) applies**

This certificate shall, in accordance with regulation I/14(e)/I/14(f)¹ of the Convention, be
accepted as valid until

Signed:
(Signature of authorized official)

Place:

Date:

(Seal or stamp of the issuing authority, as appropriate)

Endorsement for advancement of anniversary date where regulation I/14(h) applies

In accordance with regulation I/14(h) of the Convention, the new anniversary date is

.....
Signed:
(Signature of authorized official)

Place:

Date:

(Seal or stamp of the issuing authority, as appropriate)

In accordance with regulation I/14(h) of the Convention, the new anniversary date is

.....
Signed:
(Signature of authorized official)

Place:

Date:

(Seal or stamp of the issuing authority, as appropriate)

¹ Delete as appropriate.



*RECORD OF EQUIPMENT FOR THE
CARGO SHIP SAFETY CERTIFICATE (Form C)*

This Record shall be permanently attached to the
Cargo Ship Safety Certificate

**RECORD OF EQUIPMENT FOR COMPLIANCE
WITH THE INTERNATIONAL CONVENTION
FOR THE SAFETY OF LIFE AT SEA, 1974
as modified by the Protocol of 1988 relating thereto**

1 Particulars of ship

Name of ship

Distinctive number or letters

Minimum number of persons with required
qualifications to operate the radio installations

2 Details of life-saving appliances

1	Total number of persons for which life-saving appliances are provided	
		Port side	Starboard side
2	Total numbers of lifeboats
2.1	Total numbers of persons accommodated by them
2.2	Number of totally enclosed lifeboats (regulation III/3 1 and LSA Code section 4.6)
2.3	Number of lifeboats with a self contained air support system (regulation III/3 1 and LSA Code section 4.8)
2.4	Number of fire-protected lifeboats (regulation III/3 1 and LSA Code section 4.9)
2.5	Other lifeboats
2.5.1	Number
2.5.2	Type

2 Details of life-saving appliances (continued)

2.6	Number of free-fall lifeboats
2.6.1	Totally enclosed (regulation III/3 1 and LSA Code section 4.7)
2.6.2	Self-contained (regulation III/3 1 and LSA Code section 4.8)
2.6.3	Fire-protected (regulation III/3 1 and LSA Code section 4.9)
3	Number of motor lifeboats included in the total lifeboats shown above
3.1	Number of lifeboats fitted with searchlights
4.	Number of rescue boats
4.1	Number of boats which are included in the total lifeboats shown above
5	Liferafts
5.1	Those for which approved launching appliances are required
5.1.1	Number of liferafts
5.1.2	Number of persons accommodated by them
5.2	Those for which approved launching appliances are not required
5.2.1	Number of liferafts
5.2.2	Number of persons accommodated by them
5.3	Number of liferafts required by regulation III/31.1.4
6	Number of lifebuoys
7	Number of lifejackets
8	Immersion suits
8.1	Total number
8.2	Number of suits complying with the requirements for lifejackets
9	Radio installations used in life-saving appliances
9.1	Number of search and rescue locating devices
9.1.1	Radar search and rescue transponders (SART)
9.1.2	AIS search and rescue transmitters (AIS-SART)
9.2	Number of two-way VHF Radiotelephone apparatus

3 *Details of radio facilities*

Item	Actual provision
1 Primary systems
1.1 VHF radio installation
1.1.1 DSC encoder
1.1.2 DSC watch receiver
1.1.3 Radiotelephony
1.2 MF radio installation
1.2.1 DSC encoder
1.2.2 DSC watch receiver
1.2.3 Radiotelephony
1.3 MF/HF radio installation
1.3.1 DSC encoder
1.3.2 DSC watch receiver
1.3.3 Radiotelephony
1.3.4 Direct-printing radiotelegraphy
1.4 INMARSAT ship earth station
2 Secondary means of alerting
3 Facilities for reception of maritime safety information
3.1 NAVTEX receiver
3.2 EGC receiver
3.3 HF direct-printing radiotelegraph receiver
4 Satellite EPIRB
4.1 COSPASS-SARSAT
4.2 INMARSAT
5 VHF EPIRB
6 Ship's search and rescue locating device
6.1 Radar search and rescue transponder (SART)
6.2 AIS search and rescue transmitter (AIS-SART)

4 *Methods used to ensure availability of radio facilities*
(regulations IV/15.6 and 15.7)

4.1 Duplication of equipment
4.2 Shore based maintenance
4.3 At-sea maintenance capability

5 Details of navigational systems and equipment

Item	Actual provision
1.1 Standard magnetic compass ¹
1.2 Spare magnetic compass ¹
1.3 Gyro-compass ¹
1.4 Gyro-compass heading repeater ¹
1.5 Gyro-compass bearing repeater ¹
1.6 Heading or track control system ¹
1.7 Pelorus or compass bearing device ¹
1.8 Means of correcting heading and bearings
1.9 Transmitting heading device (THD) ¹
2.1 Nautical charts/Electronic chart display and information system (ECDIS) ^{2, 1}
2.2 Back-up arrangements for ECDIS
2.3 Nautical publications
2.4 Back-up arrangements for electronic nautical publications
3.1 Receiver for a global navigation satellite system/terrestrial radionavigation system ^{2, 1}
3.2 9 GHz radar ¹
3.3 Second radar (3 GHz/9 GHz ²) ¹
3.4 Automatic radar plotting aid (ARPA) ¹
3.5 Automatic tracking aid
3.6 Second automatic tracking aid
3.7 Electronic plotting aid ¹
4.1 Automatic identification system (AIS)
4.2 Long-range identification tracking system
5.1 Voyage data recorder (VDR)
5.2 Simplified voyage data recorder (S-VDR) ¹
6.1 Speed and distance measuring device (through the water) ¹
6.2 Speed and distance measuring device (over the ground in the forward and athwartship direction) ¹
7 Echo-sounding device ¹

¹ Alternative means of meeting this requirement are permitted under regulation V/19. In case of other means they shall be specified.

² Delete as appropriate.

5 Details of navigational systems and equipment (continued)

Item	Actual provision
8.1 Rudder, propeller, thrust, pitch and operational mode indicator ¹
8.2 Rate-of-turn indicator ¹
9 Sound reception system ¹
10 Telephone to emergency steering position ¹
11 Daylight signaling lamp ¹
12 Radar reflector ¹
13 International Code of Signals
14 IAMSAR Manual, Volume III
15 Bridge navigational watch alarm system (BNWAS)

THIS IS TO CERTIFY that this Record is correct in all respects

Issued at

.....
(Place of issue of the record)

.....
(Date of issue)

.....
(Signature of duly authorized official issuing the record)

(Seal or stamp of the issuing authority, as appropriate)

¹ Alternative means of meeting this requirement are permitted under regulation V/19. In case of other means they shall be specified.



NUCLEAR PASSENGER SHIP SAFETY CERTIFICATE

This certificate shall be supplemented by a Record of Equipment (Form PNUC)

for $\frac{\text{an}^*}{\text{a short}}$ international voyage

Issued under the provisions of the
INTERNATIONAL CONVENTION FOR THE SAFETY OF LIFE AT SEA,
1974,

as modified by the Protocol of 1988 relating thereto

under the authority of the Government of

The Kingdom of Denmark

By **DANISH MARITIME AUTHORITY**

Particulars of ship¹

Name of ship

Distinctive number or letters

Port of registry

Gross tonnage

Sea areas in which ship is certified
to operate (regulation IV/2)

IMO Number

Date on which keel was laid or ship was at a similar stage of
construction or, where applicable, date on which work for a
conversion or an alteration or modification of a major
character was commenced

* Delete as appropriate.

¹ Alternatively, the particulars of the ship may be placed horizontally in boxes.

THIS IS TO CERTIFY:

1. That the ship has been surveyed in accordance with the requirements of regulation VIII/9 of the Convention.
2. That the ship, being a nuclear ship, complied with all the requirements of chapter VIII of the convention and conformed to the Safety Assessment approved for the ship; and that:
 - 2.2 the ship complied with the requirements of the Convention as regards:
 - .1 the structure, main and auxiliary machinery, boilers and other pressure vessels, including the nuclear propulsion plant and the collision protective structure;
 - .2 the watertight subdivision arrangements and details;
 - .3 the following subdivision load lines;

Subdivision load lines assigned and marked on the ship's side at amidships (regulations II-1/18 ²)	Freeboard	To apply when the spaces in which passengers are carried include the following alternative spaces
P.1
P.2
P.3

- 2.2 the ship complied with the requirements of the Convention as regards structural fire protection, fire safety systems and appliances and fire control plans;
- 2.3 the ship complied with the requirements of the Convention as regards radiation protection systems and equipment;
- 2.4 the life-saving appliances and the equipment of the lifeboats, life rafts and rescue boats were provided in accordance with the requirements of the Convention;
- 2.5 the ship was provided with a line-throwing appliance and radio installations used in life-saving appliances in accordance with the requirements of the Convention;

² For ships constructed before 1 January 2009, the applicable subdivision notation “C.1, C.2 and C.3” should be used.

- 2.6 the ship complied with the requirements of the Convention as regards radio installations;
- 2.7 the functioning of the radio installation used in life-saving appliances complied with the requirements of the Convention;
- 2.8 the ship complied with the requirements of the Convention as regards shipborne navigational equipment, means of embarkation for pilots and nautical publications;
- 2.9 the ship was provided with lights, shapes, means of making sound signals and distress signals, in accordance with the requirements of the Convention and the International Regulations for Preventing Collisions at Sea in force;
- 2.10. in all other respects the ship complied with the relevant requirements of the Convention.
- 2.11. the ship was/was not¹ subjected to an alternative design and arrangements in pursuance of regulation II-2/17 of the Convention
- 2.12 a Document of approval of alternative design and arrangements for fire safety is/is not¹ appended to this Certificate

This certificate is valid until

Completion date of the survey on which this certificate is based

 (dd/mm/yyyy)

Issued at
 (Place of issue of certificate)

.....
 (Date of issue)

.....
 (Signature of authorized official issuing the certificate)

(Seal or stamp of the issuing authority, as appropriate)

¹ Delete as appropriate.



*RECORD OF EQUIPMENT FOR THE
NUCLEAR PASSENGER SHIP SAFETY CERTIFICATE (Form PNUC)*

This Record shall be permanently attached to the
Nuclear Passenger Ship Safety Certificate

**RECORD OF EQUIPMENT FOR COMPLIANCE
WITH THE INTERNATIONAL CONVENTION
FOR THE SAFETY OF LIFE AT SEA, 1974
as modified by the Protocol of 1988 relating thereto**

1 Particulars of ship

Name of ship

Distinctive number or letters

Number of passengers for which
certified

Minimum number of persons with
required qualifications to operate the
radio installations

2 Details of life-saving appliances

1 Total number of persons for which life-saving appliances are provided		
	Port side	Starboard side
2 Total numbers of lifeboats
2.1 Total numbers of persons accommodated by them
2.2 Number of partially enclosed lifeboats (regulation III/2 1 and LSA Code, section 4.5)
2.3 Number of totally enclosed lifeboats (regulation III/2 1 and LSA Code, section 4.6)
2.4 Other lifeboats
2.4.1 Number
2.5.2 Type

2 Details of life-saving appliances (continued)

3	Number of motor lifeboats included in the total lifeboats shown above
3.1	Number of lifeboats fitted with searchlights
4.	Number of rescue boats
4.1	Number of boats which are included in the total lifeboats shown above
5	Liferafts
5.1	Those for which approved launching appliances are required
5.1.1	Number of liferafts
5.1.2	Number of persons accommodated by them
5.2	Those for which approved launching appliances are not required
5.2.1	Number of liferafts
5.2.2	Number of persons accommodated by them
6	Buoyant apparatus
6.1	Number of apparatus
6.2	Number of persons capable of being supported
7	Number of lifebuoys
8	Number of lifejackets
9	Immersion suits
9.1	Total number
9.2	Number of suits complying with the requirements for lifejackets
10	Number of thermal protective aids ¹
11	Radio installations used in life-saving appliances
11.1	Number of search and rescue locating devices
11.1.1	Radar search and rescue transponders (SART)
11.1.2	AIS search and rescue transmitters (AIS-SART)
11.2	Number of two-way VHF radiotelephone apparatus

¹ Excluding those required by LSA Code paragraphs 4.1.5.1.24, 4.4.8.31 and 5.1.2.2.13.

3 Details of radio facilities

Item	Actual provision
1 Primary systems
1.1 VHF radio installation
1.1.1 DSC encoder
1.1.2 DSC watch receiver
1.1.3 Radiotelephony
1.2 MF radio installation
1.2.1 DSC encoder
1.2.2 DSC watch receiver
1.2.3 Radiotelephony
1.3 MF/HF radio installation
1.3.1 DSC encoder
1.3.2 DSC watch receiver
1.3.3 Radiotelephony
1.3.4 Direct-printing radiotelegraphy
1.4 INMARSAT ship earth station
2 Secondary means of alerting
3 Facilities for reception of maritime safety information
3.1 NAVTEX receiver
3.2 EGC receiver
3.3 HF direct-printing radiotelegraph receiver
4 Satellite EPIRB
4.1 COSPASS-SARSAT
4.2 INMARSAT
5 VHF EPIRB
6 Ship's search and rescue locating device
6.1 Radar search and rescue transponder (SART)
6.2 AIS search and rescue transmitter (AIS-SART)

4 *Methods used to ensure availability of radio facilities* (regulations IV/15.6 and 15.7)

- 4.1 Duplication of equipment
- 4.2 Shore-based maintenance
- 4.3 At-sea maintenance capability

5 *Details of navigational systems and equipment*

Item	Actual provision
1.1 Standard magnetic compass ¹
1.2 Spare magnetic compass ¹
1.3 Gyro-compass ¹
1.4 Gyro-compass heading repeater ¹
1.5 Gyro-compass bearing repeater ¹
1.6 Heading or track control system ¹
1.7 Pelorus or compass bearing device ¹
1.8 Means of correcting heading and bearings
1.9 Transmitting heading device (THD) ¹
2.1 Nautical charts/Electronic chart display and information system (ECDIS) ^{2, 1}
2.2 Back-up arrangements for ECDIS
2.3 Nautical publications
2.4 Back-up arrangements for electronic nautical publications
3.1 Receiver for a global navigation satellite system/terrestrial radionavigation system ^{2, 1}
3.2 9 GHz radar ¹
3.3 Second radar (3 GHz/9 GHz ²) ¹
3.4 Automatic radar plotting aid (ARPA) ¹
3.5 Automatic tracking aid
3.6 Second automatic tracking aid
3.7 Electronic plotting aid ¹
4 Automatic identification system (AIS)

¹ Alternative means of meeting this requirement are permitted under regulation V/19. In case of other means they shall be specified.

² Delete as appropriate.

5 Details of navigational systems and equipment (continued)

Item	Actual provision
5 Voyage data recorder (VDR)
6.1 Speed and distance measuring device (through the water) ¹
6.2 Speed and distance measuring device (over the ground in the forward and athwartship direction) ¹
7 Echo-sounding device ¹
8.1 Rudder, propeller, thrust, pitch and operational mode indicator ¹
8.2 Rate-of-turn indicator ¹
9 Sound reception system ¹
10 Telephone to emergency steering position ¹
11 Daylight signaling lamp ¹
12 Radar reflector ¹
13 International Code of Signals
14 IAMSAR Manual, Volume III
15 Bridge navigational watch alarm system (BNWAS)

THIS IS TO CERTIFY that this Record is correct in all respects

Issued at

.....
(Place of issue of the Record)

.....
(Date of issue)

.....
(Signature of authorized official issuing the Record)

(Seal or stamp of the issuing authority, as appropriate)

¹ Alternative means of meeting this requirement are permitted under regulation V/19. In case of other means they shall be specified.



NUCLEAR CARGO SHIP SAFETY CERTIFICATE

This certificate shall be supplemented by a Record of Equipment (Form CNUC)

Issued under the provisions of the
INTERNATIONAL CONVENTION FOR THE SAFETY OF LIFE AT SEA,
1974,
as modified by the Protocol of 1988 relating thereto

under the authority of the Government of

The Kingdom of Denmark

by

DANISH MARITIME AUTHORITY

Particulars of ship

Name of ship

Distinctive number or letters

Port of registry

Gross tonnage

Deadweight of ship (metric tons)¹

Length of ship (regulation III/3.12)

Sea areas in which ship is certified to
operate (regulation IV/2)

IMO Number

Type of ship²

Bulk carrier

Oil tanker

Chemical tanker

Gas carrier

Cargo ship other than any of the above

Date on which keel was laid or ship was at a similar stage of
construction or, where applicable, date on which work for an
alteration or modification of a major character was commenced

¹ For oil tankers, chemical tankers and gas carriers only.

² Delete as appropriate.

THIS IS TO CERTIFY:

1. That the ship has been surveyed in accordance with the requirements of regulation VIII/9 of the Convention.
2. That the ship, being a nuclear ship, complied with all the requirements of chapter VIII of the Convention and conformed to the safety Assessment approved for the ship; and that:
 - 2.1 the condition of the structure, machinery and equipment as defined in regulation I/10 (as applicable to comply with regulation VIII/9), including the nuclear propulsion plant and the collision protective structure, was satisfactory and the ship complied with the relevant requirements of chapter II-1 and chapter II-2 of the Convention (other than those relating to fire safety systems and appliances and fire control plans);
 - 2.2 the ship complied with the requirements of the Convention as regards fire safety systems and appliances and fire control plans;
 - 2.3 the life-saving appliances and the equipment of the lifeboats, liferafts and rescue boats were provided in accordance with the requirements of the Convention;
 - 2.4 the ship was provided with a line-throwing appliance and radio installations used in life-saving appliances in accordance with the requirements of the Convention;
 - 2.5 the ship complied with the requirements of the Convention as regards radio installations;
 - 2.6 the functioning of the radio installation used in life-saving appliances complied with the requirements of the Convention;
 - 2.7 the ship complied with the requirements of the Convention as regards shipborne navigational equipment, means of embarkation for pilots and nautical publications;
 - 2.8 the ship was provided with lights, shapes, means of making sound signals and distress signals, in accordance with the requirements of the Convention and the International Regulations for Preventing Collisions at Sea in force;
 - 2.9 in all other respects the ship complied with the relevant requirements of the regulations, so far as these apply thereto.
 - 2.10 the ship was/was not¹ subjected to an alternative design and arrangements in pursuance of regulation II-2/17 of the Convention;
 - 2.11 a Document of approval of alternative design and arrangements for fire safety is/is not³ appended to this Certificate.

¹ Delete as appropriate.

This certificate is valid until

Completion date of the survey on
which this certificate is based

(dd/mm/yyyy)

Issued at

(Place of issue of certificate)

.....
(Date of issue)

.....
(Signature of authorized official issuing the certificate)

(Seal or stamp of the issuing authority, as appropriate)

*RECORD OF EQUIPMENT FOR THE
CARGO SHIP SAFETY CERTIFICATE (Form CNUC)*

This Record shall be permanently attached to the
Nuclear Cargo Ship Safety Certificate

**RECORD OF EQUIPMENT FOR COMPLIANCE
WITH THE INTERNATIONAL CONVENTION
FOR THE SAFETY OF LIFE AT SEA, 1974
as modified by the Protocol of 1988 relating thereto**

1 Particulars of ship

Name of ship

Distinctive number or letters

Minimum number of persons with required
qualifications to operate the radio installations

2 Details of life-saving appliances

1	Total number of persons for which life-saving appliances are provided	
		Port side	Starboard side
2	Total numbers of lifeboats
2.1	Total numbers of persons accommodated by them
2.2	Number of totally enclosed lifeboats (regulation III/3 1 and LSA Code section 4.6)
2.3	Number of lifeboats with a self contained air support system (regulation III/3 1 and LSA Code section 4.8)
2.4	Number of fire-protected lifeboats (regulation III/3 1 and LSA Code section 4.9)
2.5	Other lifeboats
2.5.1	Number
2.5.2	Type
2.6	Number of free-fall lifeboats
2.6.1	Totally enclosed (regulation III/3 1 and LSA Code section 4.7)
2.6.2	Self-contained (regulation III/3 1 and LSA Code section 4.8)
2.6.3	Fire-protected (regulation II/31 and LSA Code section 4.9)

3 *Details of radio facilities*

Item	Actual provision
1 Primary systems
1.1 VHF radio installation
1.1.1 DSC encoder
1.1.2 DSC watch receiver
1.1.3 Radiotelephony
1.2 MF radio installation
1.2.1 DSC encoder
1.2.2 DSC watch receiver
1.2.3 Radiotelephony
1.3 MF/HF radio installation
1.3.1 DSC encoder
1.3.2 DSC watch receiver
1.3.3 Radiotelephony
1.3.4 Direct-printing radiotelegraphy
1.4 INMARSAT ship earth station
2 Secondary means of alerting
3 Facilities for reception of maritime safety information
3.1 NAVTEX receiver
3.2 EGC receiver
3.3 HF direct-printing radiotelegraph receiver
4 Satellite EPIRB
4.1 COSPASS-SARSAT
4.2 INMARSAT
5 VHF EPIRB
6 Ship's search and rescue locating device
6.1 Radar search and rescue transponder (SART)
6.2 AIS search and rescue transmitter (AIS-SART)

4 *Methods used to ensure availability of radio facilities (regulations IV/15.6 and 15.7)*

4.1 Duplication of equipment
4.2 Shore based maintenance
4.3 At-sea maintenance capability

5 Details of navigational systems and equipment

Item	Actual provision
1.1 Standard magnetic compass ¹
1.2 Spare magnetic compass ¹
1.3 Gyro-compass ¹
1.4 Gyro-compass heading repeater ¹
1.5 Gyro-compass bearing repeater ¹
1.6 Heading or track control system ¹
1.7 Pelorus or compass bearing device ¹
1.8 Means of correcting heading and bearings
1.9 Transmitting heading device (THD) ¹
2.1 Nautical charts/Electronic chart display and information system (ECDIS) ^{2, 1}
2.2 Back-up arrangements for ECDIS
2.3 Nautical publications
2.4 Back-up arrangements for electronic nautical publications
3.1 Receiver for a global navigation satellite system/terrestrial radionavigation system ^{2, 1}
3.2 9 GHz radar ¹
3.3 Second radar (3 GHz/9 GHz ²) ¹
3.4 Automatic radar plotting aid (ARPA) ¹
3.5 Automatic tracking aid
3.6 Second automatic tracking aid
3.7 Electronic plotting aid ¹
4 Automatic identification system (AIS)
5 Voyage data recorder (VDR)
6.1 Speed and distance measuring device (through the water) ¹
6.2 Speed and distance measuring device (over the ground in the forward and athwartship direction) ¹
6.3 Echo-sounding device ¹

¹ Alternative means of meeting this requirement are permitted under regulation V/19. In case of other means they shall be specified.

² Delete as appropriate.

5 Details of navigational systems and equipment (continued)

Item	Actual provision
7.1 Rudder, propeller, thrust, pitch and operational mode indicator ¹
7.2 Rate-of-turn indicator ¹
8 Sound reception system ¹
9 Telephone to emergency steering position ¹
10 Daylight signaling lamp ¹
11 Radar reflector ¹
12 International Code of Signals
13 IAMSAR Manual Volume III
14 Bridge navigational watch alarm system (BNWAS)

THIS IS TO CERTIFY that this Record is correct in all respects

Issued at

.....
(Place of issue of the record)

.....
(Date of issue)

.....
(Signature of duly authorized official issuing the record)

(Seal or stamp of the issuing authority, as appropriate)

¹ Alternative means of meeting this requirement are permitted under regulation V/19. In case of other means they shall be specified.



Supplement to the International Oil Pollution Prevention Certificate
(IOPP Certificate)

**RECORD OF CONSTRUCTION AND
EQUIPMENT FOR SHIPS OTHER THAN
OIL TANKERS**

in respect of the provisions of Annex I of the
INTERNATIONAL CONVENTION FOR THE PREVENTION OF
POLLUTION FROM SHIPS, 1973,
as modified by the Protocol of 1978 relating thereto
(hereinafter referred to as »the Convention«)

Notes:

1. This form is to be used for the third type of ships as categorized in the IOOP Certificate, i.e. »ships other than any of the above«. For oil tankers and ships other than oil tankers with cargo tanks coming under regulation 2.2 of Annex I of the Convention, Form B shall be used.
2. This Record shall be permanently attached to the IOPP Certificate. The IOPP Certificate shall be available on board the ship at all times.
3. The language of the original Record shall be at least in English, French or Spanish. If an official language of the issuing country is also used, this shall prevail in case of a dispute or discrepancy.
4. Entries in boxes shall be made by inserting either a cross (X) for the answer »yes« and »applicable« or a dash (-) for the answers »no« and »not applicable« as appropriate.
5. Regulations mentioned in this Record refer to regulations of Annex I of the Convention and resolutions refer to those adopted by the International Maritime Organization.

1. Particulars of ship

- 1.1 Name of ship
- 1.2 Distinctive number or letters
- 1.3 Port of registry
- 1.4 Gross tonnage
- 1.5 Date of build:
- 1.5.1 Date of building contract
- 1.5.2 Date on which keel was laid or ship was at a similar stage of construction
- 1.5.3 Date of delivery

- 1.6 Major conversion (if applicable):
- 1.6.1 Date of conversion contract
- 1.6.2 Date on which conversion was commenced
- 1.6.3 Date of completion of conversion
- 1.7. The ship has been accepted by the Administration as a »ship delivered on or before 31 December 1979« under regulation 1.28.1 due to unforeseen delay in delivery

2. Equipment for the control of oil discharge from machinery space bilges and oil fuel tanks (regulations 16 and 14)

- 2.1 Carriage of ballast water in oil fuel tanks:
- 2.1.1 The ship may under normal conditions carry ballast water in oil fuel tanks

.2 Type of filtering equipment fitted:

- 2.2.1 Oil filtering (15 ppm) equipment (regulation 14.6)
- 2.2.2 Oil filtering (15 ppm) equipment with alarm and automatic stopping device (regulation 14.7)

.3 Approval standards:*

- 2.3.1 The separating/filtering system:
- .1 has been approved in accordance with the resolution A.393(X)
- .2 has been approved in accordance with resolution MEPC.60(33)
- .3 has been approved in accordance with resolution A.107(49)
- .4 has been approved in accordance with A.233(VII)
- .5 has been approved in accordance with national standards not based upon resolution A.393(X) or A.233(VII)
- .6 has not been approved
- 2.3.2 The process unit has been approved in accordance with resolution A.444(XI)
- 2.3.3 The oil content meter:
- .1 has been approved in accordance with resolution A.393(X);
- .2 has been approved in accordance with resolution MEPC.60(33).
- .3 has been approved in accordance with resolution MEPC.107(49).

.....

* Refer to the Recommendation on international performance and test specifications of oily-water separating equipment and oil content meters adopted by the Organization on 14 November 1977 by resolution A.393(X), which superseded resolution A.233(VII). Further reference is made to the Guidelines and specifications for pollution prevention equipment for machinery space bilges adopted by the Marine Environment Protection Committee of the Organization by resolution MEPC.60(33), which, effective on 6 July 1993, superseded resolutions A.393(X) and A.444(XI); and to the revised Guidelines and specifications for pollution prevention equipment for machinery spaces of ships adopted by the Marine Environment Protection Committee of the Organization by resolution MEPC.107(49) which, effective on 1 January 2005, superseded resolutions MEPC.60(33), A.393(X) and A.444(XI).

- 2.4 Maximum throughput of the system is m³/h
- 2.5 Waiver of regulation 14:
- 2.5.1 The requirements of regulation 14.1 or 14.2 are waived in respect of the ship in accordance with regulation 14.5.
- 2.5.1.1 The ship is engaged exclusively on voyages within special area(s):
- 2.5.1.2 The ship is certified under the International Code of Safety for High-Speed Craft and engaged on a scheduled service with a turn-around time not exceeding 24 hours
- 2.5.2 The ship is fitted with holding tank(s) for the total retention on board of all oily bilge water as follows:

Tank identification	Tank Location		Volume (m ³)
	Frames (from) – (to)	Lateral Position	
Total volume:			m ³

- 2.A.1. The ship is required to be constructed according to regulation 12A and complies with the requirements of:
- paragraphs 6 and either 7 or 8 (double hull construction)
- paragraph 11 (accidental oil fuel outflow performance)
- 2.A.2 The ship is not required to comply with the requirements of regulation 12A

3. Means for retention and disposal of oil residues (sludge)(regulation 12) and bilge water holding tank(s)*

3.1 The ship is provided with oil residue (sludge) tanks as follows:

Tank identification	Tank Location		Volume (m ³)
	Frames (from) – (to)	Lateral Position	
Total volume:			m ³

- 3.2 Means for the disposal of residues (sludge) retained in oil residue (sludge) tanks: kW or kcal/h (delete as appropriate)
- 3.2.1 Incinerator for oil residues (sludge), maximum capacity
- 3.2.2 Auxiliary boiler suitable for burning oil residues (sludge)
- 3.2.3 Other acceptable means, state which:

* Bilge water holding tank(s) are not required by the Convention; if such tank(s) are provided they shall be listed in table 3.3.

3.3 The ship is fitted with holding tank(s) for the retention on board of oily bilge water as follows:

Tank identification	Tank Location		Volume (m ³)
	Frames (from) – (to)	Lateral Position	
Total volume:		 m ³

4. Standard discharge connection (regulation 13)

4.1 The ship is provided with a pipeline for the discharge of residues from machinery bilges to reception facilities, fitted with a standard discharge connection in compliance with regulation 13

5. Shipboard oil pollution emergency plan (regulation 37)

5.1 The ship is provided with a shipboard oil pollution emergency plan in accordance with regulation 37

5.2 The ship is provided with a shipboard oil pollution emergency plan in accordance with regulation 37.3

6. Exemption

6.1 Exemption has been granted by the Administration from the requirements of chapters 3 of Annex I of the Convention in accordance with regulation 3.1 on those items listed paragraph(s)

.....
 of this Record

7. Equivalents (regulation 5)

7.1 Equivalents have been approved by the Administration for certain requirements of Annex I on those items listed under paragraph(s)

.....
 of this Record

THIS IS TO CERTIFY that this Record is correct in all respects.

Issued at
 (Place of issue of the Record)

..... (Date of issue) (Signature of duly authorized officer issuing the Record)

(Seal or stamp of issuing authority, as appropriate)



Supplement to the International Oil Pollution Prevention Certificate
(IOPP Certificate)

RECORD OF CONSTRUCTION AND EQUIPMENT FOR OIL TANKERS

in respect of the provisions of Annex I of the
INTERNATIONAL CONVENTION FOR THE PREVENTION OF
POLLUTION FROM SHIPS, 1973,
as modified by the Protocol of 1978 relating thereto
(hereinafter referred to as »the Convention«)

Notes:

1. This form is to be used for the first two types of ships as categorized in the IOOP Certificate, i.e. »oil tankers« and »ships other than oil tankers with cargo tanks coming under regulation 2.2 of Annex I of the Convention«. For the third type of ships as categorized in the IOPP Certificate, Form A shall be used.
2. This Record shall be permanently attached to the IOPP Certificate. The IOPP Certificate shall be available on board the ship at all times.
3. The language of the original Record shall be at least in English, French or Spanish. If an official language of the issuing country is also used, this shall prevail in case of a dispute or discrepancy.
4. Entries in boxes shall be made by inserting either a cross (X) for the answer »yes« and »applicable« or a dash (-) for the answers »no« and »not applicable« as appropriate.
5. Unless otherwise stated, regulations mentioned in the Record refer to regulations of Annex I of the Convention and resolutions refer to those adopted by the International Maritime Organization.

1. Particulars of ship

- | | | |
|-----|-------------------------------|----------------------------------|
| 1.1 | Name of ship | |
| 1.2 | Distinctive number or letters | |
| 1.3 | Port of registry | |
| 1.4 | Gross tonnage | |
| 1.5 | Carrying capacity of ship | (m ³) |
| 1.6 | Deadweight of ship | (tonnes) (regulation 1.23) |
| 1.7 | Length of ship | (m) (regulation 1.19) |

- 1.8 Date of build:
- 1.8.1 Date of building contract
- 1.8.2 Date on which keel was laid or ship was
at a similar stage of construction
- 1.8.3 Date of delivery
- 1.9 Major conversion (if applicable):
- 1.9.1 Date of conversion contract
- 1.9.2 Date on which conversion was
commenced
- 1.9.3 Date of completion of conversion
- 1.10 Unforeseen delay in delivery:
- 1.10.1 The ship has been accepted by the Administration as a » ship delivered on or before 31
December 1979« under regulation 1.28.1 due to unforeseen delay in delivery
- 1.10.2 The ship has been accepted by the administration as an »oil tanker delivered on or
before 1 June 1982« under regulation 1.28.3 due to unforeseen delay in delivery
- 1.10.3 The ship is not required to comply with the provisions of regulation 26 due to
unforeseen delay in delivery
- 1.11 Type of ship:
- 1.11.1 Crude oil tanker
- 1.11.2 Product carrier
- 1.11.3 Product carrier not carrying fuel oil or heavy diesel oil referred to in regulation 20.2, or
lubricating oil
- 1.11.4 Crude oil/product carrier
- 1.11.5 Combination carrier
- 1.11.6 Ship, other than an oil tanker, with cargo tanks coming under regulation 2.2 of
Annex I of the Convention
- 1.11.7 Oil tanker dedicated to carriage of product referred to in regulation 2.4
- 1.11.8 The ship, being designated as a »crude oil tanker« operating with COW, is also
designated as a »product carrier« operating with CBT, for which a separate IOPP
Certificate has also been issued
- 1.11.9 The ship, being designated as a »product carrier« operating with CBT, is also designated
as a »crude oil tanker« operating with COW, for which a separate IOPP Certificate has
also been issued

2. Equipment for the control of oil discharge from machinery space bilges and oil fuel tanks (regulations 16 and 14)

2.1 Carriage of ballast water in oil fuel tanks:

2.1.1 The ship may under normal conditions carry ballast water in oil fuel tanks

2.2 Type of filtering equipment fitted:

2.2.1 Oil filtering (15 ppm) equipment (regulation 14.6)

2.2.2 Oil filtering (15 ppm) equipment with alarm and automatic stopping device (regulation 14.7)

2.3 Approval standards*:

2.3.1 The separating/filtering system:

.1 has been approved in accordance with resolution A.393(X)

.2 has been approved in accordance with resolution MEPC.60(33)

.3 has been approved in accordance with resolution MEPC.107(49)

.4 has been approved in accordance with A.233(VII)

.5 has been approved in accordance with national standards not based upon resolution A.393(X) or A.233(VII)

.6 has not been approved

2.3.2 The process unit has been approved in accordance with resolution A.444(XI)

2.3.3 The oil content meter:

.1 has been approved in accordance with resolution A.393(X);

.2 has been approved in accordance with resolution MEPC.60(33).

.3 has been approved in accordance with resolution MEPC.107(49).

2.4 Maximum throughput of the system is m³/h

2.5 Waiver of regulation 14:

2.5.1 The requirements of regulation 14.1 or 14.2 are waived in respect of the ship in accordance with regulation 14.5.

The ship is engaged exclusively on voyages within special area(s):

* Refer to the Recommendation on the international performance and test specifications of oily water separation equipment and oil content meters adopted by the Organization on 14 November 1997 by resolution A.393(X), which superseded resolution A.233(VII). Further reference is made to the Guidelines and specifications for pollution prevention equipment for machinery space bilges adopted by the Marine Environment Protection Committee of the Organization by resolution MEPC.60(33), which, effective on 6 July 1993, superseded resolutions A.393(X) and A.393(XI); and to the revised Guidelines and specifications for pollution prevention equipment for machinery spaces of ships adopted by the Marine Environment Protection Committee of the Organization by resolution MEPC.107(49) which, effective on 1 January 2005, superseded resolutions MEPC.60(33), A.393(X) and A.444(XI)

2.5.2 The ship is fitted with holding tank(s) for the total retention on board of all oily bilge water as follows:

Tank identification	Tank Location		Volume (m ³)
	Frames (from) – (to)	Lateral Position	
Total volume:		 m ³

2.5.3 In lieu of holding tank the ship is provided with arrangements to transfer bilge water to the slop tank.

2.A.1. The ship is required to be constructed according to regulation 12A and complies with the requirements of:
 paragraphs 6 and either 7 or 8 (double hull construction)
 paragraph 11 (accidental oil fuel outflow performance)

2.A.2 The ship is not required to comply with the requirements of regulation 12A

3. Means for retention and disposal of oil residues (sludge)(regulation 12) and bilge water holding tank(s)*

3.1 The ship is provided with oil residue (sludge) tanks for retention of oil residues (sludge) on board as follows:

Tank identification	Tank Location		Volume (m ³)
	Frames (from) – (to)	Lateral Position	
Total volume:		 m ³

3.2 Means for the disposal of oil residues (sludge) retained in oil residue (sludge) tanks: kW or kcal/h (delete as appropriate)

3.2.1 Incinerator for oil residues (sludge), maximum capacity

3.2.2 Auxiliary boiler suitable for burning oil residues (sludge)

3.2.4 Other acceptable means, state which:

* Bilge water holding tank(s) are not required by the Convention; if such tank(s) are provided they shall be listed in Table 3.3.

3.3 The ship is fitted with holding tank(s) for the retention on board of oily bilge water as follows:

Tank identification	Tank Location		Volume (m ³)
	Frames (from) – (to)	Lateral Position	
Total volume:		 m ³

4. Standard discharge connection (regulation 13)

4.1 The ship is provided with a pipeline for the discharge of residues from machinery bilges to reception facilities, fitted with a standard discharge connection in compliance with regulation 13

5. Construction (regulations 18, 19, 20, 23, 26, 27 and 28)

- 5.1 In accordance with the requirements of regulation 18, the ship is:
- 5.1.1 required to be provided with SBT, PL an COW
 - 5.1.2 required to be provided with SBT and PL
 - 5.1.3 required to be provided with SBT
 - 5.1.4 required to be provided with SBT and COW
 - 5.1.5 required to be provided with SBT and CBT
 - 5.1.6 not required to comply with the requirements of regulation 18
- 5.2 Segregated ballast tanks (SBT):
- 5.2.1 The ship is provided with SBT, in compliance with regulation 18
 - 5.2.2 The ship is provided with SBT, in compliance with regulation 18, which are arranged in protective locations (PL) in compliance with regulation 18.12 to 18.15
 - 5.2.3 SBT are distributed as follows:

Tank	Volume (m ³)	Tank	Volume (m ³)

Total volume: m³

5.3 Dedicated clean ballast tanks (CBT):

5.3.1 The ship is provided with CBT in compliance with regulation 18.8, and may operate as a product carrier

5.3.2 CBT are distributed as follows:

Tank	Volume (m ³)	Tank	Volume (m ³)

Total volume: m³

5.3.3 The ship has been supplied with a valid Dedicated Clean Ballast Tank Operation Manual, which is dated

5.3.4 The ship has common piping and pumping arrangements for ballasting the CBT and handling cargo oil

5.3.5 The ship has separate independent piping and pumping arrangements for ballasting the CBT

5.4 Crude oil washing (COW):

5.4.1 The ship is equipped with a COW system in compliance with regulation 33

5.4.2 The ship is equipped with a COW system in compliance with regulation 33 except that the effectiveness of the system has not been confirmed in accordance with regulation 33.1 and paragraph 4.2.10 of the Revised COW Specifications (resolution A.446(XI) as amended by resolution A.497(XII) and A.897(21))

5.4.3 The ship has been supplied with a valid Crude Oil Washing Operation and Equipment Manual, which is dated

5.4.4 The ship is not required to be but is equipped with COW in compliance with the safety aspects of the Revised COW Specifications (resolution A.446(XI) as amended by resolution A.497(XII) and A.897(21))

5.5 Exemption from regulation 18:

5.5.1 The ship is solely engaged in trade between

.....
in accordance with regulation 2.5 and is therefore exempted from the requirements of regulation 18

5.5.2 The ship is operating with special ballast arrangements in accordance with regulation 18.10 and is therefore exempted from the requirements of regulation 18

5.6 Limitation of size and arrangements of cargo tanks (regulation 26):

5.6.1 The ship is required to be constructed according to, and complies with, the requirements of regulation 26

5.6.2 The ship is required to be constructed according to, and complies with, the requirements of regulation 26.4 (see regulation 2.2)

5.7 Subdivision and Stability (regulation 28)

5.7.1 The ship is required to be constructed according to, and complies with, the requirements of regulation 28

5.7.2 Information and data required under regulation 28.5 have been supplied to the ship in an approved form

5.7.3 The ship is required to be constructed according to, and complies with the requirements of, regulation 27

5.7.4 Information and data required under regulation 27 for combination carriers have been supplied to the ship in written procedure approved by the Administration

5.8 Double hull construction:

5.8.1 The ship is required to be constructed according to regulation 19 and complies with the requirements of:

.1 paragraph (3) (double-hull construction)

.2 paragraph (4) (mid-height deck tankers with double side construction)

.3 paragraph (5) (alternative method approved by the Marine Environment Protection Committee)

5.8.2 The ship is required to be constructed according to and complies with the requirements of regulation 19.6 (double bottom requirements)

5.8.3 The ship is not required to comply with the requirements of regulation 19

5.8.4 The ship is subject to regulation 20 and:

.1 is required to comply with paragraphs 2 to 5, 7 and 8 of regulation 19 and regulation 28 in respect of paragraph 28.6 not later than

.2 is allowed to continue operation in accordance with regulation 20.5 until:

.3 is allowed to continue operation in accordance with regulation 20.7 until:

- 5.8.5 The ship is not subject to regulation 20 (check which box(es) apply):
- .1 The ship is less than 5,000 tonnes deadweight
 - .2 The ship complies with regulation 20.1.2
 - .3 The ship complies with regulation 20.1.3
- 5.8.6 The ship is subject to regulation 21 and:
- .1 is required to comply with regulation 21.4 not later than
 - .2 is allowed to continue operation in accordance with regulation 21.5 until:
 - .3 is allowed to continue operation in accordance with regulation 21.6.1 until:
 - .4 is allowed to continue operation in accordance with regulation 21.6.2 until:
 - .5 is exempted from the provisions of regulation 21 accordance with regulation 21.7.2 until:
- 5.8.7 The ship is not subject to regulation 21
- .1 The ship is less than 600 tonnes deadweight
 - .2 The ship complies with regulation 19 (Deadweight tonnes \geq 5,000)
 - .3 The ship complies with regulation 21.1.2.
 - .4 The ship complies with regulation 21.4.2 (600 \leq Deadweight tonnes \leq 5,000)
 - .3 The ship does not carry "heavy grade oil" as defined in regulation 21.2 of MARPOL Annex I
- 5.8.8 The ship is not subject to regulation 22 and:
- .1 complies with the requirements of regulation 22.2
 - .2 complies with the requirements of regulation 22.3
 - .3 complies with the requirements of regulation 22.5
- 5.8.9 The ship is not subject to regulation 22
- 5.9 Accidental outflow performance:
- 5.9.1 The ship complies with the requirements of regulation 23

6. Retention of oil on board (regulations 29, 31 and 32)

- 6.1 Oil discharge monitoring and control system:
- 6.1.1 The ship comes under the category

- oil tanker as defined in resolution A.496(XII) or A.586(14)*
- 6.1.2 Type oil discharge monitoring and control system has been approved in accordance with resolution MEPC.108(49)[†]
- 6.1.3 Type system comprises:
- .1 control unit
 - .2 computing unit
 - .3 calculating unit
- 6.1.4 Type system is
- .1 fitted with a starting interlock
 - .2 fitted with automatic stopping device
- 6.1.5 The oil content meter is approved under the terms of resolution A.393(X) or A.586(14)* or MEPC.108(49) (*delete as appropriate*) suitable for:
- .1 crude oil
 - .2 black products
 - .3 white products
- 6.1.6 The ship has been supplied with an operations manual for the oil discharge monitoring and control system
- 6.2 Slop tanks:
- 6.2.1 The ship is provided with _____ dedicated slop tank(s) with the total capacity of _____ m³, which is _____ % of the oil carrying capacity, in accordance with:
- .1 regulation 29.2.3
 - .2 regulation 29.2.3.1
 - .3 regulation 29.2.3.2
 - .4 regulation 29.2.3.3
- 6.2.2 Cargo tanks have been designated as slop tanks
- 6.3 Oil/water interface detectors:

* For oil content meters installed on tankers built prior to 2 October 1986, refer to the Recommendation on international performance and test specifications for oily-water separating equipment and oil content meters adopted by the Organization by resolution A.393(X). For oil content meters as part of discharge monitoring and control systems installed on tankers built on or after 2 October 1986, refer to the Guidelines and specifications for oil discharge monitoring and control systems for oil tankers adopted by the Organization by resolution A.586(14). For oil content meters as part of discharge monitoring and control systems installed on tankers the keel of which are laid or are in a similar stage of construction on or after 1 January 2005, refer to the revised Guidelines and specifications for oil discharge monitoring and control systems for oil tankers adopted by the Organization by resolution MEPC.108(49).

[†] Oil tankers the keels of which are laid, or which are at a similar stage of construction, on or after 1 January 2005 should be fitted with a system approved under resolution MEPC.108(49).

6.3.1 The ship is provided with oil/water interface detectors approved under the terms of resolution MEPC.5(XIII)*

6.4 Exemptions from regulations 29, 31 and 32:

6.4.1 The ship is exempted from the requirements of regulations 2,9 31 and 32 in accordance with regulation 2.4

6.4.2 The ship is exempted from the requirements of regulations 29, 31 and 32 in accordance with regulation 2.2

6.5 Waiver of regulation :

6.5.1 The requirements of regulation 31 and 32 are waived in respect of the ship in accordance with regulation 3.5. The ship is engaged exclusively on:

.1 specific trade under regulation 2.5:

.....
.....

.2 voyages within special area(s):

.....
.....

.3 voyages within 50 miles of the nearest land outside special area(s) of 72 hours or less in duration restricted to:

.....
.....

7. Pumping, piping and discharge arrangements (regulation 30)

7.1 The overboard discharge outlets for segregated ballast are located:

7.1.1 Above the waterline

7.1.2 Below the waterline

7.2 The overboard discharge outlets, other than the discharge manifold, for clean ballast are located:*

* Refer to the Specification for oil/water interface detector adopted by Marine Environment Protection Committee of the Organization by resolution MEPC.5(XIII).

* Only those outlets which can be monitored are to be indicated.

- 7.2.1 Above the waterline
- 7.2.2 Below the waterline
- 7.3 The overboard discharge outlets, other than the discharge manifold, for dirty ballast water or oil-contaminated water from cargo tank area are located*
 - 7.3.1 Above waterline
 - 7.3.2 Below waterline in conjunction with the part flow arrangements in compliance with regulation 30.6.5
 - 7.3.3 Below the waterline
- 7.4 Discharge of oil from cargo pumps and oil lines (regulations 30.4 and 30.5):
 - 7.4.1 Means to drain all cargo pumps and oil lines at the completion of cargo discharge:
 - .1 drainings capable of being discharged to cargo tank or slop tank
 - .2 for discharge ashore a special small-diameter line is provided
- 8. Shipboard oil pollution emergency plan (regulation 37)**
 - 8.1 The ship is provided with a shipboard oil pollution emergency plan in accordance with regulation 37
 - 8.2 The ship is provided with a shipboard oil pollution emergency plan in accordance with regulation 37.3

9. Exemption

- 9.1 Exemptions have been granted by the Administration from the requirements of chapter 3 of Annex I of the Convention in accordance with regulation 3.1 on those items listed under paragraph(s)

.....

 Of this record

10. Equivalentents (regulation 5)

- 10.1 Equivalentents have been approved by the Administration for certain requirements of Annex I on those items listed under paragraph(s) :
 Of this record

THIS IS TO CERTIFY that this Record is correct in all respects.

Issued at

.....
(Place of issue of the Record)

.....
(Date of issue)

.....
(Signature of duly authorized officer issuing the Record)

(Seal or stamp of issuing authority, as appropriate)

A N N E X 1 A

SOLAS and ISPS Code Certificates and evidence of the Stockholm Agreement

Passenger Ship Safety Certificate	1
Sikkerhedscertifikat for passagerskibe	
Record of Equipment (Form P)	5
Udrustningsfortegnelse (Formular P)	
Cargo Ship Safety Construction Certificate	10
Konstruktionssikkerhedscertifikat for lastskibe	
Cargo Ship Safety Equipment Certificate	16
Udrustningssikkerhedscertifikat for lastskibe	
Record of Equipment (Form E)	21
Udrustningsfortegnelse (Formular E)	
Cargo Ship Safety Radio Certificate	25
Radiosikkerhedscertifikat for lastskibe	
Record of Equipment of Radio Facilities (Form R)	30
Udrustningsfortegnelse for radioudstyr (Formular R)	
Cargo Ship Safety Certificate	32
Sikkerhedscertifikat for lastskibe	
Record of Equipment (Form C)	42
Udrustningsfortegnelse (Formular C)	
Exemption Certificate	47
Undtagelsescertifikat	

Nuclear Passenger Ship Safety Certificate	49
Sikkerhedscertifikat for atomdrevne passagerskibe	
Record of Equipment (Form PNUC)	52
Udrustningsfortegnelse for atomdrevne passagerskibe (Formular PNUC)	
Nuclear Cargo Ship Safety Certificate	57
Sikkerhedscertifikat for atomdrevne lastskibe	
Record of Equipment (Form CNUC)	60
Udrustningsfortegnelse for atomdrevne lastskibe (Formular CNUC)	
International Ship Security Certificate (ISSP Security Code)	65
Internationalt certifikat om sikring af skibe (ISSP security)	
Interim International Ship Security Certificate (Interim ISSP)	69
Midlertidigt internationalt certifikat om sikring af skibe (ISSP security)	
Evidence of Ship Compliance concerning Damage stability of Ro-Ro Passenger ships (Stockholm Agreement)	70
Certifikat for opfyldelsen af de særlige stabilitetskrav for ro-ro passager- skibe i Stockholmaftalen og direktiv 2003/25/EF	



PASSENGER SHIP SAFETY CERTIFICATE

This certificate shall be supplemented by a Record of Equipment (Form P)
for $\frac{\text{an}^1}{\text{a short}}$ international voyage

Issued under the provisions of the
INTERNATIONAL CONVENTION FOR THE SAFETY OF LIFE AT SEA, 1974,
as modified by the Protocol of 1988 relating thereto
under the authority of the Government of

The Kingdom of Denmark

by

DANISH MARITIME AUTHORITY

*Particulars of ship*²

Name of ship

.....

Distinctive number or letters

.....

Port of registry

.....

Gross tonnage

.....

Sea areas in which ship is certified
to operate (regulation IV/2)

.....

IMO Number³

.....

Date of build:

- Date of building contract
- Date on which keel was laid or ship was at similar stage of construction
- Date of delivery
- Date on which work for a conversion or an alteration or modification of a major character was commenced (where applicable)

.....

.....

.....

.....

All applicable dates shall be completed.

¹ Delete as appropriate.

² Alternatively, the particulars of the ship may be placed horizontally in boxes.

³ In accordance with IMO ship identification number scheme adopted by the Organization by resolution A.600(15).

THIS IS TO CERTIFY:

1. That the ship has been surveyed in accordance with the requirements of regulation I/7 of the Convention.
2. That the survey showed that:
 - 2.1 the ship complied with the requirements of the Convention as regards:
 - .1 the structure, main and auxiliary machinery, boilers and other pressure vessels;
 - .2 the watertight subdivision arrangements and details;
 - .3 the following subdivision load lines;

Subdivision load lines assigned and marked on the ship's side at amidships (regulations II-1/18 ⁴)	Freeboard	To apply when the spaces in which passengers are carried include the following alternative spaces
P.1
P.2
P.3

- 2.2 the ship complied with the requirements of the Convention as regards structural fire protection, fire safety systems and appliances and fire control plans;
- 2.3 the life-saving appliances and the equipment of the lifeboats, liferafts and rescue boats were provided in accordance with the requirements of the Convention;
- 2.4 the ship was provided with a line-throwing appliance and radio installations used in life-saving appliances in accordance with the requirements of the Convention;
- 2.5 the ship complied with the requirements of the Convention as regards radio installations;

⁴ For ships constructed before 1 January 2009, the applicable subdivision notation “C.1, C.2 and C.3” should be used.

- 2.6 the functioning of the radio installation used in life-saving appliances complied with the requirements of the Convention;
- 2.7 the ship complied with the requirements of the Convention as regards shipborne navigational equipment, means of embarkation for pilots and nautical publications;
- 2.8 the ship was provided with lights, shapes, means of making sound signals and distress signals, in accordance with the requirements of the Convention and the International Regulations for Preventing Collisions at Sea in force;
- 2.9 in all other respects the ship complied with the relevant requirements of the Convention.

3. That an Exemption Certificate has/has not⁵ been issued.

This certificate is valid until

Completion date of the survey
on which this certificate is
based

(dd/mm/yyyy)

Issued at

(Place of issue of certificate)

.....
(Date of issue)

.....
(Signature of authorized official issuing the certificate)

(Seal or stamp of the issuing authority, as appropriate)

⁵ Delete as appropriate.

Endorsement where the renewal survey has been completed and regulation I/14(d) applies

The ship complies with the relevant requirements of the Convention, and this certificate shall, in accordance with regulation I/14(d) of the Convention, be accepted as valid until

.....
Signed:
(Signature of authorized official)

Place:

Date:

(Seal or stamp of the issuing authority, as appropriate)

Endorsement to extend the validity of the certificate until reaching the port of survey or for a period of grace where regulation I/14(e) or I/14(f) applies

This certificate shall, in accordance with regulation I/14(e)/I/14(f)¹ of the Convention, be accepted as valid until

.....
Signed:
(Signature of authorized official)

Place:

Date:

(Seal or stamp of the issuing authority, as appropriate)



*RECORD OF EQUIPMENT FOR THE
PASSENGER SHIP SAFETY CERTIFICATE (Form P)*

This Record shall be permanently attached to the
Passenger Ship Safety Certificate

**RECORD OF EQUIPMENT FOR COMPLIANCE
WITH THE INTERNATIONAL CONVENTION
FOR THE SAFETY OF LIFE AT SEA, 1974
as modified by the Protocol of 1988 relating thereto**

1 Particulars of ship

Name of ship

Distinctive number or letters

Number of passengers for which certified

Minimum number of persons with required qualifications to operate the radio installations

2 Details of life-saving appliances

1 Total number of persons for which life-saving appliances are provided		
	Port side	Starboard side
2 Total numbers of lifeboats
2.1 Total numbers of persons accommodated by them
2.2 Number of partially enclosed lifeboats (regulation III/2 1 and LSA Code, section 4.5)
2.3 Number of totally enclosed lifeboats (regulation III/2 1 and LSA Code, section 4.6)
2.4 Other lifeboats
2.4.1 Number
2.5.2 Type

2 *Details of life-saving appliances (continued)*

3	Number of motor lifeboats included in the total lifeboats shown above
3.1	Number of lifeboats fitted with searchlights
4.	Number of rescue boats
4.1	Number of boats which are included in the total lifeboats shown above
5	Liferafts
5.1	Those for which approved launching appliances are required
5.1.1	Number of liferafts
5.1.2	Number of persons accommodated by them
5.2	Those for which approved launching appliances are not required
5.2.1	Number of liferafts
5.2.2	Number of persons accommodated by them
6	Buoyant apparatus
6.1	Number of apparatus
6.2	Number of persons capable of being supported
7	Number of lifebuoys
8	Number of lifejackets
9	Immersion suits
9.1	Total number
9.2	Number of suits complying with the requirements for lifejackets
10	Number of thermal protective aids ¹
11	Radio installations used in life-saving appliances
11.1	Number of search and rescue locating devices
11.1.1	Radar search and rescue transponders (SART)
11.1.2	AIS search and rescue transmitters (AIS-SART)
11.2	Number of two-way VHF radiotelephone apparatus

¹ Excluding those required by LSA Code paragraphs 4.1.5.1.24, 4.4.8.31 and 5.1.2.2.13.

3 Details of radio facilities

Item	Actual provision
1 Primary systems
1.1 VHF radio installation
1.1.1 DSC encoder
1.1.2 DSC watch receiver
1.1.3 Radiotelephony
1.2 MF radio installation
1.2.1 DSC encoder
1.2.2 DSC watch receiver
1.2.3 Radiotelephony
1.3 MF/HF radio installation
1.3.1 DSC encoder
1.3.2 DSC watch receiver
1.3.3 Radiotelephony
1.3.4 Direct-printing radiotelegraphy
1.4 INMARSAT ship earth station
2 Secondary means of alerting
3 Facilities for reception of maritime safety information
3.1 NAVTEX receiver
3.2 EGC receiver
3.3 HF direct-printing radiotelegraph receiver
4 Satellite EPIRB
4.1 COSPASS-SARSAT
4.2 INMARSAT
5 VHF EPIRB
6 Ship's search and rescue locating device
6.1 Radar search and rescue transponder (SART)
6.2 AIS search and rescue transmitter (AIS-SART)

4 *Methods used to ensure availability of radio facilities* (regulations IV/15.6 and 15.7)

- 4.1 Duplication of equipment
- 4.2 Shore-based maintenance
- 4.3 At-sea maintenance capability

5 *Details of navigational systems and equipment*

Item	Actual provision
1.1 Standard magnetic compass ¹
1.2 Spare magnetic compass ¹
1.3 Gyro-compass ¹
1.4 Gyro-compass heading repeater ¹
1.5 Gyro-compass bearing repeater ¹
1.6 Heading or track control system ¹
1.7 Pelorus or compass bearing device ¹
1.8 Means of correcting heading and bearings
1.9 Transmitting heading device (THD) ¹
2.1 Nautical charts/Electronic chart display and information system (ECDIS) ^{2, 1}
2.2 Back-up arrangements for ECDIS
2.3 Nautical publications
2.4 Back-up arrangements for electronic nautical publications
3.1 Receiver for a global navigation satellite system/terrestrial radionavigation system ^{2, 1}
3.2 9 GHz radar ¹
3.3 Second radar (3 GHz/9 GHz ²) ¹
3.4 Automatic radar plotting aid (ARPA) ¹
3.5 Automatic tracking aid
3.6 Second automatic tracking aid
3.7 Electronic plotting aid ¹
4.1 Automatic identification system (AIS)
4.2 Long-range identification and tracking system

¹ Alternative means of meeting this requirement are permitted under regulation V/19. In case of other means they shall be specified.

² Delete as appropriate.

5 *Details of navigational systems and equipment (continued)*

Item	Actual provision
5 Voyage data recorder (VDR)	
6.1 Speed and distance measuring device (through the water) ¹	
6.2 Speed and distance measuring device (over the ground in the forward and athwartship direction) ¹	
7 Echo-sounding device ¹	
8.1 Rudder, propeller, thrust, pitch and operational mode indicator ¹	
8.2 Rate-of-turn indicator ¹	
9 Sound reception system ¹	
10 Telephone to emergency steering position ¹	
11 Daylight signaling lamp ¹	
12 Radar reflector ¹	
13 International Code of Signals	

THIS IS TO CERTIFY that this Record is correct in all respects

Issued at

.....
(Place of issue of the Record)

.....
(Date of issue)

.....
(Signature of authorized official issuing the Record)

(Seal or stamp of the issuing authority, as appropriate)

¹ Alternative means of meeting this requirement are permitted under regulation V/19. In case of other means they shall be specified.



CARGO SHIP SAFETY CONSTRUCTION CERTIFICATE

Issued under the provisions of the

INTERNATIONAL CONVENTION FOR THE SAFETY OF LIFE AT SEA, 1974,
as modified by the Protocol of 1988 relating thereto

under the authority of the Government of

The Kingdom of Denmark

by **DANISH MARITIME AUTHORITY**

Particulars of ship

Name of ship

Distinctive number or letters

Port of registry

Gross tonnage

Deadweight of ship (metric tons)¹

IMO Number

Type of ship²

Bulk carrier

Oil tanker

Chemical tanker

Gas carrier

Cargo ship other than any of the above

Date of build:

- Date of building contract

- Date on which keel was laid or ship was at
similar stage of construction

- Date of delivery

- Date on which work for a conversion or an
alteration or modification of a major
character was commenced (where
applicable)

All applicable dates shall be completed.

¹ For oil tankers, chemical tankers and gas carriers only.

² Delete as appropriate.

THIS IS TO CERTIFY:

1. That the ship has been surveyed in accordance with the requirements of regulation I/10 of the Convention.
2. That the survey showed that the condition of the structure, machinery and equipment as defined in the above regulation was satisfactory and the ship complied with the relevant requirements of chapters II-1 and II-2 of the Convention (other than those relating to fire safety systems and appliances and fire control plans).
3. That the last two inspections of the outside of the ship's bottom took place on and
(dates)
4. That an Exemption Certificate has/has not¹ been issued.

This certificate is valid until² subject to the annual and intermediate surveys and inspections of the outside of the ship's bottom in accordance with regulation I/10 of the Convention.

Issued at

.....
(Place of issue of certificate)

Completion date of the survey on which this certificate is based

.....
dd/mm/yyyy

.....
(Date of issue)

.....
(Signature of authorized official issuing the certificate)

(Seal or stamp of the issuing authority, as appropriate)

¹ Delete as appropriate.

² Insert the date of expiry as specified by the Administration in accordance with regulation I/14(a) of the Convention. The day and the month of this date correspond to the anniversary date as defined in regulation I/2(n) of the Convention, unless amended in accordance with regulation I/14(h).

Endorsement for annual and intermediate surveys

THIS IS TO CERTIFY that, at a survey required by regulation I/10 of the Convention, the ship was found to comply with the relevant requirements of the Convention.

Annual survey: Signed:
(Signature of authorized official)
Place:
Date:
(Seal or stamp of the issuing authority, as appropriate)

Annual/Intermediate¹ survey: Signed:
(Signature of authorized official)
Place:
Date:
(Seal or stamp of the issuing authority, as appropriate)

Annual/Intermediate¹ survey: Signed:
(Signature of authorized official)
Place:
Date:
(Seal or stamp of the issuing authority, as appropriate)

Annual survey: Signed:
(Signature of authorized official)
Place:
Date:
(Seal or stamp of the issuing authority, as appropriate)

¹ Delete as appropriate.

Annual/Intermediate survey in accordance with regulation I/14(h)(iii)

THIS IS TO CERTIFY that, at an annual/intermediate¹ survey in accordance with regulation I/14(h)(iii) of the Convention, the ship was found to comply with the relevant requirements of the Convention.

Signed:
(Signature of authorized official)

Place:

Date:

(Seal or stamp of the issuing authority, as appropriate)

Endorsement for inspections of the outside of the ship's bottom²

THIS IS TO CERTIFY that, at an inspection required by regulation I/10 of the Convention, the ship was found to comply with the relevant requirements of the Convention.

First inspection: Signed:
(Signature of authorized official)

Place:

Date:

(Seal or stamp of the issuing authority, as appropriate)

Second inspection: Signed:
(Signature of authorized official)

Place:

Date:

(Seal or stamp of the issuing authority, as appropriate)

¹ Delete as appropriate.

² Provision may be made for additional inspections.

Endorsement to extend the certificate if valid for less than 5 years where regulation I/14(c) applies

The ship complies with the relevant requirements of the Convention, and this certificate shall, in accordance with regulation I/14(c) of the Convention, be accepted as valid until

.....
Signed:
(Signature of authorized official)

Place:

Date:

(Seal or stamp of the issuing authority, as appropriate)

Endorsement where the renewal survey has been completed and regulation I/14(d) applies

The ship complies with the relevant requirements of the Convention, and this certificate shall, in accordance with regulation I/14(d) of the Convention, be accepted as valid until

.....
Signed:
(Signature of authorized official)

Place:

Date:

(Seal or stamp of the issuing authority, as appropriate)

Endorsement to extend the validity of the certificate until reaching the port of survey or a period of grace where regulation I/14(e) or I/14(f) applies

This certificate shall, in accordance with regulation I/14(e)/I/14(f)¹ of the Convention, be accepted as valid until

.....
Signed:
(Signature of authorized official)

Place:

Date:

(Seal or stamp of the issuing authority, as appropriate)

¹ Delete as appropriate.

Endorsement for advancement of anniversary date where regulation I/14(h) applies

In accordance with regulation I/14(h) of the Convention, the new anniversary date is

.....
Signed:

.....
(Signature of authorized official)

Place:

Date:

(Seal or stamp of the issuing authority, as appropriate)

In accordance with regulation I/14(h) of the Convention, the new anniversary date is

.....
Signed:

.....
(Signature of authorized official)

Place:

Date:

(Seal or stamp of the issuing authority, as appropriate)



CARGO SHIP SAFETY EQUIPMENT CERTIFICATE

This certificate shall be supplemented by a Record of Equipment
(Form E)

Issued under the provisions of the
INTERNATIONAL CONVENTION FOR THE SAFETY OF LIFE
AT SEA, 1974 as modified by the Protocol of 1988 relating thereto

under the authority of the Government of

The Kingdom of Denmark

by

DANISH MARITIME AUTHORITY

Particulars of ship

Name of ship

Distinctive number or letters

Port of registry

Gross tonnage

Deadweight of ship (metric tons)¹

Length of ship (regulation III/3.12)

IMO Number

*Type of ship*²

Bulk carrier

Oil tanker

Chemical tanker

Gas carrier

Cargo ship other than any of the above

Date on which keel was laid or ship was at a similar stage of
construction or, where applicable, date on which work for a
conversion or an alteration or modification of a major
character was commenced

¹ For oil tankers, chemical tankers and gas carriers only.

² Delete as appropriate.

THIS IS TO CERTIFY:

1. That the ship has been surveyed in accordance with the requirements of regulation I/8 of the Convention.
2. That the survey showed that:
 - 2.1 the ship complied with the requirements of the Convention as regards fire safety systems and appliances and fire control plans;
 - 2.2 the life-saving appliances and the equipment of the lifeboats, liferafts and rescue boats were provided in accordance with the requirements of the Convention;
 - 2.3 the ship was provided with a line-throwing appliance and radio installations used in life-saving appliances in accordance with the requirements of the Convention;
 - 2.4 the ship complied with the requirements of the Convention as regards shipborne navigational equipment, means of embarkation for pilots and nautical publications;
 - 2.5 the ship was provided with lights, shapes and means of making sound signals and distress signals, in accordance with the requirements of the Convention and the International Regulations for Preventing Collisions at Sea in force;
 - 2.6 in all other respects the ship complied with the relevant requirements of the Convention.
3. That an Exemption Certificate has/has not¹ been issued.

This certificate is valid until² subject to the annual and periodical surveys in accordance with regulation I/8 of the Convention.

Issued at

.....
(Place of issue of certificate)

Completion date of the survey on which this certificate is based

.....
dd/mm/yyyy

.....
(Date of issue)

.....
(Signature of authorized official issuing the certificate)

(Seal or stamp of the issuing authority, as appropriate)

¹ Delete as appropriate.

² Insert the date of expiry as specified by the Administration in accordance with regulation I/14(a) of the Convention. The day and month of this date correspond to the anniversary date as defined in regulation I/2(n) of the Convention, unless amended in accordance with regulation I/14(h).

Endorsement for annual and periodical surveys

THIS IS TO CERTIFY that, at a survey required by regulation I/8 of the Convention, the ship was found to comply with the relevant requirements of the Convention.

Annual survey: Signed:
(Signature of authorized official)

Place:

Date:

(Seal or stamp of the issuing authority, as appropriate)

Annual/Periodical¹ survey: Signed:
(Signature of authorized official)

Place:

Date:

(Seal or stamp of the issuing authority, as appropriate)

Annual/Periodical¹ survey: Signed:
(Signature of authorized official)

Place:

Date:

(Seal or stamp of the issuing authority, as appropriate)

Annual survey: Signed:
(Signature of authorized official)

Place:

Date:

(Seal or stamp of the issuing authority, as appropriate)

¹ Delete as appropriate.

Annual/periodical survey in accordance with regulation I/14(h)(iii)

THIS IS TO CERTIFY that, at the annual/periodical¹ survey in accordance with regulation I/14(h)(iii) of the Convention, the ship was found to comply with the relevant requirements of the Convention.

Signed:
(Signature of authorized official)

Place:

Date:

(Seal or stamp of the issuing authority, as appropriate)

Endorsement to extend the certificate if valid for less than 5 years where regulation I/14(c) applies

The ship complies with the relevant requirements of the Convention, and this certificate shall, in accordance with regulation I/14(c) of the Convention, be accepted as valid until

.....

Signed:
(Signature of authorized official)

Place:

Date:

(Seal or stamp of the issuing authority, as appropriate)

Endorsement where the renewal survey has been completed and regulation I/14(d) applies

The ship complies with the relevant requirements of the Convention, and this certificate shall, in accordance with regulation I/14(d) of the Convention, be accepted as valid until

.....

Signed:
(Signature of authorized official)

Place:

Date:

(Seal or stamp of the issuing authority, as appropriate)

¹ Delete as appropriate.

Endorsement to extend the validity of the certificate until reaching the port of survey or a period of grace where regulation I/14(e) or I/14(f) applies

This certificate shall, in accordance with regulation I/14(e)/I/14(f)¹ of the Convention, be accepted as valid until

Signed:
(Signature of authorized official)

Place:

Date:

(Seal or stamp of the issuing authority, as appropriate)

Endorsement for advancement of anniversary date where regulation I/14(h) applies

In accordance with regulation I/14(h) of the Convention, the new anniversary date is

.....

Signed:
(Signature of authorized official)

Place:

Date:

(Seal or stamp of the issuing authority, as appropriate)

In accordance with regulation I/14(h) of the Convention, the new anniversary date is

.....

Signed:
(Signature of authorized official)

Place:

Date:

(Seal or stamp of the issuing authority, as appropriate)



*RECORD OF EQUIPMENT FOR THE
CARGO SHIP SAFETY EQUIPMENT CERTIFICATE (Form E)*

This Record shall be permanently attached to the
Cargo Ship Safety Certificate

**RECORD OF EQUIPMENT FOR COMPLIANCE
WITH THE INTERNATIONAL CONVENTION
FOR THE SAFETY OF LIFE AT SEA, 1974
as modified by the Protocol of 1988 relating thereto**

1 Particulars of ship

Name of ship

Distinctive number or letters

2 Details of life-saving appliances

1	Total number of persons for which life-saving appliances are provided	
		Port side	Starboard side
2	Total numbers of lifeboats
2.1	Total numbers of persons accommodated by them
2.2	Number of totally enclosed lifeboats (regulation III/3 1 and LSA Code, section 4.6)
2.3	Number of lifeboats with a self-contained air support system (regulation III/3 1 and LSA Code, section 4.8)
2.4	Number of fire-protected lifeboats (regulation III/3 1 and LSA Code, section 4.9)
2.5	Other lifeboats
2.5.1	Number
2.5.2	Type

2 Details of life-saving appliances (continued)

2.6	Number of freefall lifeboats
2.6.1	Totally enclosed (regulation III/3 1 and LSA Code, section 4.7)
2.6.2	Self-contained (regulation III/3 1 and LSA Code, section 4.8)
2.6.3	Fire-protected (regulation III/3 1 and LSA Code, section 4.9)
3	Number of motor lifeboats (included in the total lifeboats shown above)
3.1	Number of lifeboats fitted with searchlights
4.	Number of rescue boats
4.1	Number of boats which are included in the total lifeboats shown above
5	Liferafts
5.1	Those for which approved launching appliances are required
5.1.1	Number of liferafts
5.1.2	Number of persons accommodated by them
5.2	Those for which approved launching appliances are not required
5.2.1	Number of liferafts
5.2.2	Number of persons accommodated by them
5.3	Number of liferafts required by regulation III/31.1.4
6	Number of lifebuoys
7	Number of lifejackets
8	Immersion suits
8.1	Total number
8.2	Number of suits complying with the requirements for lifejackets
9	Radio installations used in life-saving appliances
9.1	Number of search and rescue locating devices
9.1.1	Radar search and rescue transponders (SART)
9.1.2	AIS search and rescue transmitters (AIS-SART)
9.2	Number of two-way VHF Radiotelephone apparatus

3 Details of navigational systems and equipment

Item	Actual provision
1.1 Standard magnetic compass ¹
1.2 Spare magnetic compass ¹
1.3 Gyro-compass ¹
1.4 Gyro-compass heading repeater ¹
1.5 Gyro-compass bearing repeater ¹
1.6 Heading or track control system ¹
1.7 Pelorus or compass bearing device ¹
1.8 Means of correcting heading and bearings
1.9 Transmitting heading device (THD) ¹
2.1 Nautical charts/Electronic chart display and information system (ECDIS) ^{2, 1}
2.2 Back-up arrangements for ECDIS
2.3 Nautical publications
2.4 Back-up arrangements for electronic nautical publications
3.1 Receiver for a global navigation satellite system/terrestrial radionavigation system ^{2, 1}
3.2 9 GHz radar ¹
3.3 Second radar (3 GHz/9 GHz ²) ¹
3.4 Automatic radar plotting aid (ARPA) ¹
3.5 Automatic tracking aid
3.6 Second automatic tracking aid
3.7 Electronic plotting aid ¹
4.1 Automatic identification system (AIS)
4.2 Long-range identification tracking system
5.1 Voyage data recorder (VDR)
5.2 Simplified voyage data recorder (S-VDR) ²
6.1 Speed and distance measuring device (through the water) ¹
6.2 Speed and distance measuring device (over the ground in the forward and athwart ship direction) ¹
6.3 Echo-sounding device ¹

¹ Alternative means of meeting this requirement are permitted under regulation V/19. In case of other means they shall be specified.

² Delete as appropriate.

3 Details of navigational systems and equipment (continued)

Item	Actual provision
7.1 Rudder, propeller, thrust, pitch and operational mode indicator ¹
7.2 Rate-of-turn indicator ¹
8 Sound reception system ¹
9 Telephone to emergency steering position ¹
10 Daylight signaling lamp ¹
11 Radar reflector ¹
12 International Code of Signals
13 IAMSAR Manual, Volume III

THIS IS TO CERTIFY that this Record is correct in all respects

Issued at

.....
(Place of issue of record)

.....
(Date of issue)

.....
(Signature of authorized official issuing the record)

(Seal or stamp of the issuing authority, as appropriate)

¹ Alternative means of meeting this requirement are permitted under regulation V/19. In case of other means they shall be specified.
² Delete as appropriate.



CARGO SHIP SAFETY RADIO CERTIFICATE

This certificate shall be supplemented by a Record of Equipment
of Radio Facilities (Form R)

Issued under the provisions of the
INTERNATIONAL CONVENTION FOR THE SAFETY OF LIFE
AT SEA, 1974 as modified by the Protocol of 1988 relating thereto

under the authority of the Government of

The Kingdom of Denmark

by

DANISH MARITIME AUTHORITY

Particulars of ship

Name of ship

Distinctive number or letters

Port of registry

Gross tonnage

Sea areas in which ship is certified to
operate (regulation IV/2)

IMO Number

Date on which keel was laid or ship was at a similar stage of
construction or, where applicable, date on which work for a
conversion or an alteration or modification of a major
character was commenced

THIS IS TO CERTIFY:

1. That the ship has been surveyed in accordance with the requirements of regulation I/9 of the Convention.
2. That the survey showed that:
 - 2.1 the ship complied with the requirements of the Convention as regards radio installations;
 - 2.2 the functioning of the radio installations used in life-saving appliances complied with the requirements of the Convention;
3. That an Exemption Certificate has/has not¹ been issued.

This certificate is valid until² Subject to the periodical surveys in accordance with the regulation I/9 of the Convention.

Completion date of the survey on which this certificate is based

.....
(dd/mm/yyyy)

Issued at

.....
(Place of issue of certificate)

.....
(Date of issue)

.....
(Signature of authorized official issuing the certificate)

(Seal or stamp of the issuing authority, as appropriate)

¹ Delete as appropriate.

² Insert the date of expiry as specified by the Administration in accordance with regulation I/14(a) of the Convention. The day and month of this date correspond to the anniversary date as defined in regulation I/2(n) of the Convention, unless amended in accordance with regulation I/14(h).

Endorsement for periodical surveys

THIS IS TO CERTIFY that, at a survey required by regulation I/9 of the Convention, the ship was found to comply with the relevant requirements of the Convention.

Periodical survey: Signed:
(Signature of authorized official)

Place:

Date:

(Seal or stamp of the issuing authority, as appropriate)

Periodical survey: Signed:
(Signature of authorized official)

Place:

Date:

(Seal or stamp of the issuing authority, as appropriate)

Periodical survey: Signed:
(Signature of authorized official)

Place:

Date:

(Seal or stamp of the issuing authority, as appropriate)

Periodical survey: Signed:
(Signature of authorized official)

Place:

Date:

(Seal or stamp of the issuing authority, as appropriate)

Periodical survey in accordance with regulation I/14(h)(iii)

THIS IS TO CERTIFY that, at a periodical survey in accordance with regulation I/14(h)(iii) of the Convention, the ship was found to comply with the relevant requirements of the Convention.

Signed:
(Signature of authorized official)

Place:

Date:

(Seal or stamp of the issuing authority, as appropriate)

Endorsement to extend the certificate if valid for less than 5 years where regulation I/14(c) applies

The ship complies with the relevant requirements of the Convention, and this certificate shall, in accordance with regulation I/14(c) of the Convention, be accepted as valid until

.....

Signed:
(Signature of authorized official)

Place:

Date:

(Seal or stamp of the issuing authority, as appropriate)

Endorsement where the renewal survey has been completed and regulation I/14(d) applies

The ship complies with the relevant requirements of the Convention, and this certificate shall, in accordance with regulation I/14(d) of the Convention, be accepted as valid until

.....

Signed:
(Signature of authorized official)

Place:

Date:

(Seal or stamp of the issuing authority, as appropriate)

Endorsement to extend the validity of the certificate until reaching the port of survey or for a period of grace where regulation I/14(e) or I/14(f) applies

This certificate shall, in accordance with regulation I/14(e)/I/14(f)¹ of the Convention, be accepted as valid until

.....
Signed:
(Signature of authorized official)

Place:

Date:

(Seal or stamp of the issuing authority, as appropriate)

Endorsement for advancement of anniversary date where regulation I/14(h) applies

In accordance with regulation I/14(h) of the Convention, the new anniversary date is

.....
Signed:
(Signature of authorized official)

Place:

Date:

(Seal or stamp of the issuing authority, as appropriate)

In accordance with regulation I/14(h) of the Convention, the new anniversary date is

.....
Signed:
(Signature of authorized official)

Place:

Date:

(Seal or stamp of the issuing authority, as appropriate)

¹ Delete as appropriate.



*RECORD OF EQUIPMENT FOR THE
CARGO SHIP SAFETY RADIO CERTIFICATE (Form R)*

This Record shall be permanently attached to the
Cargo Ship Safety Radio Certificate

**RECORD OF EQUIPMENT FOR COMPLIANCE
WITH THE INTERNATIONAL CONVENTION
FOR THE SAFETY OF LIFE AT SEA, 1974
as modified by the Protocol of 1988 relating thereto**

1 Particulars of ship

Name of ship

Distinctive number or letters

Minimum number of persons with required
qualifications to operate the radio installations

2 Details of radio facilities

Item	Actual provision
1 Primary systems
1.1 VHF radio installation
1.1.1 DSC encoder
1.1.2 DSC watch receiver
1.1.3 Radiotelephony
1.2 MF radio installation
1.2.1 DSC encoder
1.2.2 DSC watch receiver
1.2.3 Radiotelephony
1.3 MF/HF radio installation
1.3.1 DSC encoder
1.3.2 DSC watch receiver
1.3.3 Radiotelephony
1.3.4 Direct-printing radiotelegraphy
1.4 INMARSAT ship earth station
2 Secondary means of alerting



CARGO SHIP SAFETY CERTIFICATE

This certificate shall be supplemented by a Record of Equipment (Form C)

Issued under the provisions of the
INTERNATIONAL CONVENTION FOR THE SAFETY OF LIFE AT SEA, 1974,
as modified by the Protocol of 1988 relating thereto

under the authority of the Government of

The Kingdom of Denmark

by **DANISH MARITIME AUTHORITY**

Particulars of ship

Name of ship

Distinctive number or letters

Port of registry

Gross tonnage

Deadweight of ship (metric tons)¹

Length of ship (regulation III/3.12)

Sea areas in which ship is certified to
operate (regulation IV/2)

IMO Number

Type of ship²

- Bulk carrier
- Oil tanker
- Chemical tanker
- Gas carrier
- Cargo ship other than any of the above

Date of build:

- Date of building contract
- Date on which keel was laid or ship was at similar stage of
construction
- Date of delivery
- Date on which work for a conversion or an alteration or modification
of a major character was commenced (where applicable)

All applicable dates shall be completed.

¹ For oil tankers, chemical tankers and gas carriers only.

² Delete as appropriate.

THIS IS TO CERTIFY:

1. That the ship has been surveyed in accordance with the requirements of regulation I/8, I/9 and I/10 of the Convention.
2. That the survey showed that:
 - 2.1 the condition of the structure, machinery and equipment as defined in regulation I/10 was satisfactory and the ship complied with the relevant requirements of chapter II-1 and chapter II-2 of the Convention (other than those relating to fire safety systems and appliances and fire control plans);
 - 2.2 the last two inspections of the outside of the ship's bottom took place on
..... and
(dates)
 - 2.3 the ship complied with the requirements of the Convention as regards fire safety systems and appliances and fire control plans;
 - 2.4 the life-saving appliances and the equipment of the lifeboats, liferafts and rescue boats were provided in accordance with the requirements of the Convention;
 - 2.5 the ship was provided with a line-throwing appliance and radio installations used in life-saving appliances in accordance with the requirements of the Convention;
 - 2.6 the ship complied with the requirements of the Convention as regards radio installations;
 - 2.7 the functioning of the radio installation used in life-saving appliances complied with the requirements of the Convention;
 - 2.8 the ship complied with the requirements of the Convention as regards shipborne navigational equipment, means of embarkation for pilots and nautical publications;
 - 2.9 the ship was provided with lights, shapes, means of making sound signals and distress signals, in accordance with the requirements of the Convention and the International Regulations for Preventing Collisions at Sea in force;
 - 2.10 in all other respects the ship complied with the relevant requirements of the Convention.
- 3 That an Exemption Certificate has/has not¹ been issued.

¹ Delete as appropriate.

This certificate is valid until¹ subject to the annual, intermediate and periodical surveys and inspections of the outside of the ship's bottom in accordance with regulation I/8, I/9 and I/10 of the Convention.

Completion date of the survey on which this certificate is based
(dd/mm/yyyy)

Issued at
(Place of issue of certificate)

.....
Date of issue) (Signature of authorized official issuing the certificate)
(Seal or stamp of the issuing authority, as appropriate)

¹ Insert the date of expiry as specified by the Administration in accordance with regulation I/14(a) of the Convention. The day and month of this date correspond to the anniversary date as defined in regulation I/2(n) of the Convention, unless amended in accordance with regulation I/14(h).

Endorsement for annual and intermediate surveys relating to structure, machinery and equipment referred to in paragraph 2.1 of this certificate

THIS IS TO CERTIFY that, at a survey required by regulation I/10 of the Convention, the ship was found to comply with the relevant requirements of the Convention.

Annual survey: Signed:
(Signature of authorized official)

Place:

Date:

(Seal or stamp of the issuing authority, as appropriate)

Annual/Intermediate¹ survey: Signed:
(Signature of authorized official)

Place:

Date:

(Seal or stamp of the issuing authority, as appropriate)

Annual/Intermediate⁵ survey: Signed:
(Signature of authorized official)

Place:

Date:

(Seal or stamp of the issuing authority, as appropriate)

Annual survey: Signed:
(Signature of authorized official)

Place:

Date:

(Seal or stamp of the issuing authority, as appropriate)

¹ Delete as appropriate.

Annual/intermediate survey in accordance with regulation I/14(h)(iii)

THIS IS TO CERTIFY that, at an annual/intermediate¹ surveyed in accordance with regulation I/10 and I/14(h)(iii) of the Convention, the ship was found to comply with the relevant requirements of the Convention.

Signed:
(Signature of authorized official)

Place:

Date:

(Seal or stamp of the issuing authority, as appropriate)

Endorsement for inspections of the outside of the ship's bottom²

THIS IS TO CERTIFY that, at an inspection required by regulation I/10 of the Convention, the ship was found to comply with the relevant requirements of the Convention.

First inspection: Signed:
(Signature of authorized official)

Place:

Date:

(Seal or stamp of the issuing authority, as appropriate)

Second inspection: Signed:
(Signature of authorized official)

Place:

Date:

(Seal or stamp of the issuing authority, as appropriate)

¹ Delete as appropriate.

² Provisions may be made for additional inspections.

**Endorsement for annual and periodical surveys relating to life-saving appliances
and other equipment referred to in paragraphs 2.3, 2.4, 2.5, 2.8 and 2.9 of
this certificate**

THIS IS TO CERTIFY that, at a survey required by regulation I/8 of the Convention, the ship was found to comply with the relevant requirements of the Convention.

Annual survey: Signed:
(Signature of authorized official)

Place:

Date:

(Seal or stamp of the issuing authority, as appropriate)

Annual/Periodical¹ survey: Signed:
(Signature of authorized official)

Place:

Date:

(Seal or stamp of the issuing authority, as appropriate)

Annual/Periodical⁵ survey: Signed:
(Signature of authorized official)

Place:

Date:

(Seal or stamp of the issuing authority, as appropriate)

Annual survey: Signed:
(Signature of authorized official)

Place:

Date:

(Seal or stamp of the issuing authority, as appropriate)

¹ Delete as appropriate.

Annual/periodical survey in accordance with regulation I/14(h)(iii)

THIS IS TO CERTIFY that, at an annual/periodical¹ survey in accordance with regulations I/8 and I/14(h)(iii) of the Convention, the ship was found to comply with the relevant requirements of the Convention.

Signed:
(Signature of authorized official)

Place:

Date:

(Seal or stamp of the issuing authority, as appropriate)

¹ Delete as appropriate.

Endorsement for annual and periodical surveys relating to radio installations referred to in paragraphs 2.6 and 2.7 of this certificate

THIS IS TO CERTIFY that, at a survey required by regulation I/9 of the Convention, the ship was found to comply with the relevant requirements of the Convention.

Periodical survey: Signed:
(Signature of authorized official)

Place:

Date:

(Seal or stamp of the issuing authority, as appropriate)

Periodical survey: Signed:
(Signature of authorized official)

Place:

Date:

(Seal or stamp of the issuing authority, as appropriate)

Periodical survey: Signed:
(Signature of authorized official)

Place:

Date:

(Seal or stamp of the issuing authority, as appropriate)

Periodical survey: Signed:
(Signature of authorized official)

Place:

Date:

(Seal or stamp of the issuing authority, as appropriate)

Periodical survey in accordance with regulation I/14(h)(iii)

THIS IS TO CERTIFY that, at a periodical survey in accordance with regulations I/9 and I/14(h)(iii) of the Convention, the ship was found to comply with the relevant requirements of the Convention.

Signed:
(Signature of authorized official)

Place:

Date:

(Seal or stamp of the issuing authority, as appropriate)

Endorsement to extend the certificate if valid for less than 5 years where regulation I/14(c) applies

The ship complies with the relevant requirements of the Convention, and this certificate shall, in accordance with regulation I/14(c) of the Convention, be accepted as valid until

.....
Signed:
(Signature of authorized official)

Place:

Date:

(Seal or stamp of the issuing authority, as appropriate)

Endorsement where the renewal survey has been completed and regulation I/14(d) applies

The ship complies with the relevant requirements of the Convention, and this certificate shall, in accordance with regulation I/14(d) of the Convention, be accepted as valid until

.....
Signed:
(Signature of authorized official)

Place:

Date:

(Seal or stamp of the issuing authority, as appropriate)

**Endorsement to extend the validity of the certificate until reaching the port of survey
or a period of grace where regulation I/14(e) or I/14(f) applies**

This certificate shall, in accordance with regulation I/14(e)/I/14(f)¹ of the Convention, be
accepted as valid until

.....

Signed:
(Signature of authorized official)

Place:

Date:

(Seal or stamp of the issuing authority, as appropriate)

Endorsement for advancement of anniversary date where regulation I/14(h) applies

In accordance with regulation I/14(h) of the Convention, the new anniversary date is

.....

Signed:
(Signature of authorized official)

Place:

Date:

(Seal or stamp of the issuing authority, as appropriate)

In accordance with regulation I/14(h) of the Convention, the new anniversary date is

.....

Signed:
(Signature of authorized official)

Place:

Date:

(Seal or stamp of the issuing authority, as appropriate)

¹ Delete as appropriate.



*RECORD OF EQUIPMENT FOR THE
CARGO SHIP SAFETY CERTIFICATE (Form C)*

This Record shall be permanently attached to the
Cargo Ship Safety Certificate

**RECORD OF EQUIPMENT FOR COMPLIANCE
WITH THE INTERNATIONAL CONVENTION
FOR THE SAFETY OF LIFE AT SEA, 1974
as modified by the Protocol of 1988 relating thereto**

1 Particulars of ship

Name of ship

Distinctive number or letters

Minimum number of persons with required
qualifications to operate the radio installations

2 Details of life-saving appliances

1	Total number of persons for which life-saving appliances are provided	
		Port side	Starboard side
2	Total numbers of lifeboats
2.1	Total numbers of persons accommodated by them
2.2	Number of totally enclosed lifeboats (regulation III/3 1 and LSA Code section 4.6)
2.3	Number of lifeboats with a self contained air support system (regulation III/3 1 and LSA Code section 4.8)
2.4	Number of fire-protected lifeboats (regulation III/3 1 and LSA Code section 4.9)
2.5	Other lifeboats
2.5.1	Number
2.5.2	Type

2 *Details of life-saving appliances (continued)*

2.6	Number of free-fall lifeboats
2.6.1	Totally enclosed (regulation III/3 1 and LSA Code section 4.7)
2.6.2	Self-contained (regulation III/3 1 and LSA Code section 4.8)
2.6.3	Fire-protected (regulation III/3 1 and LSA Code section 4.9)
3	Number of motor lifeboats included in the total lifeboats shown above
3.1	Number of lifeboats fitted with searchlights
4.	Number of rescue boats
4.1	Number of boats which are included in the total lifeboats shown above
5	Liferafts
5.1	Those for which approved launching appliances are required
5.1.1	Number of liferafts
5.1.2	Number of persons accommodated by them
5.2	Those for which approved launching appliances are not required
5.2.1	Number of liferafts
5.2.2	Number of persons accommodated by them
5.3	Number of liferafts required by regulation III/31.1.4
6	Number of lifebuoys
7	Number of lifejackets
8	Immersion suits
8.1	Total number
8.2	Number of suits complying with the requirements for lifejackets
9	Radio installations used in life-saving appliances
9.1	Number of search and rescue locating devices
9.1.1	Radar search and rescue transponders (SART)
9.1.2	AIS search and rescue transmitters (AIS-SART)
9.2	Number of two-way VHF Radiotelephone apparatus

3 *Details of radio facilities*

Item	Actual provision
1 Primary systems
1.1 VHF radio installation
1.1.1 DSC encoder
1.1.2 DSC watch receiver
1.1.3 Radiotelephony
1.2 MF radio installation
1.2.1 DSC encoder
1.2.2 DSC watch receiver
1.2.3 Radiotelephony
1.3 MF/HF radio installation
1.3.1 DSC encoder
1.3.2 DSC watch receiver
1.3.3 Radiotelephony
1.3.4 Direct-printing radiotelegraphy
1.4 INMARSAT ship earth station
2 Secondary means of alerting
3 Facilities for reception of maritime safety information
3.1 NAVTEX receiver
3.2 EGC receiver
3.3 HF direct-printing radiotelegraph receiver
4 Satellite EPIRB
4.1 COSPASS-SARSAT
4.2 INMARSAT
5 VHF EPIRB
6 Ship's search and rescue locating device
6.1 Radar search and rescue transponder (SART)
6.2 AIS search and rescue transmitter (AIS-SART)

4 *Methods used to ensure availability of radio facilities*
(regulations IV/15.6 and 15.7)

4.1 Duplication of equipment
4.2 Shore based maintenance
4.3 At-sea maintenance capability

5 Details of navigational systems and equipment

Item	Actual provision
1.1 Standard magnetic compass ¹
1.2 Spare magnetic compass ¹
1.3 Gyro-compass ¹
1.4 Gyro-compass heading repeater ¹
1.5 Gyro-compass bearing repeater ¹
1.6 Heading or track control system ¹
1.7 Pelorus or compass bearing device ¹
1.8 Means of correcting heading and bearings
1.9 Transmitting heading device (THD) ¹
2.1 Nautical charts/Electronic chart display and information system (ECDIS) ^{2, 1}
2.2 Back-up arrangements for ECDIS
2.3 Nautical publications
2.4 Back-up arrangements for electronic nautical publications
3.1 Receiver for a global navigation satellite system/terrestrial radionavigation system ^{2, 1}
3.2 9 GHz radar ¹
3.3 Second radar (3 GHz/9 GHz ²) ¹
3.4 Automatic radar plotting aid (ARPA) ¹
3.5 Automatic tracking aid
3.6 Second automatic tracking aid
3.7 Electronic plotting aid ¹
4.1 Automatic identification system (AIS)
4.2 Long-range identification tracking system
5.1 Voyage data recorder (VDR)
5.2 Simplified voyage data recorder (S-VDR) ¹
6.1 Speed and distance measuring device (through the water) ¹
6.2 Speed and distance measuring device (over the ground in the forward and athwartship direction) ¹
7 Echo-sounding device ¹

¹ Alternative means of meeting this requirement are permitted under regulation V/19. In case of other means they shall be specified.

² Delete as appropriate.

5 Details of navigational systems and equipment (continued)

Item	Actual provision
8.1 Rudder, propeller, thrust, pitch and operational mode indicator ¹
8.2 Rate-of-turn indicator ¹
9 Sound reception system ¹
10 Telephone to emergency steering position ¹
11 Daylight signaling lamp ¹
12 Radar reflector ¹
13 International Code of Signals
14 IAMSAR Manual, Volume III

THIS IS TO CERTIFY that this Record is correct in all respects

Issued at

.....
(Place of issue of the record)

.....
(Date of issue)

.....
(Signature of duly authorized official issuing the record)

(Seal or stamp of the issuing authority, as appropriate)

¹ Alternative means of meeting this requirement are permitted under regulation V/19. In case of other means they shall be specified.



EXEMPTION CERTIFICATE

Issued under the provisions of the
INTERNATIONAL CONVENTION FOR THE SAFETY OF LIFE
AT SEA, 1974, as modified by the Protocol of 1998 relating thereto

under the authority of the Government of

The Kingdom of Denmark

by **DANISH MARITIME AUTHORITY**

Particulars of ship

Name of ship

Distinctive number or letters

Port of registry

Gross tonnage

IMO Number

THIS IS TO CERTIFY:

That the ship is, under the authority conferred by regulation
of the Convention, exempted from the requirements of
..... of the Convention.

Conditions, if any, on which the Exemption Certificate is granted:

.....
.....

Voyages, if any, for which the Exemption Certificate is granted:

.....

This certificate is valid until subject to
the Certificate, to which this certificate
is attached, remaining valid.

Issued at
(Place of issue of certificate)

..... (Date of issue) (Signature of authorized official issuing the certificate)

(Seal or stamp of the issuing authority, as appropriate)

Endorsement to extend the certificate if valid for less than 5 years where regulation I/14(c) applies

This certificate shall, in accordance with regulation I/14(c) of the Convention, be accepted as valid until subject to the Certificate, to which this certificate is attached, remaining valid.

Signed:
(Signature of authorized official)

Place:

Date:

(Seal or stamp of the issuing authority, as appropriate)

Endorsement where the renewal survey has been completed and regulation I/14(d) applies

This certificate shall, in accordance with regulation I/14(d) of the Convention, be accepted as valid until subject to the Certificate, to which this certificate is attached, remaining valid.

Signed:
(Signature of authorized official)

Place:

Date:

(Seal or stamp of the issuing authority, as appropriate)

Endorsement to extend the validity of the certificate until reaching the port of survey or a period of grace where regulation I/14(e) or I/14(f) applies

This certificate shall, in accordance with regulation I/14(e)/I/14(f)¹ of the Convention, be accepted as valid until subject to the Certificate, to which this certificate is attached, remaining valid.

Signed:
(Signature of authorized official)

Place:

Date:

(Seal or stamp of the issuing authority, as appropriate)

¹ Delete as appropriate.



NUCLEAR PASSENGER SHIP SAFETY CERTIFICATE

This certificate shall be supplemented by a Record of Equipment (Form PNUC)
for $\frac{\text{an}^*}{\text{a short}}$ international voyage

Issued under the provisions of the
INTERNATIONAL CONVENTION FOR THE SAFETY OF LIFE AT SEA, 1974,
as modified by the Protocol of 1988 relating thereto

under the authority of the Government of

The Kingdom of Denmark

by **DANISH MARITIME AUTHORITY**

Particulars of ship¹

Name of ship

Distinctive number or letters

Port of registry

Gross tonnage

Sea areas in which ship is certified
to operate (regulation IV/2)

IMO Number

Date on which keel was laid or ship was at a similar stage of
construction or, where applicable, date on which work for a
conversion or an alteration or modification of a major
character was commenced

* Delete as appropriate.

¹ Alternatively, the particulars of the ship may be placed horizontally in boxes.

THIS IS TO CERTIFY:

1. That the ship has been surveyed in accordance with the requirements of regulation VIII/9 of the Convention.
2. That the ship, being a nuclear ship, complied with all the requirements of chapter VIII of the convention and conformed to the Safety Assessment approved for the ship; and that:
 - 2.1 the ship complied with the requirements of the Convention as regards:
 - .1 the structure, main and auxiliary machinery, boilers and other pressure vessels, including the nuclear propulsion plant and the collision protective structure;
 - .2 the watertight subdivision arrangements and details;
 - .3 the following subdivision load lines;

Subdivision load lines assigned and marked on the ship's side at amidships (regulations II-1/18 ²)	Freeboard	To apply when the spaces in which passengers are carried include the following alternative spaces
P.1
P.2
P.3

- 2.2 the ship complied with the requirements of the Convention as regards structural fire protection, fire safety systems and appliances and fire control plans;
- 2.3 the ship complied with the requirements of the Convention as regards radiation protection systems and equipment;
- 2.4 the life-saving appliances and the equipment of the lifeboats, life rafts and rescue boats were provided in accordance with the requirements of the Convention;
- 2.5 the ship was provided with a line-throwing appliance and radio installations used in life-saving appliances in accordance with the requirements of the Convention;

² For ships constructed before 1 January 2009, the applicable subdivision notation “C.1, C.2 and C.3” should be used.

- 2.6 the ship complied with the requirements of the Convention as regards radio installations;
- 2.7 the functioning of the radio installation used in life-saving appliances complied with the requirements of the Convention;
- 2.8 the ship complied with the requirements of the Convention as regards shipborne navigational equipment, means of embarkation for pilots and nautical publications;
- 2.9 the ship was provided with lights, shapes, means of making sound signals and distress signals, in accordance with the requirements of the Convention and the International Regulations for Preventing Collisions at Sea in force;
- 2.10. in all other respects the ship complied with the relevant requirements of the Convention.
- 2.11. the ship was/was not¹ subjected to an alternative design and arrangements in pursuance of regulation II-2/17 of the Convention
- 2.12 a Document of approval of alternative design and arrangements for fire safety is/is not¹ appended to this Certificate

This certificate is valid until

Completion date of the survey on which this certificate is based

 (dd/mm/yyyy)

Issued at
 (Place of issue of certificate)

.....
 (Date of issue)

.....
 (Signature of authorized official issuing the certificate)

(Seal or stamp of the issuing authority, as appropriate)

¹ Delete as appropriate.



*RECORD OF EQUIPMENT FOR THE
NUCLEAR PASSENGER SHIP SAFETY CERTIFICATE (Form PNUC)*

This Record shall be permanently attached to the
Nuclear Passenger Ship Safety Certificate

**RECORD OF EQUIPMENT FOR COMPLIANCE
WITH THE INTERNATIONAL CONVENTION
FOR THE SAFETY OF LIFE AT SEA, 1974
as modified by the Protocol of 1988 relating thereto**

1 Particulars of ship

Name of ship

Distinctive number or letters

Number of passengers for which
certified

Minimum number of persons with
required qualifications to operate the
radio installations

2 Details of life-saving appliances

1	Total number of persons for which life-saving appliances are provided	
		Port side	Starboard side
2	Total numbers of lifeboats
2.1	Total numbers of persons accommodated by them
2.2	Number of partially enclosed lifeboats (regulation III/2 1 and LSA Code, section 4.5)
2.3	Number of totally enclosed lifeboats (regulation III/2 1 and LSA Code, section 4.6)
2.4	Other lifeboats
2.4.1	Number
2.5.2	Type

2 Details of life-saving appliances (continued)

3	Number of motor lifeboats included in the total lifeboats shown above
3.1	Number of lifeboats fitted with searchlights
4.	Number of rescue boats
4.1	Number of boats which are included in the total lifeboats shown above
5	Liferafts
5.1	Those for which approved launching appliances are required
5.1.1	Number of liferafts
5.1.2	Number of persons accommodated by them
5.2	Those for which approved launching appliances are not required
5.2.1	Number of liferafts
5.2.2	Number of persons accommodated by them
6	Buoyant apparatus
6.1	Number of apparatus
6.2	Number of persons capable of being supported
7	Number of lifebuoys
8	Number of lifejackets
9	Immersion suits
9.1	Total number
9.2	Number of suits complying with the requirements for lifejackets
10	Number of thermal protective aids ¹
11	Radio installations used in life-saving appliances
11.1	Number of search and rescue locating devices
11.1.1	Radar search and rescue transponders (SART)
11.1.2	AIS search and rescue transmitters (AIS-SART)
11.2	Number of two-way VHF radiotelephone apparatus

¹ Excluding those required by LSA Code paragraphs 4.1.5.1.24, 4.4.8.31 and 5.1.2.2.13.

3 Details of radio facilities

Item	Actual provision
1 Primary systems
1.1 VHF radio installation
1.1.1 DSC encoder
1.1.2 DSC watch receiver
1.1.3 Radiotelephony
1.2 MF radio installation
1.2.1 DSC encoder
1.2.2 DSC watch receiver
1.2.3 Radiotelephony
1.3 MF/HF radio installation
1.3.1 DSC encoder
1.3.2 DSC watch receiver
1.3.3 Radiotelephony
1.3.4 Direct-printing radiotelegraphy
1.4 INMARSAT ship earth station
2 Secondary means of alerting
3 Facilities for reception of maritime safety information
3.1 NAVTEX receiver
3.2 EGC receiver
3.3 HF direct-printing radiotelegraph receiver
4 Satellite EPIRB
4.1 COSPASS-SARSAT
4.2 INMARSAT
5 VHF EPIRB
6 Ship's search and rescue locating device
6.1 Radar search and rescue transponder (SART)
6.2 AIS search and rescue transmitter (AIS-SART)

4 *Methods used to ensure availability of radio facilities* (regulations IV/15.6 and 15.7)

- 4.1 Duplication of equipment
- 4.2 Shore-based maintenance
- 4.3 At-sea maintenance capability

5 *Details of navigational systems and equipment*

Item	Actual provision
1.1 Standard magnetic compass ¹
1.2 Spare magnetic compass ¹
1.3 Gyro-compass ¹
1.4 Gyro-compass heading repeater ¹
1.5 Gyro-compass bearing repeater ¹
1.6 Heading or track control system ¹
1.7 Pelorus or compass bearing device ¹
1.8 Means of correcting heading and bearings
1.9 Transmitting heading device (THD) ¹
2.1 Nautical charts/Electronic chart display and information system (ECDIS) ^{2, 1}
2.2 Back-up arrangements for ECDIS
2.3 Nautical publications
2.4 Back-up arrangements for electronic nautical publications
3.1 Receiver for a global navigation satellite system/terrestrial radionavigation system ^{2, 1}
3.2 9 GHz radar ¹
3.3 Second radar (3 GHz/9 GHz ²) ¹
3.4 Automatic radar plotting aid (ARPA) ¹
3.5 Automatic tracking aid
3.6 Second automatic tracking aid
3.7 Electronic plotting aid ¹
4 Automatic identification system (AIS)

¹ Alternative means of meeting this requirement are permitted under regulation V/19. In case of other means they shall be specified.

² Delete as appropriate.

5 Details of navigational systems and equipment (continued)

Item	Actual provision
5 Voyage data recorder (VDR)
6.1 Speed and distance measuring device (through the water) ¹
6.2 Speed and distance measuring device (over the ground in the forward and athwartship direction) ¹
7 Echo-sounding device ¹
8.1 Rudder, propeller, thrust, pitch and operational mode indicator ¹
8.2 Rate-of-turn indicator ¹
9 Sound reception system ¹
10 Telephone to emergency steering position ¹
11 Daylight signaling lamp ¹
12 Radar reflector ¹
13 International Code of Signals
14 IAMSAR Manual, Volume III

THIS IS TO CERTIFY that this Record is correct in all respects

Issued at

.....
(Place of issue of the Record)

.....
(Date of issue)

.....
(Signature of authorized official issuing the Record)

(Seal or stamp of the issuing authority, as appropriate)

¹ Alternative means of meeting this requirement are permitted under regulation V/19. In case of other means they shall be specified.



NUCLEAR CARGO SHIP SAFETY CERTIFICATE

This certificate shall be supplemented by a Record of Equipment (Form CNUC)

Issued under the provisions of the
INTERNATIONAL CONVENTION FOR THE SAFETY OF LIFE AT SEA, 1974,
as modified by the Protocol of 1988 relating thereto

under the authority of the Government of

The Kingdom of Denmark

by

DANISH MARITIME AUTHORITY

Particulars of ship

Name of ship

Distinctive number or letters

Port of registry

Gross tonnage

Deadweight of ship (metric tons)¹

Length of ship (regulation III/3.12)

Sea areas in which ship is certified to
operate (regulation IV/2)

IMO Number

Type of ship²

Bulk carrier

Oil tanker

Chemical tanker

Gas carrier

Cargo ship other than any of the above

Date on which keel was laid or ship was at a similar stage of
construction or, where applicable, date on which work for an
alteration or modification of a major character was commenced

¹ For oil tankers, chemical tankers and gas carriers only.

² Delete as appropriate.

THIS IS TO CERTIFY:

1. That the ship has been surveyed in accordance with the requirements of regulation VIII/9 of the Convention.
2. That the ship, being a nuclear ship, complied with all the requirements of chapter VIII of the Convention and conformed to the safety Assessment approved for the ship; and that:
 - 2.1 the condition of the structure, machinery and equipment as defined in regulation I/10 (as applicable to comply with regulation VIII/9), including the nuclear propulsion plant and the collision protective structure, was satisfactory and the ship complied with the relevant requirements of chapter II-1 and chapter II-2 of the Convention (other than those relating to fire safety systems and appliances and fire control plans);
 - 2.2 the ship complied with the requirements of the Convention as regards fire safety systems and appliances and fire control plans;
 - 2.3 the life-saving appliances and the equipment of the lifeboats, liferafts and rescue boats were provided in accordance with the requirements of the Convention;
 - 2.4 the ship was provided with a line-throwing appliance and radio installations used in life-saving appliances in accordance with the requirements of the Convention;
 - 2.5 the ship complied with the requirements of the Convention as regards radio installations;
 - 2.6 the functioning of the radio installation used in life-saving appliances complied with the requirements of the Convention;
 - 2.7 the ship complied with the requirements of the Convention as regards shipborne navigational equipment, means of embarkation for pilots and nautical publications;
 - 2.8 the ship was provided with lights, shapes, means of making sound signals and distress signals, in accordance with the requirements of the Convention and the International Regulations for Preventing Collisions at Sea in force;
 - 2.9 in all other respects the ship complied with the relevant requirements of the regulations, so far as these apply thereto.
 - 2.10 the ship was/was not/¹ subjected to an alternative design and arrangements in pursuance of regulation II-2/17 of the Convention;
 - 2.11 a Document of approval of alternative design and arrangements for fire safety is/is not³ appended to this Certificate.

¹ Delete as appropriate.

This certificate is valid until

Completion date of the survey on
which this certificate is based
(dd/mm/yyyy)

Issued at
(Place of issue of certificate)

.....
(Date of issue)

.....
(Signature of authorized official issuing the certificate)

(Seal or stamp of the issuing authority, as appropriate)

*RECORD OF EQUIPMENT FOR THE
CARGO SHIP SAFETY CERTIFICATE (Form CNUC)*

This Record shall be permanently attached to the
Nuclear Cargo Ship Safety Certificate

**RECORD OF EQUIPMENT FOR COMPLIANCE
WITH THE INTERNATIONAL CONVENTION
FOR THE SAFETY OF LIFE AT SEA, 1974
as modified by the Protocol of 1988 relating thereto**

1 Particulars of ship

Name of ship

Distinctive number or letters

Minimum number of persons with required
qualifications to operate the radio installations

2 Details of life-saving appliances

1	Total number of persons for which life-saving appliances are provided	
		Port side	Starboard side
2	Total numbers of lifeboats
2.1	Total numbers of persons accommodated by them
2.2	Number of totally enclosed lifeboats (regulation III/3 1 and LSA Code section 4.6)
2.3	Number of lifeboats with a self contained air support system (regulation III/3 1 and LSA Code section 4.8)
2.4	Number of fire-protected lifeboats (regulation III/3 1 and LSA Code section 4.9)
2.5	Other lifeboats
2.5.1	Number
2.5.2	Type
2.6	Number of free-fall lifeboats
2.6.1	Totally enclosed (regulation III/3 1 and LSA Code section 4.7)
2.6.2	Self-contained (regulation III/3 1 and LSA Code section 4.8)
2.6.3	Fire-protected (regulation II/31 and LSA Code section 4.9)

2 *Details of life-saving appliances (continued)*

3	Number of motor lifeboats included in the total lifeboats shown above
3.1	Number of lifeboats fitted with searchlights
4.	Number of rescue boats
4.1	Number of boats which are included in the total lifeboats shown above
5	Liferafts
5.1	Those for which approved launching appliances are required
5.1.1	Number of liferafts
5.1.2	Number of persons accommodated by them
5.2	Those for which approved launching appliances are not required
5.2.1	Number of liferafts
5.2.2	Number of persons accommodated by them
5.3	Number of liferafts required by regulation III/31.1.4
6	Number of lifebuoys
7	Number of lifejackets
8	Immersion suits
8.1	Total number
8.2	Number of suits complying with the requirements for lifejackets
9	Radio installations used in life-saving appliances
9.1	Number of search and rescue locating devices
9.1.1	Radar search and rescue transponders (SART)
9.1.2	AIS search and rescue transmitters (AIS-SART)
9.2	Number of two-way VHF Radiotelephone apparatus

3 *Details of radio facilities*

Item	Actual provision
1 Primary systems
1.1 VHF radio installation
1.1.1 DSC encoder
1.1.2 DSC watch receiver
1.1.3 Radiotelephony
1.2 MF radio installation
1.2.1 DSC encoder
1.2.2 DSC watch receiver
1.2.3 Radiotelephony
1.3 MF/HF radio installation
1.3.1 DSC encoder
1.3.2 DSC watch receiver
1.3.3 Radiotelephony
1.3.4 Direct-printing radiotelegraphy
1.4 INMARSAT ship earth station
2 Secondary means of alerting
3 Facilities for reception of maritime safety information
3.1 NAVTEX receiver
3.2 EGC receiver
3.3 HF direct-printing radiotelegraph receiver
4 Satellite EPIRB
4.1 COSPASS-SARSAT
4.2 INMARSAT
5 VHF EPIRB
6 Ship's search and rescue locating device
6.1 Radar search and rescue transponder (SART)
6.2 AIS search and rescue transmitter (AIS-SART)

4 *Methods used to ensure availability of radio facilities (regulations IV/15.6 and 15.7)*

4.1 Duplication of equipment
4.2 Shore based maintenance
4.3 At-sea maintenance capability

5 Details of navigational systems and equipment

Item	Actual provision
1.1 Standard magnetic compass ¹
1.2 Spare magnetic compass ¹
1.3 Gyro-compass ¹
1.4 Gyro-compass heading repeater ¹
1.5 Gyro-compass bearing repeater ¹
1.6 Heading or track control system ¹
1.7 Pelorus or compass bearing device ¹
1.8 Means of correcting heading and bearings
1.9 Transmitting heading device (THD) ¹
2.1 Nautical charts/Electronic chart display and information system (ECDIS) ^{2, 1}
2.2 Back-up arrangements for ECDIS
2.3 Nautical publications
2.4 Back-up arrangements for electronic nautical publications
3.1 Receiver for a global navigation satellite system/terrestrial radionavigation system ^{2, 1}
3.2 9 GHz radar ¹
3.3 Second radar (3 GHz/9 GHz ²) ¹
3.4 Automatic radar plotting aid (ARPA) ¹
3.5 Automatic tracking aid
3.6 Second automatic tracking aid
3.7 Electronic plotting aid ¹
4 Automatic identification system (AIS)
5 Voyage data recorder (VDR)
6.1 Speed and distance measuring device (through the water) ¹
6.2 Speed and distance measuring device (over the ground in the forward and athwartship direction) ¹
6.3 Echo-sounding device ¹

¹ Alternative means of meeting this requirement are permitted under regulation V/19. In case of other means they shall be specified.

² Delete as appropriate.

5 Details of navigational systems and equipment (continued)

Item	Actual provision
7.1 Rudder, propeller, thrust, pitch and operational mode indicator ¹
7.2 Rate-of-turn indicator ¹
8 Sound reception system ¹
9 Telephone to emergency steering position ¹
10 Daylight signaling lamp ¹
11 Radar reflector ¹
12 International Code of Signals
12 IAMSAR Manual Volume III	

THIS IS TO CERTIFY that this Record is correct in all respects

Issued at

.....
(Place of issue of the record)

.....
(Date of issue)

.....
(Signature of duly authorized official issuing the record)

(Seal or stamp of the issuing authority, as appropriate)

¹ Alternative means of meeting this requirement are permitted under regulation V/19. In case of other means they shall be specified.



INTERNATIONAL SHIP SECURITY CERTIFICATE

Certificate number: Issued under the provisions of
the

INTERNATIONAL CODE FOR THE SECURITY OF SHIPS AND OF PORT FACILITIES (ISPS CODE)

Under the authority of the Government of the Kingdom of Denmark

by **DANISH MARITIME AUTHORITY**

Name of ship

Distinctive number or letters

Port of registry

Type of ship

Gross tonnage (According to footnotes)

IMO Number

Name and address of the Company

THIS IS TO CERTIFY:

1. that the security system and any associated security equipment of the ship has been verified in accordance with section 19.1 of part A of the ISPS Code;
2. that the verification showed that the security system and any associated security equipment of the ship is in all respects satisfactory and that the ship complies with the applicable requirements of chapter XI-2 of the Convention and part A of the ISPS Code;
3. that the ship is provided with an approved ship security plan

Date of initial / renewal verification on which this Certificate is based

This Certificate is valid until

subject to verifications in accordance with section 19.1.1 of part A of the ISPS Code.

Issued at _____
(Place of issue of Certificate)

Date of issue _____
(Signature of the duly authorized official issuing the Certificate)

(Seal or stamp of issuing authority, as appropriate)

¹ The above gross tonnage has been determined in accordance with the International Convention on Tonnage Measurement of Ships, 1969.

² The above gross tonnage has been determined by the authorities of the Administration in accordance with the national tonnage rules which were in force prior to the coming into force for existing ships of the International Convention on Tonnage Measurement of Ships, 1969.

ENDORSEMENT FOR INTERMEDIATE VERIFICATION

THIS IS TO CERTIFY that at an intermediate verification required by section 19.1.1 of part A of the ISPS Code the ship was found to comply with the relevant provisions of chapter XI-2 of the Convention and part A of the ISPS Code.

Intermediate verification

Signed: _____
(Signature of authorized official)

Place: _____

(Seal or stamp of the authority, as appropriate)

Date: _____

ENDORSEMENT FOR ADDITIONAL VERIFICATIONS*

Additional verification

Signed: _____
(Signature of authorized official)

Place: _____

(Seal or stamp of the authority, as appropriate)

Date: _____

Additional verification

Signed: _____
(Signature of authorized official)

Place: _____

(Seal or stamp of the authority, as appropriate)

Date: _____

Additional verification

Signed: _____
(Signature of authorized official)

Place: _____

(Seal or stamp of the authority, as appropriate)

Date: _____

* This part of the certificate shall be adapted by the Administration to indicate whether it has established additional verifications as provided for in section 19.1.1.4.

ADDITIONAL VERIFICATION IN ACCORDANCE WITH SECTION A/19.3.7.2 OF THE ISPS CODE

THIS IS TO CERTIFY that at an additional verification required by section 19.3.7.2. of part A of the ISPS Code the ship was found to comply with the relevant provisions of chapter XI-2 of the Convention and part A of the ISPS Code.

Signed: _____
(Signature of authorized official)

Place: _____

(Seal or stamp of the authority, as appropriate)

Date: _____

ENDORSEMENT TO EXTEND THE CERTIFICATE IF VALID FOR LESS THAN 5 YEARS WHERE SECTION A/19.3.3 OF THE ISPS CODE APPLIES

The ship complies with the relevant provisions of part A of the ISPS Code, and the Certificate shall, in accordance with section 19.3.3 of part A of the ISPS Code, be accepted as valid until:

Signed: _____
(Signature of authorized official)

Place: _____

(Seal or stamp of the authority, as appropriate)

Date: _____

ENDORSEMENT WHERE THE RENEWAL VERIFICATION HAS BEEN COMPLETED AND SECTION A/19.3.4 OF THE ISPS CODE APPLIES

The ship complies with the relevant provisions of part A of the ISPS Code, and the Certificate shall, in accordance with section 19.3.4 of part A of the ISPS Code, be accepted as valid until:

Signed: _____
(Signature of authorized official)

Place: _____

(Seal or stamp of the authority, as appropriate)

Date: _____

ENDORSEMENT TO EXTEND THE VALIDITY OF THE CERTIFICATE UNTIL REACHING THE PORT OF VERIFICATION WHERE SECTION A/19.3.5 OF THE ISPS CODE APPLIES OR FOR A PERIOD OF GRACE WHERE SECTION A/19.3.6 OF THE ISPS CODE APPLIES

This Certificate shall, in accordance with section 19.3.5 / 19.3.6* of Part A of the ISPS Code, be

accepted as valid until _____

Signed: _____
(Signature of authorized official)

Place: _____

(Seal or stamp of the authority, as appropriate)

Date: _____

ENDORSEMENT FOR ADVANCEMENT OF EXPIRY DATE WHERE SECTION A/19.3.7.1 OF THE ISPS CODE APPLIES

In accordance with section 19.3.7.1 of part A of the ISPS Code, the new expiry date** is

Signed: _____
(Signature of authorized official)

Place: _____

(Seal or stamp of the authority, as appropriate)

Date: _____

* Delete as appropriate.

** In case of completion of this part of the Certificate, the expiry date shown on the front of the Certificate shall also be amended accordingly.



INTERIM INTERNATIONAL SHIP SECURITY CERTIFICATE

Certificate number: **Issued under the provisions of
the**

**INTERNATIONAL CODE FOR THE SECURITY OF SHIPS AND OF PORT FACILITIES
(ISPS CODE)**

Under the authority of the Government of the Kingdom of Denmark

by **DANISH MARITIME AUTHORITY**

Name of ship

Distinctive number or letters

Port of registry

Type of ship

Gross tonnage (According to footnotes)

IMO Number

Name and address of the Company

Is this a subsequent, consecutive interim certificate?

If Yes, date of issue of initial interim certificate

THIS IS TO CERTIFY THAT the requirements of section A/19.4.2 of the ISPS Code have been complied with.

This certificate is issued pursuant to section A/19.4 of the ISPS Code

This certificate is valid until

subject to verifications in accordance with section 19.1.1 of part A of the ISPS Code.

Issued at _____
(place of issue of Certificate)

Date of issue _____
(Signature of the duly authorized official issuing the Certificate)

(Seal or stamp of issuing authority, as appropriate)

¹ The above gross tonnage has been determined in accordance with the International Convention on Tonnage Measurement of Ships, 1969.

² The above gross tonnage has been determined by the authorities of the Administration in accordance with the national tonnage rules, which were in force prior to the coming into force for existing ships of the International Convention on Tonnage Measurement of Ships, 1969.



EVIDENCE OF SHIP COMPLIANCE
CONCERNING
DAMAGE STABILITY OF RO-RO PASSENGER SHIPS

Issued under the provisions of the
REGIONAL AGREEMENT CONCERNING SPECIFIC STABILITY REQUIREMENTS FOR RO-RO PASSENGER SHIPS UNDERTAKING REGULAR SCHEDULED INTERNATIONAL VOYAGES BETWEEN, OR TO OR FROM DESIGNATED PORTS IN NORTH WEST EUROPE AND THE BALTIC SEA (STOCKHOLM AGREEMENT), AND DIRECTIVE 2003/25/EC.

**under the authority of the Government of the Kingdom of Denmark
by DANISH MARITIME AUTHORITY**

Particulars of ship

Name of ship _____

Distinctive number or letters _____

Port of registry _____

IMO Number _____

Standard of subdivision*** _____

Date on which keel was laid / date of major rebuilding _____

Draught at deepest subdivision load line [m] _____

The SOLAS regulations which apply **SOLAS 90** standard *

Number of persons to be carried and/or number of passengers to be carried _____

Water on the deck investigations according to the Stockholm Agreement, applied by: _____

either Calculations:

- **Significant wave heights Hs** [m]** _____

or Model tests method (for the worst damage case):

- **Significant wave heights Hs** [m]** _____

Ships carrying 400 persons or more shall prove compliance with SOLAS Reg.II-1/8-2 not later than the first yearly inspection following the latest date as prescribed in this regulation: _____

This is to certify that the ship's Damage Stability Characteristics comply with the Criteria specified in the Stockholm Agreement between European Administrations on Ferry Survivability dated 29 April 1996, and in Directive 2003/25/EC.

Issued at _____

(Date)

(Signature of authorized official, issuing the evidence)

* SOLAS 74 with amendments in force on 29 April 1990.
 ** which is not exceeded by a probability of more than 10% of the year.
 *** One compartment standard = 1, two compartment standard = 2.



INTERNATIONAL LOAD LINE CERTIFICATE

Issued under the provisions of the
INTERNATIONAL CONVENTION ON LOAD LINES, 1966,
as modified by the Protocol of 1988 relating thereto
under the authority of the Government of
DENMARK

by **DANISH MARITIME AUTHORITY**

Particulars of ship

Name of ship
Distinctive number or letters
Port of registry
Length (L) as defined in article 2(8) (in metres)
IMO Number

Freeboard assigned as:¹

- A new ship
- An existing ship

Type of ship:¹

- Type 'A'
- Type 'B'
- Type 'B' with reduced freeboard
- Type 'B' with increased freeboard

¹ Delete as appropriate.

Freeboard from deck line²

Load line²

Tropical mm (T) mm above (S)
Summer mm (S)	Upper edge of line through centre of ring
Winter mm (W) mm below (S)
Winter North Atlantic mm (WNA) mm below (S)
Timber tropical mm (LT) mm above (LS)
Timber summer mm (LS) mm above (S)
Timber winter mm (LW) mm below (LS)
Timber winter North Atlantic mm (LWNA) mm below (LS)

Allowance for fresh water for all freeboards other than timber mm.

For timber freeboards mm.

The upper edge of the deck line from which these freeboards are measured is mm
 deck at side.

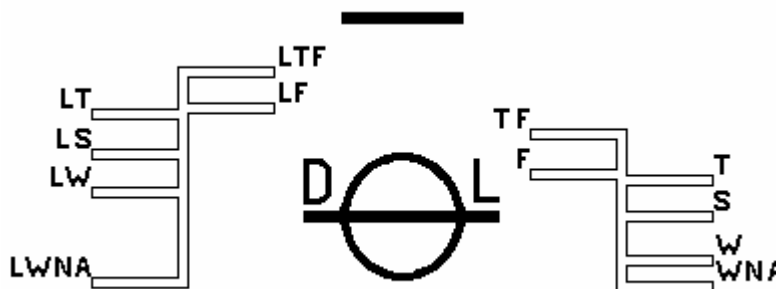

² Freeboards and load lines which are not applicable need not be entered on the certificate. Subdivision load lines may be entered on the certificate on a voluntary basis.

THIS IS TO CERTIFY:

1. That the ship has been surveyed in accordance with the requirements of article 14 of the Convention
2. That the survey showed that the freeboards have been assigned and load lines shown above have been marked in accordance with the Convention.

This certificate is valid until³ subject to annual surveys in accordance with article 14(1)(c) of the Convention.

Issued at
(Place of issue of the certificate)

.....
(Date of issue)
(Signature of authorized official issuing the certificate)

(Seal or stamp of the authority, as appropriate)

- NOTES:
1. When a ship departs from a port situated on a river or inland waters, deeper loading shall be permitted corresponding to the weight of fuel and all other materials required for consumption between the point of departure and the sea.
 2. When a ship is in fresh water of unit density the appropriate load line may be submerged by amount of fresh water allowance shown above. Where the density is other than unity, an allowance shall be made proportional to the difference between 1.025 and the actual density.

³ Insert the date of expiry as specified by the Administration in accordance with the article 19(1) of the Convention. The day and month of this date correspond to the anniversary date as defined in article 2(9) of the convention, unless amended in accordance with article 19(8) of the Convention.

Endorsement for annual surveys

THIS IS TO CERTIFY that, at an annual survey required by article 14(1)(c) of the Convention, the ship was found to comply with the relevant requirements of the Convention.

Annual survey: Signed:
(Signature of authorized official)

Place:

Date:

(Seal or stamp of the authority, as appropriate)

Annual survey: Signed:
(Signature of authorized official)

Place:

Date:

(Seal or stamp of the authority, as appropriate)

Annual survey: Signed:
(Signature of authorized official)

Place:

Date:

(Seal or stamp of the authority, as appropriate)

Annual survey: Signed:
(Signature of authorized official)

Place:

Date:

(Seal or stamp of the authority, as appropriate)

Annual survey in accordance with article 19(8)(c)

THIS IS TO CERTIFY that, at a survey required by article 19(8)(c) of the Convention, the ship was found to comply with the relevant requirements of the Convention.

Signed:
(Signature of authorized official)

Place:

Date:

(Seal or stamp of the authority, as appropriate)

Endorsement to extend the certificate if valid for less than 5 years where article 19(3) applies

The ship complies with the relevant requirements of the Convention, and this certificate shall, in accordance with article 19(3) of the Convention, be accepted as valid until

Signed:
(Signature of authorized official)

Place:

Date:

(Seal or stamp of the authority, as appropriate)

Endorsement where the renewal survey has been completed and article 19(4) applies:

The ship complies with the relevant requirements of the Convention, and this certificate shall, in accordance with article 19(4) of the Convention, be accepted as valid until

Signed:
(Signature of authorized official)

Place:

Date:

(Seal or stamp of the authority, as appropriate)

Endorsement to extend the validity of the certificate until reaching the port of survey or for period of grace where article 19(5) or 19(6) applies

This certificate shall, in accordance with article 19(5) or 19(6)³ of the Convention, be accepted as valid until

Signed:
(Signature of authorized official)

Place:

Date:

(Seal or stamp of the authority, as appropriate)

Endorsement for advancement of anniversary date where article 19(8) applies

In accordance with article 19(8) of the Convention the new anniversary date is

Signed:
(Signature of authorized official)

Place:

Date:

(Seal or stamp of the authority, as appropriate)

In accordance with article 19(8) of the Convention the new anniversary date is

Signed:
(Signature of authorized official)

Place:

Date:

(Seal or stamp of the authority, as appropriate)

³ Delete as appropriate



INTERNATIONAL LOAD LINE EXEMPTION CERTIFICATE

Issued under the provisions of the
INTERNATIONAL CONVENTION ON LOAD LINES, 1966,
as modified by the Protocol of 1988 relating thereto

under the authority of the Government of

DENMARK

by **DANISH MARITIME AUTHORITY**

Particulars of ship

Name of ship

Distinctive number or letters

Port of registry

Length (L) as defined in article 2(8) (in metres)

IMO Number

THIS IS TO CERTIFY:

That the ship is exempted from the provisions of the Convention, under the authority conferred by article 6(2)/6(4)¹ of the Convention referred to above.

The provisions of the Convention from which the ship is exempted under article 6(2) are:

.....
.....
.....

The voyage for which exemption is granted under article 6(4) is:

From:

To:

Conditions, if any, on which the exemption is granted under either article 6(2) or article 6(4):

.....
.....
.....

¹ Delete as appropriate

This certificate is valid until² subject to annual surveys in accordance with article 14(1)(c) of the Convention.

Issued at
(Place of issue the certificate)

.....
(Date of issue)
(Signature of authorized official issuing the certificate)

(Seal or stamp of the authority, as appropriate)

² Insert the date of expiry as specified by the Administration in accordance with the article 19(10) of the Convention. The day and month of this date correspond to the anniversary date as defined in article 2(9) of the Convention, unless amended in accordance with article 19(8) of the Convention.

Endorsement for annual surveys

THIS IS TO CERTIFY that, at an annual survey required by article 14(1)(c) of the Convention, the ship was found to comply with the conditions under which this exemption was granted.

Annual survey: Signed:
(Signature of authorized official)
Place:
Date:
(Seal or stamp of the authority, as appropriate)

Annual survey: Signed:
(Signature of authorized official)
Place:
Date:
(Seal or stamp of the authority, as appropriate)

Annual survey: Signed:
(Signature of authorized official)
Place:
Date:
(Seal or stamp of the authority, as appropriate)

Annual survey: Signed:
(Signature of authorized official)
Place:
Date:
(Seal or stamp of the authority, as appropriate)

Annual survey in accordance with article 19(8)(c)

THIS IS TO CERTIFY that, at a survey in accordance with article 19(8)(c) of the Convention, the ship was found to comply with the relevant requirements of the Convention.

Signed:
(Signature of authorized official)

Place:

Date:

(Seal or stamp of the authority, as appropriate)

Endorsement to extend the certificate if valid for less than 5 years where article 19(3) applies

The ship complies with the relevant requirements of the Convention, and this certificate shall, in accordance with article 19(3) of the Convention, be accepted as valid until

Signed:
(Signature of authorized official)

Place:

Date:

(Seal or stamp of the authority, as appropriate)

Endorsement where the renewal survey has been completed and article 19(4) applies:

The ship complies with the relevant requirements of the Convention, and this certificate shall, in accordance with article 19(4) of the Convention, be accepted as valid until

Signed:
(Signature of authorized official)

Place:

Date:

(Seal or stamp of the authority, as appropriate)

Endorsement to extend the validity of the certificate until reaching the port of survey or for period of grace where article 19(5) or 19(6) applies

This certificate shall, in accordance with article 19(5) or 19(6)³ of the Convention, be accepted as valid until

Signed:
(Signature of authorized official)

Place:

Date:

(Seal or stamp of the authority, as appropriate)

Endorsement for advancement of anniversary date where article 19(8) applies

In accordance with article 19(8) of the Convention, the new anniversary date is

Signed:
(Signature of authorized official)

Place:

Date:

(Seal or stamp of the authority, as appropriate)

In accordance with article 19(8) of the Convention, the new anniversary date is

Signed:
(Signature of authorized official)

Place:

Date:

(Seal or stamp of the authority, as appropriate)

³ Delete as appropriate



Fribordscertifikat

Udstedt af Søfartsstyrelsen
i henhold til bestemmelserne i Meddelelser fra
Søfartsstyrelsen B, kap. B II-5N og Meddelelser fra Søfartsstyrelsen D, kap. II-5.

Skibets navn	Kendings- bogstaver	Kontrol- nummer	Hjemsted	Længde ¹

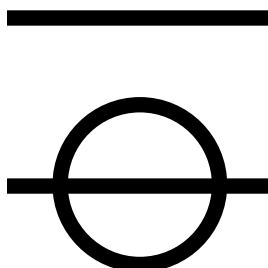

Fribord fra fribordsdæksliniens overkant: mm

Reduktion i ferskvand: mm

Fribordsdækslinien er afmærket udfor:

Certifikatet har gyldighed indtil videre, under forudsætning af, at der ikke ved skibets skrog eller overbygninger foretages sådanne væsentlige forandringer, at de nødvendiggør tildeling af forøget fribord.

Dato

Sted

Underskrift

Stempel

¹ Som angivet i skibets målebrev.

A N N E X 1 C

MARPOL certificates

International Oil Pollution Prevention Certificate (IOPP)

Certifikat om forebyggelse af olieforurening

Record Of Construction And Equipment For Ships Other Than Oil Tankers (Form A)

Udrustningsfortegnelse for andre skibe end olietankere (Form A)

Record Of Construction And Equipment For Oil Tankers (Form B)*

Udrustningsfortegnelse for olietankere (Form B)

International Pollution Prevention Certificate For The Carriage Of Noxious Liquid Substances In Bulk (NLS)

Certifikat om forebyggelse af forurening med skadelige flydende stoffer i bulk

International Sewage Pollution Prevention Certificate (1973)

Certifikat om forebyggelse af forurening med kloakspildevand

International Air Pollution Prevention Certificate (IAPP)

Certifikat om forebyggelse af luftforurening

Record of Construction And Equipment

Supplement to the IAPP certificate

Udrustningsfortegnelse til internationalt certifikat om forebyggelse af luftforurening

* Not used in ships covered by Notice D from the Danish Maritime Authority.



INTERNATIONAL OIL POLLUTION PREVENTION CERTIFICATE¹

(Note: This certificate shall be supplemented by a
Record of Construction and Equipment)

Issued under the Provisions of the
INTERNATIONAL CONVENTION FOR THE PREVENTION OF POLLUTION
FROM SHIPS, 1973,
as modified by the Protocol of 1978 relating thereto, and as amended (hereinafter
referred to as »the Convention«)
under the authority of the Government of:

The Kingdom of Denmark

by

DANISH MARITIME AUTHORITY

Particulars of ship

Name of ship

.....

Distinctive number or letters

.....

Port of registry

.....

Gross tonnage

.....

Deadweight of ship (metric tons)*

.....

IMO Number²

.....

Type of ship**

Oil tanker

Ship other than an oil tanker with cargo tanks coming under regulation 2.2 of Annex I of the
Convention

Ship other than any above

¹ The language of the IOPP Certificate shall be at least English, French or Spanish. If an official language of the issuing country is also used, this shall prevail in case of a dispute or discrepancy.

* For oil tankers.

² Refer to IMO Ship Identification Number Scheme adopted by the Organization by resolution A.600(15).

** Delete as appropriate.

THIS IS TO CERTIFY:

1. That the ship has been surveyed in accordance with regulation 6 of Annex I of the Convention;
and
2. That the survey shows that the structure, equipment, systems, fittings, arrangements and material of the ship and the condition thereof are in all respects satisfactory and that the ship complies with the applicable requirements of Annex I of the Convention.

This certificate is valid until^{***} subject to surveys in accordance with regulation 6 of Annex I of the Convention.

Completion date of the survey on which this certificate is based: (dd/mm/yyyy)

Issued at
(Place of issue of certificate)

(dd/mm/yyyy)
(Date of issue)

.....
(Signature of authorized official issuing the certificate)

(Seal or stamp of the issuing authority, as appropriate)

^{***} Insert the date of expiry as specified by the Administration in accordance with regulation 10.1 of Annex I of the Convention. The day and the month of this date correspond to the anniversary date as defined in regulation 1.27 of Annex I of the Convention, unless amended in accordance with regulation 10.8 of Annex I of the Convention.

Endorsement for annual and intermediate surveys

THIS IS TO CERTIFY that, at a survey required by regulation 6 of Annex I of the Convention, the ship was found to comply with the relevant provisions of the Convention:

Annual survey: Signed:
(Signature of authorized official)

Place:

Date: (dd/mm/yyyy)

(Seal or stamp of the issuing authority, as appropriate)

Annual/Intermediate* survey: Signed:
(Signature of authorized official)

Place:

Date: (dd/mm/yyyy)

(Seal or stamp of the issuing authority, as appropriate)

Annual/Intermediate* survey: Signed:
(Signature of authorized official)

Place:

Date: (dd/mm/yyyy)

(Seal or stamp of the issuing authority, as appropriate)

Annual survey: Signed:
(Signature of authorized official)

Place:

Date: (dd/mm/yyyy)

(Seal or stamp of the issuing authority, as appropriate)

* Delete as appropriate.

Annual/intermediate survey in accordance with regulation 10.8.3

THIS IS TO CERTIFY that, at an annual/intermediate* survey in accordance with regulation 10.8.3 of Annex I of the Convention, the ship was found to comply with the relevant provisions of the Convention:

Signed:
(Signature of authorized official)

Place:

Date: (dd/mm/yyyy)

(Seal or stamp of the issuing authority, as appropriate)

Endorsement to extend the certificate if valid for less than 5 years where regulation 10.3 applies

The ship complies with the relevant provisions of the Convention, and this certificate shall, in accordance with regulation 10.3 of Annex I of the Convention, be accepted as valid until

Signed:
(Signature of authorized official)

Place:

Date: (dd/mm/yyyy)

(Seal or stamp of the issuing authority, as appropriate)

Endorsement where the renewal survey has been completed and regulation 10.4 applies

The ship complies with the relevant provisions of the Convention, and this Certificate shall, in accordance with regulation 10.4 of Annex I of the Convention, be accepted as valid until

Signed:
(Signature of authorized official)

Place:

Date: (dd/mm/yyyy)

(Seal or stamp of the issuing authority, as appropriate)

* Delete as appropriate.

**Endorsement to extend the validity of the Certificate until reaching the port of survey
or a period of grace where regulation 10.5 or 10.6 applies**

This Certificate shall, in accordance with regulation 10.5 or 10.6* of Annex I of the Convention, be
accepted as valid until

Signed:
(Signature of authorized official)

Place:

Date: (dd/mm/yyyy)

(Seal or stamp of the issuing authority, as appropriate)

Endorsement for advancement of anniversary date where regulation 10.8 applies

In accordance with regulation 10.8 of Annex I of the Convention, the new anniversary date
is

Signed:
(Signature of authorized official)

Place:

Date: (dd/mm/yyyy)

(Seal or stamp of the issuing authority, as appropriate)

In accordance with regulation 10.8 of Annex I of the Convention, the new anniversary date
is

Signed:
(Signature of authorized official)

Place:

Date: (dd/mm/yyyy)

(Seal or stamp of the issuing authority, as appropriate)

* Delete as appropriate.



Supplement to the International Oil Pollution Prevention Certificate
(IOPP Certificate)

RECORD OF CONSTRUCTION AND EQUIPMENT FOR SHIPS OTHER THAN OIL TANKERS

in respect of the provisions of Annex I of the
INTERNATIONAL CONVENTION FOR THE PREVENTION OF POLLUTION
FROM SHIPS, 1973,
as modified by the Protocol of 1978 relating thereto
(hereinafter referred to as »the Convention«)

Notes:

1. This form is to be used for the third type of ships as categorized in the IOOP Certificate, i.e. »ships other than any of the above«. For oil tankers and ships other than oil tankers with cargo tanks coming under regulation 2.2 of Annex I of the Convention, Form B shall be used.
2. This Record shall be permanently attached to the IOPP Certificate. The IOPP Certificate shall be available on board the ship at all times.
3. The language of the original Record shall be at least in English, French or Spanish. If an official language of the issuing country is also used, this shall prevail in case of a dispute or discrepancy.
4. Entries in boxes shall be made by inserting either a cross (X) for the answer »yes« and »applicable« or a dash (-) for the answers »no« and »not applicable« as appropriate.
5. Regulations mentioned in this Record refer to regulations of Annex I of the Convention and resolutions refer to those adopted by the International Maritime Organization.

1. Particulars of ship

- 1.1 Name of ship
- 1.2 Distinctive number or letters
- 1.3 Port of registry
- 1.4 Gross tonnage
- 1.5 Date of build:
- 1.5.1 Date of building contract
- 1.5.2 Date on which keel was laid or ship was at a similar stage of construction
- 1.5.3 Date of delivery

- 1.6 Major conversion (if applicable):
- 1.6.1 Date of conversion contract
- 1.6.2 Date on which conversion was commenced
- 1.6.3 Date of completion of conversion
- 1.7. The ship has been accepted by the Administration as a »ship delivered on or before 31 December 1979« under regulation 1.28.1 due to unforeseen delay in delivery
- 2. Equipment for the control of oil discharge from machinery space bilges and oil fuel tanks (regulations 16 and 14)**
- 2.1 Carriage of ballast water in oil fuel tanks:
- 2.1.1 The ship may under normal conditions carry ballast water in oil fuel tanks
- 2.2 Type of filtering equipment fitted:
- 2.2.1 Oil filtering (15 ppm) equipment (regulation 14.6)
- 2.2.2 Oil filtering (15 ppm) equipment with alarm and automatic stopping device (regulation 14.7)
- 2.3 Approval standards* :
- 2.3.1 The separating/filtering system:
- .1 has been approved in accordance with the resolution A.393(X)
- .2 has been approved in accordance with resolution MEPC.60(33)
- .3 has been approved in accordance with resolution A.107(49)
- .4 has been approved in accordance with A.233(VII)
- .5 has been approved in accordance with national standards not based upon resolution A.393(X) or A.233(VII)
- .6 has not been approved
- 2.3.2 The process unit has been approved in accordance with resolution A.444(XI)
- 2.3.3 The oil content meter:
- .1 has been approved in accordance with resolution A.393(X);
- .2 has been approved in accordance with resolution MEPC.60(33).
- .3 has been approved in accordance with resolution MEPC.107(49).

* Refer to the Recommendation on international performance and test specifications of oily-water separating equipment and oil content meters adopted by the Organization on 14 November 1977 by resolution A.393(X), which superseded resolution A.233(VII). Further reference is made to the Guidelines and specifications for pollution prevention equipment for machinery space bilges adopted by the Marine Environment Protection Committee of the Organization by resolution MEPC.60(33), which, effective on 6 July 1993, superseded resolutions A.393(X) and A.444(XI); and to the revised Guidelines and specifications for pollution prevention equipment for machinery spaces of ships adopted by the Marine Environment Protection Committee of the Organization by resolution MEPC.107(49) which, effective on 1 January 2005, superseded resolutions MEPC.60(33), A.393(X) and A.444(XI).

2.4 Maximum throughput of the system is m³/h

2.5 Waiver of regulation 14:

2.5.1 The requirements of regulation 14.1 or 14.2 are waived in respect of the ship in accordance with regulation 14.5.

2.5.1.1 The ship is engaged exclusively on voyages within special area(s):

2.5.1.2 The ship is certified under the International Code of Safety for High-Speed Craft and engaged on a scheduled service with a turn-around time not exceeding 24 hours

2.5.2 The ship is fitted with holding tank(s) for the total retention on board of all oily bilge water as follows:

Tank identification	Tank Location		Volume (m ³)
	Frames (from) – (to)	Lateral Position	
Total volume:			m ³

2.A.1. The ship is required to be constructed according to regulation 12A and complies with the requirements of:

paragraphs 6 and either 7 or 8 (double hull construction)

paragraph 11 (accidental oil fuel outflow performance)

2.A.2 The ship is not required to comply with the requirements of regulation 12A

3. Means for retention and disposal of oil residues (sludge)(regulation 12) and bilge water holding tank(s)*

3.1 The ship is provided with oil residue (sludge) tanks as follows:

Tank identification	Tank Location		Volume (m ³)
	Frames (from) – (to)	Lateral Position	
Total volume:			m ³

3.2 Means for the disposal of residues in addition to the provisions of sludge tanks:

3.2.1 Incinerator for oil residues, capacity l/h

3.2.2 Auxiliary boiler suitable for burning oil residues

3.2.3 Tank for mixing oil residues with fuel, capacity m³

3.2.4 Other acceptable means:

* Bilge water holding tank(s) are not required by the Convention, entries in the table under paragraph 3.3 are voluntary.

3.3 The ship is fitted with holding tank(s) for the retention on board of oily bilge water as follows:

Tank identification	Tank Location		Volume (m ³)
	Frames (from) – (to)	Lateral Position	
Total volume:			m ³

4. Standard discharge connection (regulation 13)

4.1 The ship is provided with a pipeline for the discharge of residues from machinery bilges to reception facilities, fitted with a standard discharge connection in compliance with regulation 13

5. Shipboard oil pollution emergency plan (regulation 37)

5.1 The ship is provided with a shipboard oil pollution emergency plan in accordance with regulation 37

5.2 The ship is provided with a shipboard oil pollution emergency plan in accordance with regulation 37.3

6. Exemption

6.1 Exemption has been granted by the Administration from the requirements of chapters 3 of Annex I of the Convention in accordance with regulation 3.1 on those items listed paragraph(s)

.....

 of this Record

7. Equivalentents (regulation 5)

7.1 Equivalentents have been approved by the Administration for certain requirements of Annex I on those items listed under paragraph(s)

.....

 of this Record

THIS IS TO CERTIFY that this Record is correct in all respects.

Issued at
 (Place of issue of the Record)

..... (Date of issue) (Signature of duly authorized officer issuing the Record)
 (Seal or stamp of issuing authority, as appropriate)



DENMARK

FORM B
(Revised 2007)

Supplement to the International Oil Pollution Prevention Certificate
(IOPP Certificate)

RECORD OF CONSTRUCTION AND EQUIPMENT FOR OIL TANKERS

in respect of the provisions of Annex I of the
INTERNATIONAL CONVENTION FOR THE PREVENTION OF POLLUTION
FROM SHIPS, 1973,
as modified by the Protocol of 1978 relating thereto
(hereinafter referred to as »the Convention«)

Notes:

1. This form is to be used for the first two types of ships as categorized in the IOOP Certificate, i.e. »oil tankers« and »ships other than oil tankers with cargo tanks coming under regulation 2.2 of Annex I of the Convention«. For the third type of ships as categorized in the IOPP Certificate, Form A shall be used.
2. This Record shall be permanently attached to the IOPP Certificate. The IOPP Certificate shall be available on board the ship at all times.
3. The language of the original Record shall be at least in English, French or Spanish. If an official language of the issuing country is also used, this shall prevail in case of a dispute or discrepancy.
4. Entries in boxes shall be made by inserting either a cross (X) for the answer »yes« and »applicable« or a dash (-) for the answers »no« and »not applicable« as appropriate.
5. Unless otherwise stated, regulations mentioned in the Record refer to regulations of Annex I of the Convention and resolutions refer to those adopted by the International Maritime Organization.

1. Particulars of ship

- | | | |
|-----|-------------------------------|----------------------------------|
| 1.1 | Name of ship | |
| 1.2 | Distinctive number or letters | |
| 1.3 | Port of registry | |
| 1.4 | Gross tonnage | |
| 1.5 | Carrying capacity of ship | (m ³) |
| 1.6 | Deadweight of ship | (tonnes) (regulation 1.23) |
| 1.7 | Length of ship | (m) (regulation 1.19) |

- 1.8 Date of build:
- 1.8.1 Date of building contract
- 1.8.2 Date on which keel was laid or ship was at a similar stage of construction
- 1.8.3 Date of delivery
- 1.9 Major conversion (if applicable):
- 1.9.1 Date of conversion contract
- 1.9.2 Date on which conversion was commenced
- 1.9.3 Date of completion of conversion
- 1.10 Unforeseen delay in delivery:
- 1.10.1 The ship has been accepted by the Administration as a » ship delivered on or before 31 December 1979« under regulation 1.28.1 due to unforeseen delay in delivery
- 1.10.2 The ship has been accepted by the administration as an »oil tanker delivered on or before 1 June 1982« under regulation 1.28.3 due to unforeseen delay in delivery
- 1.10.3 The ship is not required to comply with the provisions of regulation 26 due to unforeseen delay in delivery
- 1.11 Type of ship:
- 1.11.1 Crude oil tanker
- 1.11.2 Product carrier
- 1.11.3 Product carrier not carrying fuel oil or heavy diesel oil referred to in regulation 20.2, or lubricating oil
- 1.11.4 Crude oil/product carrier
- 1.11.5 Combination carrier
- 1.11.6 Ship, other than an oil tanker, with cargo tanks coming under regulation 2.2 of Annex I of the Convention
- 1.11.7 Oil tanker dedicated to carriage of product referred to in regulation 2.4
- 1.11.8 The ship, being designated as a »crude oil tanker« operating with COW, is also designated as a »product carrier« operating with CBT, for which a separate IOPP Certificate has also been issued
- 1.11.9 The ship, being designated as a »product carrier« operating with CBT, is also designated as a »crude oil tanker« operating with COW, for which a separate IOPP Certificate has also been issued

2. Equipment for the control of oil discharge from machinery space bilges and oil fuel tanks (regulations 16 and 14)

2.1 Carriage of ballast water in oil fuel tanks:

2.1.1 The ship may under normal conditions carry ballast water in oil fuel tanks

2.2 Type of filtering equipment fitted:

2.2.1 Oil filtering (15 ppm) equipment (regulation 14.6)

2.2.2 Oil filtering (15 ppm) equipment with alarm and automatic stopping device (regulation 14.7)

2.3 Approval standards*:

2.3.1 The separating/filtering system:

.1 has been approved in accordance with the resolution A.393(X)

.2 has been approved in accordance with resolution MEPC.60(33)

.3 has been approved in accordance with resolution MEPC.107(49)

.4 has been approved in accordance with A.233(VII)

.5 has been approved in accordance with national standards not based upon resolution A.393(X) or A.233(VII)

.6 has not been approved

2.3.2 The process unit has been approved in accordance with resolution A.444(XI)

2.3.3 The oil content meter:

.1 has been approved in accordance with resolution A.393(X);

.2 has been approved in accordance with resolution MEPC.60(33).

.3 has been approved in accordance with resolution MEPC.107(49).

2.4 Maximum throughput of the system is m³/h

2.5 Waiver of regulation 14:

2.5.1 The requirements of regulation 14.1 or 14.2 are waived in respect of the ship in accordance with regulation 14.5.

The ship is engaged exclusively on voyages within special area(s):
.....

* Refer to the Recommendation on the international performance and test specifications of oily water separation equipment and oil content meters adopted by the Organization on 14 November 1997 by resolution A.393(X), which superseded resolution A.233(VII). Further reference is made to the Guidelines and specifications for pollution prevention equipment for machinery space bilges adopted by the Marine Environment Protection Committee of the Organization by resolution MEPC.60(33), which, effective on 6 July 1993, superseded resolutions A.393(X) and A.393(XI); and to the revised Guidelines and specifications for pollution prevention equipment for machinery spaces of ships adopted by the Marine Environment Protection Committee of the Organization by resolution MEPC.107(49) which, effective on 1 January 2005, superseded resolutions MEPC.60(33), A.393(X) and A.444(XI)

2.5.2 The ship is fitted with holding tank(s) for the total retention on board of all oily bilge water as follows:

Tank identification	Tank Location		Volume (m ³)
	Frames (from) – (to)	Lateral Position	
Total volume:		 m ³

2.5.3 In lieu of holding tank the ship is provided with arrangements to transfer bilge water to the slop tank.

2.A.1. The ship is required to be constructed according to regulation 12A and complies with the requirements of:

paragraphs 6 and either 7 or 8 (double hull construction)

paragraph 11 (accidental oil fuel outflow performance)

2.A.2 The ship is not required to comply with the requirements of regulation 12A

3. Means for retention and disposal of oil residues (sludge)(regulation 12) and bilge water holding tank(s)*

3.1 The ship is provided with oil residue (sludge) tanks as follows:

Tank identification	Tank Location		Volume (m ³)
	Frames (from) – (to)	Lateral Position	
Total volume:		 m ³

3.2 Means for the disposal of residues in addition to the provisions of sludge tanks:

3.2.1 Incinerator for oil residues, capacity l/h

3.2.2 Auxiliary boiler suitable for burning oil residues

3.2.3 Tank for mixing oil residues with fuel, capacity m³

3.2.4 Other acceptable means:

3.3 The ship is fitted with holding tank(s) for the retention on board of oily bilge water as follows:

* Bilge water holding tank(s) are not required by the Convention, entries in the table under paragraph 3.3 are voluntary.

Tank identification	Tank Location		Volume (m ³)
	Frames (from) – (to)	Lateral Position	
Total volume:			m ³

4. Standard discharge connection (regulation 13)

4.1 The ship is provided with a pipeline for the discharge of residues from machinery bilges to reception facilities, fitted with a standard discharge connection in compliance with regulation 13

5. Construction (regulations 18, 19, 20, 23, 26, 27 and 28)

5.1 In accordance with the requirements of regulation 18, the ship is:

- 5.1.1 required to be provided with SBT, PL an COW
- 5.1.2 required to be provided with SBT and PL
- 5.1.3 required to be provided with SBT
- 5.1.4 required to be provided with SBT and COW
- 5.1.5 required to be provided with SBT and CBT
- 5.1.6 not required to comply with the requirements of regulation 18

5.2 Segregated ballast tanks (SBT):

- 5.2.1 The ship is provided with SBT, in compliance with regulation 18
- 5.2.2 The ship is provided with SBT, in compliance with regulation 18, which are arranged in protective locations (PL) in compliance with regulation 18.12 to 18.15

5.2.3 SBT are distributed as follows:

Tank	Volume (m ³)	Tank	Volume (m ³)

Total volume: m³

5.3 Dedicated clean ballast tanks (CBT):

5.3.1 The ship is provided with CBT in compliance with regulation 18.8, and may operate as a product carrier

5.3.2 CBT are distributed as follows:

Tank	Volume (m ³)	Tank	Volume (m ³)
Total volume:		 m ³

5.3.3 The ship has been supplied with a valid Dedicated Clean Ballast Tank Operation Manual, which is dated

5.3.4 The ship has common piping and pumping arrangements for ballasting the CBT and handling cargo oil

5.3.5 The ship has separate independent piping and pumping arrangements for ballasting the CBT

5.4 Crude oil washing (COW):

5.4.1 The ship is equipped with a COW system in compliance with regulation 33

5.4.2 The ship is equipped with a COW system in compliance with regulation 33 except that the effectiveness of the system has not been confirmed in accordance with regulation 33.1 and paragraph 4.2.10 of the Revised COW Specifications (resolution A.446(XI) as amended by resolution A.497(XII) and A.897(21))

5.4.3 The ship has been supplied with a valid Crude Oil Washing Operation and Equipment Manual, which is dated

5.4.4 The ship is not required to be but is equipped with COW in compliance with the safety aspects of the Revised COW Specifications (resolution A.446(XI) as amended by resolution A.497(XII) and A.897(21))

5.5 Exemption from regulation 18:

5.5.1 The ship is solely engaged in trade between

 in accordance with regulation 2.5 and is therefore exempted from the requirements of regulation 18

5.5.2 The ship is operating with special ballast arrangements in accordance with regulation 18.10 and is therefore exempted from the requirements of regulation 18

5.6 Limitation of size and arrangements of cargo tanks (regulation 26):

5.6.1 The ship is required to be constructed according to, and complies with, the requirements of regulation 26

5.6.2 The ship is required to be constructed according to, and complies with, the requirements of regulation 26.4 (see regulation 2.2)

- 5.7 Subdivision and Stability (regulation 28)
- 5.7.1 The ship is required to be constructed according to, and complies with, the requirements of regulation 28
- 5.7.2 Information and data required under regulation 28.5 have been supplied to the ship in an approved form
- 5.7.3 The ship is required to be constructed according to, and complies with the requirements of, regulation 27
- 5.7.4 Information and data required under regulation 27 for combination carriers have been supplied to the ship in written procedure approved by the Administration
- 5.8 Double hull construction:
- 5.8.1 The ship is required to be constructed according to regulation 19 and complies with the requirements of:
- .1 paragraph (3) (double-hull construction)
 - .2 paragraph (4) (mid-height deck tankers with double side construction)
 - .3 paragraph (5) (alternative method approved by the Marine Environment Protection Committee)
- 5.8.2 The ship is required to be constructed according to and complies with the requirements of regulation 19.6 (double bottom requirements)
- 5.8.3 The ship is not required to comply with the requirements of regulation 19
- 5.8.4 The ship is subject to regulation 20 and:
- .1 is required to comply with paragraphs 2 to 5, 7 and 8 of regulation 19 and regulation 28 in respect of paragraph 28.6 not later than
 - .2 is allowed to continue operation in accordance with regulation 20.5 until:
 - .3 is allowed to continue operation in accordance with regulation 20.7 until:
- 5.8.5 The ship is not subject to regulation 20
- 5.8.6 The ship is subject to regulation 21 and:
- .1 is required to comply with regulation 21.4 not later than
 - .2 is allowed to continue operation in accordance with regulation 21.5 until:
 - .3 is allowed to continue operation in accordance with regulation 21.6.1 until:
 - .4 is allowed to continue operation in accordance with regulation 21.6.2 until:
 - .5 is exempted from the provisions of regulation 21 accordance with regulation 21.7.2 until:
- 5.8.7 The ship is not subject to regulation 21

- 5.8.8 The ship is not subject to regulation 22 and:
- .1 complies with the requirements of regulation 22.2
 - .2 complies with the requirements of regulation 22.3
 - .3 complies with the requirements of regulation 22.5
- 5.8.9 The ship is not subject to regulation 22
- 5.9 Accidental outflow performance:
- 5.9.1 The ship complies with the requirements of regulation 23
- 6. Retention of oil on board (regulation 29, 31 and 32)**
- 6.1 Oil discharge monitoring and control system:
- 6.1.1 The ship comes under the category
oil tanker as defined in resolution A.496(XII) or A.586(14) *
- 6.1.2 Type oil discharge monitoring and control system has been approved in accordance with resolution MEPC.108(49)†
- 6.1.3 Type system comprises:
- .1 control unit
 - .2 computing unit
 - .3 calculating unit
- 6.1.4 Type system is
- .1 fitted with a starting interlock
 - .2 fitted with automatic stopping device
- 6.1.5 The oil content meter is approved under the terms of resolution A.393(X) or A.586(14)* or MEPC.108(49) (delete as appropriate) suitable for:
- .1 crude oil
 - .2 black products
 - .3 white products
 - .4 oil-like noxious liquid substances as listed in the attachment to the certificate

* For oil content meters installed on tankers built prior to 2 October 1986, refer to the Recommendation on international performance and test specifications for oily-water separating equipment and oil content meters adopted by the Organization by resolution A.393(X). For oil content meters as part of discharge monitoring and control systems installed on tankers built on or after 2 October 1986, refer to the Guidelines and specifications for oil discharge monitoring and control systems for oil tankers adopted by the Organization by resolution A.586(14). For oil content meters as part of discharge monitoring and control systems installed on tankers the keel of which are laid or are in a similar stage of construction on or after 1 January 2005, refer to the revised Guidelines and specifications for oil discharge monitoring and control systems for oil tankers adopted by the Organization by resolution MEPC.108(49).

† Oil tankers the keels of which are laid, or which are at a similar stage of construction, on or after 1 January 2005 should be fitted with a system approved under resolution MEPC.108(49)

6.1.6 The ship has been supplied with an operations manual for the oil discharge monitoring and control system

6.2 Slop tanks:

6.2.1 The ship is provided with dedicated slop tank(s) with the total capacity of m³, which is % of the oil carrying capacity, in accordance with:

.1 regulation 29.2.3

.2 regulation 29.2.3.1

.3 regulation 29.2.3.2

.4 regulation 29.2.3.3

6.2.2 Cargo tanks have been designated as slop tanks

6.3 Oil/water interface detectors:

6.3.1 The ship is provided with oil/water interface detectors approved under the terms of resolution MEPC.5(XIII)*

6.4 Exemptions form regulation 29, 31 and 32:

6.4.1 The ship is exempted from the requirements of regulation 2,9 31 and 32 in accordance with regulation 2.4

6.4.2 The ship is exempted from the requirements of regulation 29, 31 and 32 in accordance with regulation 2.2

6.5 Waiver of regulation :

6.5.1 The requirements of regulation 31 and 32 are waived in respect of the ship in accordance with regulation 3.5. The ship is engaged exclusively on:

.1 specific trade under regulation 2.5:

.....
.....
.....

.2 voyages within special area(s):

.....
.....
.....

* Refer to the Specification for oil/water interface detector adopted by Marine Environment Protection Committee of the Organization by resolution MEPC.5(XIII).

- .3 voyages within 50 miles of the nearest land outside special area(s) of 72 hours or less in duration restricted to:

.....
.....
.....

7. Pumping, piping and discharge arrangements (regulation 30)

7.1 The overboard discharge outlets for segregated ballast are located:

7.1.1 Above the waterline

7.1.2 Below the waterline

7.2 The overboard discharge outlets, other than the discharge manifold, for clean ballast are located:*

7.2.1 Above the waterline

7.2.2 Below the waterline

7.3 The overboard discharge outlets, other than the discharge manifold, for dirty ballast water or oil-contaminated water from cargo tank area are located*

7.3.1 Above waterline

7.3.2 Below waterline in conjunction with the part flow arrangements in compliance with regulation 30.6.5

7.3.3 Below the waterline

7.4 Discharge of oil from cargo pumps and oil lines (regulation 30.4 and 30.5):

7.4.1 Means to drain all cargo pumps and oil lines at the completion of cargo discharge:

.1 drainings capable of being discharged to cargo tank or slop tank

.2 for discharge ashore a special small-diameter line is provided

8. Shipboard oil pollution emergency plan (regulation 37)

8.1 The ship is provided with a shipboard oil pollution emergency plan in accordance with regulation 37

8.2 The ship is provided with a shipboard oil pollution emergency plan in accordance with regulation 37.3

* Only those outlets which can be monitored are to be indicated.

9. Exemption

9.1 Exemptions have been granted by the Administration from the requirements of chapter 3 of Annex I of the Convention in accordance with regulation 3.1 on those items listed under paragraph(s)

.....
.....
..... Of this record

10. Equivalents (regulation 5)

10.1 Equivalents have been approved by the Administration for certain requirements of Annex I on those items listed under paragraph(s)

..... Of this record

THIS IS TO CERTIFY that this Record is correct in all respects.

Issued at
(Place of issue of the Record)

.....
(Date of issue)

.....
(Signature of duly authorized officer issuing the Record)

(Seal or stamp of issuing authority, as appropriate)



**INTERNATIONAL POLLUTION
PREVENTION CERTIFICATE
FOR THE CARRIAGE OF NOXIOUS
LIQUID SUBSTANCES IN BULK**

Issued under the provisions of the
INTERNATIONAL CONVENTION FOR THE PREVENTION OF POLLUTION
FROM SHIPS, 1973,
as modified by the Protocol of 1978 relating thereto and as amended (hereinafter referred
to as »the Convention«)
under the authority of the Government of

The Kingdom of Denmark

by

DANISH MARITIME AUTHORITY

Particulars of ship

Name of ship

.....

Distinctive number or letters

.....

IMO Number *

.....

Port of registry

.....

Gross tonnage

.....

* Refer to IMO Ship Identification Scheme adopted by resolution A600(15).

THIS IS TO CERTIFY:

1. That the ship has been surveyed in accordance with regulation 8 of Annex II of the Convention.
2. That the survey showed that the structure, equipment, systems, fittings, arrangements and material of the ship and the condition thereof are in all respects satisfactory and that the ship complies with the applicable requirements of Annex II of the Convention.
3. That the ship has been provided with a manual in accordance with the Standards for the Procedures and Arrangements as called for by regulations 14 of Annex II of the Convention, and that the arrangements and equipment of the ship prescribed in the Manual are in all respects satisfactory and comply with the applicable requirements of the said Standards.
4. That the ship complies with the requirements of Annex II to MARPOL 73/78 for the carriage in bulk of the following Noxious Liquid substances, provided that all relevant provisions of Annex II are observed.

Noxious Liquid Substances	Conditions of carriage (tank numbers etc.)	Pollution Category
Continued on additional signed and dated sheets*		

This certificate is valid until subject to surveys in accordance with regulation 8 of Annex II of the Convention.

Completion date of the survey on which this certificate is based (dd/mm/yyyy):

Issued at
(Place of issue of certificate)

.....
(Date of issue)

.....
(Signature of authorized official issuing the certificate)

(Seal or stamp of the authority, as appropriate)

* Delete as appropriate.

Endorsement for annual and intermediate surveys

THIS IS TO CERTIFY that, at a survey required by regulation 8 of Annex II of the Convention, the ship was found to comply with the relevant provisions of the Convention.

Annual survey: Signed:
(Signature of authorized official)

Place:

Date: (dd/mm/yyyy)

(Seal or stamp of the authority, as appropriate)

Annual/Intermediate* survey: Signed:
(Signature of authorized official)

Place:

Date: (dd/mm/yyyy)

(Seal or stamp of the authority, as appropriate)

Annual/ Intermediate* survey: Signed:
(Signature of authorized official)

Place:

Date: (dd/mm/yyyy)

(Seal or stamp of the authority, as appropriate)

Annual survey: Signed:
(Signature of authorized official)

Place:

Date: (dd/mm/yyyy)

(Seal or stamp of the authority, as appropriate)

* Delete as appropriate.

Annual/intermediate survey in accordance with regulation 10.8.3

THIS IS TO CERTIFY that, at an annual/intermediate* survey in accordance with regulation 10.8.3 of the Annex II of the Convention, the ship was found to comply with the relevant provisions of the Convention.

Signed:
(Signature of authorized official)

Place:

Date: (dd/mm/yyyy)

(Seal or stamp of the issuing authority, as appropriate)

Endorsement to extend the certificate if valid for less than 5 years where regulation 10.3 applies

The ship complies with the relevant provisions of the Convention, and this certificate shall, in accordance with regulation 10.3 of the Annex II of the Convention, be accepted as valid
Until

.....

Signed:
(Signature of authorized official)

Place:

Date: (dd/mm/yyyy)

(Seal or stamp of the issuing authority, as appropriate)

Endorsement where the renewal survey has been completed and regulation 10.4 applies

The ship complies with the relevant provisions of the Convention, and this Certificate shall, in accordance with regulation 10.4 of Annex II of the Convention, be accepted as valid
Until

.....

Signed:
(Signature of authorized official)

Place:

Date: (dd/mm/yyyy)

(Seal or stamp of the issuing authority, as appropriate)

* Delete as appropriate.

**Endorsement to extend the validity of the Certificate until reaching the port of survey
or a period of grace where regulation 10.5 or 10.6* applies**

This Certificate shall, in accordance with regulation 10.5 or 10.6* of Annex II of the Convention,
be accepted as valid until

Signed:
(Signature of authorized official)

Place:

Date: (dd/mm/yyyy)

(Seal or stamp of the issuing authority, as appropriate)

Endorsement for advancement of anniversary date where regulation 10.8 applies

In accordance with regulation 10.8 of annex II of the convention, the new anniversary date

Is

Signed:
(Signature of authorized official)

Place:

Date: (dd/mm/yyyy)

(Seal or stamp of the issuing authority, as appropriate)

In accordance with regulation 10.8 of annex II of the convention, the new anniversary date

Is

Signed:
(Signature of authorized official)

Place:

Date: (dd/mm/yyyy)

(Seal or stamp of the issuing authority, as appropriate)

* Delete as appropriate.



INTERNATIONAL SEWAGE POLLUTION PREVENTION CERTIFICATE

Issued under the Provisions of the
INTERNATIONAL CONVENTION FOR THE PREVENTION OF POLLUTION
FROM SHIPS, 1973,
as modified by the Protocol of 1978 relating thereto, as amended (hereinafter referred to
as »the Convention«)
under the authority of the Government of:

The Kingdom of Denmark

by

DANISH MARITIME AUTHORITY

Particulars of ship

Name of ship

.....

Distinctive number or letters

.....

Port of registry

.....

Gross tonnage

.....

Number of persons which the ship
is certified to carry

.....

IMO Number *

.....

New/existing ship †

Date on which keel was laid or ship was at a similar stage of construction or, where applicable, date
on which work for a conversion or an alteration or modification of a major character was
commenced:

.....

* In accordance with resolution A.600(15) IMO Ship Identification Number Scheme.

† Delete as appropriate.

THIS IS TO CERTIFY:

1. That the ship is equipped with a sewage treatment plant/comminuter/holding tank and a discharge pipeline in compliance with regulation 9 and 10 of Annex IV of the Convention as follows^{*}:

1.1 Description of the sewage treatment plant*

Type of sewage treatment plant

Name of manufacturer

The sewage treatment plant is certified by the Administration to meet the effluent standards as provided for in resolution MEPC.2(VI)

1.2 Description of comminuter^{*}

Type of comminuter

Name of manufacturer

Standard of sewage after disinfection

1.3 Description of holding tank equipment^{*}

Total capacity of the holding tank m³

Location

1.4 A pipeline for discharge of sewage to a reception facility, fitted with a standard connection

2. That the ship has been surveyed in accordance with regulation 4 of Annex IV of the Convention

3. That the survey shows that the structure, equipment, systems, fittings, arrangements and material of the ship and the condition thereof are in all respects satisfactory and that the ship complies with the applicable requirements of Annex IV of the Convention

This certificate is valid until[†] subject to surveys in accordance with regulation 4 of Annex IV of the Convention

Completion date of survey on which this Certificate is based: (dd/mm/yyyy)

Issued at
(Place of issue of certificate)

.....
(Date of issue)

.....
(Signature of authorized official issuing the certificate)

(Seal or stamp of the issuing authority, as appropriate)

^{*} Delete as appropriate.

[†] Insert the date of expiry as specified by the Administration in accordance with regulation 8.1 of Annex IV of the Convention. The day and the month of this date correspond to the anniversary date as defined in regulation 1.8 of Annex IV of the Convention.

Endorsement to extend the Certificate if valid for less than 5 years where regulation 8.3 applies

The ship complies with the relevant provisions of the Convention, and this certificate shall, in accordance with regulation 8.3 of Annex IV of the Convention, be accepted as valid until

Signed:

(Signature of authorized official)

Place:

Date: (dd/mm/yyyy)

(Seal or stamp of the issuing authority, as appropriate)

Endorsement where the renewal survey has been completed and regulation 8.4 applies

The ship complies with the relevant provisions of the Convention, and this certificate shall, in accordance with regulation 8.4 of Annex IV of the Convention, be accepted as valid until

Signed:

(Signature of authorized official)

Place:

Date: (dd/mm/yyyy)

(Seal or stamp of the issuing authority, as appropriate)

Endorsement to extend the validity of the Certificate until reaching the port of survey or a period of grace where regulation 8.5 or 8.6 applies

This Certificate shall, in accordance with regulation 8.5 or 8.6* of Annex IV of the Convention, be accepted as valid until

Signed:

(Signature of authorized official)

Place:

Date: (dd/mm/yyyy)

(Seal or stamp of the issuing authority, as appropriate)

* Delete as appropriate.



INTERNATIONAL AIR POLLUTION PREVENTION CERTIFICATE

(Note: This certificate shall be supplemented by a
Record of Construction and Equipment)

Issued under the provisions of the
Protocol of 1997 to amend the INTERNATIONAL CONVENTION FOR THE
PREVENTION OF POLLUTION FROM SHIPS, 1973, as modified of the Protocol of
1978 related thereto, and as amended by resolution MEPC.132(53), (hereinafter referred
to as »the Convention«)
under the authority of the Government of:

The Kingdom of Denmark

by

DANISH MARITIME AUTHORITY

Particulars of ship

Name of ship

.....

Distinctive number or letters

.....

Port of registry

.....

Gross tonnage

.....

IMO Number¹

.....

Type of ship:

Tanker

Ship other than a tanker

¹ In accordance with IMO ship identification number scheme adopted by the Organisation by resolution A.600(15).

THIS IS TO CERTIFY:

1. That the ship has been surveyed in accordance with regulation 5 of Annex VI of the Convention; and
2. That the survey shows that the equipment, systems, fittings, arrangements and materials fully comply with the applicable requirements of Annex VI of the Convention.

Completion date of the survey on which this certificate is based: (dd/mm/yyyy)

This certificate is valid until²
subject to surveys in accordance with regulation 5 of Annex VI of the Convention.

Issued at
(Place of issue of certificate)

.....
(Date of issue)

.....
(Signature of authorized official issuing the certificate)

(Seal or stamp of the issuing authority, as appropriate)

² Insert the date of expiry as specified by the Administration in accordance with regulation 9.1 of Annex VI of the Convention. The day and the month of this date correspond to the anniversary date as defined in regulation 2.3 of Annex VI of the Convention, unless amended in accordance with regulation 9.8 of Annex VI of the Convention.

Endorsement for annual and intermediate surveys

THIS IS TO CERTIFY that at a survey required by regulation 5 of Annex VI of the Convention the ship was found to comply with the relevant provisions of the Convention.

Annual survey: Signed:
(Signature of authorized official)

Place:

Date:

(Seal or stamp of the issuing authority, as appropriate)

Annual/Intermediate* survey: Signed:
(Signature of authorized official)

Place:

Date:

(Seal or stamp of the issuing authority, as appropriate)

Annual/Intermediate* survey: Signed:
(Signature of authorized official)

Place:

Date:

(Seal or stamp of the issuing authority, as appropriate)

Annual survey: Signed:
(Signature of authorized official)

Place:

Date:

(Seal or stamp of the issuing authority, as appropriate)

* Delete as appropriate.

Annual/intermediate survey in accordance with regulation 9.8.3

THIS IS TO CERTIFY that, at an annual/intermediate* survey in accordance with regulation 9.8.3 of the Annex VI of the Convention, the ship was found to comply with the relevant provisions of the Convention:

Signed:
(Signature of authorized official)

Place:

Date:

(Seal or stamp of the issuing authority, as appropriate)

Endorsement to extend the certificate if valid for less than 5 years where regulation 9.3 applies

The ship complies with the relevant provisions of the Convention, and this certificate shall, in accordance with regulation 9.3 of Annex VI of the Convention, be accepted as valid until

.....

Signed:
(Signature of authorized official)

Place:

Date:

(Seal or stamp of the issuing authority, as appropriate)

Endorsement where the renewal survey has been completed and regulation 9.4 applies

The ship complies with the relevant provisions of the Convention, and this Certificate shall, in accordance with regulation 9.4 of Annex VI of the Convention, be accepted as valid until

.....

Signed:
(Signature of authorized official)

Place:

Date:

(Seal or stamp of the issuing authority, as appropriate)

* Delete as appropriate.

**Endorsement to extend the validity of the Certificate until reaching the port of survey
or a period of grace where regulation 9.5 or 9.6 applies**

This Certificate shall, in accordance with regulation 9.5 or 9.6* of Annex VI of the Convention, be
accepted as valid until

.....

Signed:
(Signature of authorized official)

Place:

Date:

(Seal or stamp of the issuing authority, as appropriate)

Endorsement for advancement of anniversary date where regulation 9.8 applies

In accordance with regulation 9.8 of Annex VI of the Convention, the new anniversary date
is

.....

Signed:
(Signature of authorized official)

Place:

Date:

(Seal or stamp of the issuing authority, as appropriate)

In accordance with regulation 9.8 of Annex VI of the Convention, the new anniversary date
is

.....

Signed:
(Signature of authorized official)

Place:

Date:

(Seal or stamp of the issuing authority, as appropriate)

* Delete as appropriate.



Supplement to the International Air Pollution Prevention Certificate
(IAPP Certificate)

**RECORD OF CONSTRUCTION AND
EQUIPMENT**

Notes:

1. This Record shall be permanently attached to the IAPP Certificate. The IAPP Certificate shall be available on board the ship at all times.
2. The entries shall be at least in English, French or Spanish. If an official language of the issuing country is also used, this shall prevail in case of a dispute or discrepancy.
3. Entries in boxes shall be made by inserting either a cross (x) for the answer »yes« and »applicable« or a dash (-) for the answers »no« and »not applicable« as appropriate.
4. Unless otherwise stated, regulations mentioned in this Record refer to regulations of Annex VI of the Convention and resolutions or circulars refer to those adopted by the International Maritime Organization.

1. Particulars of ship

1.1 Name of ship

1.2 IMO number

1.3 Date on which keel was laid or ship
was at a similar stage of construction

1.4 Length (L) # metres

completed only in respect of ships constructed on or after 1 January 2016, which are specially designed, and used solely, for recreational purposes and to which, in accordance with regulation 13.5.2.1, the NO_x emission limit as given by regulation 13.5.1.1, will not apply.

2. Control of emissions from ships

2.1 Ozone-depleting substances (regulation 12)

2.1.1 The following fire-extinguishing systems, other systems and equipment containing ozone depleting substances, other than hydro-chlorofluorocarbons, installed before 19 May 2005 may continue in service:

System equipment:	Location on board:	Substance

2.1.2 The following systems and equipment containing hydro-chlorofluorocarbons (BFCs) installed before 1 January 2020 may continue in service:

System equipment:	Location on board:	Substance

2.2 Nitrogen oxides (No_x) (regulation 13):

2.2.1 The following marine diesel engines installed on this ship comply with the applicable emission limit of regulation 13 in accordance with the revised NO_x Technical Code 2008:

		Engine #1	Engine #2	Engine #3	Engine #4	Engine #5	Engine #6
Manufacturer and model							
Serial number							
Use							
Power output (kW)							
Rated speed (rpm)							
Date of installation (dd/mm/yyyy)							
Date of major conversion (dd/mm/yyyy)	Acc. to reg. 13.2.2						
	Acc. to reg. 13.2.3						
Exempted by reg. 13.1.1.2		<input type="checkbox"/>	<input type="checkbox"/>	<input type="checkbox"/>	<input type="checkbox"/>	<input type="checkbox"/>	<input type="checkbox"/>
Tier I reg. 13.3		<input type="checkbox"/>	<input type="checkbox"/>	<input type="checkbox"/>	<input type="checkbox"/>	<input type="checkbox"/>	<input type="checkbox"/>
Tier II reg. 13.2		<input type="checkbox"/>	<input type="checkbox"/>	<input type="checkbox"/>	<input type="checkbox"/>	<input type="checkbox"/>	<input type="checkbox"/>
Tier II reg. 13.222 or 13.5.2		<input type="checkbox"/>	<input type="checkbox"/>	<input type="checkbox"/>	<input type="checkbox"/>	<input type="checkbox"/>	<input type="checkbox"/>
Tier III reg. 13.5.1.1		<input type="checkbox"/>	<input type="checkbox"/>	<input type="checkbox"/>	<input type="checkbox"/>	<input type="checkbox"/>	<input type="checkbox"/>
Approved method exists		<input type="checkbox"/>	<input type="checkbox"/>	<input type="checkbox"/>	<input type="checkbox"/>	<input type="checkbox"/>	<input type="checkbox"/>

Approved method not commercially available	<input type="checkbox"/>	<input type="checkbox"/>	<input type="checkbox"/>	<input type="checkbox"/>	<input type="checkbox"/>	<input type="checkbox"/>
Approved method installed	<input type="checkbox"/>	<input type="checkbox"/>	<input type="checkbox"/>	<input type="checkbox"/>	<input type="checkbox"/>	<input type="checkbox"/>

2.2.2 The following diesel engines with power output greater than 130 kW, and which underwent major conversion per regulation 13(2) on or after 1 January 2000, comply with the emission standards of regulation 13(3)(a) in accordance with the NO_x Technical Code:

Manufacturer and model	Serial number	Use	Power output (kW)	Rated speed (rpm)

2.3 Sulphur oxides (SO_x) (regulation 14)

2.3.1 When the ship operates within an SO_x emission control area specified in regulation 14.3, the ship uses:

.1 fuel oil with a sulphur content that does not exceed the applicable limit value as documented by bunker delivery notes; or

.2 an equivalent arrangement approved in accordance with regulation 4.1 as listed in 2.6

2.4 Volatile organic compounds (VOCs) (regulation 15)

2.4.1 The tanker has a vapour collection system installed and approved in accordance with MSC/Circ.585

2.4.1.1 For a tanker carrying crude oil, there is an approved VOC Management Plan

2.4.1.2 VOC Management Plan approval reference

2.5 *Shipboard incineration (regulation 16)*

.1 installed on or after 1 January 2000 which complies with resolution MEPC.76(40) as amended

.2 installed before 1 January 2000 which complies with

.2.1 resolution MEPC.59(33)

.2.2 resolution MEPC.76(40)

2.6 *Equivalentents (regulation 4)*

The ship has been allowed to use the following fitting, material, appliance or apparatus to be fitted in a ship or other procedures, alternative fuel oils, or compliance methods used as an alternative to that required by this Annex:

System or equipment:	Equivalent used	Approval reference

THIS IS TO CERTIFY that this Record is correct in all respects.

Issued at

(Place of issue of the Record)

(dd/mm/yyyy)
.....

(Date of issue)

.....
(Signature of duly authorized officer issuing the Record)

(Seal or stamp of issuing authority, as appropriate)

A N N E X 2

National certificates

National Cargo Ship Safety Certificate	1
Nationalt sikkerhedscertifikat for lastskibe	
Record of Equipment (Form N)	5
Udrustningsfortegnelse	



NATIONAL CARGO SHIP SAFETY CERTIFICATE

NATIONALT SIKKERHEDSCERTIFIKAT FOR LASTSKIBE

This certificate shall be supplemented by a Record of Equipment
Dette certifikat skal suppleres med en udrustningsfortegnelse

Issued under the provisions of the
Danish regulations for cargo ships of less than 500 gross tonnage
(Notice B from the Danish Maritime Authority)

under the authority of the Government of

DENMARK

by **DANISH MARITIME AUTHORITY**

Name of ship	Distinctive number or letters	IMO number	Port of registry	Gross tonnage

Type of ship	Length of ship	Minimum freeboard ³	Date on which keel was laid or, where applicable, date on which work for a conversion or an alteration or modification of a major character was commenced

THIS IS TO CERTIFY:

That the ship has been surveyed in accordance with the requirements of regulations I/8-1, I/9-1, I/10-1 and II-5N/13 of the current regulations.

That the survey showed that:

- 1 The condition of the structure, machinery and equipment as defined in the above regulations was satisfactory and the ship complied with the applicable requirements of chapters II-1 and II-2 of the current regulations (other than those relating to fire safety systems and appliances and fire control plans);
- 2 The ship complied with the requirements of the current regulations as regards fire-extinguishing and safety systems and appliances;
- 3 The life-saving appliances and the equipment of the lifeboats, liferafts and rescue boats were provided in accordance with the requirements of the current regulations;
- 4 The ship complied with the requirements of the current regulations as regards radio installations.

¹ The above gross tonnage has been determined in accordance with the international Convention on Tonnage Measurement, 1969.

² The above gross tonnage has been determined by the authorities of the Administration in accordance with the National Tonnage Rules which were in force prior to the coming into force for existing ships of the International Tonnage Measurement of Ships, 1969.

³ For ships less than 24 meters in length only

(For ships of 300 gross tonnage and above a separate Cargo Ship Safety Radio Certificate is issued).

- 5 The functioning of the radio installation used in life-saving appliances complied with the requirements of the current regulations;
- 6 The ship complied with the requirements of the current regulations as regards shipborne navigational equipment, means of embarkation for pilots and nautical publications;
- 7 The ship was provided with navigation lights, shapes, means of making sound signals and distress signals in accordance with the requirements of the current regulations and International Regulations for Preventing Collisions at Sea in force;
- 8 In all other respects, the ship complied with the relevant requirements of the current regulations.

Exemptions have/have not been granted⁴.

The ship is, under the authority of the current regulations, exempted from the requirements of:

Conditions, if any, for which the exemption is granted:

Voyages, if any, for which the exemption is granted:

This certificate is valid until subject to the inspections of the outside of the ship's bottom in accordance with regulation I/10-1 of the current regulations.

Place of Issue

Date of issue

(Signature of authorized official issuing the certificate)

(Seal or stamp of the issuing authority, as appropriate)

⁴ Delete as appropriate

Endorsement for inspections of the outside of the ship's bottom

For classed ships: The hull certificate or the safe construction certificate from the current classification society shall substitute the endorsements for inspections of the outside of the ship's bottom.

THIS IS TO CERTIFY that, at a survey required by regulation I/10-1 of the current regulations, the ship was found to comply with the relevant requirements of the current regulations.

First inspection:

Signed:
(Signature of authorized official)

Place:

Date:

(Seal or stamp of the authority, as appropriate)

Second inspection:

Signed:
(Signature of authorized official)

Place:

Date:

(Seal or stamp of the authority, as appropriate)

Endorsement for intermediate surveys relating to life-saving appliances and other equipment referred to in paragraphs 3, 4, 6, and 7 of this certificate.⁵

Not applicable to classed ships.

THIS IS TO CERTIFY that, at a survey required by regulation I/8-1 of the current regulations, the ship was found to comply with the relevant requirements of the regulations.

Periodical survey:

Signed:
(Signature of authorized official)

Place:

Date:

(Seal or stamp of the authority, as appropriate)

⁵ Cargo ships with a gross tonnage below 250 are not subject to periodical surveys during a five-year period. Cargo ships with a gross tonnage of 250 or more but below 500 are subject to a periodical survey not more than 33 months and at least 27 months before the expiry of the certificate. However, endorsement is only provided for unclassed ships.

Endorsement for annual surveys relating to radio installations on cargo ships in international trade and with a gross tonnage below 300 referred to in paragraphs 5 and 7 of this certificate. Instead of the signature of an authorized official, a written statement from the Danish Maritime Authority or a duly authorized official can be enclosed to this certificate.

THIS IS TO CERTIFY that, at a survey required by regulation I/9-1 of the current regulations, the ship was found to comply with the relevant requirements of the current regulations.

Annual survey: Signed:
(Signature of authorized official)
Place:
Date:
(Seal or stamp of the authority, as appropriate)

Annual survey: Signed:
(Signature of authorized official)
Place:
Date:
(Seal or stamp of the authority, as appropriate)

Annual survey: Signed:
(Signature of authorized official)
Place:
Date:
(Seal or stamp of the authority, as appropriate)

Annual survey: Signed:
(Signature of authorized official)
Place:
Date:
(Seal or stamp of the authority, as appropriate)

Endorsement to extend the validity of the certificate until the ship reaches the port of survey or for a period of grace where regulation 14-1 applies. Instead of the signature of an authorized official, a written statement from the Danish Maritime Authority or a duly authorized official can be enclosed to this certificate.

This certificate shall, in accordance with regulation 14-1 of the current regulation, be accepted as valid until _____.

Signed:
(Signature of authorized official)
Place:
Date:
(Seal or stamp of the authority, as appropriate)

Bilag 2 - 4

Dato formatet på dette certifikat er: dd-mm-åååå (The date forming used on this certificate is: dd-mm-yyyy)



Record of equipment for the Cargo Ship Safety Certificate (Form N)

This Record shall be permanently attached to the Cargo Ship Safety Certificate
Denne fortegnelse skal være permanent tilknyttet Sikkerhedscertifikat for Lastskibe

RECORD OF EQUIPMENT FOR COMPLIANCE WITH Udrustningsfortegnelse for opfyldelsen af THE DANISH REGULATIONS FOR CARGO SHIPS OF danske regler for lastskibe LESS THAN 500 GROSS TONNAGE med en bruttotonnage på under 500 (Notice from the Danish Maritime Authority, B) (Meddelelser fra Søfartsstyrelsen, B)

<i>Name of ship</i>	<i>Distinctive number or letters</i>	<i>IMO number</i>	<i>Port of registry</i>

Details of life-saving appliances

1 Total number of persons for which life-saving appliances are provided:		Port side	Starboard side
2	Total number of lifeboats		
2.1	Total number of persons accommodated by them		
2.2	Number of self-righting partially enclosed lifeboats (LSA Code, Reg. 4.5) .		
2.3	Number of totally enclosed lifeboats (LSA Code, Reg. 4.6)		
2.4	Number of lifeboats with a self-contained air support system (LSA Code, Reg. 4.8)		
2.5	Number of fire-protected lifeboats (LSA Code, Reg. 4.9)		
2.6	Other lifeboats:		
2.6.1	Number		
2.6.2	Type		
2.7	Number of free-fall lifeboats (LSA Code, Reg. 4.7)		
2.7.1	Totally enclosed (LSA Code, Reg. 4.6)		
2.7.2	Self-contained (LSA Code, Reg. 4.8)		
2.7.3	Fire-protected (LSA Code, Reg. 4.9)		
3	Number of motor lifeboats (included in the total lifeboats shown above)		
3.1	Number of lifeboats fitted with searchlights		
4	Total number of other boats *		
4.1	Rescue Boat (LSA Code, Reg. 5.1)		
4.2	MOB boat (National regulation, Notice C)		

* excluding working boats

Dato formatet på dette certifikat er: dd-mm-åååå (The date formatting used on this certificate is: dd-mm-yyyy)

4.3	Number of boats included in the total lifeboats shown above	
4.4	Open Boats 1,5 m ³ (National regulation, Order no. 173)	
4.5	Open Boats 2,85 m ³ (National regulation, Order no. 173)	
5	Liferafts	
5.1	Those for which approved launching appliances are required	
5.1.1	Number of liferafts	
5.1.2	Number of persons accommodated by them	
5.2	Those for which approved launching appliances are not Required	
5.2.1	Number of liferafts	
5.2.2	Number of persons accommodated by them	
5.3	Number of liferafts required by regulation III/26.1.4	
6	Number of lifebuoys	
7	Number of lifejackets	
8	Immersion suits	
8.1	Total number	
8.2	Number of suits complying with the requirements for lifejackets	
9	Number of thermal protective aids	
10	Radio installations used in life-saving appliances	
10.1	Number of radar transponders	
10.2	Number of two-way VHF radiotelephone apparatus	
11	Pyrotechnic	
11.1	Parachute signals	
11.2	Handflares	
11.3	Line throwing appliance	

Details of radio facilities

Cargo ships of 300 Gross Tonnage and above in international trade, is issued a separate Cargo Ship Safety Radio Certificate supplemented by a record of equipment of radio facilities (Form R)

Minimum number of persons with required Qualifications to operate the radio Installations:	
GMDSS sea areas in which the ship is certified to operate	

	Item	Actual provision
1	Primary systems	
1.1	VHF radio installation	
1.1.1	DSC encoder	
1.1.2	DSC watch receiver	
1.1.3	Radiotelephony	
1.2	MF radio installation	
1.2.1	DSC encoder	
1.2.2	DSC watch receiver	
1.2.3	Radiotelephony	
1.3	MF/HF radio installation	
1.3.1	DSC encoder	
1.3.2	DSC watch receiver	

1.3.3	Radiotelephony	
1.3.4	Direct-printing telegraphy	
1.4	INMARSAT ship earth station	
2	Secondary means of alerting	
3	Reception of maritime safety information	
3.1	NAVTEX receiver	
3.2	EGC receiver	
3.3	HF direct-printing radiotelegraphy receiver	
4	Satellite EPIRB	
4.1	COSPAS/SARSAT	
4.2	INMARSAT	
5	VHF EPIRB	
6	Ship's radar transponder	

Methods used to ensure availability of radio facilities (regulations IV/15.6 and 15.7)

1	Duplication of equipment	
2	Shore-based maintenance	
3	At-sea maintenance capability	

Details of navigational systems and equipment

Item	Actual provision
1 Standard magnetic compass	
2 Bearing device*	
3 Means of correcting heading and bearings	
4 Nautical charts and publications*	
5 Back up arrangement for charts and publications if by electronic means*	
6 Position by automatic means	
7 Radar reflector*	
8 Sound reception system (Bridge totally closed)*	
9 Telephone to emergency steering position*	
10 Spare magnetic compass or gyro compass*	
11 Signal lamp*	
12 Echo sounding device*	
13 Radar*	
14 Electronic plotting aid*	
15 Speed and distance measuring device (through the water)*	
16 Properly adjusted transmitting heading device (THD)*	
17 Automatic identification system (AIS)	
18 Illustrated table of life-saving signals	
19 Internal Code of signals	
20 Signal flags	
21 Bridge watch alarm	

* Alternative means of meeting this requirement are permitted under SOLAS chapter V

Details of fire fighting equipment

1. Firepumps:			
1.1 Permanently installed, pump no. 1: capacity	m ³ /h	pressure:	bar
Permanently installed, pump no. 2: capacity	m ³ /h	pressure:	bar
1.2 Portable pump: capacity	m ³ /h	pressure:	bar

Dato formatet på dette certifikat er: dd-mm-åååå (The date formatting used on this certificate is: dd-mm-yyyy)

2. Hydrants, hoses and nozzles				
		In accommodation	On deck	In engine room
	Hydrants			
	Hoses			
	Nozzles			
3. Portable extinguishers				
		In accommodation	On deck	In engine room
	Water			
	Foam			
	Powder			
	CO ₂			
	Andet			
3.1	No. of spare charges		No. of spare extinguishers	
4 Fireman's outfit				
Protective clothing, complete				
Breathing apparatus, no. incl. bottles		No of spare bottles		
Capacity of each bottle	Volume:	L.	Pressure	Bar
Emergency Escape Breathing Apparatus (EEBD)				

Details of navigation lights, signal figures and sound signal appliances

1. Lights	Main	Spare
1.1 Mast head, sides, stern, and anchor		
1.2 Not Under Command (NUC)		
1.3 Restricted Ability to Manoeuvre (RAM)		
1.4 Passage light		
1.5 Other(specify) :		
2. Signal figures	Amount	
2.1 Ball		
2.2 Conical shape		
2.3 Cylinder		
2.4 Diamond		
3 Sound signal appliances	Amount	
3.1 Whistle		
3.2 Bell		

Miscellaneous

	Amount
1 Hoistable stretcher	
2 Gangway/accommodation ladder	
3 Flag of nationality	
4 Maritime standard expressions	

THIS IS TO CERTIFY that this Record is correct in all respects

Issued at		Date	
-----------	--	------	--

(Place of issue of the Record)

(Seal or stamp of the issuing authority, as appropriate)

(Signature of duly authorized official issuing the record)